



This PDF is generated from authoritative online content, and is provided for convenience only. This PDF cannot be used for legal purposes. For authoritative understanding of what is and is not supported, always use the online content. To copy code samples, always use the online content.

Composer Help

Composer 8.1.5

Table of Contents

Welcome	13
Composer Overview	16
Getting Help	19
Composer Installation Video	20
Composer Quick Start	21
Eclipse Workbench	35
Introduction to Composer	36
Software Prerequisites	39
Interface Overview	40
Using the Interface	45
Connection Links	47
Composer Code Editors	49
Enabling/Disabling Functionality	51
Hiding File Types and Blocks	52
Localization	54
Composer Compared to IRD	56
Getting Started with Composer	62
Running Composer for the First Time	63
Software Updates Functionality (Plugins)	65
Integrating with Source Control	67
Project Types and Directories	74
Project Properties	91
Multiple User Environments	110
Security Configuration	111
Upgrading Projects and Diagrams	112
Working with Diagram Layouts	122
Accessing the Editors and Templates	124
Keyboard Shortcuts	127
Default Logging	129
IRD Functionality Included in Composer	130
Diagram Search	134
Masking Sensitive Information in Composer Tomcat Logs	139
Composer Menus	141
File Menu	142
Edit Menu	144

Diagram Menu	145
Navigate Menu	148
Search Menu	150
Project Menu	151
Run Menu	153
Configuration Server Menu	156
Window Menu	157
Help Menu	159
Canvas Shortcut Menu	160
Palette Group Menu	162
Composer Toolbars and Views	163
Toolbars Overview	164
Main Toolbar	165
View Toolbars	171
Perspective Switcher Toolbar	183
Trimstack Toolar	185
Debugging Toolbars	186
Minimizing and Restoring Views	193
Strategy Manager View	195
Voice Applications and Callflows	197
Getting Started with Voice Applications	198
Callflow Post Installation	199
Working with Java Composer Projects	203
Working with .NET Composer Projects	204
Preferences for Voice Applications	206
CCXML File Preferences	207
Diagram Preferences	209
GAX Server Preferences	213
GRXML File Preferences	214
VXML File Preferences	216
GVP Debugger Preferences	218
IIS.NET Preferences	219
Setting Context Services Preferences	220
Time Zone Preferences	224
Tomcat Preferences	225
XML Preferences	226
Creating Voice Apps for GVP	227

What is GVP and How Do Voice Apps Work	228
Creating CCXML Applications	231
Creating VXML Applications	232
Hello World Sample	238
Callflow Blocks	241
Variables in Callflows	242
VXML Properties	246
Voice Block Palette Reference	264
Voice Blocks Basic	266
Assign Common Block	268
Branching Common Block	272
Disconnect Block	276
End FCR Block	278
Entry Block and Variables	280
Exit Block	289
GoTo Block	291
Grammar Menu Block	295
Input Block	302
Log Common Block	315
Looping Common Block	317
Menu Block	322
Prompt Block	331
Raise Event Block	335
Record Block	337
Release ASR Engine Block	344
Script Block	346
Set Language Block	348
SNMP Block	350
Start FCR Block	352
Subdialog Block	355
Transfer Block	361
VXML Form Block	372
Voice Database Blocks	374
DB Data Block	376
Database Input Block	377
DB Prompt Block	383
Working with Database Blocks	386

Supported SQL Datatypes	399
Voice CTI Blocks	401
CTI Scenarios	402
Get Access Number	405
Interaction Data Block	408
Route Request Block	411
Statistics Block	419
ICM Interaction Data Block	424
ICM Route Request Block	426
Working with CTI Applications	435
Voice External Message Blocks	441
Receive Block	442
Send Data Block	444
Send Event Block	447
Send Info Block	449
Reporting Blocks	451
Action Start Block	452
Action End Block	455
Set Call Data Block	458
Set Call Result Block	460
Genesys Voice Platform (GVP) Blocks	463
IVR Recording Block	464
Using Voice Blocks	467
Working with Grammar Builder	468
Working with CTI Applications	435
Working with Prompts	480
Connection Pooling	491
Common Properties for Callflow Blocks	498
Routing Applications and Workflows	510
Routing FAQs	511
Getting Started with Route Applications	520
IRD Functionality Included in Composer	130
Workflow Post Installation	525
Upgrading Workflows	530
Preferences for Routing Applications	531
Business Rule Preferences	532
Configuration Server Preferences	533

Diagram Preferences	209
Setting Context Services Preferences	220
Customizer Preferences	542
ORS Debugger Preferences	544
GAX Server Preferences	213
Help Preferences	546
IIS.NET Preferences	219
Orchestration Preferences	548
Orchestration Options	549
Orchestration Extensions	552
Detaching Interactions	553
SCXML File Preferences	558
Security Preferences	560
Tomcat Preferences	225
Introduction to Routing Workflows	562
What is a Routing Workflow?	563
Architecture Diagram for Workflows	565
Workflow Example and Palette	567
SCXML File Editor	568
Sessions and Interactions	570
Interaction Process Diagrams	571
Creating Routing Applications	574
	575
Starting SCXML Page	577
Creating a New Project	578
Creating the IPD	580
Creating a New Workflow Diagram	584
Using the SCXML Editor	585
Using SCXML Templates	586
Your First Application: Routing Based on DNIS or ANI	587
Using URS and ORS Functions	597
Routing Block Palette Reference	600
Interaction Process Diagram Blocks	602
IPD Differences Voice and Multimedia	603
Starting a New IPD	604
Interaction Queue Block	612
Adding an Interaction Queue	616

Interaction Queue Views	617
Media Server Block	625
Workflow Block	629
Workbin Block	633
Flow Control Blocks	637
Workflow Generated Blocks	638
Linking IPDs with Workflows	641
Publishing Updates	642
Route Flow Control Blocks	650
Assign Common Block	652
Attach Block	656
Begin Parallel Block	658
Branching Common Block	661
Cancel Event Block	664
Detach Block	666
Disconnect Block Routing	668
ECMAScript Block	670
End Parallel Block	675
Entry Block and Variables	677
Exit Block Routing	685
Response Block	688
Log Common Block	692
Looping Common Block	694
Raise Event Block	699
SCXML State Block	702
Subroutine Block	710
User Data Block	715
Wait Event Block	720
Routing Blocks	723
Cancel Block	724
Default Routing Block	726
Force Route Block	729
Queue Interaction Block	734
Query Block	738
Route Interaction Block	741
Routing Rule Block	753
Set Ideal Agent Block	757

Single Step Transfer Block	760
Stop Interaction Block	763
Target Block	768
Update Block	784
Percent and Conditional Routing	786
Routing to the Last Called Agent	788
Voice Treatment Blocks	790
Composer Equivalent to IRD Treatment	792
Cancel Call Block	795
Create User Announcement Block	797
Delete User Announcement Block	802
IVR Block	804
Pause Block	808
Play Application Block	810
Play Sound Block	816
Play Message Block	820
Set Default Route	824
User Input Block	826
Single Session Treatments	835
eServices Blocks	841
Composer Equivalent to IRD Multimedia	844
Analyze Block	847
Chat Transcript Block	857
Classify Interaction Block	862
Create E-mail Block	867
Create Interaction Block	872
Create SMS Block	877
Email Forward Block	881
Email Response Block	887
Find Interactions Block	893
Identify Contact Block	896
Render Message Block	900
Screen Interaction Block	904
Send Email Block	910
Send SMS Block	914
Set Agent State Block	917
Update Contact Block	926

Update Interaction Block	929
Update UCS Record	932
Using eServices Blocks	937
Handling eServices Switchovers	943
How To: Automate an SMS Response to a Customer Call	945
Common Properties for Workflow Blocks	955
Social Media Blocks	971
Twitter Block	974
Facebook Block	979
Other Workflow Functionality	985
Variables Project and Workflow	986
User Data	994
Custom Events	997
Skill Expression Builder	998
List Objects Manager	1004
Statistics Manager and Builder	1009
Orchestration Extensions	552
Service Level Routing	1014
Exception Events	1017
Working with URS Functions	1027
Working with URS API Calls	1028
	1029
Code Generation	1030
Custom Blocks	1032
Customization Manager	1035
Diagram Preferences	209
Exception Events	1017
Expression Builder	1052
GAX Server Preferences	1064
Getting Using Email Addresses	1065
Import and Export	1069
Link Tool	1072
Locales	1073
Time Zone Preferences	224
Using User Data	1083
Variables Mapping	1086
	1087

Context Services Common Blocks	1089
Context Services 8.5 Support	1091
Context Services and Composer	1092
Associate Service Block	1094
Complete Service Block	1098
Complete State Block	1101
Create Customer Block	1104
Complete Task Block	1107
Enter State Block	1110
Identify Customer Block	1114
Query Customer Block	1119
Query Services Block	1122
Query States Block	1128
Query Tasks Block	1132
Start Service Block	1135
Start Task Block	1139
Update Customer Block	1143
Using Context Services Blocks	1146
Common Properties Context Services	1147
Online and Offline Modes	1153
Runtime Configuration	1154
Context Services Exception Events	1157
Outbound Common Blocks	1158
Add Record Block	1159
Cancel Record Block	1166
Do Not Call Block	1169
Record Processed Block	1172
Reschedule Record Block	1175
Update Record Block	1178
Server-Side Common Blocks	1181
Backend Common Block	1186
Business Rule Common Block	1190
DB Data Common Block	1201
External Service Block	1207
NDM Block	1212
HTTP Rest Block	1216
OPM Common Block	1225

TLib Block	1228
URS Function Block	1229
Web Request Common Block	1235
Web Service Common Block	1246
Web Service Stubbing	1266
Web Service SOAP Messages	1268
Signed SOAP Requests	1271
Connection and Read Timeout	1273
Server-Side Troubleshooting	1274
Sample Applications and Templates	1276
Project Templates	1277
Diagram Templates	1278
GVP Voice Project Templates	1281
Application Metrics Collection Project Template	1292
Integrated Voice Route Project Templates	1300
Routing Templates and Samples	1307
Context Services Template	1309
Database Query Result Template	1314
Forward to External Resource Template	1316
Route After Autoresponse Template	1318
Routing Based on Variables Template	1321
Routing Based on Date and Time Sample	1323
Routing Based on a Statistic Sample	1327
Routing Based on Percent Allocation	1330
Routing Using Web Request Sample	1333
Last Called Agent Routing	1336
Validation, Debugging, and Deployment	1345
Validation	1346
Debugging Routing Applications	1349
Debugging Voice Applications	1362
Deploying Composer Applications	1378
Best Practices	1392
Troubleshooting	1394
General Troubleshooting	1396
	1397
Bundled Help contents are always in English	1398
Chat Messages in Queues	1399

Checkin Error During Source Code Integration	1401
Composer Project Not Deployed on Tomcat	1402
Composer Project Not Currently Deployed	1403
Connection Profile and ASCII Characters	1404
Chinese Characters Do Not Display	1405
Connection to a Database Fails	1406
Context Services URL Message	1408
CTI Block Issues	1409
Debugging Failure	1410
Deployment Failure on IIS	1411
DOTNet (.NET) Project Issues	1412
Failed to Deploy Message	1414
Installation and Uninstallation	1415
JSON objects and JavaScript keywords	1416
	1417
Plugin Installation	1418
Proxy Configurations .NET Composer Projects	1419
Request Form Error Message	1420
SCXML Editor Element Not Bound Message	1421
Server-Side Troubleshooting	1274
Slow Response Time	1424
Stored Procedure Helper and DB Data Block	1425
Tomcat Service Failed to Start	1426
Test Calls Do Not Work	1427
Upgrade Errors and Error Messages	1429
Validation Error upon publishing IPD	1431
Web Service Block Issues	1432
Workflow Does Not Compile	1439
Workspace in Use or Cannot be Created	1440
Workspace Files Not in Sync	1441
Tomcat Service - File Permissions Issue	1442
Links to Useful Resources	1443
Composer Product Videos	1445

Welcome

Welcome to the Composer 8.1.5 Help. Composer is an **Integrated Development Environment (IDE)**, based on **Eclipse**, for developing:

- **Routing applications** for the Genesys **Orchestration Platform 8.x (ORS)**—which takes the Genesys core capability of routing, extends it, and integrates it tightly with other Genesys products.
- Voice applications for **Genesys Voice Platform (GVP) 8.1+**—a software suite, which unifies voice and web technologies to provide a complete solution for customer self-service or assisted service.

Expand the Table of Contents on the left to view all topics. Use the links below to get started in functional areas.

Tip

You can also click **Search** at the top right. To search all Genesys docs, or just Composer, position the cursor immediately after the magnifying glass and press Enter. A search page appears. Composer is under **On-Premise Content**.

Quick Start

See the **Composer Videos**, specifically the video on Getting Started After Installation.

- Use the information below **Quick Start** to learn how to create a simple routing strategy, attach data that will appear on the agent desktop, and route to the preferred agent.

Videos

Don't miss the **Composer videos**. Since Orchestration Server executes the SCXML-based routing strategies created in Composer, you might also be interested in the **Orchestration Video**.

Introduction to Composer

This section includes the following information:

Validation, Debugging & Deployment

This section includes information on:

[Quick Start](#)
[Introduction to Composer](#)
[Interface Overview](#)

[Samples and Templates](#)

[Validation](#)
[Debugging Routing Applications](#)
[Debugging Voice Applications](#)
[Testing on Tomcat](#)

GVP Voice Applications
This section includes information on:

[Creating Voice Applications](#)
[Sample Text-to-Speech Application](#)
[Preferences for Voice Applications](#)
[How Do Voice Applications Work?](#)

[Voice Block Palette Reference](#)

Sample Applications & Templates
This section includes information on:

[Routing Templates and Samples](#)
[Project Templates](#)
[Diagram Templates](#)
[GVP Voice Project Templates](#)

[Last Called Agent Routing](#)

Orchestration Routing Applications
This section includes information on:

[Creating Routing Applications](#)
[Sample DNIS Routing Application](#)
[Preferences for Routing Applications](#)
[Interaction Process Diagrams](#)

[Routing Block Palette Reference](#)

Installation, Videos, Troubleshooting
This section includes information on:

[Installation Video](#)
[Installation/Deployment Guide](#)
[Troubleshooting](#)
[Best Practices](#)

[Useful Resources](#)

Common Voice & Route Functionality
This section includes information on:

Links to Useful Docs
This section includes information on:

[Code Generation](#)

[Exception Events](#)

[Diagram Preferences](#)

[Defining Variables](#)

[Expression Builder](#)

[Orchestration Server Wiki](#)

[Orchestration Server Extensions](#)

[SCXML Language Reference](#)

[Genesys Voice Platform Wiki](#)

[System-Level Guides](#)

Composer Overview

Use to Create Routing and Voice Applications

Composer is an Integrated Development Environment (IDE), based on Eclipse, for developing:

Routing applications for the Genesys Orchestration Platform 8.x, which includes:

- **Universal Routing Server** (URS)—which enables intelligent distribution of voice and multimedia interactions throughout the enterprise.
- **Orchestration Server** (ORS)—an open standards-based platform with an SCXML engine, which enables the customer service process. ORS is responsible for executing orchestration logic (SCXML) that is provided by an application server (such as an application server hosting an SCXML-based routing application created in Composer). The responsibility of URS within the Orchestration Platform is to provide a necessary service to Orchestration Server to support Routing functions.

Voice applications for **Genesys Voice Platform** (GVP) 8.1+—a software suite, which unifies voice and web technologies to provide a complete solution for customer self-service or assisted service.

Tip

- In the past, **Interaction Routing Designer** was used to create routing applications. Genesys Composer is now the tool of choice for creating both routing and voice self-service applications.
- Previously Composer was known as "Composer Voice," as it was used only to develop voice applications for Genesys Voice Platform. Starting with 8.0.2, the capabilities of the IDE were expanded to include support for Universal Routing application development. Due to this expansion in scope, the product name was shorted to "Composer."
- The terms Composer Voice and Composer Route are used in some places in the product, to refer to the collection of product features that are used specifically for Genesys Voice Platform application development, and Universal Routing Application development, respectively.
- Users may enable/disable Composer Voice and/or Composer Route capabilities through a Composer preference setting (Window > Preferences > General > Capabilities > Advanced). This is useful for developers who are only using one of these Genesys platforms.

Application Development

Composer provides both drag-and-drop graphical development of voice applications (or "callflows")

and routing strategies (or “workflows”) as well as syntax-directed editing of these applications.

- For voice applications for the Genesys Voice Platform, Composer supports editing of VoiceXML 2.1, CCXML1.0 and SRGS 1.0.
- For routing applications for the Genesys Orchestration Platform, Composer supports editing of SCXML 1.0. Applications may be developed in an “offline” mode, without requiring the user to connect to Genesys Configuration Server.

Application Debugging

Composer provides real-time debugging capabilities for both voice and routing applications.

- The [Genesys Voice Platform Debugger](#) is integrated with [GVP](#) for making test calls, viewing call traces, and debugging applications. It supports accessing SOAP and REST-based Web Services. Database access is possible using server-side logic and a Web Services interface.
- The [Orchestration Server Debugger](#), integrated within the workflow editor, works with both live and simulated calls. For live calls, it places those calls into a T-Server/SIP Server connected to a URS/ORS system. The capabilities include setting breakpoints, stepping through a workflow, viewing and setting the values of variables, and viewing event messages from the URS/ORS platform.

Eclipse

Composer is an [Eclipse](#)-based application. The use of Eclipse as the underlying framework enables the use of third party IDE plug-ins, supporting integration with third party source code control systems, server-side development enhancements, and side-by-side development of any business logic required to support your applications.

Operating Systems

For information on supported operating systems, see the [Genesys Supported Operating Environment Reference Guide](#).

Composer Help Wiki URL

The URL to the Composer Help wiki is configurable by using the Online Wiki URL field: **Window > Preferences > Help**. The default works with English but if, for example, Japanese pages were available in a different location, then you could change the URL accordingly.

Third Party Software

For information on the third party software used in Composer, see the [Legal Notices under More Release Information](#) at the bottom of the Composer main page.

Getting Help

- Use the Search This Manual (or Product) box at the top right. You can search by product, book type, version, and book type.
- Create a searchable PDF. Scroll down to PDF version at the bottom left of a page.
- Use the TOC on the left of each page to locate information.
- Depending on your location in the user interface, Composer's context sensitive help triggers wiki pages.
- Press F1 to get help on a page. A Help view opens on the right.

Block Palette Reference

For information on Composer blocks and block properties, you can go directly to the following:

- **Voice Block Palette Reference** (when building applications for Genesys Voice Platform (GVP))
- **Interaction Process Diagram Block Palette Reference** (used for multimedia/routing applications to define how interactions move through various processing objects)
- **Routing Block Palette Reference** (when building routing applications for the Orchestration Platform)
- **Common Blocks Block Palette Reference** (blocks used for both voice and routing applications)

Composer Installation Video

Video Tutorial

Below is a video tutorial on installing Composer 8.1.4 on Windows in an [Eclipse](#) environment.

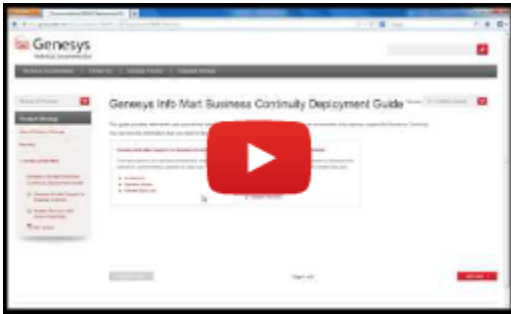

For additional installation information, see [Installation](#) in the *Composer 8.1.4 Deployment Guide*.

Composer Quick Start

Tip

See Getting Started After Installation the [Composer Videos](#).

The information below is intended to be a Quick Start for routing strategy development with Genesys Composer. A routing strategy is comprised of one or more routing workflows. Regardless of the version of Composer you have installed, this Quick Start (which reflects the Composer 8.1.2 interface) will help you get started using Composer.

The goal of this Quick Start is to:

1. Create a simple routing strategy workflow that will distribute an inbound call to an agent.
2. Add attached data to this workflow that will be popped when the call is delivered to the agent desktop.
3. Route the call to a preferred agent and if the agent is not available then expand the agent pool.

The steps below assume you have already installed a Genesys environment and have configured an Orchestration Solution, which includes [Workspace Desktop Edition](#), [Interaction Server](#), [Composer](#), and [Orchestration Server](#).

Creating a Sample Workflow

1. In [Workspace Desktop Edition](#) (or "Interaction Workspace"), log in and make agents Ready). This example uses 04 Agent KSippo, and 05 Agent KMilburn. Also make Ready the customer phone. This example uses the Pat Thompson customer phone.
2. Click the Eclipse icon on your desktop to open Genesys Composer.
3. Ensure that Genesys Composer is connected to [Configuration Server](#). The current status of the connection to Configuration Server is displayed in the lower right of Composer.

Tip

When you set up your Configuration Database (Configuration Server), you define certain database objects, such as agents (Persons), Agent Groups, Skills, and so on. These objects can be defined in [Configuration Manager](#) or in [Genesys Administrator](#). When you use Composer to create SCXML-based routing strategies executed by [Orchestration Server](#) (and Universal Routing Server), there is a button to [connect to Configuration Server](#). When creating a routing workflow in Composer, those Configuration Database objects will be available in the Composer workflow building blocks that use them. For example, you might be creating a workflow that routes to an Agent Group and using Composer's Target block. The Agent Group you defined in the Configuration Database would be available for selection in the Target block.

4. If Composer indicates Disconnected from Configuration Server, then select **Configuration Server**

from the **main toolbar** and click **Connect**.

5. Enter the appropriate connection information and click **Next**.

6. Select the tenant, such as **Environment**, or the name of another tenant (business entity).
7. Within Composer, create a new Project: **File > New > Java Composer Project**.
8. Give the Project a name, for example, MySample.
9. Ensure that **Integrated Voice and Route** is selected.
10. Click **Finish**.
11. Go to the new Project folder that you was just created (MySample) and open the Main workflow and default workflow.
Upon selecting the default.workflow a blank workflow palette will appear.
12. Within the .workflow, drag and drop an Entry block, Target block, and Exit block from the palette of blocks onto the workspace. Make sure you are working within .workflow and not the .callflow (used for GVP voice self-service applications).
13. Go to the Target block and select the Targets property. This is done by selecting: **Target > Properties > Target Selection > Targets** on the far right. Upon selecting the Targets property, a new Targets box will appear:
14. Within the Target block, select **Add** and enter the following:
 - **Type:** Agent Group
 - **Name:** SIP Group
 - **Stat Server:** Stat_Server

Tip

If you are connected to Configuration Server, you are able to directly pull information from Configuration Server to populate the options. You are not required to be connected to Configuration Server to perform development as Composer allows you to perform development offline and then connect and validate against Configuration Server at a later time.

15. In the Target block set the Timeout property to 99.
16. Click the **main toolbar** buttons to validate your workflow and then generate the code.

Tip

To validate the workflow and generate the code, the focus must be within the palette where the workflow is being designed. To validate you can enter Alt+V. Or you can validate by right clicking the `default.workflow` from the Project Explorer window and selecting **Validate** from the main toolbar. Code can be generated by entering Alt+G or clicking on the **Generate** button on the **main toolbar**.

17. Go to the Interaction Processes folder in the left Project Explorer. Right-click on the interaction process diagram file (`default.ixnprocess`) and perform a similar process to validate and generate the code validate the default interaction process diagram.
18. Right-click on the interaction process diagram file (`default.ixnprocess`) and select **Publish** to Configuration Server. You should receive a message that the interaction process diagram was validated and published to Configuration Server.

Tip

An SCXML-based workflow is first invoked by the interaction process diagram. If you open the interaction process folder, you will see that there is a workflow named `defaultworkflow`. This workflow in turn points to the actual workflow that you just created, which is in the Location/Resource property of the Workflow block. If you change the name or have multiple workflows, you need to ensure that the appropriate association is maintained.

19. Assuming this routing strategy only contains one workflow, you are now ready to "provision" the new workflow. Within **Genesys Administrator**, provision a new DN on the SIP_Switch

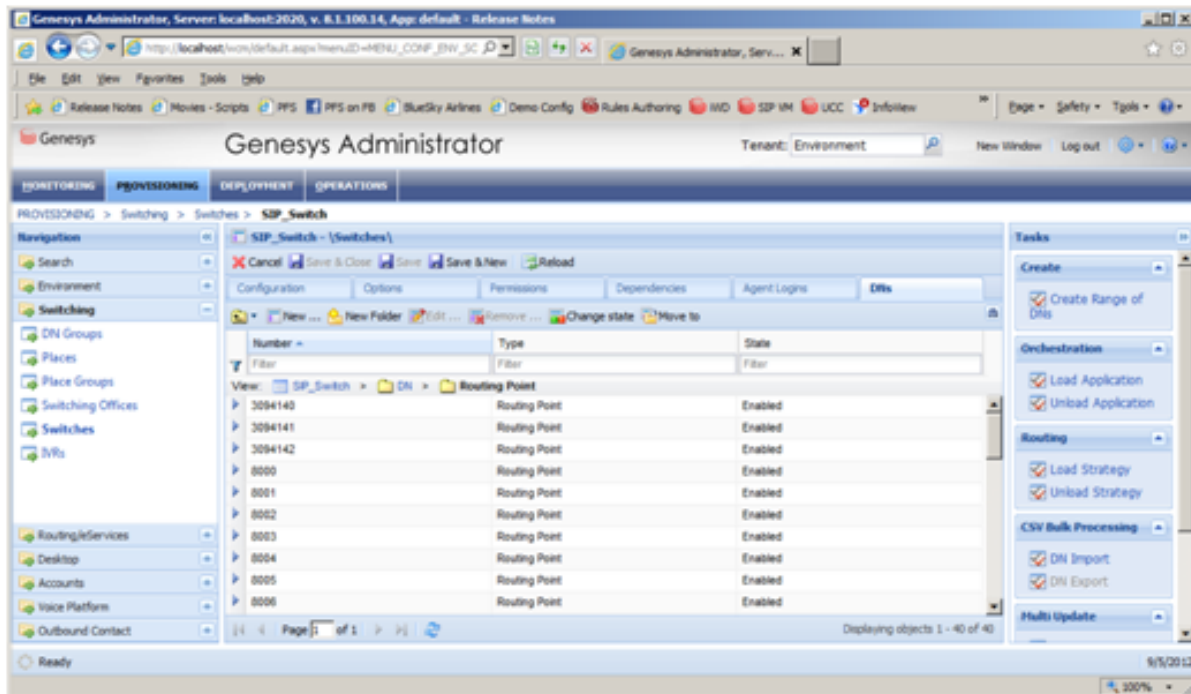

Example: Number: 4000 Type: Routing Point

20. Under **Routing** > **Orchestration** (see below), select the workflow that was just created: MySample.default.defaultWorkflow.

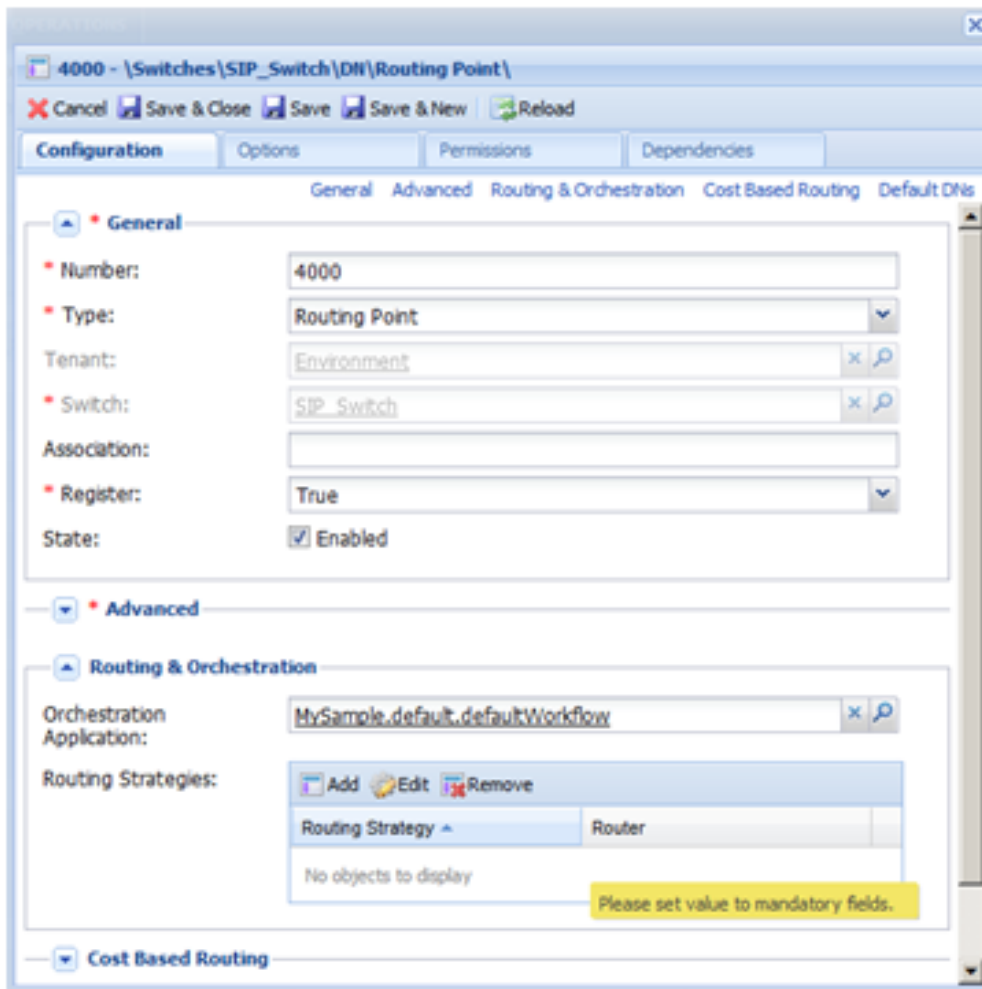

21. Confirm that your routing strategy works:

- Make your agents Not Ready.
- Place a call from the customer phone to 4000. Note: We do not yet have a treatment so the caller will not hear any initial treatment.
- Make KSippola Ready.
- Confirm that the call is delivered to the available agent and they receive a screen pop.

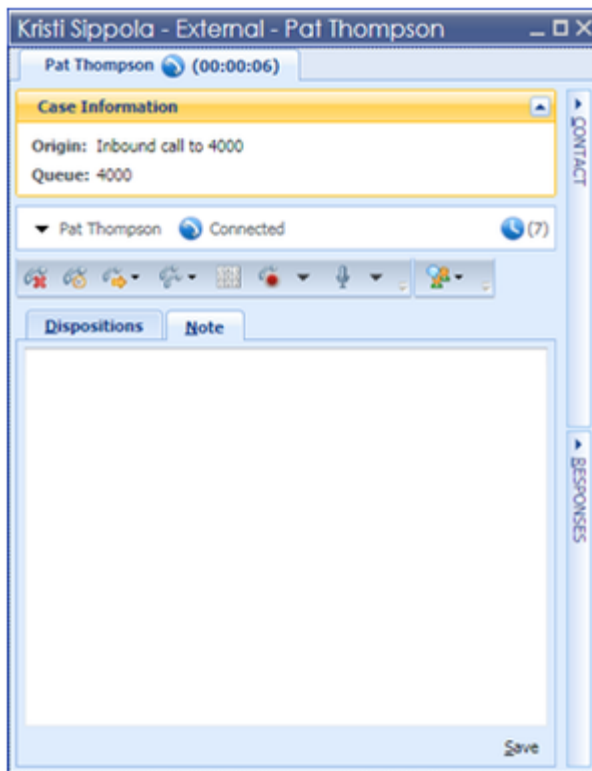

Add a Treatment

Add a simple queue treatment that the caller will hear while waiting for an available agent.

1. Utilizing the existing workflow, select the Target block. In the properties under Route Target, set Use Treatments to true.
2. Add a Play Sound block from the Voice Treatment icons palette. Connect the Busy Treatments from the Target block to the Play Sound block. Connect the output from the Play Sound block to look back to the Target block.

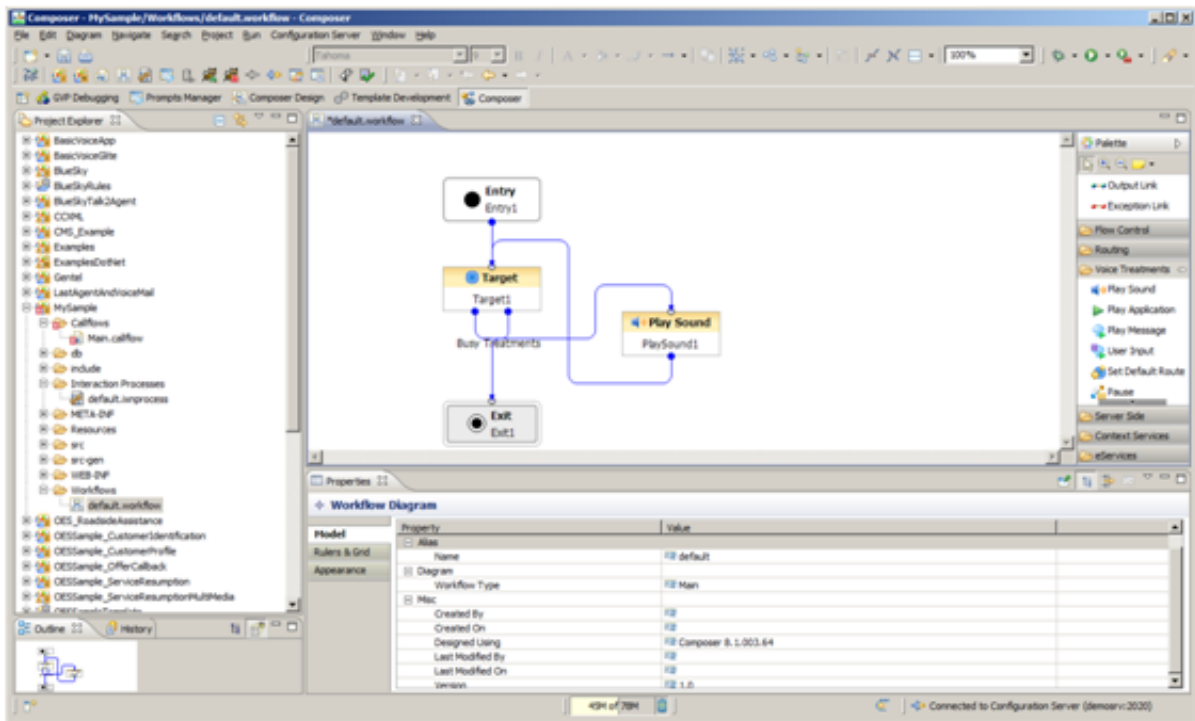

3. Within the Play Sound block set the Resource property to play back the badon_hold.wav file, which is already present on the Demo Server.
4. Proceed to [validate the code](#), [generate the code](#), and then place a call back into to your Routing Point with all agents in a Not Ready state. Confirm that queue music is received by the caller.

Attaching Data

Add attached data to this strategy that will be popped when the call is delivered to the agent desktop. In this example you will need to add your name as a value for one of the appropriate keys and ensure that it is popped to the Interaction Workspace desktop.

1. Utilizing the existing workflow that was just created add a User Data block from the palette in between the Entry and Target blocks.

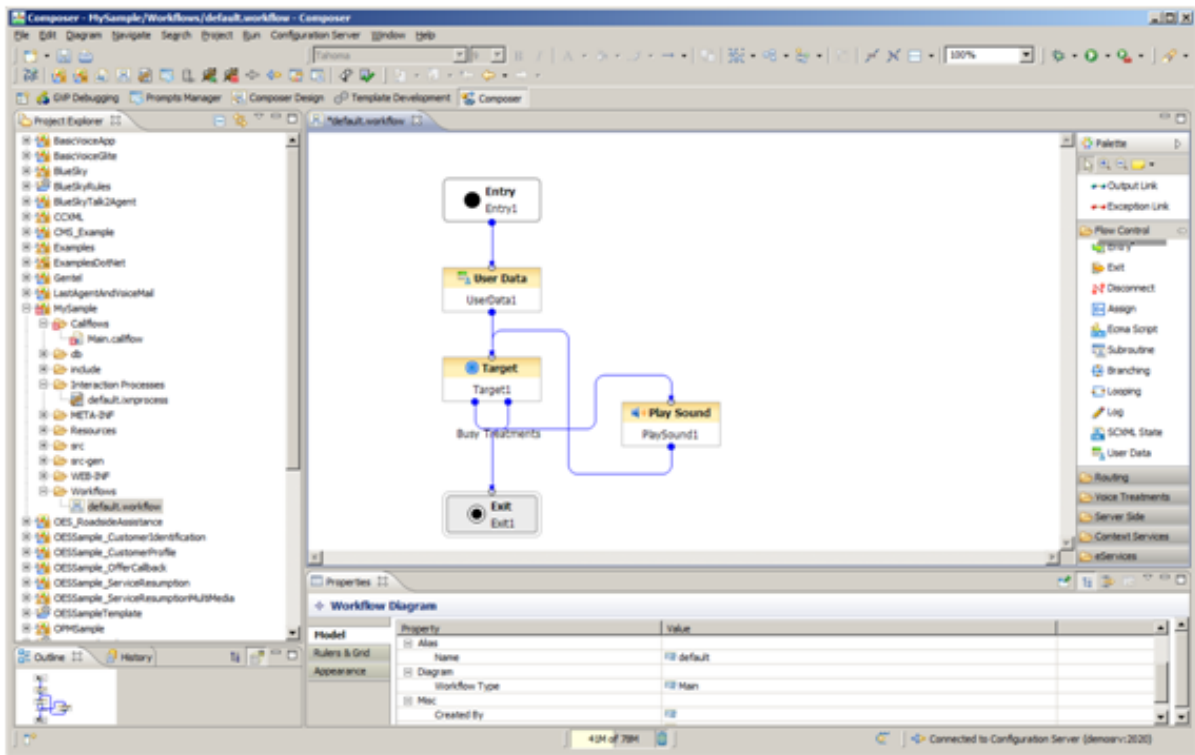

- In the Assign property of the User Data block configure an appropriate key and value where the value is your name; for example, Don Huovinen.

The 'Assign Data' dialog box is shown with the following configuration:

- Key:** Literal (dropdown), NewKVP (text field)
- Value:** Literal (dropdown), Don Huovinen (text field)
- Value is numeric:**

While we are attaching data using this block you must also ensure that the new key; NewKVP in the example shown above, will appear properly in Interaction Workspace.

- Validate your workflow and then generate the code.
- Modify the settings of Interaction Workspace to display the key-value pair, which we just added, in our case the key is "NewKVP" and we want this displayed in Workspace as "My Complete Name". Within Interaction Workspace, the key-value pairs that will be displayed are based on the keys that

are listed in the CaseData **Business Attribute** so we need to add "NewKVP" as one of the values in the CaseData business attribute for this KVP to be properly displayed in Interaction Workspace. This can be done by searching for the Case Data business attribute.

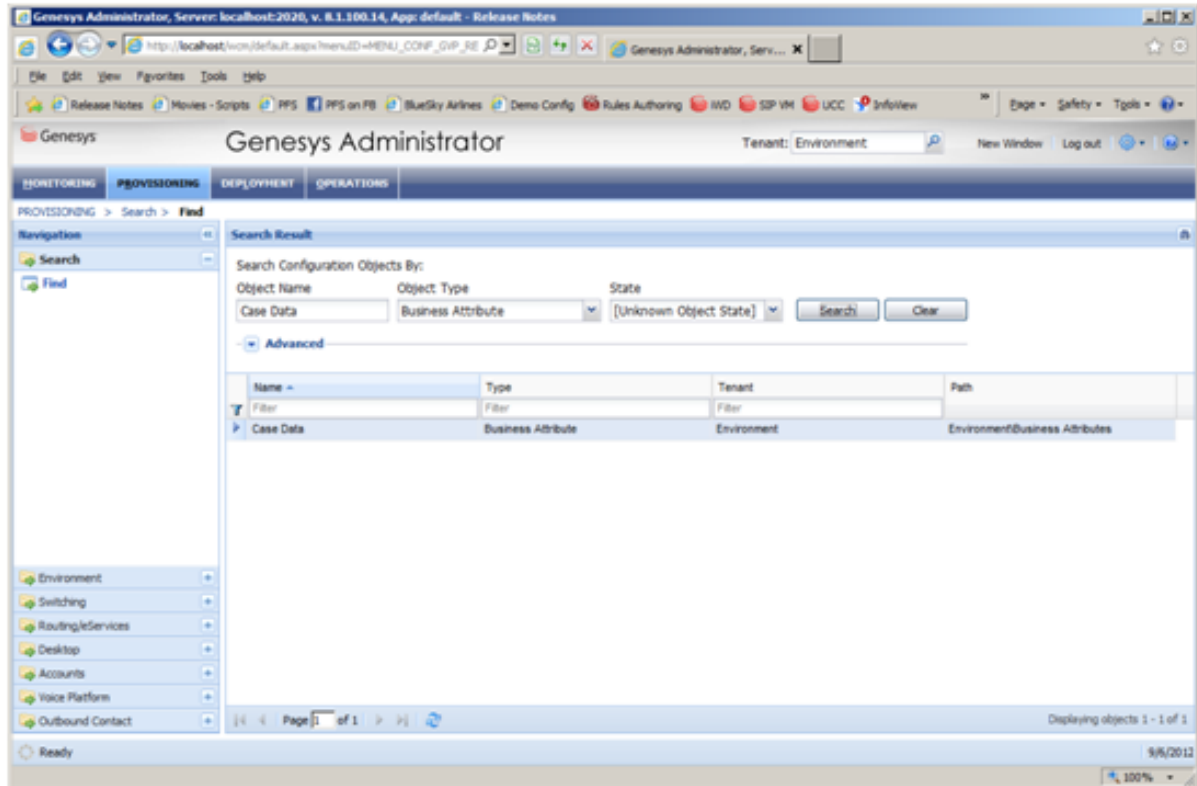

5. Then double-click on Case Data, select the **Attribute Values** tab, and then select to **Add** a new attribute. The **Name** will be the name of the key (NewKVP) and the **Display Name** is the name we want displayed in Interaction Workspace.

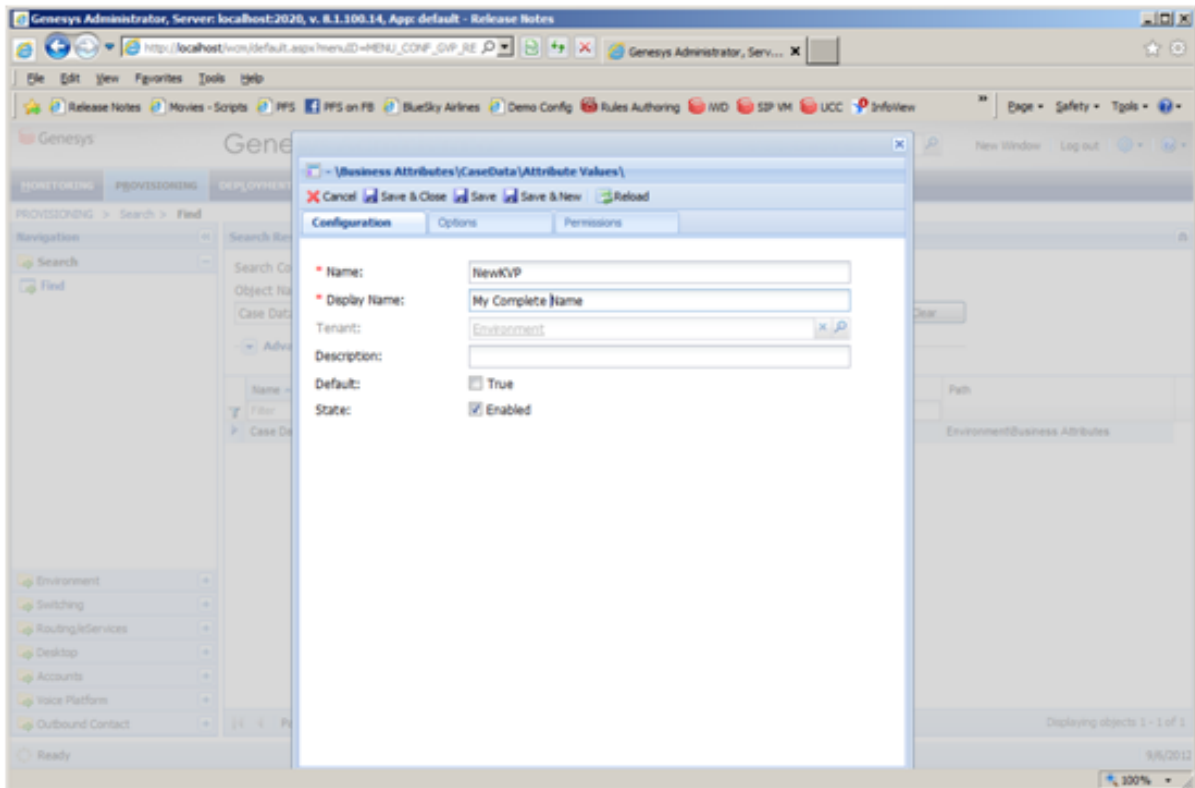

6. Make your agents Not Ready.
7. Place a call from the customer phone to 4000. The caller should hear music.
8. Make the agent Ready.
9. Confirm that the call is delivered to the available agent and they receive a screen pop.

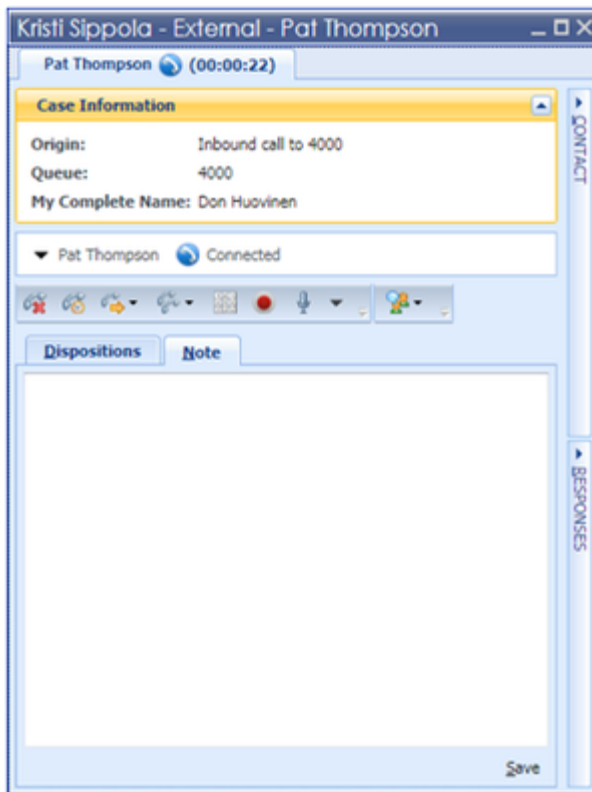

Routing to a Preferred Agent (Add Flexibility)

Provide routing to a preferred (last handling) agent and if that agent is not available within the defined threshold expand the pool of available agents so that the call can be successfully delivered.

1. Using the existing routing workflow, add a new Target block from the palette in between the UserData block and existing Target blocks.
2. Within the new Target block label it "Personal_Agent" and set the Target block to target KSippola.
 - **Type:** Agent
 - **Name:** KSippola
 - **StatServer:** Stat_Server

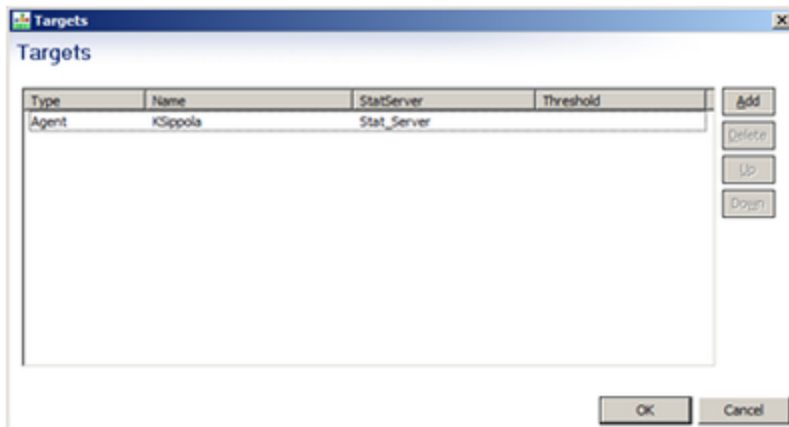

3. Set the Timeout property of the block to 15.

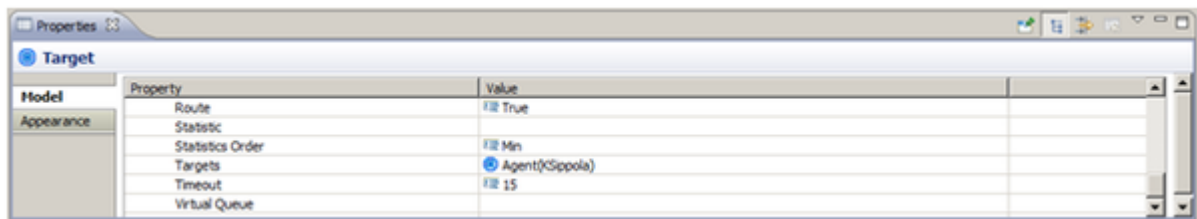

4. Set the Exceptions property to capture an exception of `error.queue.submit`
5. Within the workspace, connect the `error.queue.submit` exception from the new Target block you just added to the previous SIP group target block that you already have. Connect the normal outlink from this new Target block to the existing Exit block. A example flow is provided below.

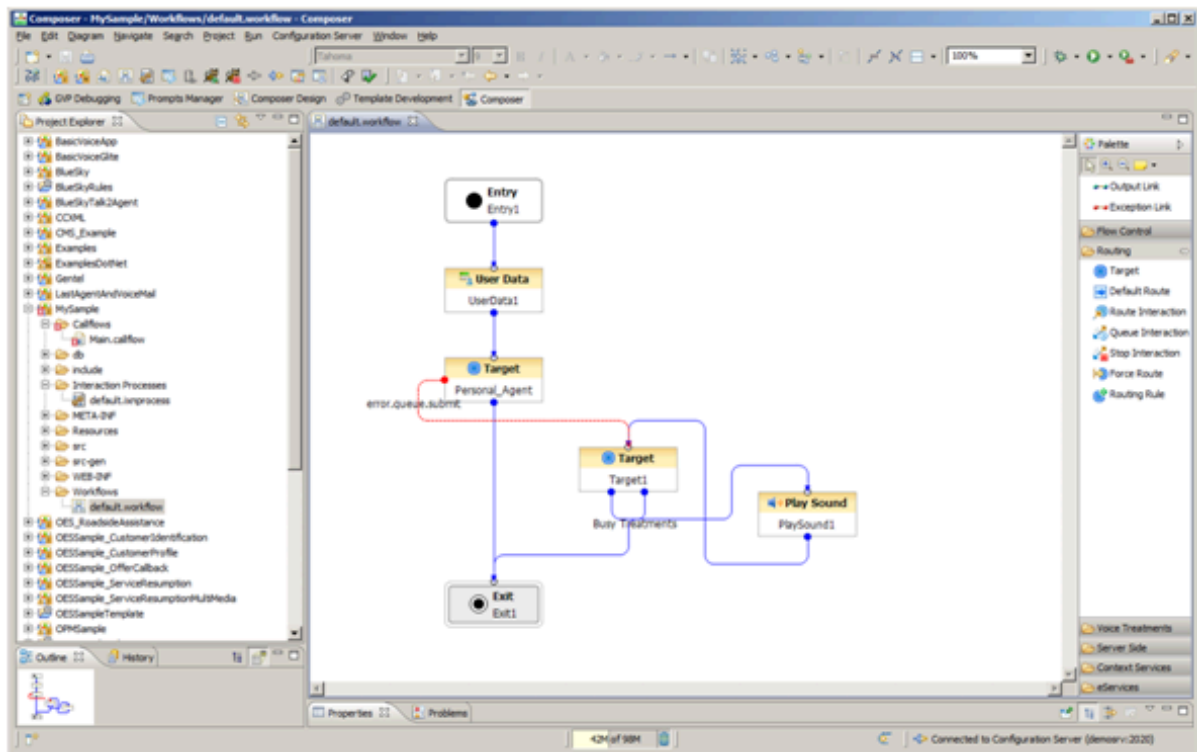

6. Validate your workflow and then generate the code.
7. Test that your routing and logic works as desired:
8. Make KSippola and KMilburn ready.
9. Place a call from the customer phone to 4000.
10. Confirm that the call is delivered to KSippola and he receives a screen pop.
11. Make KSippola NotReady
12. Place a call from the customer phone to 4000.
13. Confirm that the caller waits and after the timeout the set of targeted agents has been expanded the call is delivered to KMilburn. Note: The prior example is a scenario that shows target expansion, but can be improved if another different treatment is provided while the caller is waiting for their personal agent. As the target expansion occurs, you could also change the treatment to provide an audible queue position. An example is callflow is shown below.

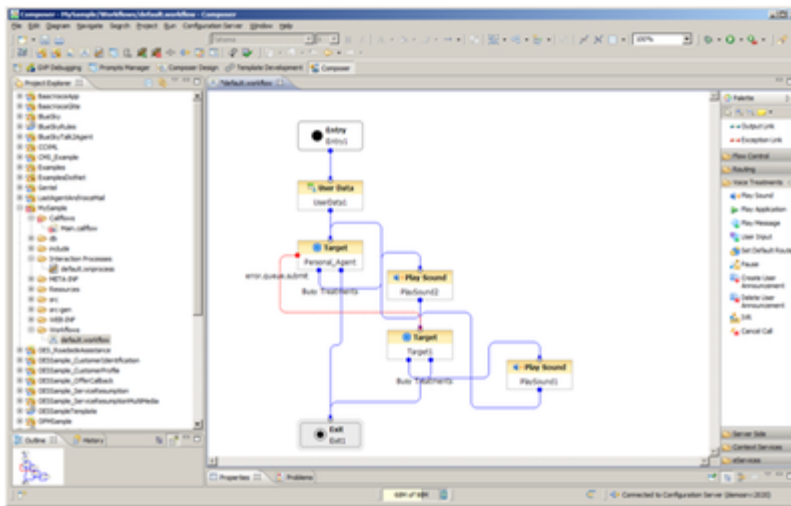

14. Validate your workflow, Generate the code and then proceed to place a call to show the new scenario:
15. Make KSippola Not Ready and KMilburn Ready.
16. Place a call from the customer phone to 4000.
17. Confirm that the caller waits and after the timeout the set of targeted agents has been expanded the call is delivered to KMilburn.

Summary of Example Workflow

- This example workflow strategy could represent a "last agent routing" approach or preferred/ personal agent routing. If the preferred destination is not available, you could expand the target list so that you have 1) optimal routing and 2) do so within the context of desired service levels. As the target group is expanded, you not just moving from A to B when expanded. The workflow is now looking at the A + B. You could alternatively just overflow to B if desired through the Target Selection properly (Clear Targets = True).
- You could also place a subsequent call, wait until the timeout and then make KSippola available showing that KSippola is still part of the target group and will receive the call. Technically KSippola is a subset of SIP agents therefore you really don't have the A+B as described previously as A is a member of B but the A+B target expansion discussed previously is still valid.
- When attaching User Data. you can utilize any key name you want. However. you need to make the necessary changes in **Interaction Workspace** to display the desired attached data. The workspace will utilize attached data present in the call such as the caller ID to look up information from Universal Contact Server and use the information obtained from UCS for the screen pop in Contact area.
- Interaction Workspace may take a long time to start. This is because the Interaction Workspace agents are configured for a number of interaction channels such as e-mail, SMS, chat, and so on. Therefore, when Workspace starts, it attempts to connect to Interaction Server. If Interaction Server is unavailable, then each channel will be attempted sequentially and need to time out before proceeding to the subsequent channel.

Eclipse Workbench

- As described in the *Composer Deployment Guide*, Composer 8.1.4 is installed as an Eclipse plugin.

Since Composer is based on based on **Eclipse**, you may wish to familiarize yourself with basic Eclipse concepts by referring to the *Workbench User Guide* although this is not mandatory. The *Workbench User Guide* presents an overview of many of the same concepts used within Composer, but from the Eclipse development environment framework perspective. Reviewing this information can be valuable as a first step in getting familiar with the Eclipse user interface on which Composer is based. To access the *Workbench User Guide* online help:

1. Select **Help > Help Contents**. The system displays the Help - Composer window.
2. In the Contents navigation pane, click **Workbench User Guide**.
3. Click **Concepts** in the main Help pane.

Review the multiple sections of the Concepts section to gain familiarity with Eclipse.

- Select Search from the main Help menu to search the Eclipse Help.

Introduction to Composer

Composer is an Integrated Development Environment (IDE) based on [Eclipse](#) for building voice applications for the Genesys Voice Platform (GVP) 8.1+ and routing applications for the Orchestration Server 8.0+.

What is Composer?

Composer is the next generation version of Genesys Studio based on Eclipse 3.5.1. It provides a rich development experience, which Web Application developers are already used to, for building VoiceXML, CCXML, and SCXML applications. Familiarize yourself with basic Eclipse concepts by referring to the *Workbench User Guide* (**Help > Help Contents**). Composer provides ability to develop the following types of applications.

For the GVP 8.x NGI Interpreter:

- [Pure VoiceXML Applications](#) with full support for Genesys extensions
- CCXML + VXML Applications requiring advanced call control features including Conferencing
- CTI + VXML Applications for Genesys Framework

For the [Orchestration Server](#) 8.x SCXML Engine/Interpreter:

- [Pure SCXML Applications](#) with full support for all Genesys [predefined SCXML functional modules and extensions](#) used for creating SCXML-based strategies and routing applications.
- Voice Routing SCXML applications for handling media of type voice for Inbound channels.
- Integrated CTI + VoiceXML applications for end-to-end treatment handling in conjunction with GVP and Stream Manager.

GUI Designer

Composer provides a drag-and-drop based [interface](#) for creating VXML and SCXML applications. Users can easily create flow diagrams by placing and connecting blocks and configuring properties. This approach also provides an easy mechanism for invoking Web Services and doing database lookups from the Application server-side. Custom blocks can be created that can be added to the supplied palette of blocks.

Code Editors

For those who prefer to write their own code, Composer provides a set of rich [editors](#) for SCXML, VXML, CCXML, and GRXML along with use case templates.

Templates

Out-of-the-box, reusable **template** applications are provided. These can act as a starting point for new projects and visual flows and serve as guidelines and tutorials for routing and voice application developers. Composer also provides templates for its rich editors with the ability to create user-defined custom code snippet templates, which can be exported and imported to share across team members.

Code Generation

When **generating code**, Composer provides the ability to generate Static VXML pages to take advantage of the Platform optimizations. For SCXML routing strategies, Composer provides the ability to generate Static SCXML pages for improved performance due to caching.

Debugging

Debugging functionality includes the ability to debug VoiceXML applications and callflow diagrams with the **GVP Debugger** and **GVP Debugging perspective**. The real-time GVP Debugger supports both Run and Debug modes. In the Run mode, **call traces** are provided and the application continues without any breakpoints. In the **Debug mode**, you can input breakpoints, single-step through the code, inspect variable and property values, and execute any ECMAScript from the query console. Composer provides real-time debugging capabilities for SCXML-based Orchestration Server (ORS) applications. The ORS Debugger is integrated within the workflow **designer** for making test calls, creating breakpoints, viewing call traces, stepping through an SCXML document/workflow, and debugging applications. Debugging can be started on an existing session or it can wait for the next session that runs the application at a given URL.

Deployment

Composer provides the ability to **deploy applications**. Future releases will provide the ability to deploy routing applications.

Project Management

Composer provides full project management capabilities for managing all the resources in a Composer project.

Routing Strategies

Composer is integrated with Genesys Configuration Server, which provides the ability to define and fetch strategy-related data residing in the Configuration Server database. This integration allows developers to find and select routing targets when using Composer's Target block. When creating routing strategies, developers can define List objects and routing-related Statistics.

Software Prerequisites

Consult the following:

- [Installation](#) topic in the *Composer 8.1.4 Deployment Guide*.
- The Composer section in the [Genesys Supported Operating Environment Reference Guide](#).

Interface Overview

Note: The minimum screen resolution for Composer is 1024x768 on a standard 4:3 aspect ratio monitor. The recommended resolution is 1280x1024. Lesser resolutions, such as 800x600, are not supported.

Introduction to the Interface

Below is a short video introducing the Composer interface.

[Link to video](#)

Sample Applications

For a sample voice applications, see [Hello World Sample](#), which describes a text-to-speech application. For a sample routing applications, see [Your First Application](#), which describes a DNIS routing application.

Blocks, Connectors, and Properties

The Composer interface uses workflow and callflow design components (*blocks* and *connectors*) to create voice and routing applications

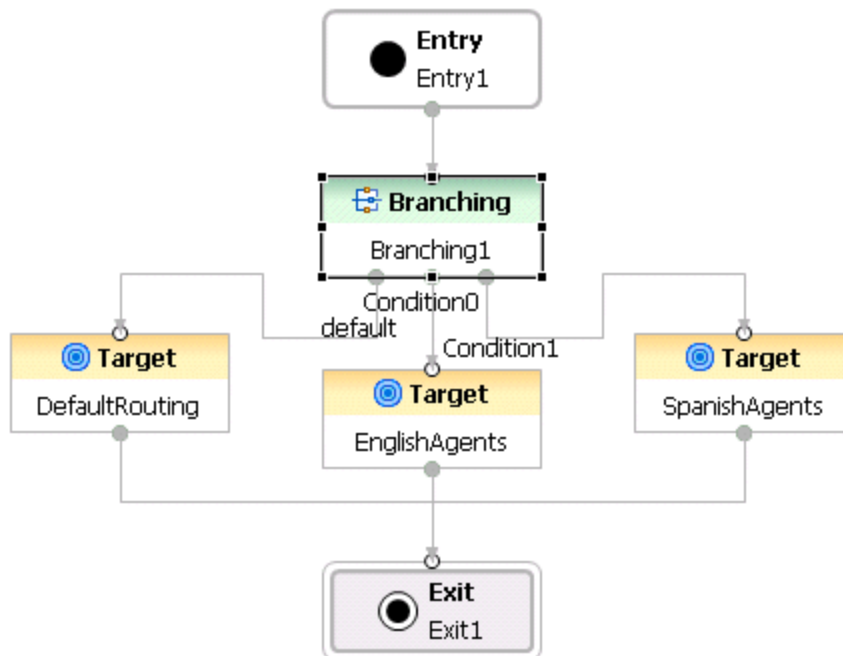

It uses drag-and-drop to arrange, add, and delete blocks on a design area. The blocks are connected within the design area to build the flow for the application. You define the properties for a selected block in Composer's *Properties* view. Also see: [Working With Diagram Layouts](#)

Interface Elements

The first time you enter the Composer perspective, since your workspace is empty and does not contain any Projects, you will see an empty Project Explorer on your top-left, and a blank center area. After you create a **voice** or **routing** Project, the **Project Explorer** shows all the files and resources that make up the Project. The figure below shows the GUI elements in **Composer perspective** for a sample routing application.

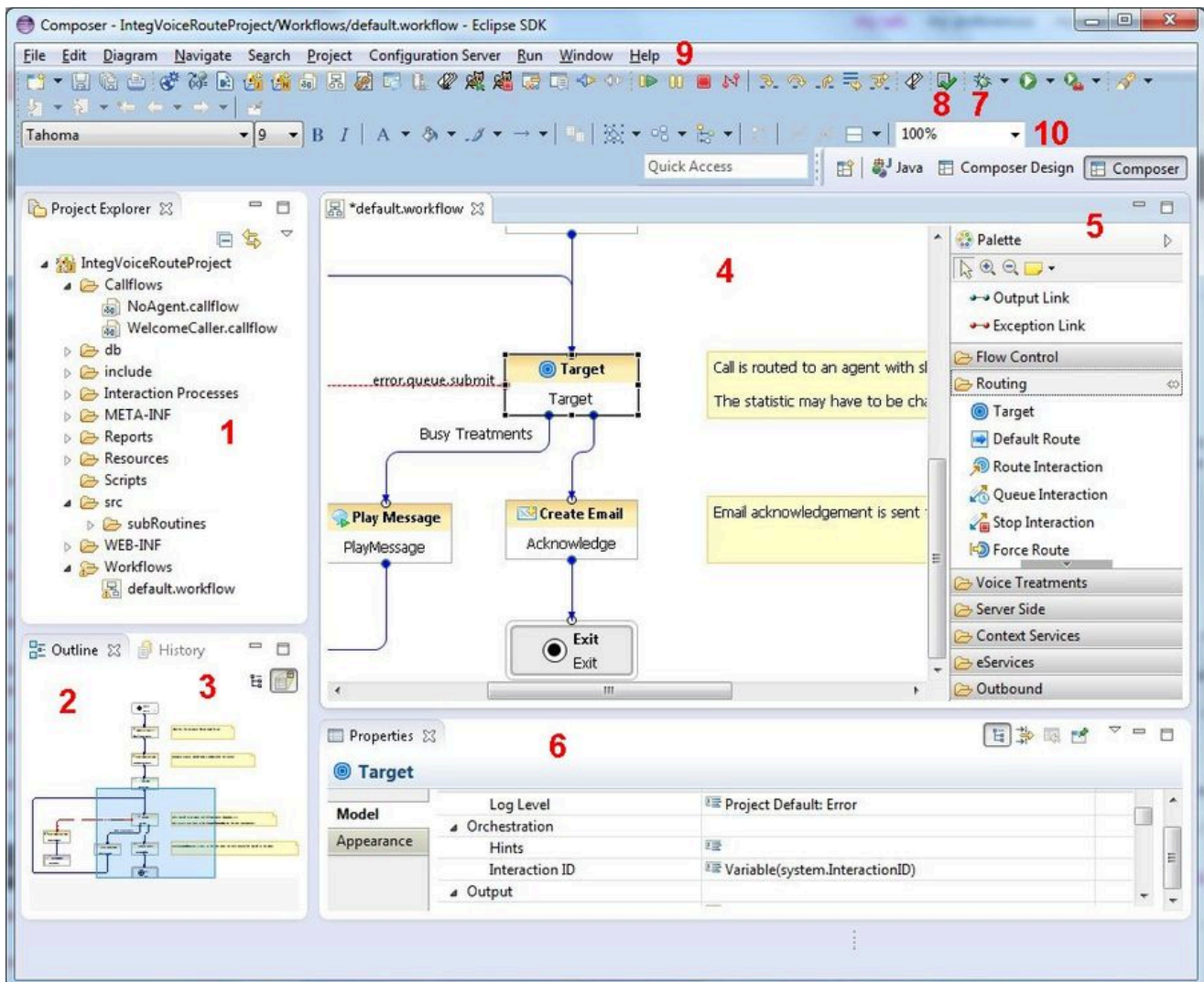

GUI Element Descriptions

The numbers in the figure above are keyed to the table below.

1	The Project Explorer shows all the files and resources that make up a Project. See Composer Projects and Directories for more information.
2	For large flows, the Outline view (shown above) allows you to navigate to the portion of the flow to view in the design area.
3	The History view maintains previous versions of flows and application files, allowing you to revert to any previous version if needed.

4	The design area is where you create flows by placing and connecting blocks. Composer's design area is the work area that you will use for building your applications.
5	The Palette contains workflow diagram-building blocks or callflow diagram-building blocks grouped in various categories: Voice Block Palette Reference and Routing Block Palette Reference .
6	The Properties view shows block properties and allows you to modify settings, set variables, and otherwise change or set the properties corresponding to a block. This area also displays Call Traces during debugging, or Problems during validation or testing.
7,8	In the top toolbar, the Validate button allows you to check for syntax errors. The Generate Code button creates VXML and SCXML pages from the diagrams you create.
9	Menus and Toolbars provide commands and operations for running Composer.
10	Perspective buttons show the active perspective and let you easily move between perspectives. By default, when you enter the workbench for the first time, you will be taken inside the Composer perspective. Perspectives are arrangements of different sections of the GUI in a manner that facilitates easy use of a particular feature. For example, the GVP and ORS Debugging perspectives will show those sections (Breakpoints, Call Trace, Variables, and so on) that are useful when debugging an application.

Composer displays a Help view on the right if you select **Help > Search** or **Help > Dynamic Help**.

Perspectives

When you select **Window > Perspective > Open Perspective > Other**, all perspectives available in Eclipse are listed, including those not used by Composer.

Use the following Composer [perspectives](#) for building applications:

- [GVP Debugger](#), for debugging applications you build or import
- [ORS Debugger](#), for debugging routing applications you build or import
- [Prompts Manager perspective](#), which provides the ability to quickly review all prompts in a Composer Project
- The [Composer perspective](#) shows the Project Explorer, Outline view, design area, and Palette of blocks. Composer perspective can show the following tabs in the lower pane: Properties, Prompts Manager, Problems, Console, and Call Trace. Select **Window > Open Perspective**.

- Composer Design perspective can be used to show only the palette of blocks, the canvas area, and the Properties tab.

Any customized perspective appears in this list. You can configure perspectives on the **Window > Preferences > General > Perspectives** preference page.

Customizing the Show View Menu

A **view** can be displayed by selecting it from the **Window > Show View** menu. You can customize this menu by using **Window > Customize Perspective**. Click the **Submenus** down arrow and select **Show View**.

Using the Interface

Blocks

A **block** is the basic building unit that you use to create applications. In Composer perspective, the palette of blocks is located in the right-most part of the main window (unless the Help window is also visible) and contains various categories of blocks. Every application must start with an **voice Entry block** or **routing Entry block**. You can also create **Custom Blocks**. A routing applications starts with **Interaction Process Diagram Blocks**.

Using Blocks

When creating voice application callflows and routing application workflows using the designer:

- You double-click or drag-and-drop **callflow blocks** and/or **workflow blocks** to place them onto the center area (canvas).
- You configure properties for each block.
- You connect the blocks together by drawing **connection links** to define the flow.

Block Names and Multi-Byte Characters

Composer block names can contain only alphanumeric characters. If multiple-byte characters are used in block names, the code generation step fails and no SCXML or VXML file is generated from the Composer diagram.

Methods for Adding Blocks

There are a few ways to add blocks from the Palette to the canvas. The most common methods are as follows:

- Click on the block icon on the palette, release the mouse and click on the target location on the canvas area.
- Double-click a block icon on the palette.
- Click on the block icon on the palette, and while holding down the mouse button, drag and drop the block to the canvas.

Any of these methods will add the new block and you can then type the name of the block on the canvas itself. Click [here](#) to read about block naming restrictions.

Outline View

For large call or workflows, the **Outline view** allows you to navigate to a portion of the flow diagram to view in the main canvas. It can also be used to facilitate navigation for other types of elements that might appear in the canvas or editor window, such as a large VXML file displayed in the VXML Editor. For more information, see the Outline View topic in the *Eclipse Workbench User Guide* (**Help > Help Contents**).

Simulation View

Simulation view shows the VoiceXML or SCXML code (read only) for a selected block (**IPD** blocks do not have this view). To add the Simulation view to the current perspective:

- Click **Window > Show View > Other > Composer > Simulation**.

Block Context Menus

Or, you can use a block's context menu as follows:

- Select a block in the canvas, then right-click the box and select **Simulate Code** from the context menu as shown in the figure below. The **Simulation** view displays the code for the selected block.

The **History** view maintains previous versions of call and workflows and application files, allowing you to revert to any previous version if needed.



- For more information, see the Local History topic in the *Eclipse Workbench User Guide* (**Help > Help Contents**).

The **Problems view** is used during validation of callflows, workflows, and files (VXML, SCXML, GRXML, and so on). It displays information about errors encountered when validating an application.

- For more information, see the Problems View topic in the *Eclipse Workbench User Guide* (**Help > Help Contents**).

Connection Links

Blocks are connected to each other using connection links. There are two types of connection links:

1. Use **OutLinks** to connect one block's output port to another block's input port:  OutLink
2. Use **Exception Links** to indicate error or **exception** conditions by connecting from a block's exception port to another block's input port:  ExceptionLink

Find the connection links at the top of the palette on the right side of the **Composer window**.

Example

The figure below shows examples of using the link tools:

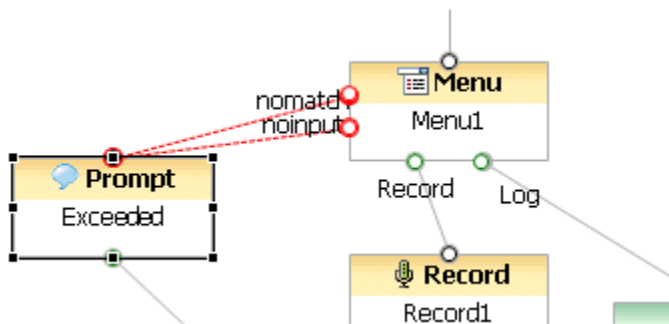

In the above example, the red links (going from the Menu block to the Prompt block) result from using the Exception Link tool to connect the two blocks. The black links (going from the Menu block to the Record block and the Log link) result from using the Outlink tool.

Adding a Link

To add a new Output Link (or Exception Link):

1. Click the Output Link (or Exception Link) icon in the palette.
2. Move the mouse over to the source block. The cursor will change to an upward arrow.
3. Click once on the source block and keep the mouse button pressed. Then drag the mouse onto the target block and release the mouse button.

This will add the connection link between the two blocks. To use an Exception Link, the source block must have an exception port defined. This is done by selecting at least one supported exception

within the block's Exceptions property. Another method for adding an Output Link or Exception Link between two blocks is as follows:

1. Click once on the source block to select it.
2. Hold the Ctrl key and click once on the target block to select it as well.
3. Double-click the Output Link (or Exception Link) icon in the palette to create a connection between the two blocks.

Again, to use an Exception Link, the source block must have an exception port defined.

Changing Style and Appearance

Composer allows you to change the style and appearance of your connection links to suit your needs. To change connection link appearance:

1. Select the connection link(s) you wish to change on the diagram (Ctrl-click to select multiple links). If the Properties view for the selected link is not visible, select **Window > Show View > Properties**. Or right-click the link and select **Show Properties View** from the shortcut menu.
2. In the Properties view, click the **Appearance** button to the left. A palette of appearance options is displayed in the Properties view.

You may change any of the following:

- Font, Font Size, Font Style, and Color
- Line and Arrow Style
- Smoothness of the connection line (None, Normal, Less, or More)
- Routing Style (Oblique, Rectilinear [default], or Tree), as well as the option to avoid obstructions or choose the closest distance for the link (even if it must cross over another block)
- Jump links set how links will be displayed when a link needs to jump over or cross another link (None, All, Below, Above), and the shape of the link crossing over can be Semi-Circle, Square, or Chamfered
- Reverse jump links switches the orientation of the semi-circle, square, or chamfered shape of a crossing link

Composer Code Editors

File > New > <file_type>

Composer provides the ability to hand-code SCXML, VoiceXML, CCXML, GRXML, JSP, and ASP.NET for custom scripts as a part of the application development process. The editors have standard editing capabilities and time-saving features such as a code snippet library, validation checks for errors (during design and save time), and syntax highlighting.

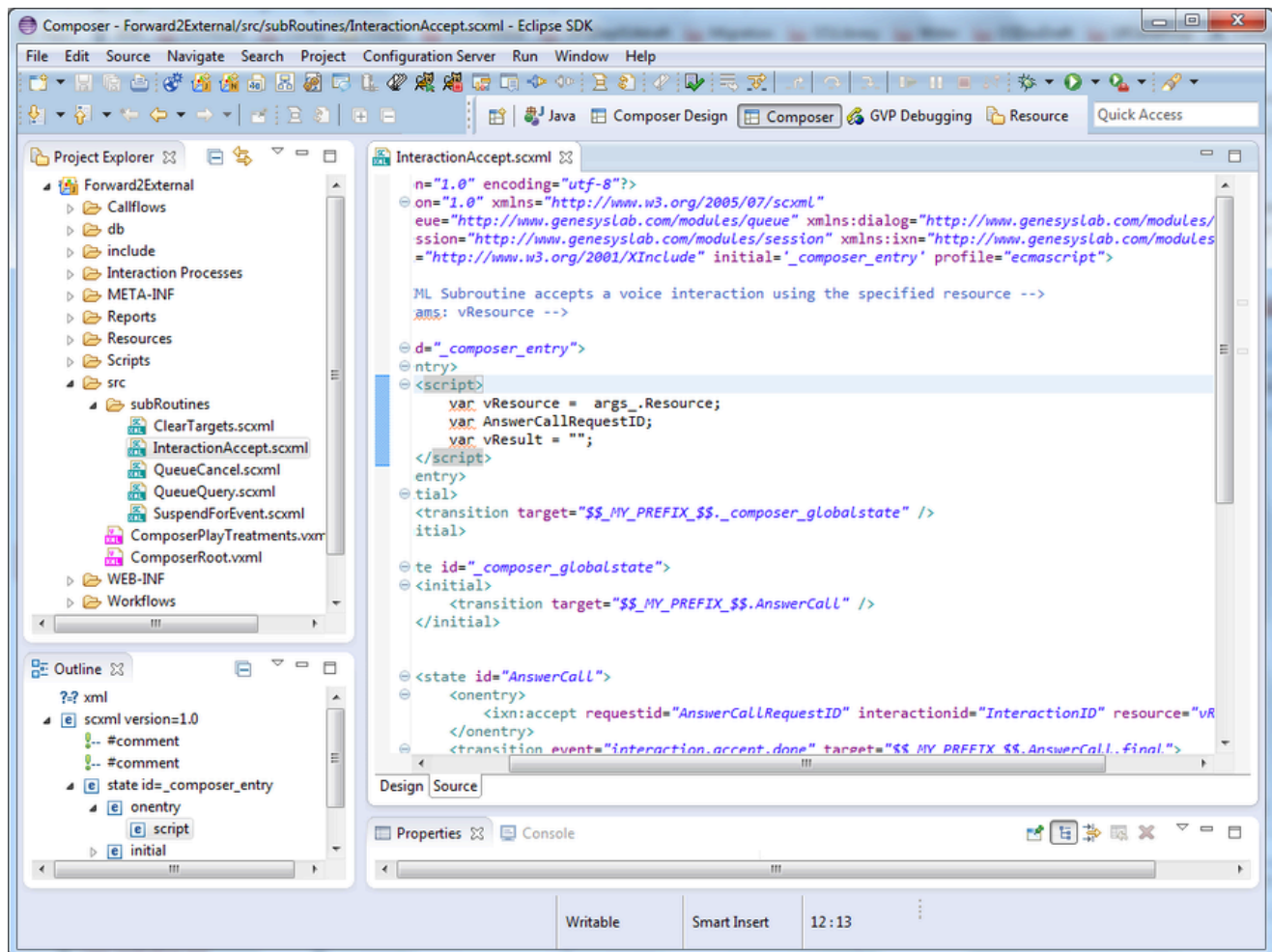

Code Editing Features

The editors provide:

- Standard editing features such as cut, copy, paste, undo, show line numbers, search and replace, bookmarks and TODO markers
- Standard Eclipse Editor features; local file history support, Team support for source code control, compare files.
- The ability to do background validation of the text as the user types, showing squiggly marks for errors as is done in Microsoft Word.
- A Validate option to validate against the schemas.
- A code snippet library with the ability for developers to add their own custom scripts.
- An outline view for quick navigation and the ability to view and edit the XML in tree format.
- Syntax coloring with the ability to customize the colors.
- A spell checking feature; a yellow squiggly line is shown below words that are misspelled.
- Quick-fix choices to fix the spelling or ignore / disable the check.
- Task tags features for setting preferences to auto scan comments with TODO in comments, and automatically add tasks corresponding to these comments.
- Context-sensitive help as the user types in the code

Using the Editors

Composer editors are embedded/integrated within the user interface and are made available to you whenever a .scxml, .vxml, .ccxml, .grxml, or .jsp file is created or accessed within Composer.

For additional information, see [Accessing the Editors and Templates](#).

Enabling/Disabling Functionality

You may hide voice application (GVP) and/or routing application development capabilities through a Composer preference setting. This feature is useful for developers who are only developing applications for GVP or Universal Routing. To hide voice or routing development capabilities:

1. Select **Window > Preferences**.
2. Expand **General** and select **Capabilities**.
3. Click the **Advanced** button.
4. In the Advanced Capabilities dialog box, expand **Composer**.
5. Check or uncheck **Composer Route** or **Composer Voice** based on your need.
 - If you uncheck **Composer Voice**, the ability to create Projects and diagrams with callflows will no longer be available. Also, perspectives and views exclusive to callflows will not be available. This means you temporarily won't be able to design voice applications for GVP until you re-enable Composer Voice capability.
 - If you uncheck **Composer Route**, the ability to create Projects and diagrams with workflows is not available. Also, perspectives and views exclusive to workflows are not available. This means you temporarily won't be able to design routing applications for Universal Routing 8.x until you re-enable Composer Route capability.
6. Click **OK** in both dialog boxes.

Hiding File Types and Blocks

You can hide Composer file types by using basic Eclipse functionality in Composer. This may be desired when certain functionality is not applicable to your environment. For example, when using Voice capabilities, and VXML is used but not CCXML, you may wish for the CallControlXML file type to be hidden from the File > New menu. The following steps may be used:

1. Select **Window > Customize Perspective**. The Customize Perspective dialog appears.
2. Click the **Shortcuts** tab.
3. Expand **Composer** and check **Others**.
4. In the list of shortcuts, uncheck **<file-type>**, where **<file-type>** is the type to be hidden.
5. Click **OK**.
6. Repeat for other perspectives if desired.

This customization is specific to the **workspace**. If you use other workspaces, you must customize them as well. This is base Eclipse behavior where customization is saved within the workspace.

Hiding Diagram Building Blocks

You can also customize the palette of diagram-building blocks. Right-click a block category (such as **Flow Control**) and select **Customize**. You can then hide and unhide blocks in that category.

Hiding/Displaying the Palette

Should you accidentally cause the palette to disappear, click the Hide/Show Palette (right-pointing) triangle.

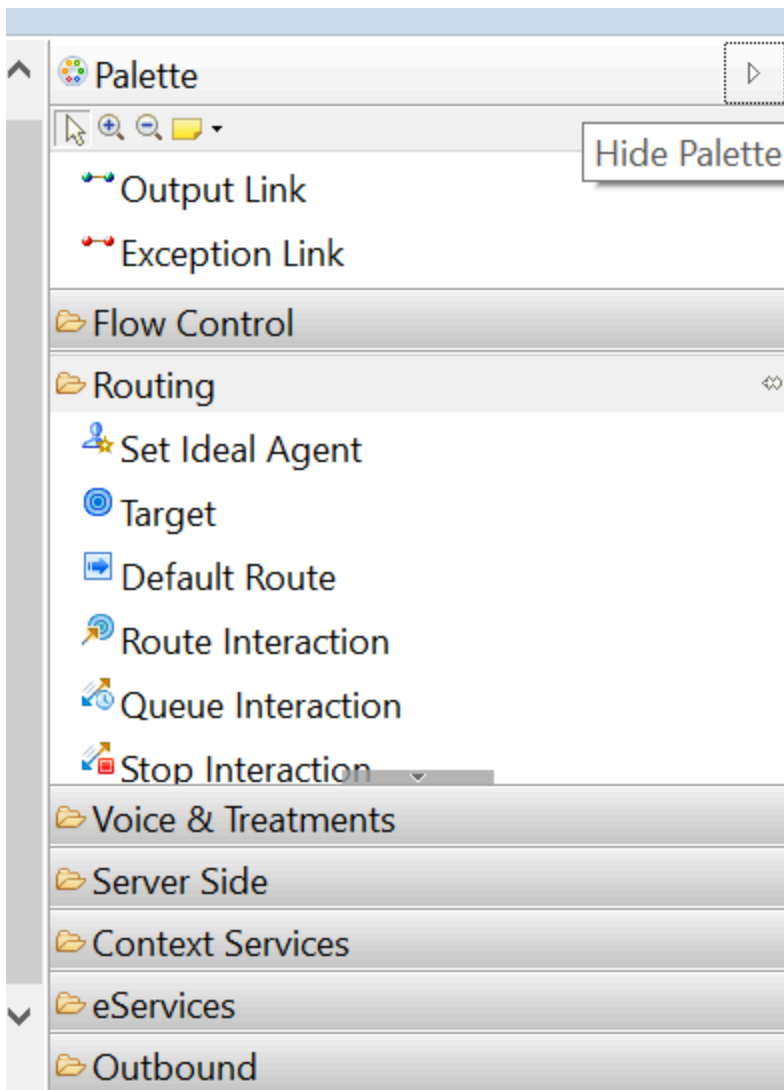

Localization

The information below describes translating various elements of the Composer user interface in your preferred language. For information on translating the entire user interface in French Canadian, see [Language Locales](#) in the *Composer 8.1.4 Deployment Guide*.

Important

To localize Eclipse IDE supplied strings, installation of Eclipse language packs is required. You can download the required Eclipse language packs from [Eclipse Babel Project Downloads](#).

Limitations

There are some limitations to localization, which are detailed here.

Translating the Palette

After installing the Composer Language Pack, if you open Composer and continue to use an existing [workspace](#), you will discover that the [Palette](#) is not localized. This is because Palette [customization](#) happens within Composer. You can change the labels, descriptions, and visibility of individual tools in the Palette. Composer preserves your customizations and, for that reason, Composer keeps the settings of your workspace Palette even after a Language Pack is installed. To work around this issue, you can perform one of the following actions.

1. Start a new workspace. The Palette will be localized in the new workspace.
2. If you are willing to lose your current Palette settings:
 - Shut down Composer.
 - In a file explorer, go to `<workspace>\.metadata\plugins\com.genesyslab.composer.diagram`, where `<workspace>` is your Composer workspace.
 - Delete the file `paletteSettings.xml`.
 - Restart Composer. The Palette will be localized in your existing workspace.

Translating Diagram Properties

The diagram preferences shown below use the Eclipse GMF runtime preferences, including their message strings. Due to limitations in Eclipse related to translating GMF Runtime, when localizing, certain diagram preferences are not translated.

- Window > Preferences > Composer > Composer Diagram > **Appearance**

- Window > Preferences > Composer > Composer Diagram > **Connections**
- Window > Preferences > Composer > Composer Diagram > **Pathmaps**
- Window > Preferences > Composer > Composer Diagram > **Printing**
- Window > Preferences > Composer > Composer Diagram > **Rulers and Grid**

Translating Enumeration Properties

In the **Properties view**, many properties of blocks are enumerations, which are collection of fixed values, from which one is selected. Internally within Composer, a number of different dialogs, drop-down boxes, and various other mechanisms are used to display the various enumeration properties. The 8.1.3 release of Composer does not to enforce uniform behavior when translating enumeration properties. As a result, some enumeration properties will appear localized, while others may not. This has no impact on diagram validation, code generation, or runtime behaviour. It is merely the values displayed in the Properties view that appear either translated or untranslated. The underlying code that is generated will always be the same.

East Asian Characters

If you are using characters from an East Asian language (for example, Chinese, Japanese, Korean) in **Expression Builder**, you may find that they do not display properly, and appear as squares rather than the expected characters. The most likely cause of this issue is that the operating system font does not support East Asian language characters. As a workaround, change the Dialog Font setting from within Composer.

1. In Composer, go to **Window > Preferences**.
2. Select **General > Appearance > Colors and Fonts**.
3. In the preference dialog, select **Basic > Dialog Font**.
4. Click **Edit** to bring up the font selection dialog.
5. Choose a font which can render East Asian languages, such as Arial Unicode MS.
6. Click **OK** on the font selection dialog, then click **OK** on the preferences dialog.

Connection Profile and Non-ASCII Characters

Database Connection Profiles do not support non-ASCII characters. Use only ASCII characters when creating Connection Profiles.

Composer Compared to IRD

Here is a short video on the advantages of moving to Composer from Interaction Routing Designer as well as an interface comparison.

Composer Compared to IRD

[Link to video](#)

Integrated Development Environment

- Composer is a single **Integrated Development Environment** (IDE) for creating applications to routing interactions as well as to orchestrate the entire customer experience. Composer-created voice and routing applications can command and control the customer experience through all channels (IVR, voice, e-services, and so on).
- Composer's open framework enables widely-available, existing competencies to be used to create reusable components that manage the customer experience. The IDE allows both customers and integrators to utilize existing code sets (HTML, VXML, java, perl, REST and others) to control the customer experience.
- The open framework also allows simplified integration into all Enterprise applications to harness the information within the Enterprise to drive and personalize the customer experience.

Session-Based Versus Interaction-Based

Composer works with the Orchestration Server platform, which is **session-based** as compared to the **Universal Routing Server** (URS) platform, which is "interaction based." A session can last for the length of the customer journey, across multiple interactions. URS only executes strategies (workflows) that interact on a single interaction. In contrast, ORS does not need to have an interaction to perform useful functionality. All ORS requires is an API call in order to execute. In this manner, the ORS platform can be thought of as a general purpose workflow platform to control the workflow regardless of whether or not you have an interaction (email, SMS, mobile, social, voice, and so on).

Differences from IRD

In the past, Universal Routing's **Interaction Routing Designer** was the only Genesys tool to create routing applications. Genesys Composer is now the tool of choice for creating both routing and voice self-service applications.

A few of the differences between Composer and Interaction Routing Designer are listed below.

- Composer is **integrated** with **Orchestration Server** allowing you to manage customer conversations spread out over time using the ORS **session-based functionality and persistent storage** as well as **Orchestration Extensions**.
- Composer encompasses **IRD's functionality** and much more **routing functionality** in general.
- Composer lets you create routing applications using an open language (SCXML) and ECMAScript for decision-making. In contrast, IRD uses a closed Genesys proprietary language (IRL) and you are limited to IRD's objects and functions.
- Composer gives the option of writing your own **SCXML code** and/or using **predefined blocks**.
- Unlike IRD, you can also use Composer to create **voice self-service applications for Genesys Voice Platform**, including VoiceXML and CCXML-based applications. You can also create integrated voice and routing applications.
- Any routing application created in IRD can easily be created in Composer.

Composer Routing Application Types

You can use Composer's **predefined blocks** and/or write your own SCXML code to create routing applications that route based on various criteria such as:

- **Agent, Agent Group, ACD Queue, Place, Place Group, Route Point, Skill, or Variable**
- **last called agent**
- **date and time**
- **the value of a statistic,**
- **dialed number (DNIS)**
- **originating number (ANI)**
- **percent and conditional routing**
- **Service Level Routing**

The above list is by no means complete. It represents only a few types of routing applications that can be created in Composer. Since Composer uses open languages (SCXML and ECMAScript), you are not limited to its pre-defined blocks, but are free to create many types of routing applications.

Composer Blocks Mapped to IRD Objects

Composer refers to the fundamental element of a workflow as a *block* whereas in IRD documentation, this element is referred to as an *object*. A few IRD object/Composer block equivalents are presented below. The tables group IRD objects based on their IRD toolbar category name and point to the corresponding functionality in Composer.

Tip

For a complete list of Composer blocks, including all those without an IRD equivalent, see [RoutingBlockPaletteReference](#).

IRD Data & Services

IRD Object Name	Composer Block Name	Description
Database Wizard	DB Data	DB Data retrieves information from the database. Uses a Query Builder .
Web Service	Web Service	Invokes Web Services. GET, POST and SOAP over HTTPS are supported.
	Web Request	Invoke any supported HTTP web request or REST-style web Service. See sample: Routing Based on Web Request .

IRD Miscellaneous

IRD Object Name	Composer Block Name	Description
Assign Multi-Assign	Assign	Assigns a computed value/ expression or a literal value to a variable. Variables are defined in the Entry block. Capable of multiple assignments.
Call Subroutine	Subroutine	Creates reusable sub-modules.
Entry	Entry	Sets global error (exception) handlers. Defines global variables (see Variables section below).. All routing strategy diagrams must start with an Entry block.
Exit	Exit	Terminates the strategy and returns control back to calling workflow in case of a subroutine.
Error Segmentation	Multiple error output ports can be created in Composer blocks based on each block's Exception property.	
Function Multi-Function	ECMAScript	Builds an ECMAScript expression using the Expression Builder . Many URS functions are available as Genesys Functional Modules described the Orchestration Server

		Documentation Wiki Can invoke multiple functions.
If	Assign , Branching , ECMAScriptBlock blocks all open Expression Builder	Expression Builder can be used to create IF expressions.
Multi-Attach	ECMAScript	Can be used for attaching data to an interaction.

IRD Routing

IRD Object Name	Composer Block Name	Description
Selection	Target	Routes an interaction to a target, which can be Agent, AgentGroup, ACDQueue, Place, PlaceGroup, RoutePoint, Skill, or Variable. Skill target uses Skill Expression Builder .
Percentage	Target	Statistics Order property in Target block, lets you perform percentage allocation. Also see sample: Routing Based on Percent Allocation .
Default	Default Route	Routes the interaction to the default destination.
Routing Rule		Orchestration Server 8.1 does not support service level routing rules.
Switch to Strategy		Orchestration Server 8.1 does not support switch to strategy routing rules.
Force Route	Force Route	Not exposed as a routing rule in Composer.
Statistics	Target	Although statistical routing rules are not yet supported as in IRD's Statistics routing object, users can use the Target object Statistic property to route based on the value of a statistic. A Statistics Manager and Builder let you create your own statistics from URS predefined statistics.

IRD Segmentation

IRD Object Name	Composer Block Name	Description
ANI	Branching	See YourFirstApplication: DNIS Routing for an example.
DNIS	Branching	See Your First Application: DNIS Routing for an example.

Date	Branching	See the sample: Routing Based on Date and Time .
Day of Week	Branching	See the sample: Routing Based on Date and Time .
Time	Branching	See the sample: Routing Based on Date and Time .
Classification Segmentation	Branching	For classification segmentation, an ECMAScript function determines if a particular category name or ID exists in the array of category objects represented by an application variable.
Generic	Branching	Use as a decision point in a workflow. It enables you to specify multiple application routes based on a branching condition.

Also see [Context Services Blocks](#).

IRD Voice Treatment

See [Composer Equivalent to IRD Treatment](#).

IRD Multimedia

See [Composer Equivalent to IRD Treatment](#).

IRD Outbound

See [Outbound Common Blocks](#)

Context Services

See [Context Services Blocks](#)

Business Process

See [Interaction Processing Diagrams Overview](#) and [Interaction Process Diagram Blocks](#).

Reusable Objects

- IRD List Object: See Composer's [List Object Manager](#).
- IRD Variable List Dialog Box: See Entry block [Variables](#) property.

In contrast to IRD, which defines variables in a special dialog box outside of the strategy, Composer

defines both **workflow** and **Project variables**.

Getting Started with Composer

This section is your first stop for getting started with Composer. It discusses the following topics:

- [Running Composer for the First Time](#)
- [Software Updates Functionality](#)
- [Integrating with Source Control Systems](#)
- [Composer Projects and Directories](#)
- [Working with Diagram Layouts](#)
- [Accessing the Editors and Templates](#)
- [Multiple User Environments](#)
- [Security Configuration](#)
- [Upgrading Projects/Diagrams](#)
- [Keyboard Shortcuts](#)
- [Default Logging](#)
- [IRD Functionality Included in Composer](#)

Also see: [Composer 8.1 Routing Applications User's Guide](#)

Running Composer for the First Time

When running Composer for the first time, check out the video [Getting Started After Installation](#). Composer is built on [Eclipse](#). If you have not already done so, run Eclipse as described in the video.

Workspaces

When you run Composer, before the user interface appears, a dialog box opens with a suggested *workspace*, which is a location (folder) for your projects and files in addition to any special folders that Eclipse needs to maintain for its internal bookkeeping. The dialog box gives the option of changing the workspace to a different location. New projects created in Composer will be created under this workspace as subfolders. After the Composer interface opens, the [Project Explorer](#) shows this location. You can change this location by selecting **File > Switch Workspace**.

Important

- Genesys recommends that the workspace folder name has no spaces in its path (for example, c:\comp81dev). This recommendation is not required and Composer does not enforce this. Genesys also recommends using the component version in the name to avoid confusion during upgrades.
- When prompted for a workspace folder, do not specify parenthesis in the workspace path.
- The workspace should not be located in a ClearCase view, as this will cause problems accessing files later during development.

Setting Up Your Workspace

The first time you open Composer, it asks you to specify the location of your workspace. Eclipse remembers this location and will present it for all subsequent times when you open Composer. If you do not wish to be prompted each time for this path and plan to use the same location for all your projects, you can check the Use this as the default and do not ask again option to skip this screen on future launches.

Welcome Screen

When a new workspace is created for the first time, you will be taken to the Welcome screen, which provides getting started overview topics, tutorials and links for references on the Web. The next time you open Composer, if the Welcome screen still opens, close it by clicking the "x" on the Welcome tab. To go back to the Welcome screen at any time:

- Select **Help > Welcome**.

Opening Composer Perspective

Select **Window > Perspective > Open Perspective > Other**. All **perspectives** (views) available in Eclipse are listed, including those not used by Composer. Select **Composer** perspective.

Software Updates Functionality (Plugins)

You can find information on installing new software (such as for Dynamic Web Projects or updating existing plug-ins in the Eclipse help. For example, using "update software" as search words displays plugin topics in the Eclipse *Workbench User Guide* (**Help > Contents**).

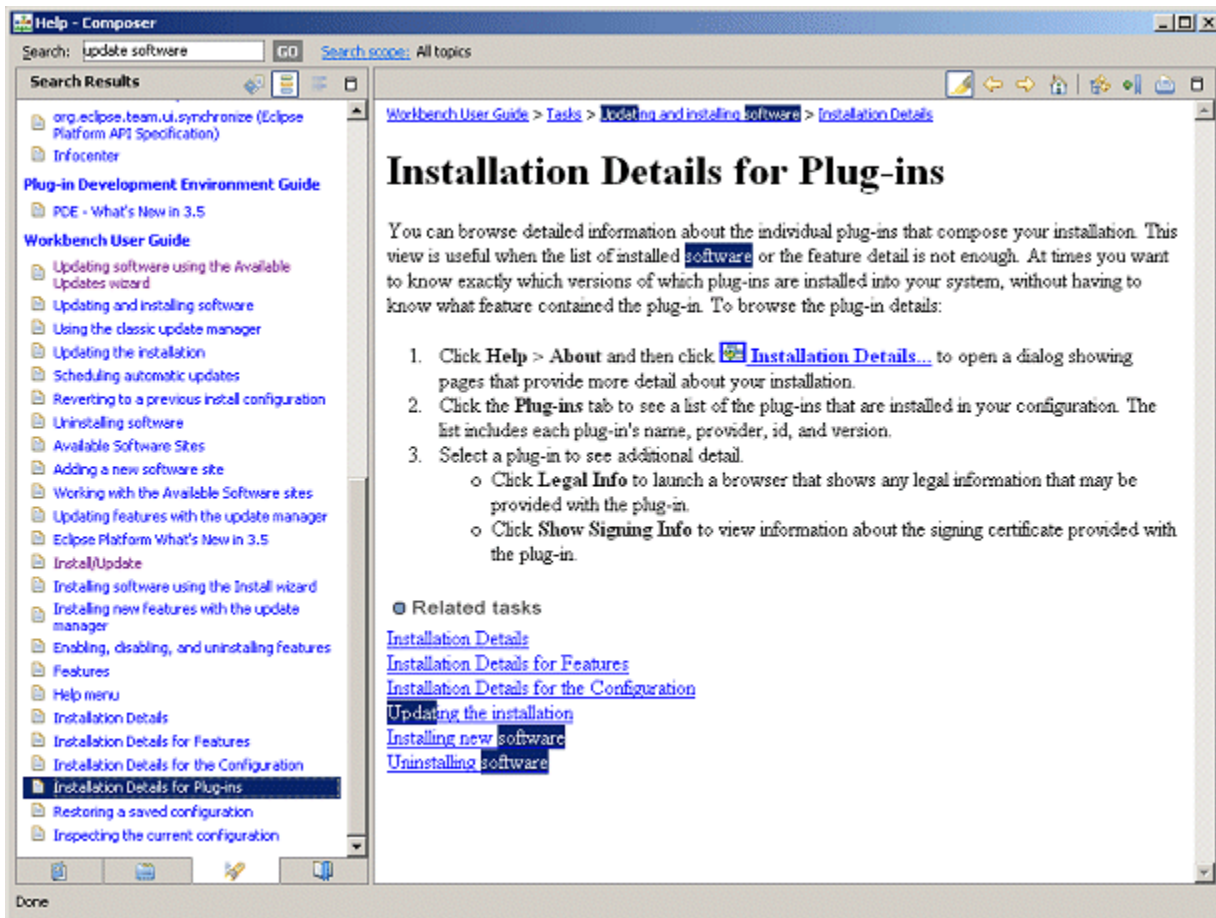

Plugin Installation Requirements

It is standard Eclipse behavior for plugins to be installed in C:\Program Files\... (i.e. the base Composer installation directory), and NOT in the user's workspace. The installation of plugins must be performed by an admin user.

Dynamic Web Projects

After you install Java EE Developer Tools plugins, you can create a Dynamic Web Project containing pages with active content. Unlike with static Web Projects, dynamic Web Projects enable you to create resources such as JavaServer Pages and servlets. Here's how to get started:

1. **Composer Help >> Install New Software.**
2. Click **Add**. In the resulting box, enter <http://download.eclipse.org/releases/galileo/>
3. Select it to see the available package.
4. Select the **Web, XML, and Java EE Development Eclipse Java EE Developer Tools** entry.
5. Install the plugins.
6. Restart Composer.
7. Create a Dynamic Web Project.

Note: Other missing project types can be similarly enabled.

Integrating with Source Control

This section describes setup instructions for using source control with Composer. The ClearCase source control system is supported as well as Subversion.

ClearCase Plug-in Installation

To install ClearCase plug-ins for use with Composer:

1. Install ClearCase on the machine that Composer will run on.
2. Exit Composer. If you want to print these instructions to use after closing Composer, click the Print Page icon at the top-right of the Eclipse Help window.
3. Install the ClearCase Eclipse plug-in from IBM:
 - a. Get the following files from IBM's website: `com.rat.cc.win32-20080131A.zip` and `com.r.cc.ccrefresh.all-20061107.zip`

http://www.ibm.com/developerworks/rational/library/content/03July/2500/2834/ClearCase/clearcase_plugins.html

Note: Actual ZIP file and directory names may change as IBM continues to update the plug-ins. These documented names are current at the time of this writing. These plug-ins are for Eclipse v3.3 and not 3.4. Even though Composer 8.1. is based on Eclipse 3.4, Genesys recommends that you install the plug-ins listed for Eclipse 3.3.

- b. Extract the two ZIP files to a location of your choosing, essentially merging the contents. There is a duplicate file `.eclipseextension` in the two ZIPs; you can safely ignore that file. The ZIP files, when extracted, create a directory structure like:

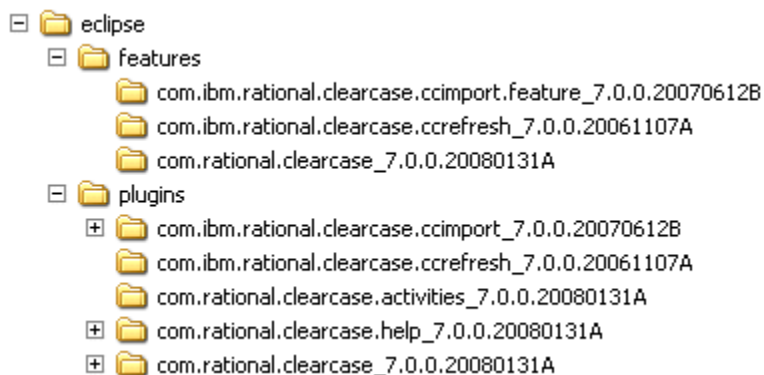

- c. If it does not already exist, create the directory `${Composer 8.1.Install}\features`, where `${Composer 8.1.Install}` is the installation root of your Composer 8.1 installation. For

example, `${Composer 8.1.Install}` might be `C:\Program Files\GCTI\gvp\Composer 8.1`

- d. From the directory where the ZIP files were extracted, copy the folders in the features directory to `${Composer 8.1.Install}\features`, and copy the directories in the plugins directory to `${Composer 8.1.Install}\plugins`.

Note: Instead of dropping the extracted zip file content in these two locations, you may place the entire (eclipse folder) extracted content in the following folder location `${Composer 8.1.Install dir}\dropins`.

4. Ensure that ClearCase capabilities are enabled.
 - a. Go to **Window > Preferences > General > Capabilities**.
 - b. Make sure that the **Team** checkbox is checked. It must be checked in order for **ClearCase MVFS Support** and **ClearCase SCM Adapter** preference items to appear in the Preferences window. Please note you must restart Composer to see the changes.
5. Enable MVFS Support:
 - a. Start Composer.
 - b. Select **Window > Preferences > Team > ClearCase MVFS Support**.
 - c. Click the **Workspace** link under **MVFS Support Preferences** and select the **Refresh Automatically** check box.
 - d. Click the Apply button.
 - e. Click **OK** to close the Workspace dialog box.
 - f. Again, open **Window > Preferences > Team > ClearCase MVFS Support** and make sure that **Enable ClearCase dynamic view file system support** is selected, then click **OK**.
6. Configure the ClearCase plug-in. Configuration can be accessed from **Window > Preferences > Team > ClearCase SCM Adapter** from the tree in the left-side panel. The recommended settings are shown in the image below:

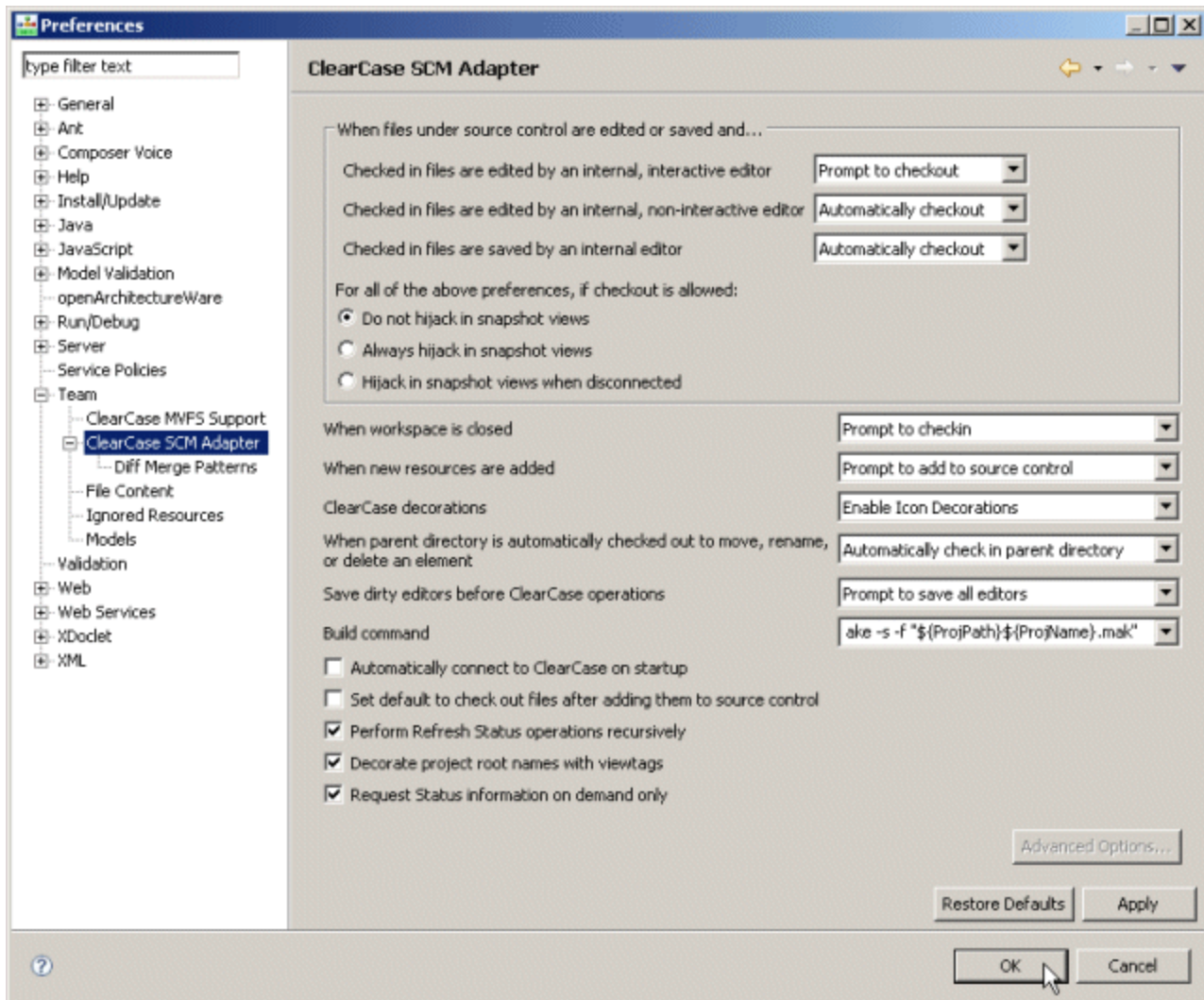



Note: You can read more about ClearCase features and working with ClearCase view from the help topic Rational ClearCase SCM Adapter available from the Eclipse Help system. These help topics will be available only after installing ClearCase plugins.

ClearCase Usage

To use ClearCase functionality within Composer:

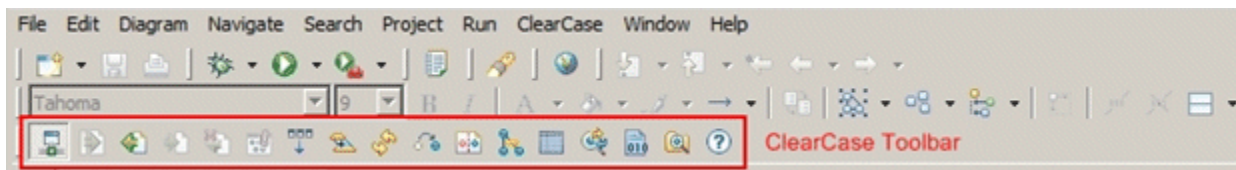
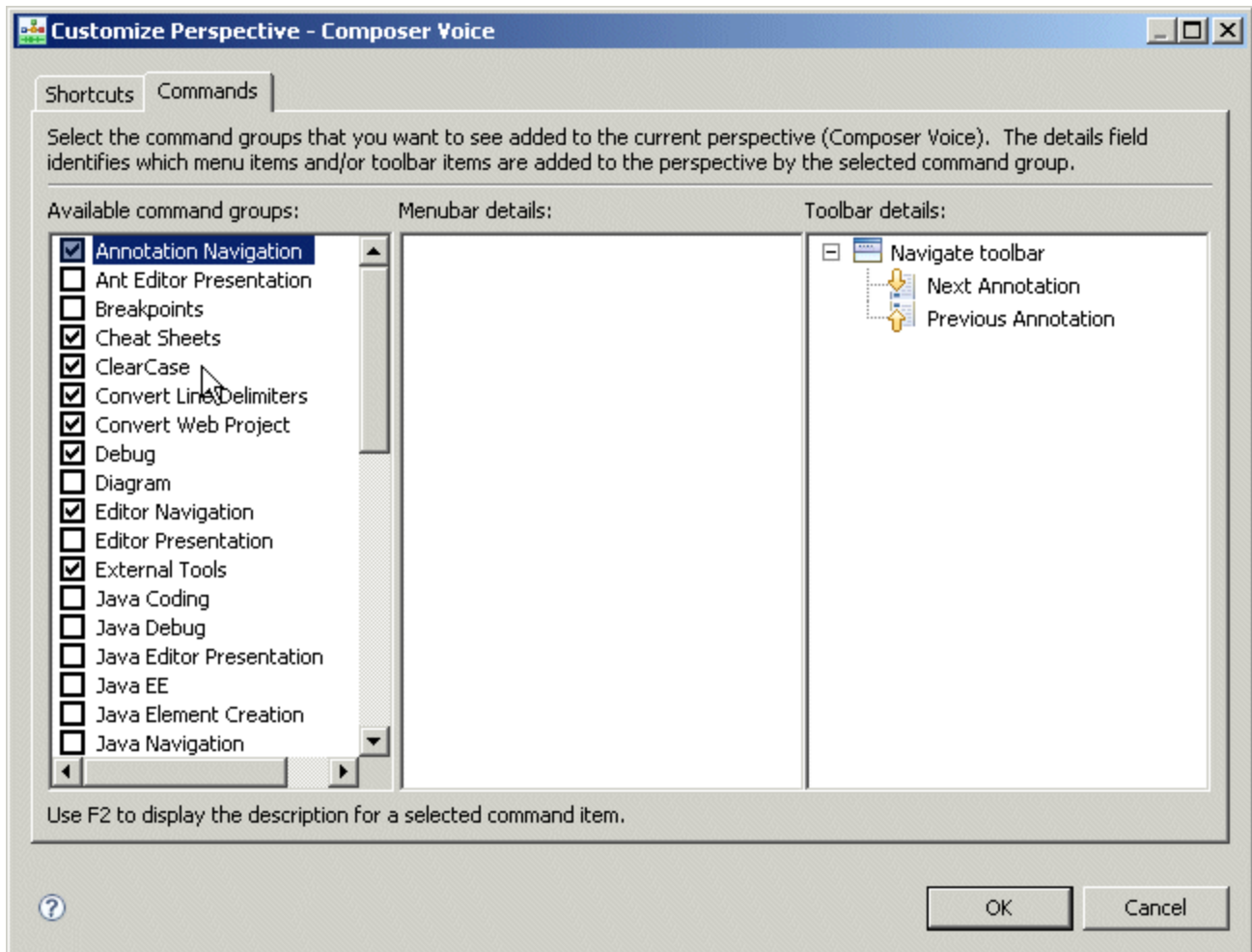
1. Create a view using ClearCase Explorer, or use an existing view.
2. In Eclipse, if you don't see the ClearCase toolbar, make the toolbar appear by clicking **Window** > **Customize Perspective**. In the dialog box that displays, click the **Commands** tab, select the **ClearCase command group** and click **OK**.



3. Once the toolbar is available, click on the  button.

After this, any Composer Project that resides in a ClearCase view will have the view name displayed next to it in the Project Explorer window. Also, the icons for files and folders under source control will show the status, such as checked out, hijacked, and so on.

Creating a Composer Project Managed by ClearCase

To create a new Composer Project that will be managed by ClearCase:

1. Bring up the Project wizard (**File > New**).
2. Clear the **Use default location** check box and enter in the **Location** field a path that resides inside your ClearCase view.

The path becomes the root of the Composer Project. Note that the files in the new project will not be checked into ClearCase until you use the Add to Source Control function.

To add a project that is already checked into ClearCase to your Composer 8.x workspace:

1. Use the Import wizard (**File > Import**).
2. Select **Existing Projects into Workspace**.
3. In the **Select root directory** field, enter the path of the project residing in your ClearCase view. Check the box corresponding to the Project name.

Important: Leave the **Copy projects into workspace** box unchecked. If it is checked, the imported project will not be under ClearCase control.

To edit a file that is under source control, it must be checked out from ClearCase. After editing, it can either be checked in to create a new source control version, or the checkout can be undone to revert the file back to its previous version. You can also compare changes to the previous version before checking it. All of these operations can be accessed in several alternative ways:

- Right-click the file name in Composer's Project Explorer view, and use the **Team** submenu.
- Select the file in Composer's Project Explorer view, and use the **ClearCase** menu on the top menubar.
- Select the file in Composer's Project Explorer view, and use one of the buttons on the ClearCase toolbar.

Note: If you choose to remove a ClearCase-managed Composer Project from your workspace, you will be prompted with a Confirm Project Delete message. Genesys strongly recommends that you choose the **Do not delete contents** option. This leaves the files in your ClearCase view untouched. Otherwise, the files may be removed from source control.

Subversion Configuration

Subversion is a client-server versioning system. You can integrate Subversion with Composer in order to have a version control over Projects. Subversion creates and maintains a repository on the Project web server. Its clients run on Composer machines and connect to the Subversion server over the Internet.

Note! The integration steps below are not version-specific or Composer-specific. The steps refer to the interface and capabilities provided by the Eclipse Integrated Development Environment (IDE) (Subclipse Team Provider plug-in) and CollabNet (CollabNet Subversion Server) products.

The recommended steps are as follows:

1. Install and Configure Subversion Server.
2. Download the Collabnet Subversion server from the website: <http://www.collab.net/downloads/subversion/>

3. Follow the installation and configuration instructions from the vendor for the operating system you are working with. Complete registration if required. When the installation executable runs, the wizard has an option to View Installation Information.

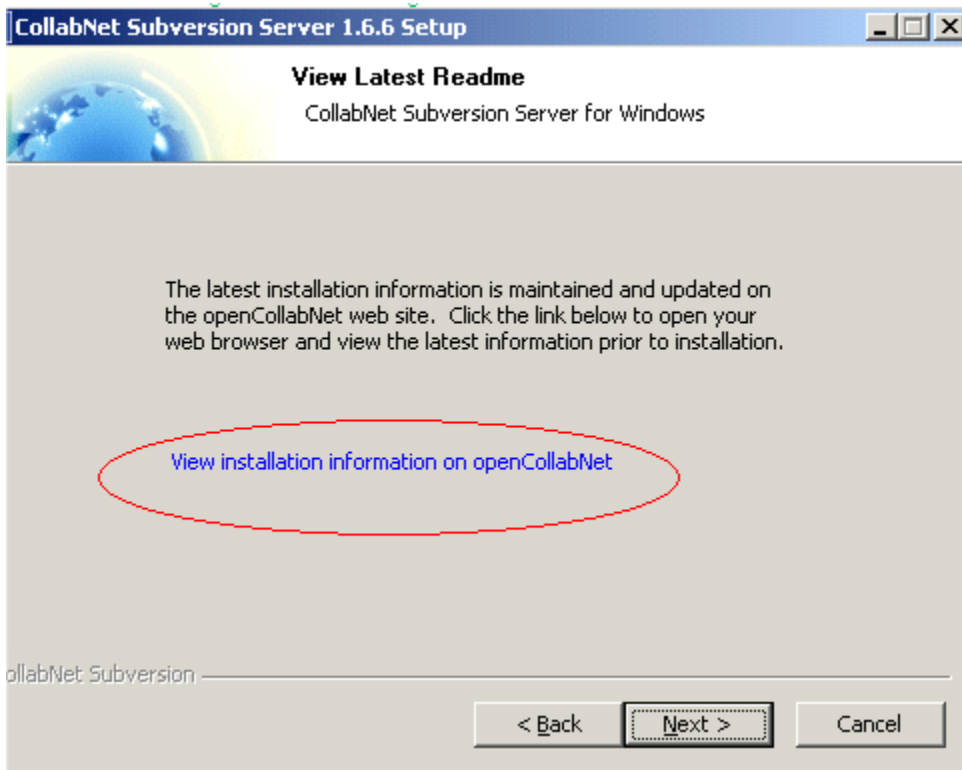

Note: If you are running IIS on the server machine during installation of Collabnet Subversion server, you may wish to change the Apache port to “81” instead of the default 80 to avoid conflict.

4. Follow post installation instructions from the vendor and complete Collabnet Subversion server configuration.
5. Configure the Subversion repository. Follow the instructions provided by the vendor (<http://www.collab.net/downloads/subversion/>) to define the permissions, user name, and password for accessing the repository. Use the instructions for the specific version of the Callabnet Subversion server that you installed in step 1.

Note: Subclipse provides an option for creating a repository, but this is more suited for personal development where you do not need to share your code. Typically, you would set up a Subversion server, create the repository on the server and then point Subclipse at the server.

6. Install the Subversion client using the capabilities of Eclipse by adding Subclipse to the Eclipse IDE. Subclipse is a project to add Subversion support to the Eclipse IDE. Use Eclipse's Software Manager to add Subclipse to our Eclipse IDE.
 - a. Add the Subclipse update version compatible with Subversion server installed in step 1.
 - b. From Composer's Help menu, choose **Install New Software** to open the Install wizard.
 - c. Select the required Subclipse update from the site: (http://subclipse.tigris.org/update_1.6.x/)

Note: The above link may not be current. In this case, check the <http://subclipse.tigris.org/> site. The Download and Install section lists update sites for various Eclipse versions. Choose the correct site based on the Eclipse version for Composer. Composer's Eclipse version can be determined from **Help > About** and clicking the Eclipse.org icon.

- d. Click on the **Download** link to go to the download page. There you will find the URL to enter into the Eclipse Install wizard.
 - e. Follow the wizard and instructions provided in the **Help > Contents > Workbench User Guide** for installing new software.
 - f. Restart Composer if required by installer.
7. Create the CVN (Subversion) item in Composer menu bar. Follow the Eclipse instructions on customizing perspectives /creating command groups (**Help > Contents > Workbench User Guide > Concepts > Perspectives > Configuring perspective command groups**).
 8. Define CVN repository location to your Eclipse IDE. Follow the instructions provided in **Help > Contents > Workbench User Guide > Getting Started > Team SVN Tutorial**. Use the instructions for Specifying a project location.

For more details working with CVN, please, see Help: **Subclipse - Subversion Eclipse plugin**.

Checkin Error

If you are using Source Control tools, checking in Composer Projects contents after a Project Upgrade may results in an error. See [Checkin Error During Source Code Integration](#).

Project Types and Directories

A Composer *Project* is associated with either:

- A voice application for [Genesys Voice Platform](#) or
- A routing application for the [Orchestration Platform](#).

In general, a Project consists of a predefined, structured set of files and folders that contain all resources for the application. See the **Project Explorer** below.

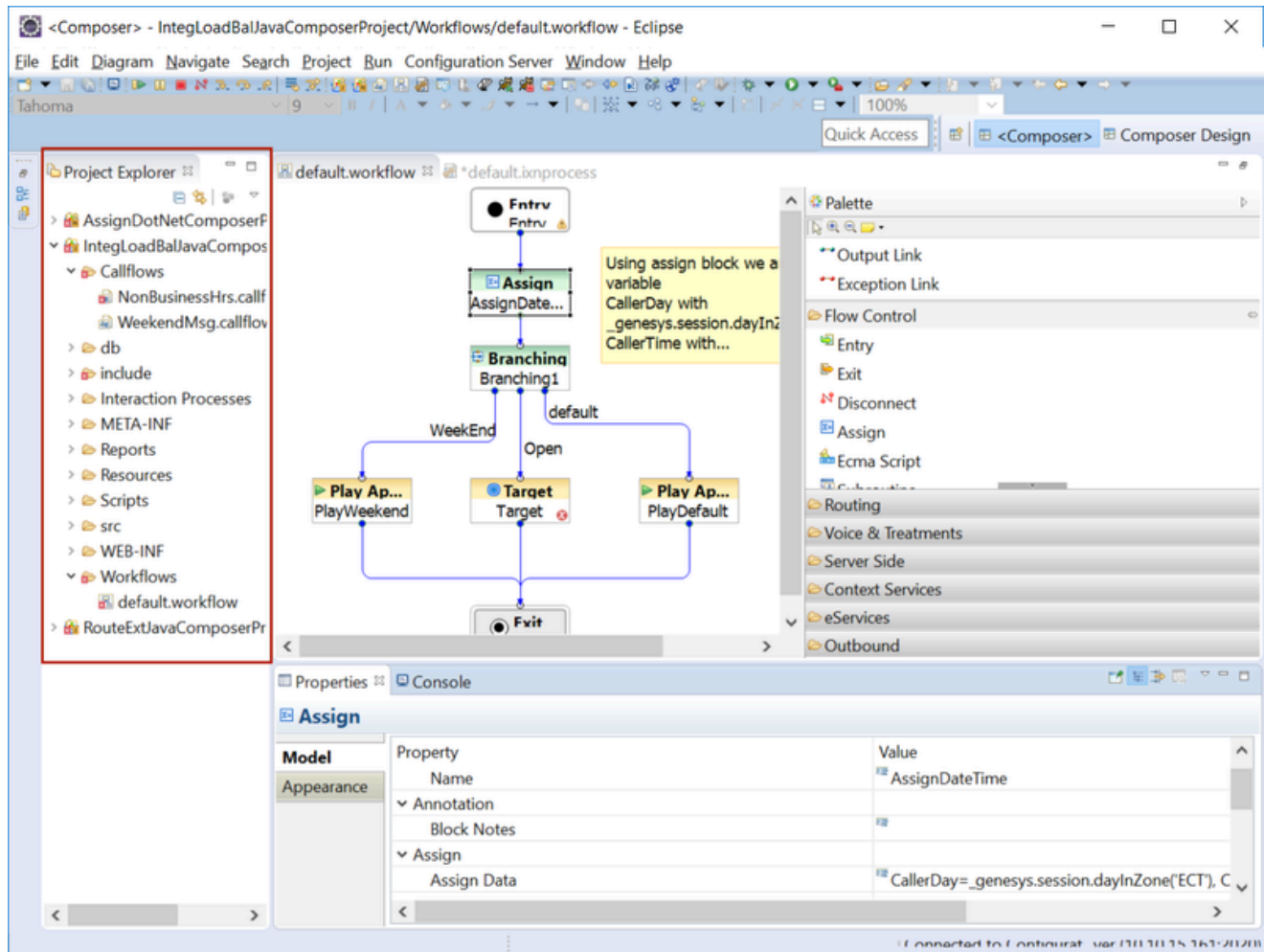

For information on Projects referencing other Projects, see the figure in topic [Project Properties dialog box](#). Expand Project References.

Java and .NET Projects

There are two types of Composer Projects:

- **Java Composer Projects** -- Use JSP and Java to implement custom business logic. These Projects can be **deployed** on web applications servers as described in the [Composer 8.1 Deployment Guide](#). See [Creating a New Project](#).
- **.NET Composer Projects** -- Use ASP.NET and C# to implement server-side blocks and custom business logic. The Project can only be **deployed** to Microsoft IIS. See [.NET Troubleshooting](#) for steps for working with Composer .NET Projects when a machine does not have WSE 3.0.

Starting a New .NET Project

To start a new .NET Project:

1. Click the Create a NET Composer Project button in the menu bar. You can also click the button above the Project Explorer and select **Composer > Composer > Projects > .NET Composer Project**.
2. In the Project dialog box, type a name for your Project.
3. If you want to save the Composer Project in your default workspace, select the **Use default location** check box. If not, clear the check box, click Browse, and navigate to the location where you wish to store the Composer Project.
4. Select the Project type.
5. Click **Next**.
6. If you want to use templates, expand the appropriate Project type category and select a template for your application.

.NET Project Warning

.NET Projects may show this warning in the Console View: `include\getWebServiceData.aspx(482): warning CS0618: 'Microsoft.Web.Services3.SoapContext.Security' is obsolete: 'SoapContext.Security is obsolete. Consider deriving from SendSecurityFilter or ReceiveSecurityFilter and creating a custom policy assertion that generates these filters. This warning can be ignored and no workarounds are needed. It will not show up as an error or warning in the Problems View.`

.NET Project Logging

Starting with 8.1.410.14, .NET Project logging configuration is handled with file `web.config` located in the Project root directory. The level of logging can be changed to values:

```
OFF           The highest possible rank and is intended to turn off logging.
FATAL        Severe errors that cause premature termination. Expect these to be immediately
              visible on a status console.
ERROR        Other runtime errors or unexpected conditions. Expect these to be immediately
              visible on a status console.
WARN         Use of deprecated APIs, poor use of API, 'almost' errors, other runtime
              situations that are undesirable or
              unexpected, but not necessarily "wrong". Expect these to be immediately visible on a
```

status console.

INFO Interesting runtime events (startup/shutdown). Expect these to be immediately visible on a console, so be conservative and keep to a minimum.

DEBUG Detailed information on the flow through the system. Expect these to be written to logs only.

TRACE More detailed information. Expect these to be written to logs only.

Maven Support for Building Java Projects

Beginning with release 8.1.550.08, Composer supports Maven for building Java projects. Maven is a software project management and comprehension tool by Apache. It is a build automation tool used primarily for Java projects. Based on the concept of a project object model (POM), Maven can manage a project's build, reporting and documentation from a central piece of information. A Java Composer Maven project's structure and contents are declared in an XML file, `pom.xml`.

A new project type, **Java Composer Maven Project**, is introduced in Composer's project creation wizard for Java projects. A Maven project will inherit all the features and functionalities of a regular Java Composer project in addition to the Maven specific features.

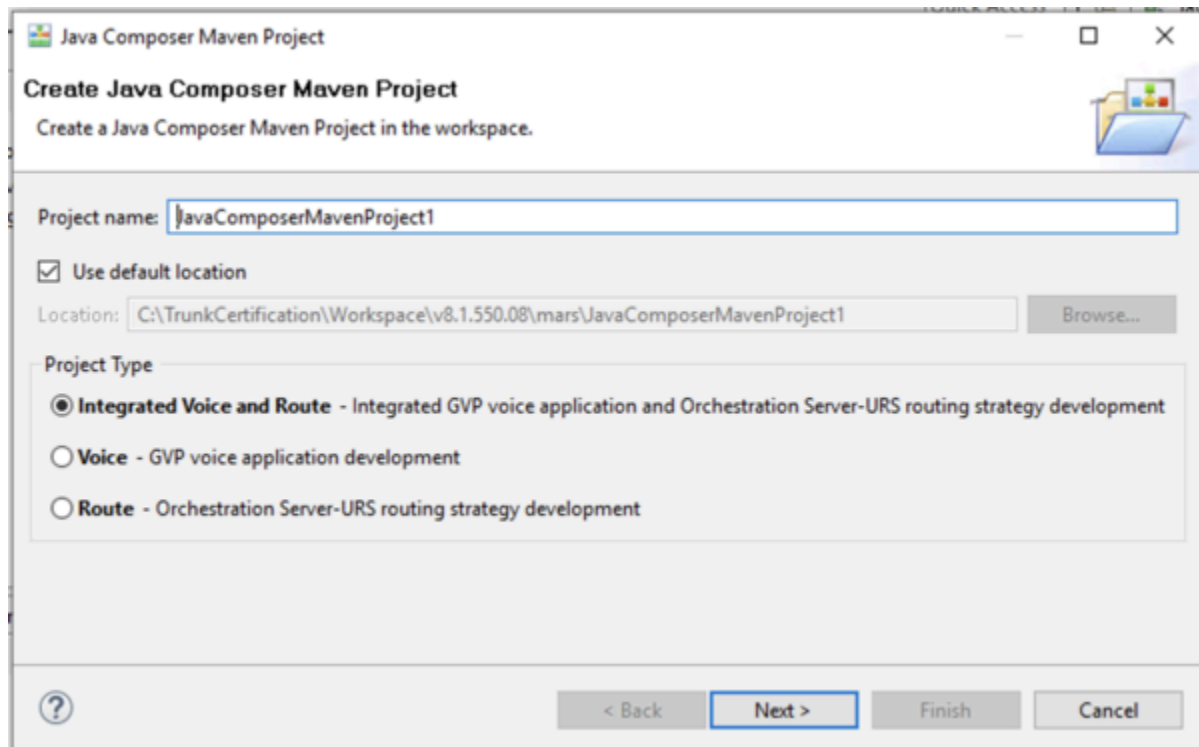

A new button is introduced in the Main toolbar to create a new Java Composer Maven project from the toolbar.



A new page, **Maven POM**, is introduced as part of the project creation wizard to specify Maven related values such as GroupID and ArtifactID.

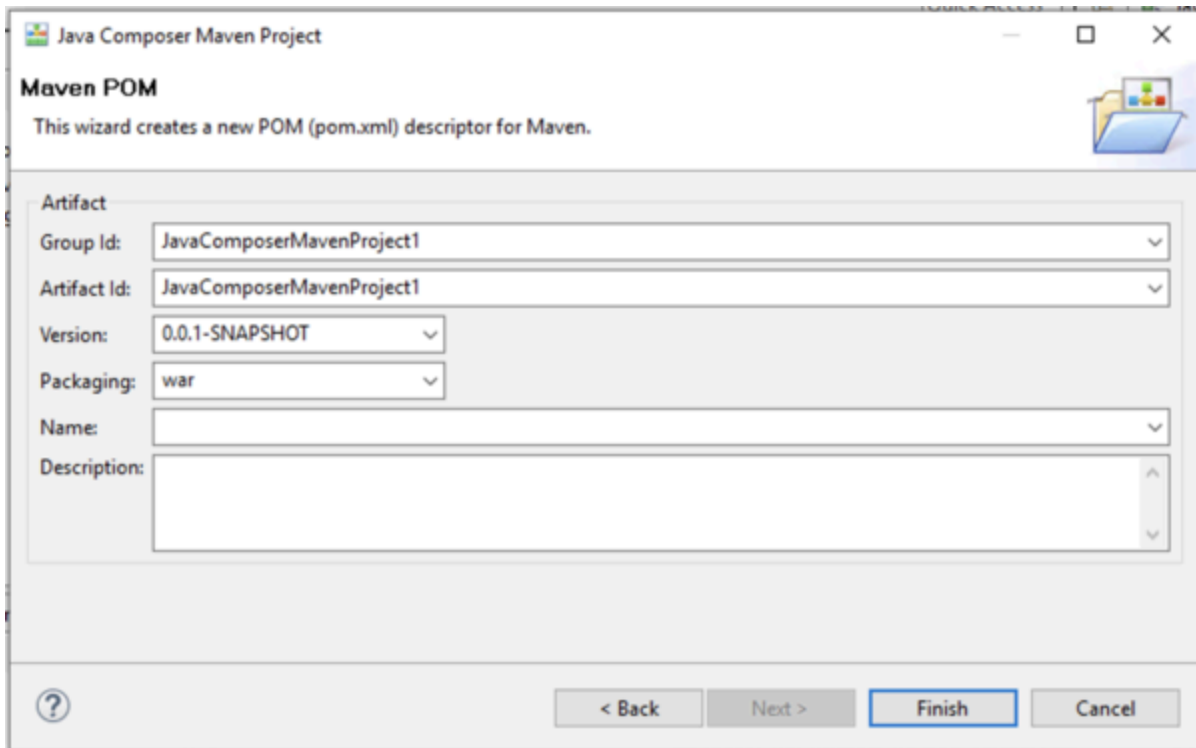

The screenshot shows a window titled "Java Composer Maven Project" with a "Maven POM" subtitle. Below the subtitle is the text "This wizard creates a new POM (pom.xml) descriptor for Maven." The main area contains several input fields: "Group Id:" with the value "JavaComposerMavenProject1", "Artifact Id:" with the value "JavaComposerMavenProject1", "Version:" with the value "0.0.1-SNAPSHOT", and "Packaging:" with the value "war". There are also empty fields for "Name:" and "Description:". At the bottom, there are four buttons: "?", "< Back", "Next >", and "Finish" (which is highlighted with a blue border), and a "Cancel" button.

Here is a short video on creating a Maven project in Composer:

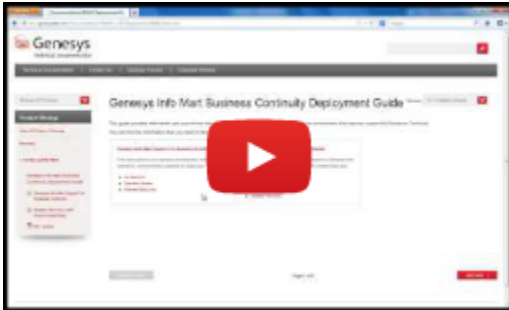

The **Maven Project Builder** is added to a Composer project on creating a new Java Composer Maven project.



The following is a sample Java Composer Maven project's folder structure.

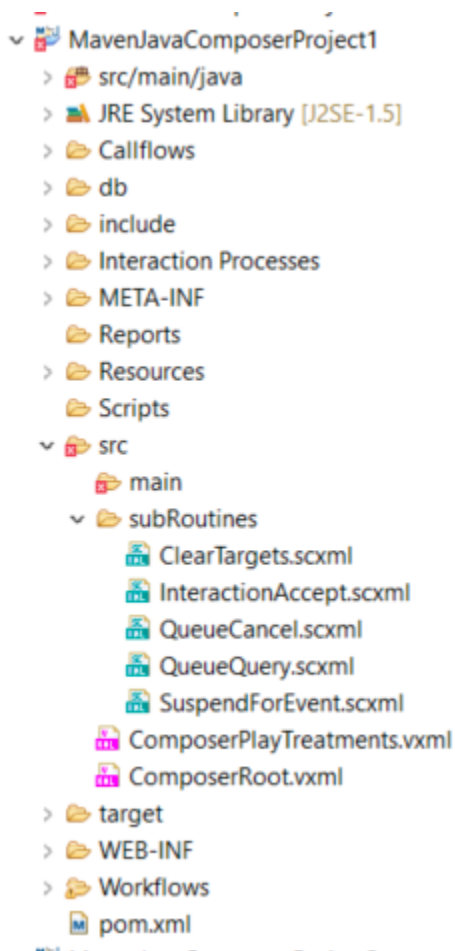

Maven Build Configuration and Goals

The Maven build follows a specific life cycle to deploy and distribute target projects. Each life cycle consists of a sequence of phases. The **default** build life cycle consists of 23 phases as it is the main

build lifecycle.

On the other hand, the **clean** life cycle consists of 3 phases, while the **site** lifecycle is made up of 4 phases.

Each phase is a sequence of goals, and each goal is responsible for a specific task.

When you run a phase, all goals bound to the phase are executed in order.

The following is a list of some of the phases and default goals bound to them:

- `compiler:compile` - the `compile` goal from the `compiler` plugin is bound to the **compile** phase
- `compiler:testCompile` is bound to the **test-compile** phase
- `surefire:test` is bound to the **test** phase
- `install:install` is bound to the **install** phase
- `jar:jar` and `war:war` are bound to the **package** phase

When using Maven to build a Java Composer project, you must specify the goal in order to be able to build the project. For example, in the screenshot below, a **clean** `compile` package has been specified as the goal:

```

Console
<terminated> MavenJavaComposerProject [Maven Build] C:\Program Files (x86)\Java\jre1.8.0_161\bin\javaw.exe (18-Dec-2019, 12:23:58 AM)
[INFO] -----
[INFO] Building JavaComposerProject3 0.0.1-SNAPSHOT
[INFO] -----
[INFO] --- maven-clean-plugin:2.5:clean (default-clean) @ JavaComposerProject3 ---
[INFO] Deleting C:\testComposerProject11\MavenJavaComposerProject\target
[INFO] --- maven-resources-plugin:2.6:resources (default-resources) @ JavaComposerProject3 ---
[WARNING] Using platform encoding (UTF-8 actually) to copy filtered resources, i.e. build is platform dependent!
[INFO] skip non existing resourceDirectory C:\testComposerProject11\MavenJavaComposerProject\src\main\resources
[INFO] --- maven-compiler-plugin:3.1:compile (default-compile) @ JavaComposerProject3 ---
[INFO] No sources to compile
[INFO] --- maven-resources-plugin:2.6:resources (default-resources) @ JavaComposerProject3 ---
[WARNING] Using platform encoding (UTF-8 actually) to copy filtered resources, i.e. build is platform dependent!
[INFO] skip non existing resourceDirectory C:\testComposerProject11\MavenJavaComposerProject\src\main\resources
[INFO] --- maven-compiler-plugin:3.1:compile (default-compile) @ JavaComposerProject3 ---
[INFO] No sources to compile
[INFO] --- maven-resources-plugin:2.6:testResources (default-testResources) @ JavaComposerProject3 ---
[WARNING] Using platform encoding (UTF-8 actually) to copy filtered resources, i.e. build is platform dependent!
[INFO] skip non existing resourceDirectory C:\testComposerProject11\MavenJavaComposerProject\src\test\resources
[INFO] --- maven-compiler-plugin:3.1:testCompile (default-testCompile) @ JavaComposerProject3 ---
[INFO] No sources to compile
[INFO] --- maven-surefire-plugin:2.12.4:test (default-test) @ JavaComposerProject3 ---
[INFO] No tests to run.
[INFO] --- maven-jar-plugin:2.4:jar (default-jar) @ JavaComposerProject3 ---
[WARNING] JAR will be empty - no content was marked for inclusion!
[INFO] Building jar: C:\testComposerProject11\MavenJavaComposerProject\target\JavaComposerProject3-0.0.1-SNAPSHOT.jar
[INFO] -----
[INFO] BUILD SUCCESS
[INFO] -----
[INFO] Total time: 1.473 s

```

Important

A Maven project augments the capability of Composer to build (or compile) the Java and Composer sources (VXML & SCXML) seamlessly. With this support, users can directly consume or access Composer's backend APIs (`composerBackend.jar`) in their Java counterparts (`src/main/java`).

WebSphere Application Server Files

The custom **Build.xml** and Maven **Pom.xml** files will not create the **ibm-web-bnd.xmi** and **jboss-web.xml** WebSphere Application Server files, respectively. Users must create these files manually and place it under the project's WEB-INF directory. Once created, the files are updated automatically.

Sample **ibm-web-bnd.xmi** file:

```

<?xml version="1.0" encoding="UTF-8"?>
<webappbnd:WebAppBinding xmi:version="2.0" xmlns:xmi="http://www.omg.org/XMI"
xmlns:webappbnd="webappbnd.xmi" xmi:id="WebAppBinding_1276009185886"
virtualHostName="default_host">

```

```
<webapp href="WEB-INF/web.xml#WebApp_ID"/>
<resRefBindings xmi:id="ResourceRefBinding_1276009394684" jndiName="jdbc/pooledDS">
<bindingResourceRef href="WEB-INF/web.xml#ResourceRef_1276009394684"/>
</resRefBindings>
</webappbnd:WebAppBinding>
```

Sample *jboss-web.xml* file:

```
<?xml version="1.0" encoding="UTF-8"?>
<jboss-web>
  <resource-ref>
    <res-ref-name>jdbc/oraclePooled</res-ref-name>
    <res-type>javax.sql.DataSource</res-type>
    <jndi-name>java:comp/env/jdbc/oraclePooled</jndi-name>
  </resource-ref>
</jboss-web>
```

Important

The generic WAR Export wizard generates these files only during WAR export. In other instances, users must create these files manually.

Voice Application Project Types

Voice applications are VoiceXML applications with full support for the Genesys Voice Platform. A Voice application can be deployed on a web application server that meets the minimum prerequisites described in the [Composer 8.1 Deployment Guide](#). Also see [Creating Voice Applications for GVP](#).

Routing Application Project Types

Routing applications are SCXML applications with full support for the modules described in the [Orchestration Developer's Guide](#). A Routing application can be deployed on a web application server meeting the minimum prerequisites described in the [Composer 8.1 Deployment Guide](#). Also see [Creating a New Routing Project](#).

Project Structure/Directories

A Composer Project (Java or .NET) will contain some or all of these subfolders depending on the type of Project:

- App_Code -- .NET Composer Projects only. This folder will be empty by default as Composer bundles all the C# classes in to the ComposerBackend.dll file. Custom C# classes will also go into this folder.
- bin -- Any libraries used in a .NET Composer Project go here.

- Callflows -- Folder for storing all the callflow diagrams (.callflow files)
- db -- **Database connection.properties** and .sql files are stored here.
- include -- Composer-provided standard include files used by **Backend** logic blocks.
- debugging-results -- The **Run As** option on a VXML file creates a debugging-results folder when no debugging-results folder exists in the Project.

Custom JavaScript files (.js) can be included in a routing application by placing the file(s) in the include/user folder. Re-generating code for all IPD diagrams in the project is required after placing the files. The JavaScript functions in the specified .js file can then be used from any Workflow block that supports writing expressions e.g. the Assign, Branching and ECMAScript blocks.

- META-INF -- Created when you create a new Java Composer Project. It is needed for Java and is included when a .war file is exported from Composer. Do not make changes to this directory.
- WEB-INF/lib -- Java Composer Projects only. Folder for external dependency libraries such as JAR files. Note: The Tomcat application server should be restarted after changing any JAR files in this folder.
- Interaction Processes -- Folder for storing all the **interaction process diagrams** (.ixnprocess files).
- Resources -- Folder for the audio and grammar resources. Resources/grammars -- Folder for **Grammar Builder** (.gbuilder files) and GrXML files.
 - Resources/grammars/<language code> -- Place language-specific grammars here (such as en-US or es-MX folders).
 - Resources/prompts -- Folder for prompts files.
 - Resources/prompts/<language code> -- Place language-specific prompts here. If the application language is changed mid-call using a Set Language block, prompts audio resource paths in these language folders will be translated to the current language at run time.
- Scripts -- Folder for user-written ECMAScript. Custom JavaScript files (.js) can be included in a voice application by placing the file(s) in the Scripts folder.
- src-gen -- Folder for the code generation VXML/SCXML files.
- upgradeReports -- When **migrating IRD strategies into Composer**, folder for migration reports. Also used for reports as result of **upgrading Projects and diagrams**.
- src -- Folder for custom code such as backend logic pages written by the user. The **ComposerPlayTreatments** VXML file is located here.
- Workflows -- Folder for storing all the workflow diagrams (.workflow files).

Static VXML/SCXML code is generated with the name of the Composer diagram file. The code will be saved in the src-gen folder under the current active Project. The two types of Projects have different Project natures. Based on these Project natures, different builders, editors and preferences are associated with the Projects. For example, .NET Composer Projects and Java Composer Projects have different preferences for deployment since they are deployed to different web/application servers.

Project Folders and Resources

Common Project folders and resources (Resources, src, include, db, and so on) do not change between .NET and Java Projects. Project Export and deployment procedures related resources will differ between .NET and Java Projects (bin folder for .NET and WEB-INF, META-INF folders for Java).

For more information, see [Migrating a Composer Application From Lab to Production](#).

Sub-Directories

Composer 8.1.440.18 adds support for sub-directories:

Feature	Scope	Comments
Generate All	Project	Instead of selecting direct files from the diagram folders, Generate All now includes all the folders and files recursively.
Locales Project property	Project	Used to update Project locales. Now includes all the folders and files recursively.
Command Line Code Generation	Project	Used to generate code for all the diagrams. Now includes all the folders and files recursively.
Command Line Upgrade	Project	Used to upgrade callflow, workflow, and IPD diagram files. Now includes all the folders and files recursively.
Command Line Publish	Project	Used to publish all IPD files. Now includes all the folders and files recursively.
Java Project Export	Project	Used to generate code while exporting WAR files. Now includes all the folders and files recursively.
Debugger	Diagram	Includes all the folders and files recursively for code generation during debugging.
Project Upgrade	Project	Used to upgrade callflow, workflow, and IPD diagram files. Now includes all the folders and files recursively.
SubModule handling	Diagram	Used to find the sub-module diagram when using auto-synchronization of parameters.
New callflow/workflow file creation	Project	Allows you to create new callflow/workflow files under the selected sub-directories (right-click and New > Other > Composer > Diagrams). Previously, it was created only under the callflows or workflows directory.

Folders Created When Upgrading Projects and Diagrams

The following additional folders may also be created in the Project Explorer:

- When upgrading to 8.1, a Project upgrade creates the folder `./WEB-INF/lib`, copies files from `./lib` to `./WEB-INF/lib`, then removes the `./lib` folder from the Java Composer Project.
- `archive --` For placing zipped original contents of the Composer Project (created during an upgrade).
- `upgradeReports --` For upgrade reports (created during an upgrade).

Adding Files to an Existing Project

Composer recommends adding files (i.e., a prompts audio file) to an existing Project within Composer using the following methods:

- Use the **File > Import** capability.
- Add directly from Windows Explorer and then refresh the resource list by pressing F5 in Composer's Project Explorer.
- Drag and drop files onto Composer's Project Explorer.

For out of sync files, please see troubleshooting topic [Workspace Files Not in Sync](#).

Project Permissions

Composer Project upgrade and code generation processes need current\launching user WRITE permission to the Composer Project Directories and Files. If you move Projects between Windows and OS X, these considerations may apply:

WRITE permission:

In Windows 7 OS, Projects created using Mac OS needs Effective Permission to be set. To do that:

1. Open Windows Explorer and browse to Composer Project directory.
2. Right Click the Project folder and select the **Properties** option to open the properties dialog.
3. Select the **Security** tab and click the **Advanced** button.
4. In the Advanced properties dialog, select the **Effective Permissions** tab.
5. In the Effective Permissions tab, select the current User / Groups to grant Full Permission.

Also uncheck the **Read-only** and **Hidden** properties in the **General** tab for the Project and sub directories. Note: While importing Composer Projects, if the **Copy Projects into Workspace** option is selected, the above mentioned permissions needs to be set for the copied Project directory separately.

Using Composer Shared Subroutines

Typically subroutines are a part of the Project in which other diagrams call them. This makes the project self-contained that can be deployed as a unit with minimum dependencies on other Projects. However, in some cases subroutines may be used by multiple Projects but are required to be present in only one location in the workspace. This need for residing in a single Project within the workspace is usually governed by the need to deploy to all subroutines to a single location from where these subroutines may be referenced by multiple applications - similar to how a service is exposed. It is recommended that subroutines be a part of the Project they are consumed in and to enable this "sharing" via an SCM system (e.g., symbolic links in ClearCase; other system will support this capability differently). If that is not an option, subroutines in Composer can be placed into a "common" Project, so that multiple other Projects can access and reuse them. NOTE: In order to support the URL substitution from the "\$\$" tokens, this feature requires Orchestration Server version 8.1.300.27 and above.

In our example, we will create two Projects:

- CommonProject - the Project containing subroutines
- MainProject - the Project containing the main diagrams, which will use the subroutines in CommonProject

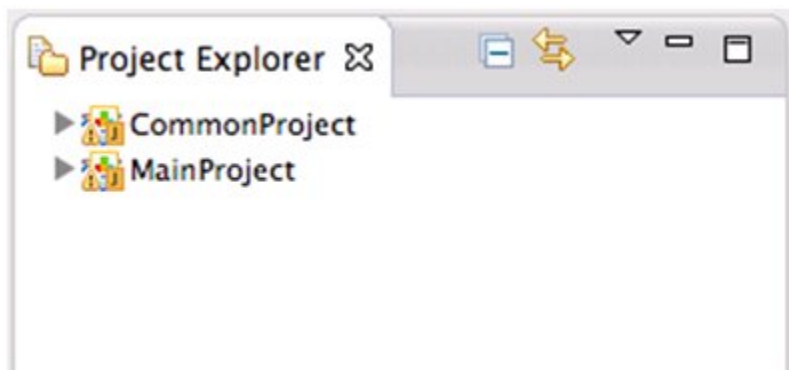

After subroutines have been created in CommonProject, MainProject must be set to reference CommonProject. This means that MainProject can use the subroutines files in CommonProject.

To do this, open the Project properties page of MainProject by right-clicking and selecting **Properties**. Select the **Project References** page on the left-hand side, and enable the checkbox for **CommonProject**:

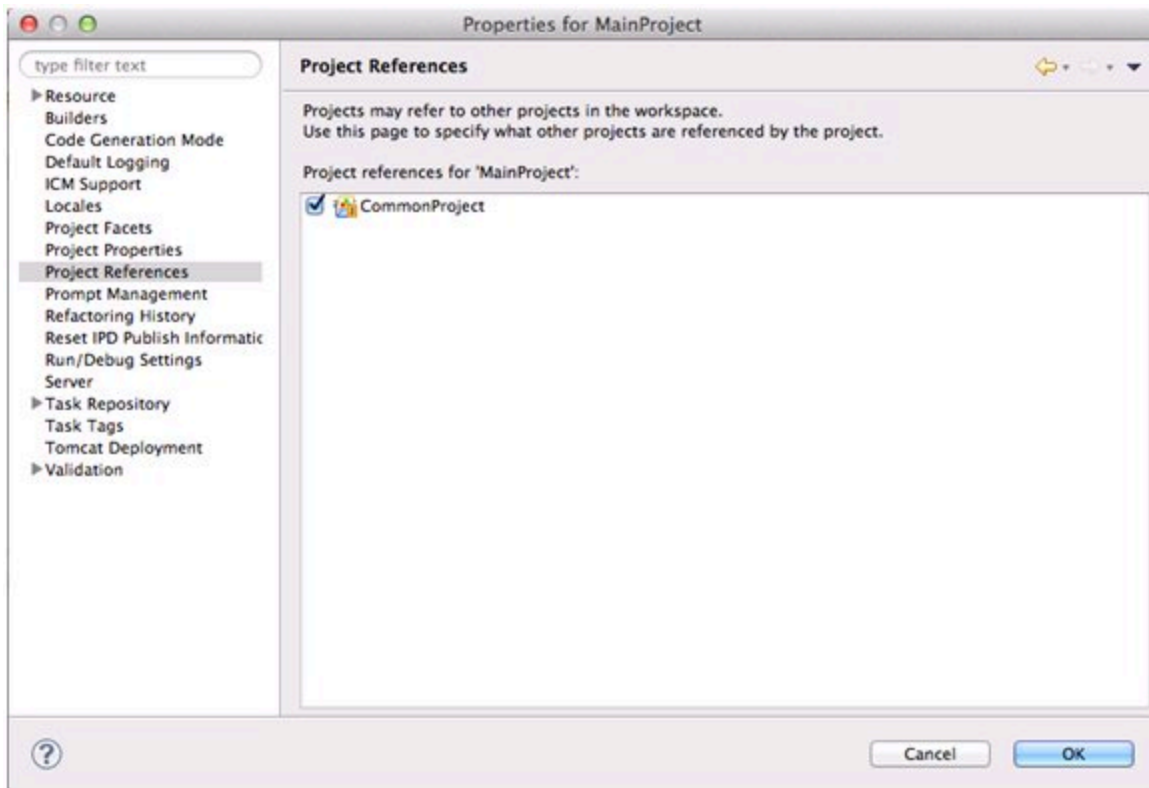

In a callflow in MainProject, you can create a **Subdialog block** which uses a Subcallflow diagram in CommonProject:

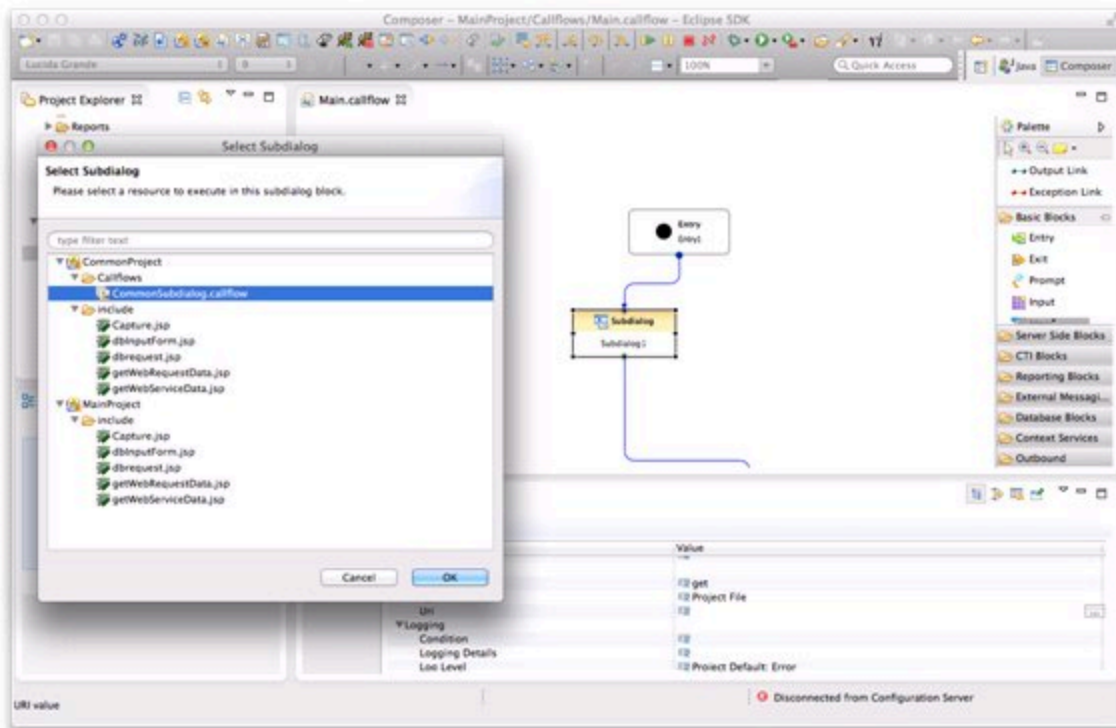

Debug and Release Modes

When using shared subroutines, it may be helpful to separate the development process from the final deployed application. During the development process, it is assumed that `CommonProject` resides in the same Workspace as `MainProject`. However, in a production environment, a more complex service may be needed to host subroutines.

Composer supports the concept of *Debug* and *Release* mode code generation. Using this mode flag, the same Project can generate different code suitable for specific tasks.

Debug and Release mode can be set by Project properties dialog:

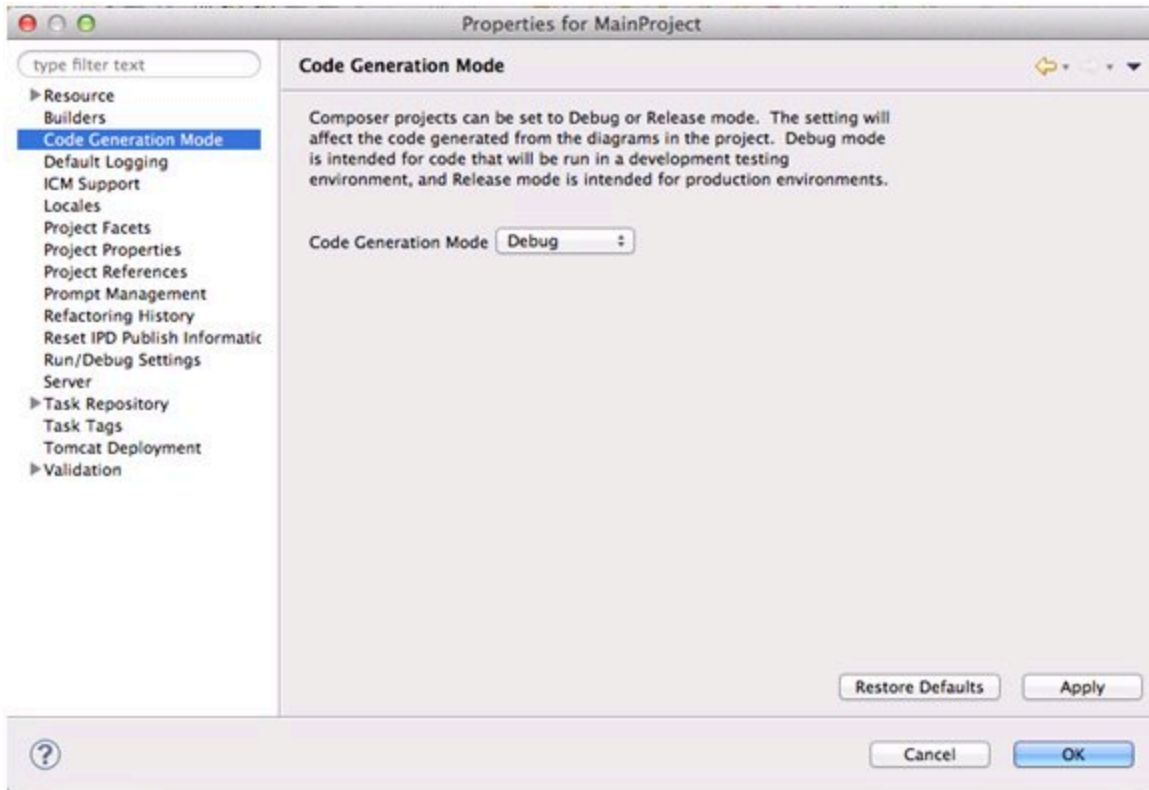

To apply **Release Mode** to shared subroutines development, open the Properties view of the Subdialog block in the the callflow for MainProject. Enable the **Show Advanced Properties** option:

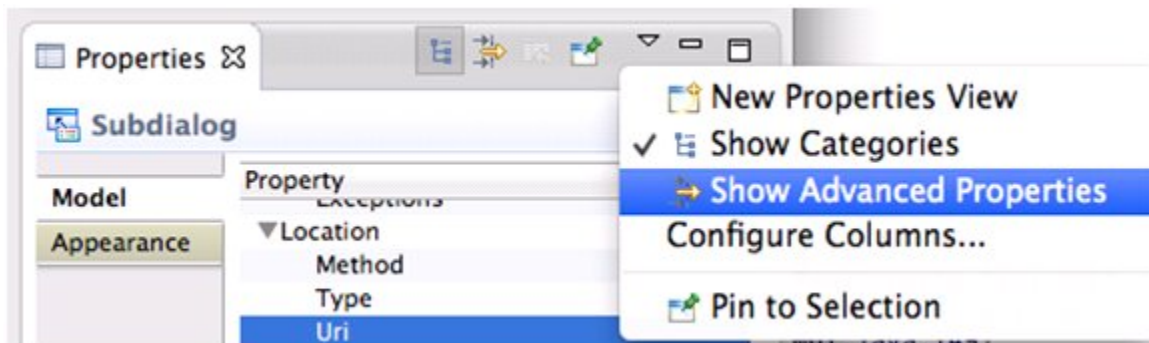

This will reveal a **Release Mode URI** property:

Location	Method
Release Mode Uri	get
Type	Project File
Uri	http://\$\$SUBROUTINE_SERVICES\$/subroutines/\$\$SUBROUTINE_VERSION\$\$

Note that any token delimited by “\$\$” in this property can be substituted at runtime.

Once the Application is ready to deploy, set the **Code Generate Mode** of the Project to **Release**.

This will generate code that uses the **Release Mode URI** property value.

Project Properties

Selecting Properties from the Project menu opens a dialog box showing the **properties** of the selected Project or of the Project that contains the selected resource.

Project Properties

Right-click a Project and select **Properties** to bring up a dialog box where you can view/update various Project properties. This topic describes the various Project Properties pages. For more help on each property, select the property and press F1. A help view appears on the right.

Resource

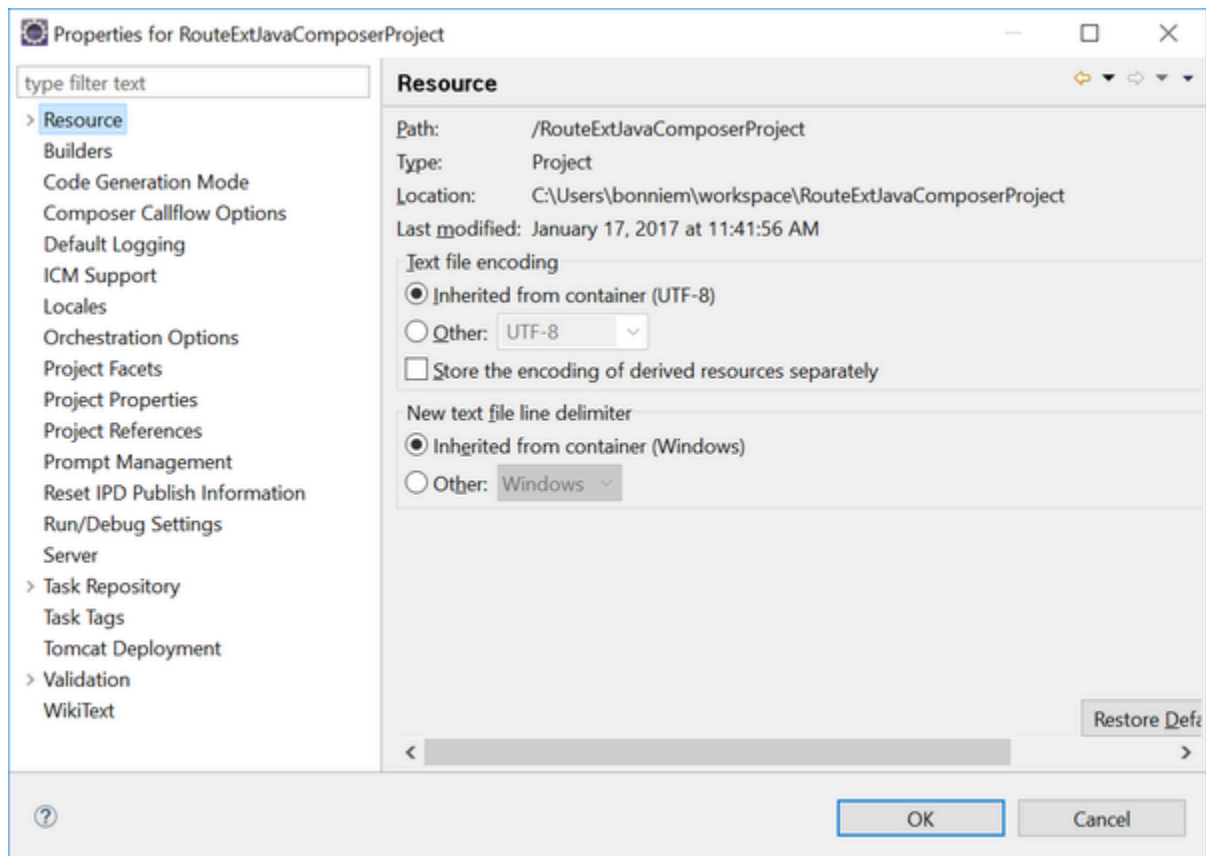

The Resource page contains general information on the selected **Project**. For information on UTF-8, see the [VXML File Preferences](#) topic.

Builders

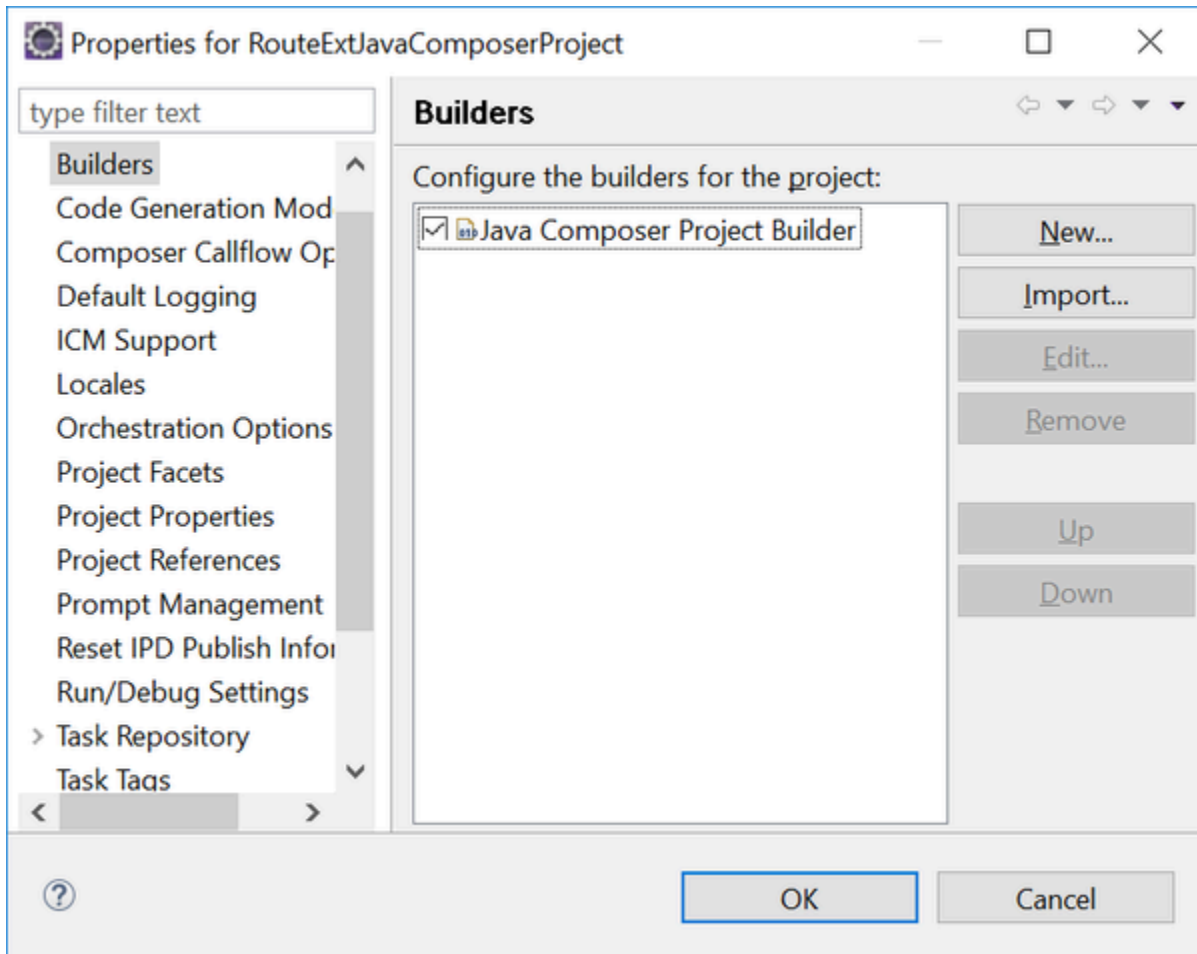

The Builders page indicates the **Project** type, It indicates whether the Project is a Java Composer Project, a .NET Composer Project, or another type of Project.

Code Generation Mode

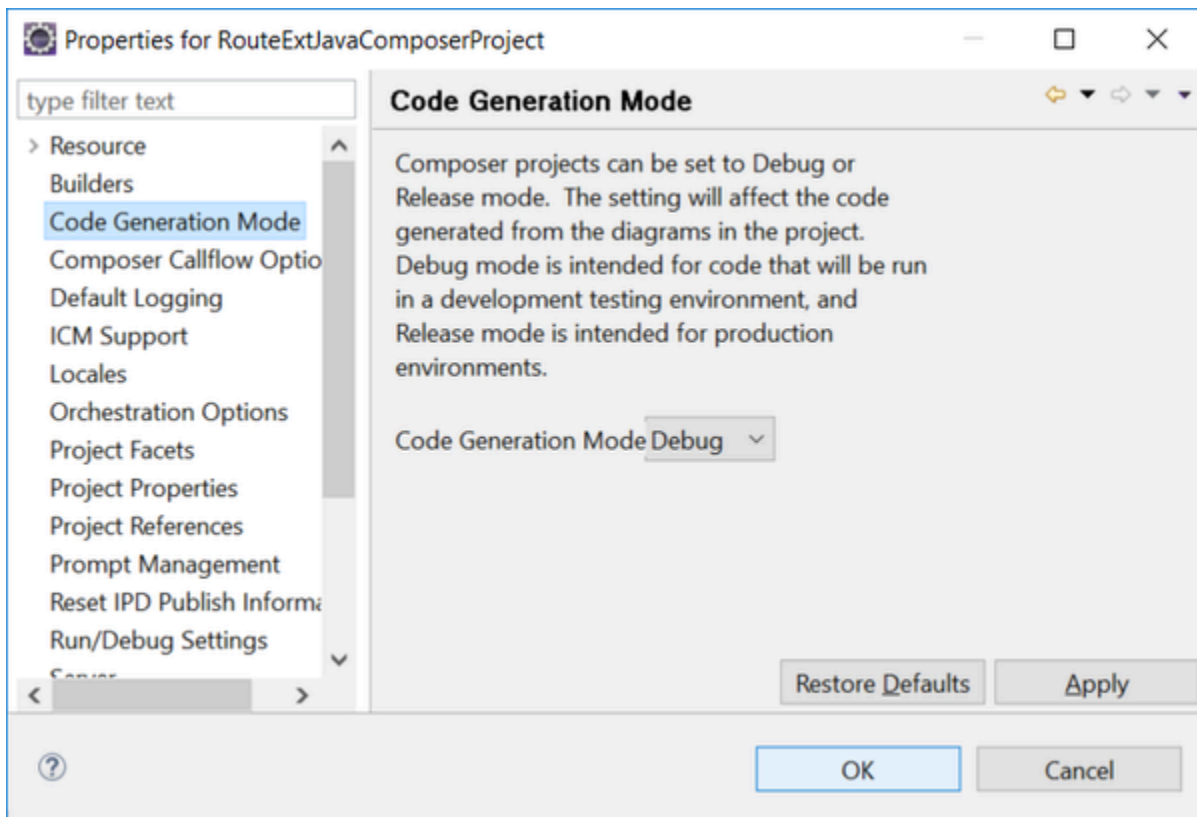

Used to determine whether a Project will be used in a production or development environment. See the [Debug and Release Modes](#) topic.

Composer Callflow Options

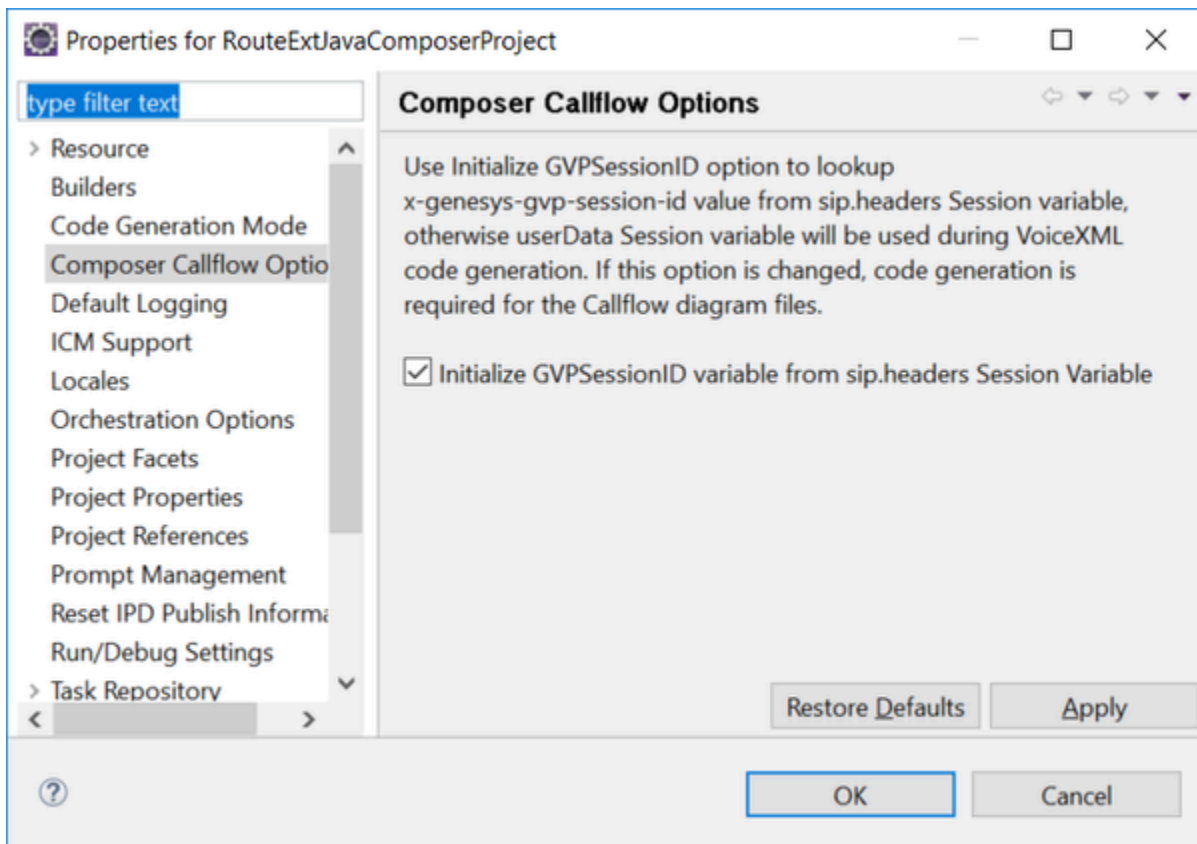

See the [GVP SessionID System Variable](#) topic.

ICM Support

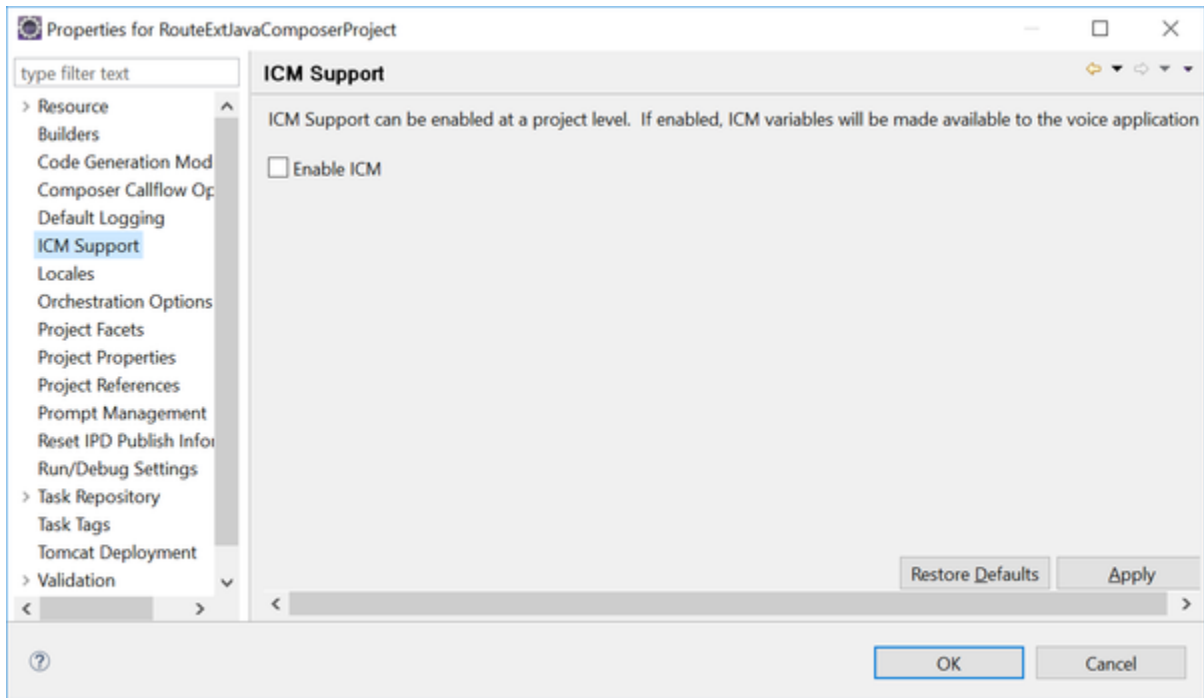

See the [ICM Interaction Data Block](#) topic.

Default Logging

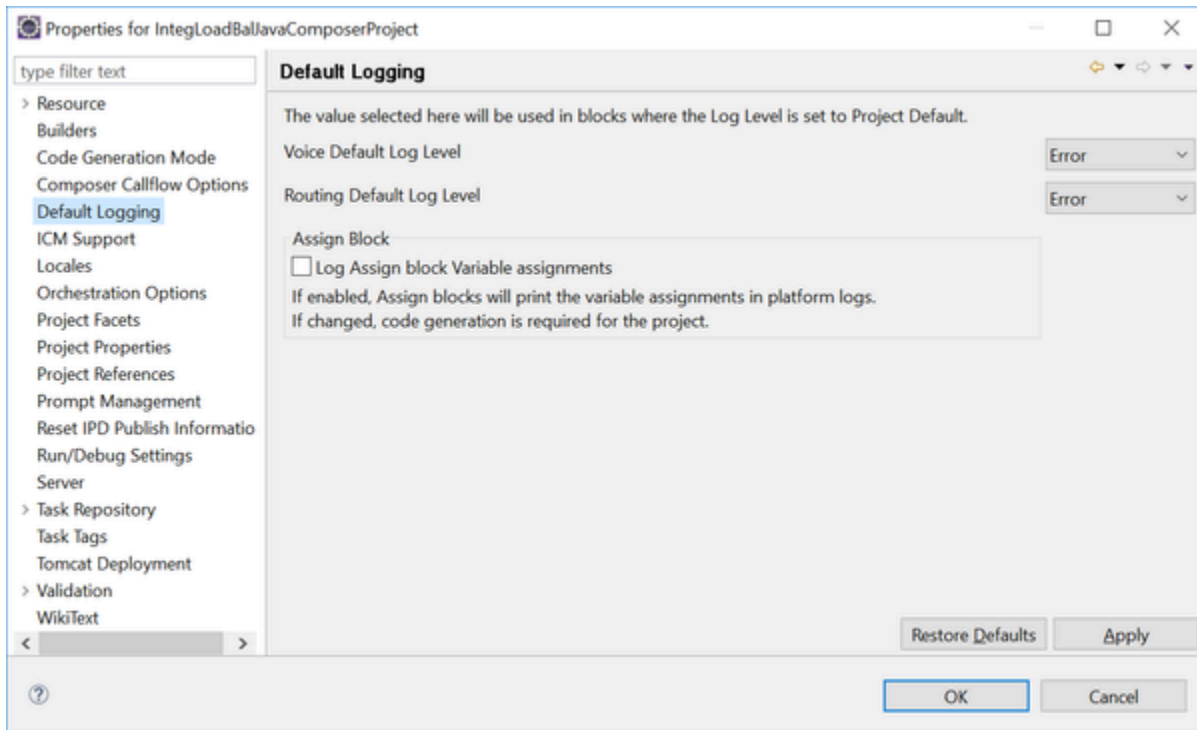

See the [Assign Common Block](#) topic.

Locales

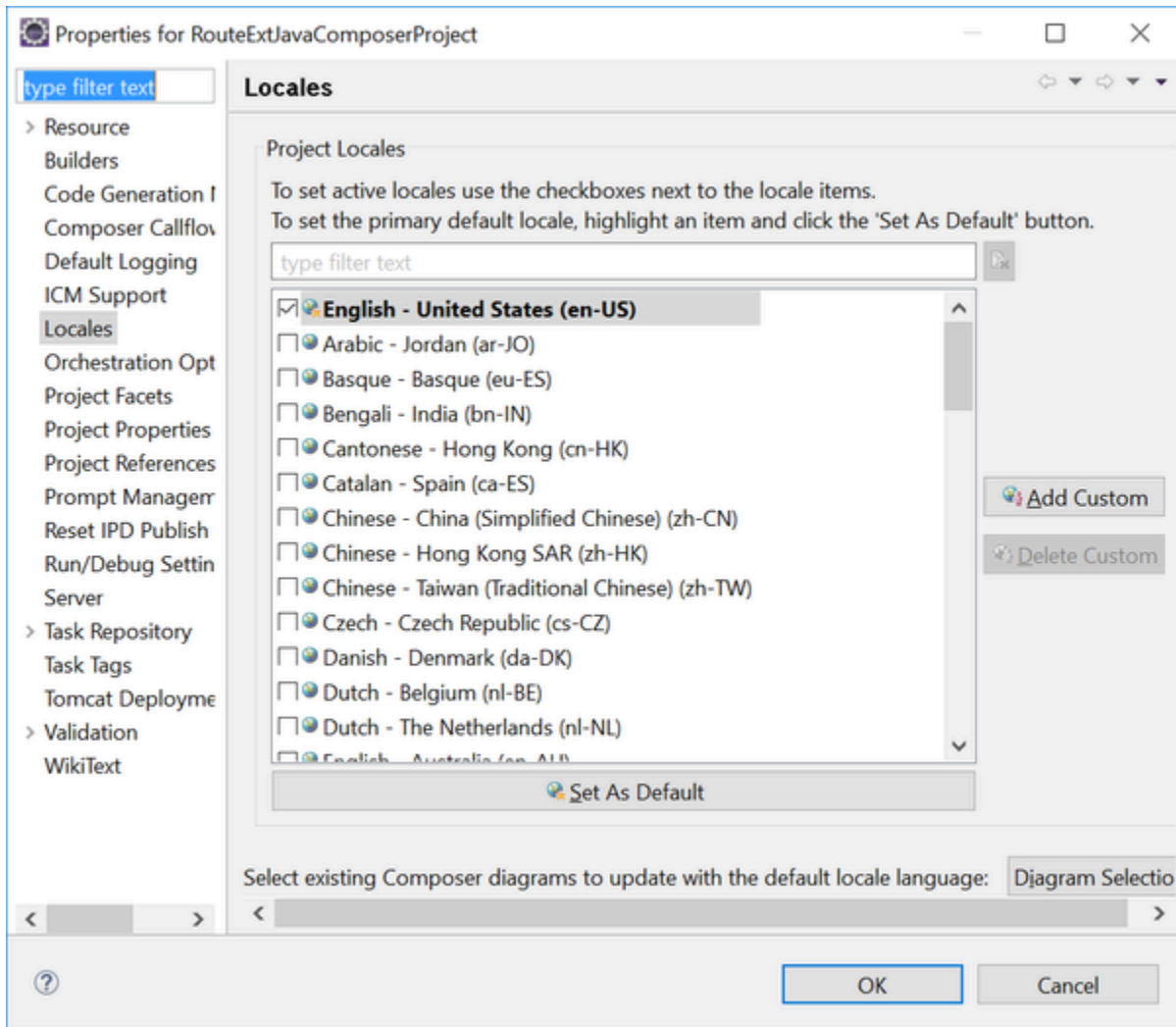

See the [Locales](#) topic.

Orchestration Options

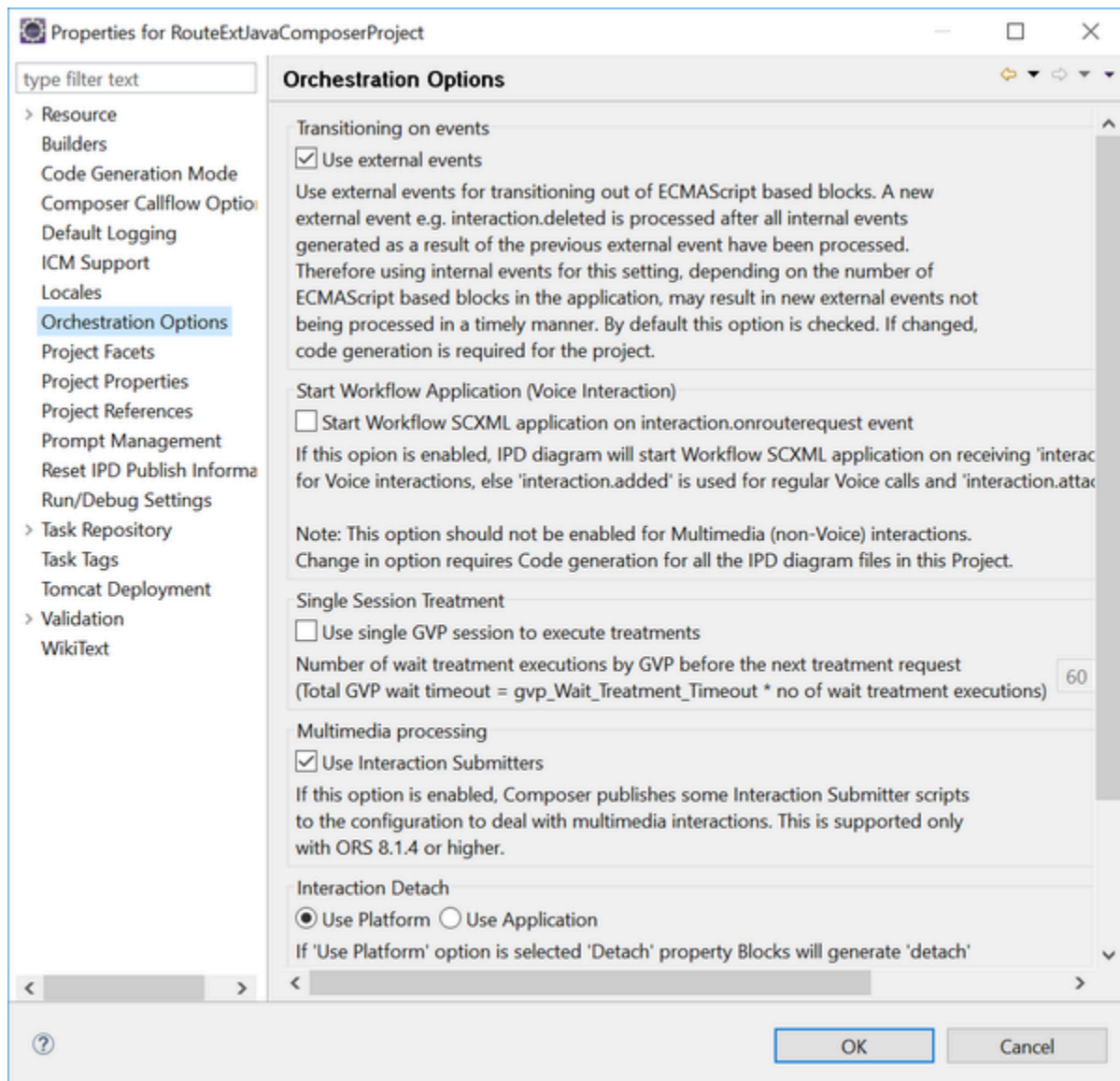

See the

[Orchestration Options](#) topic.

Project Facets

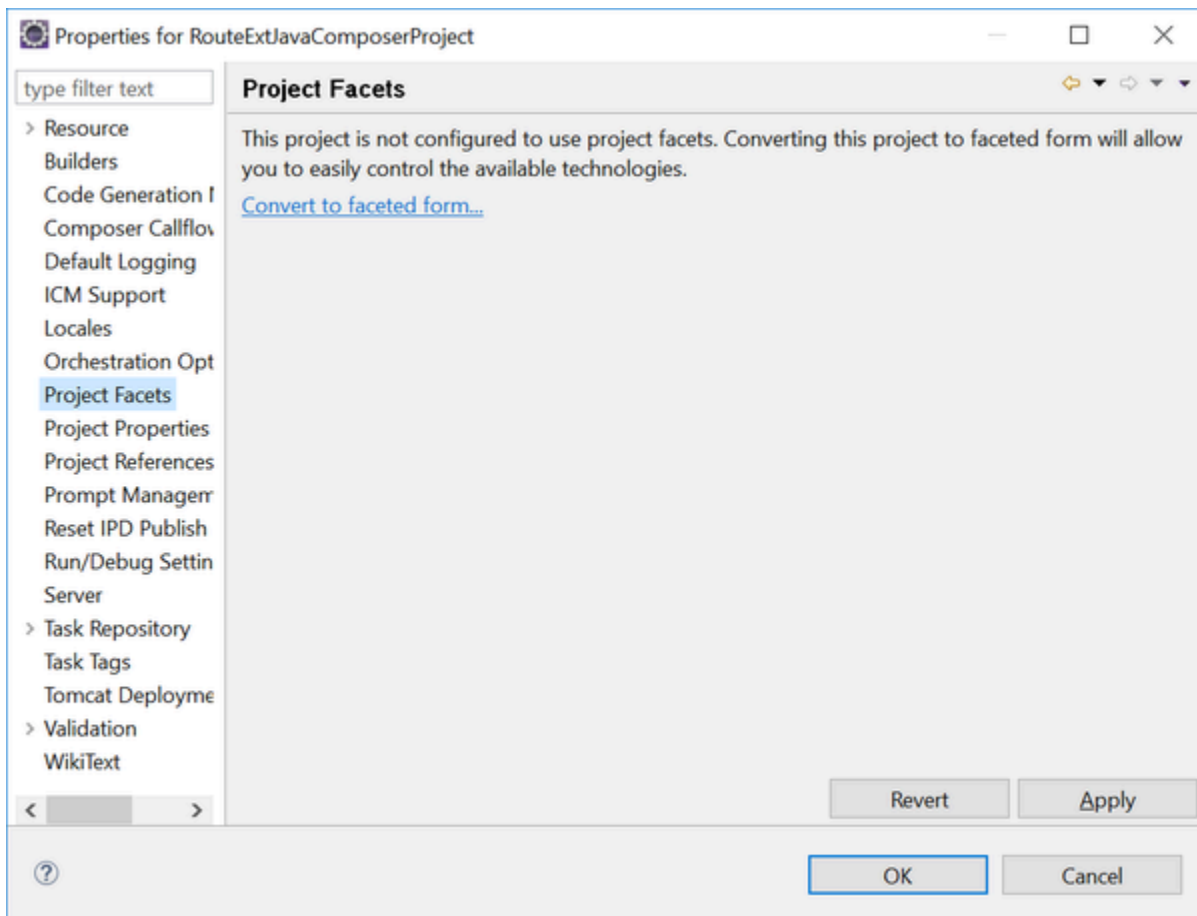

Project Properties

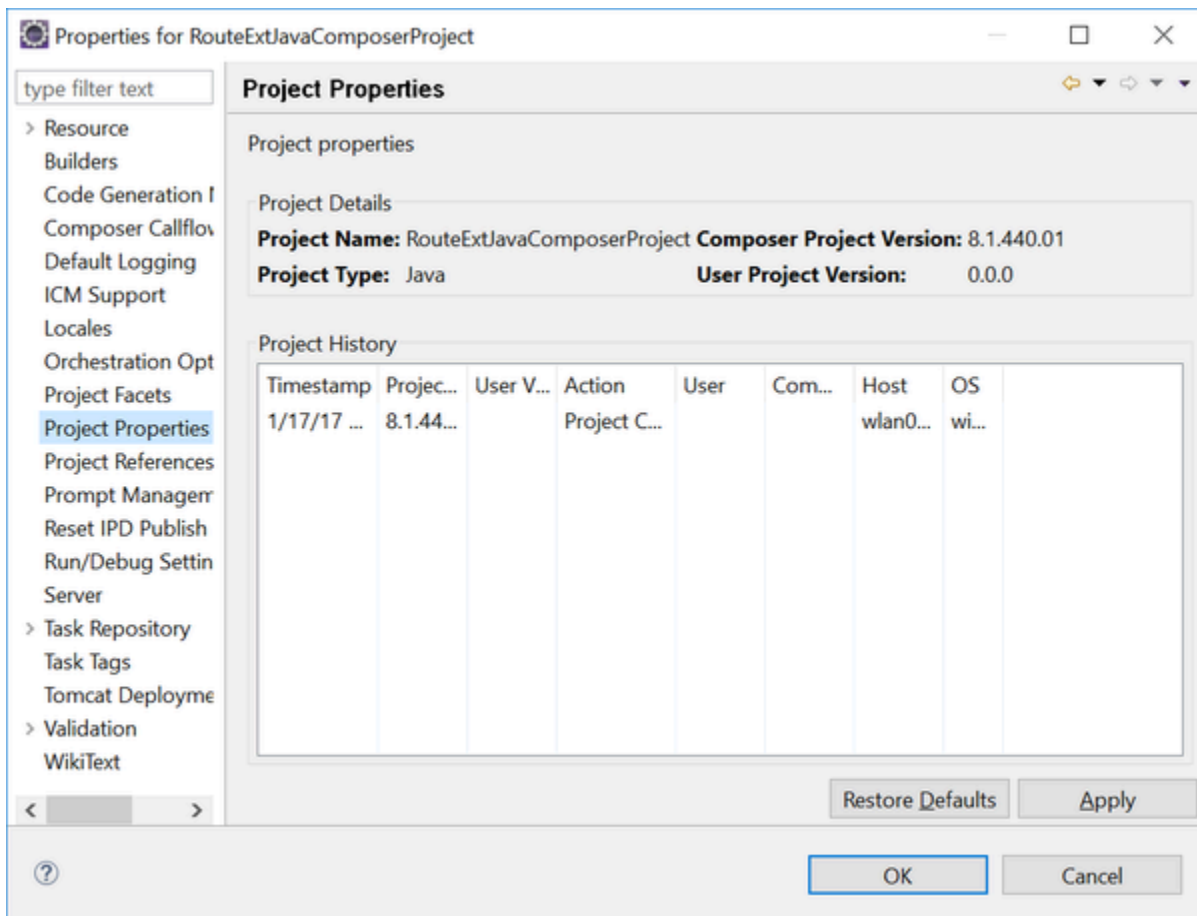

See the Project Properties section of the [Project Menu](#) topic.

Project References

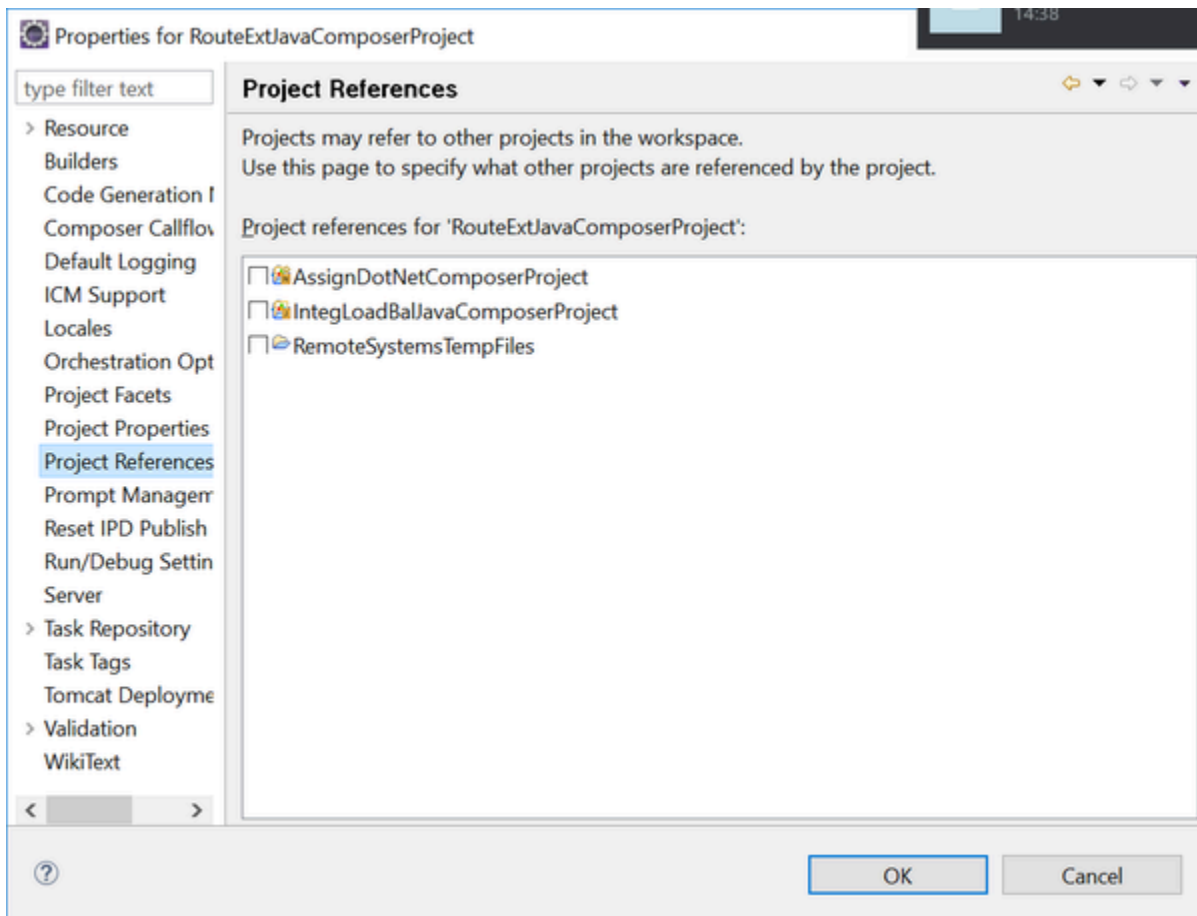

Use when a Project refers to other Projects in the [workspace](#).

Prompt Management

Use this dialog box to configure the recording of prompts and to enable dynamic prompts.

Recording Prompts

See the [Recording Prompts](#) topic.

Enabling Dynamic Prompts

Starting with 8.1.440.18, Composer provides support to optionally include dynamic prompts supporting JavaScript files in the generated VoiceXML. Use the **Enable Dynamic Prompts** property in the Prompt Management page to enable or disable dynamic prompts. If enabled (default), use of

dynamic prompt options in the Prompt or other blocks will be validated during code generation. If disabled, callflow diagram code generation will exclude the Javascript files related to the dynamic and custom Prompts (including locale JavaScript files).

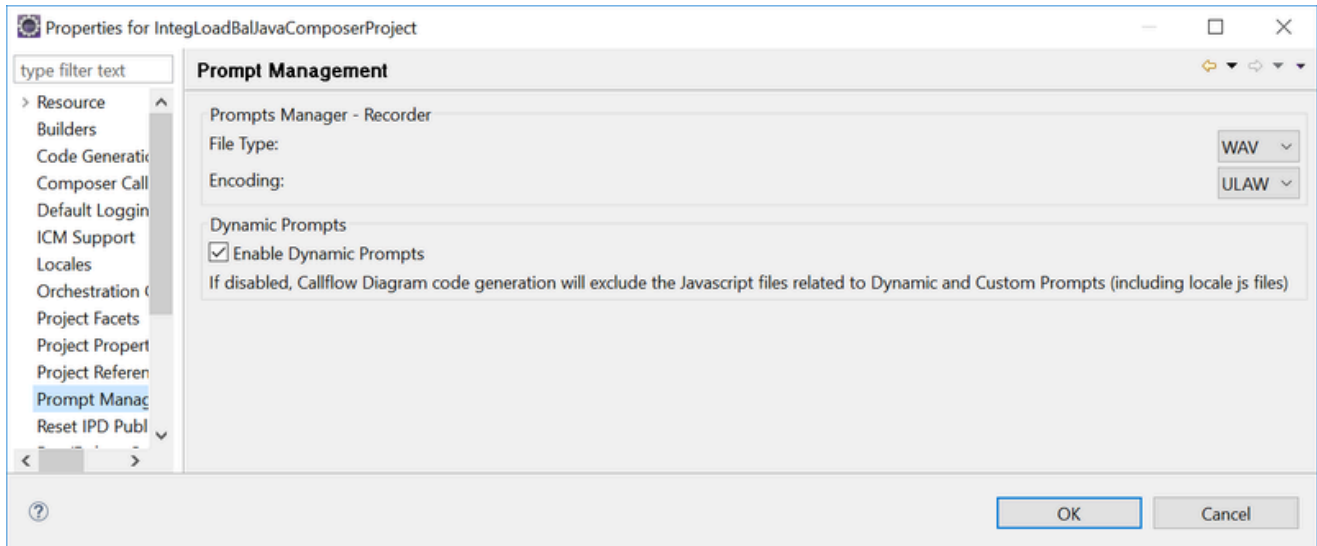

For information on dynamic prompts, see:

- [GVP 8.1 VoiceXML Help](#)
- [GVP 8.1 Legacy Genesys VoiceXML 2.1 Reference Manual](#)

Reset IPD Publish Information

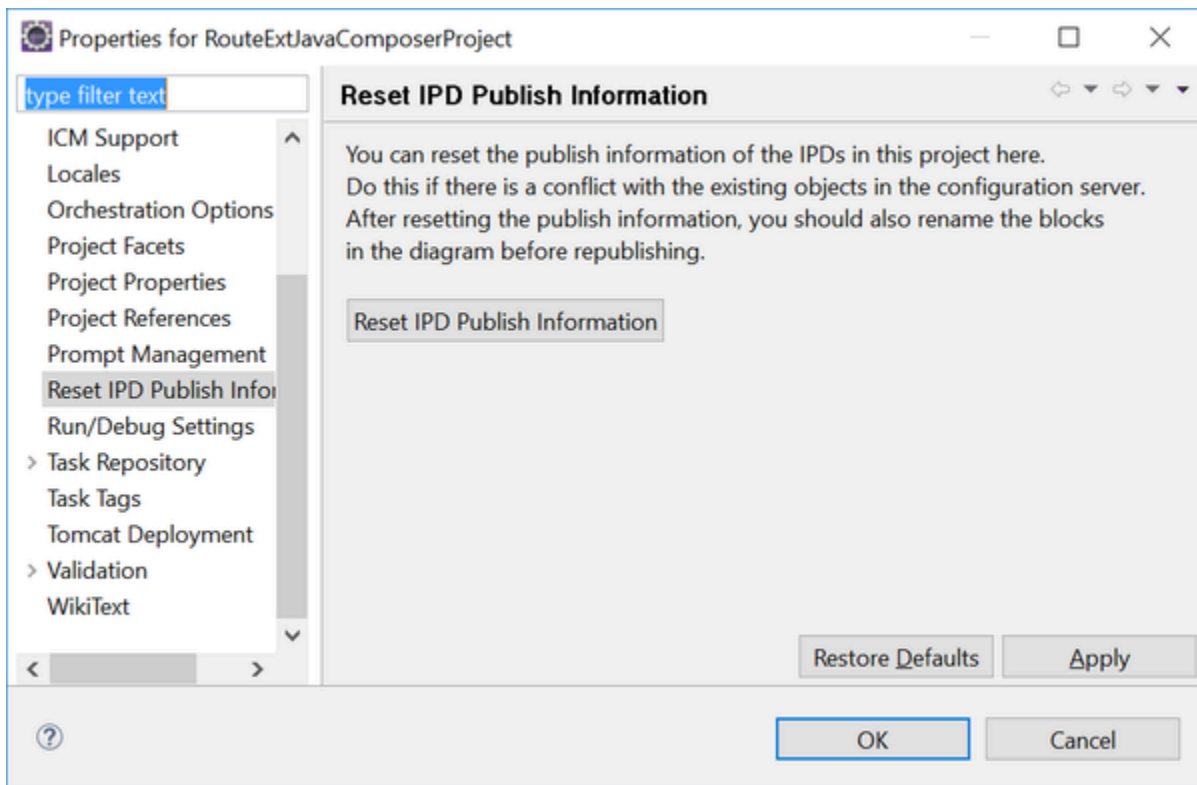

See the [Publishing Updates](#) topic.

Run Debug Settings

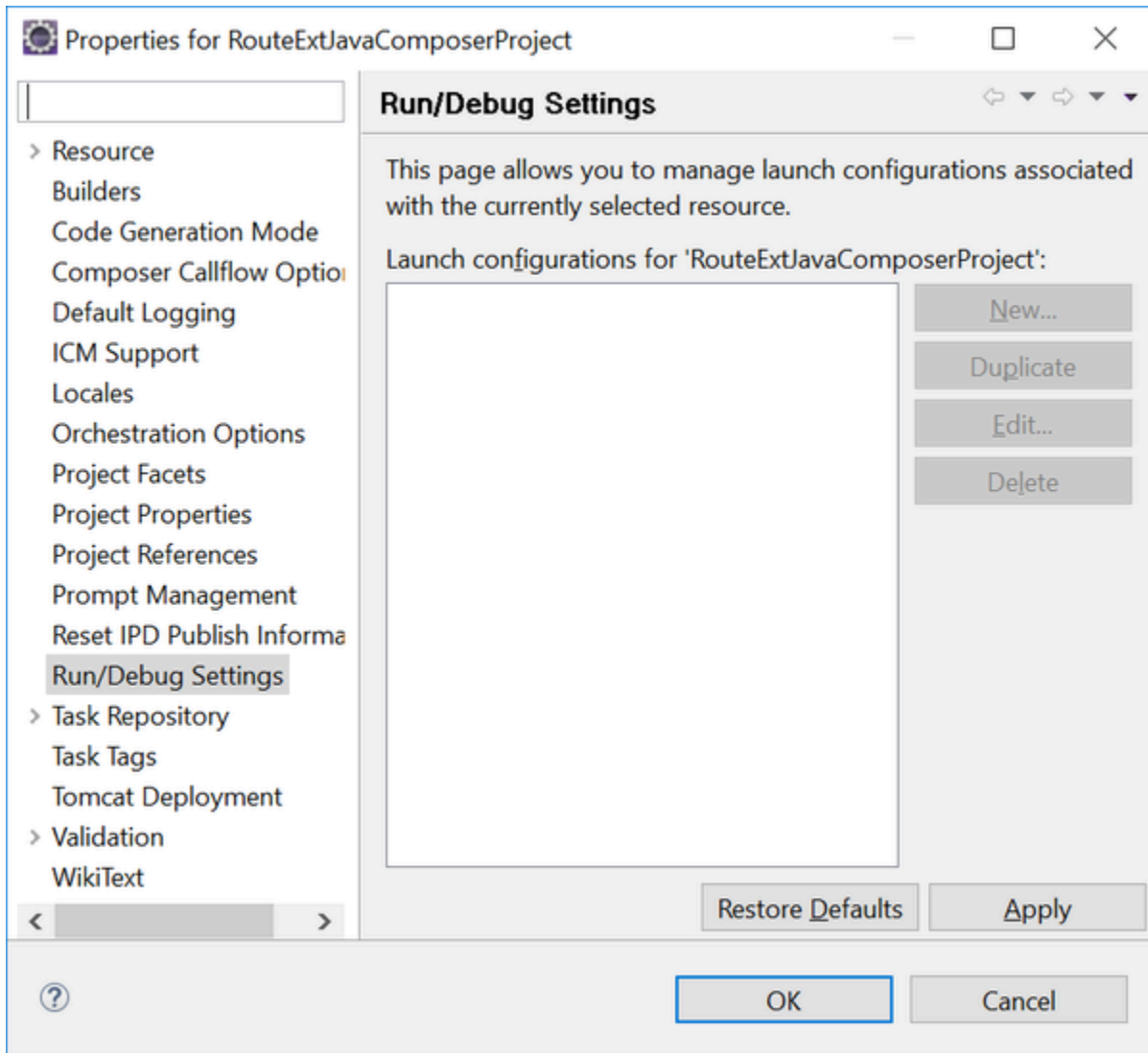

See the [Debugging Routing Applications](#) topic.

Task Repository

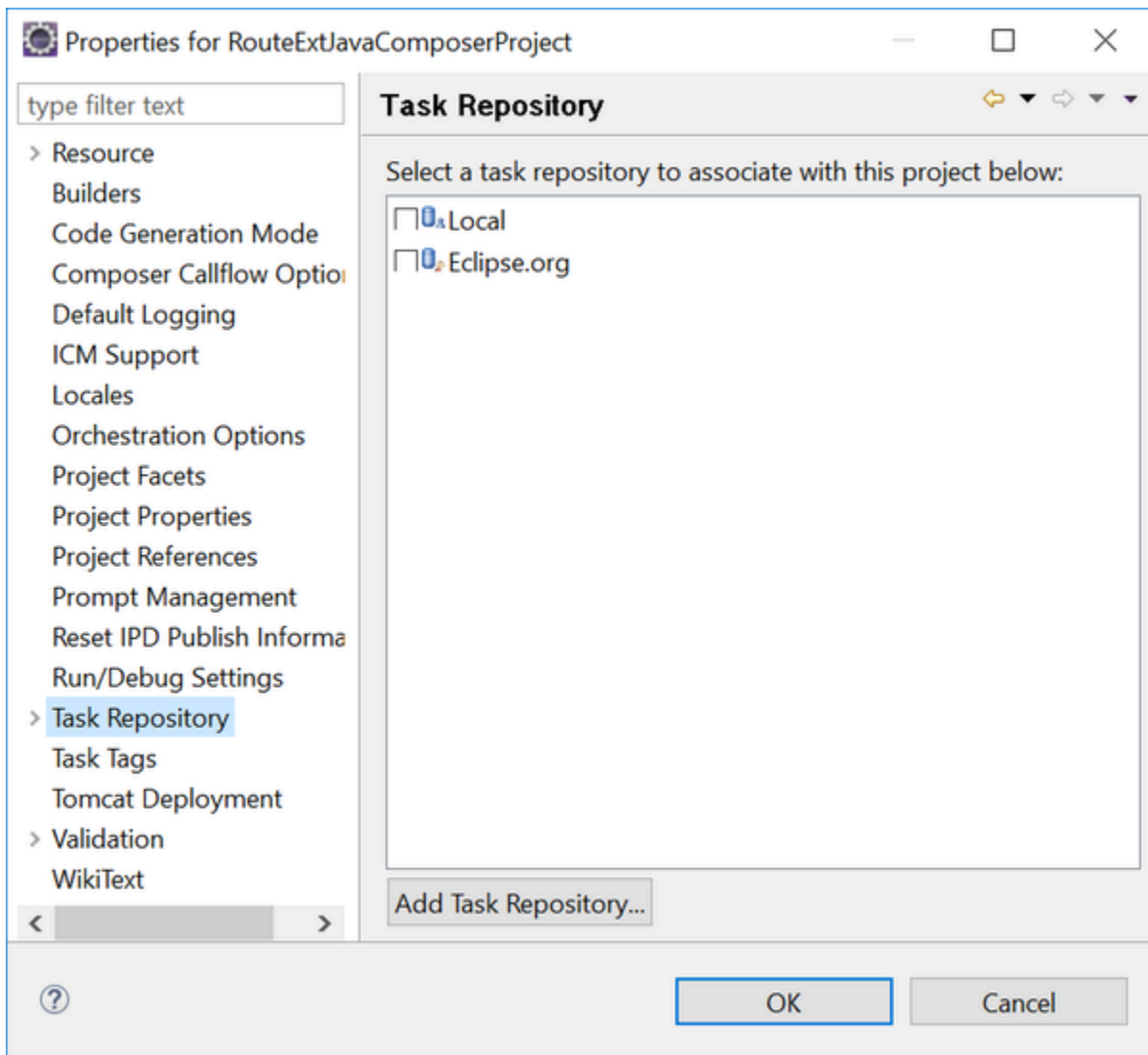

Task Tags

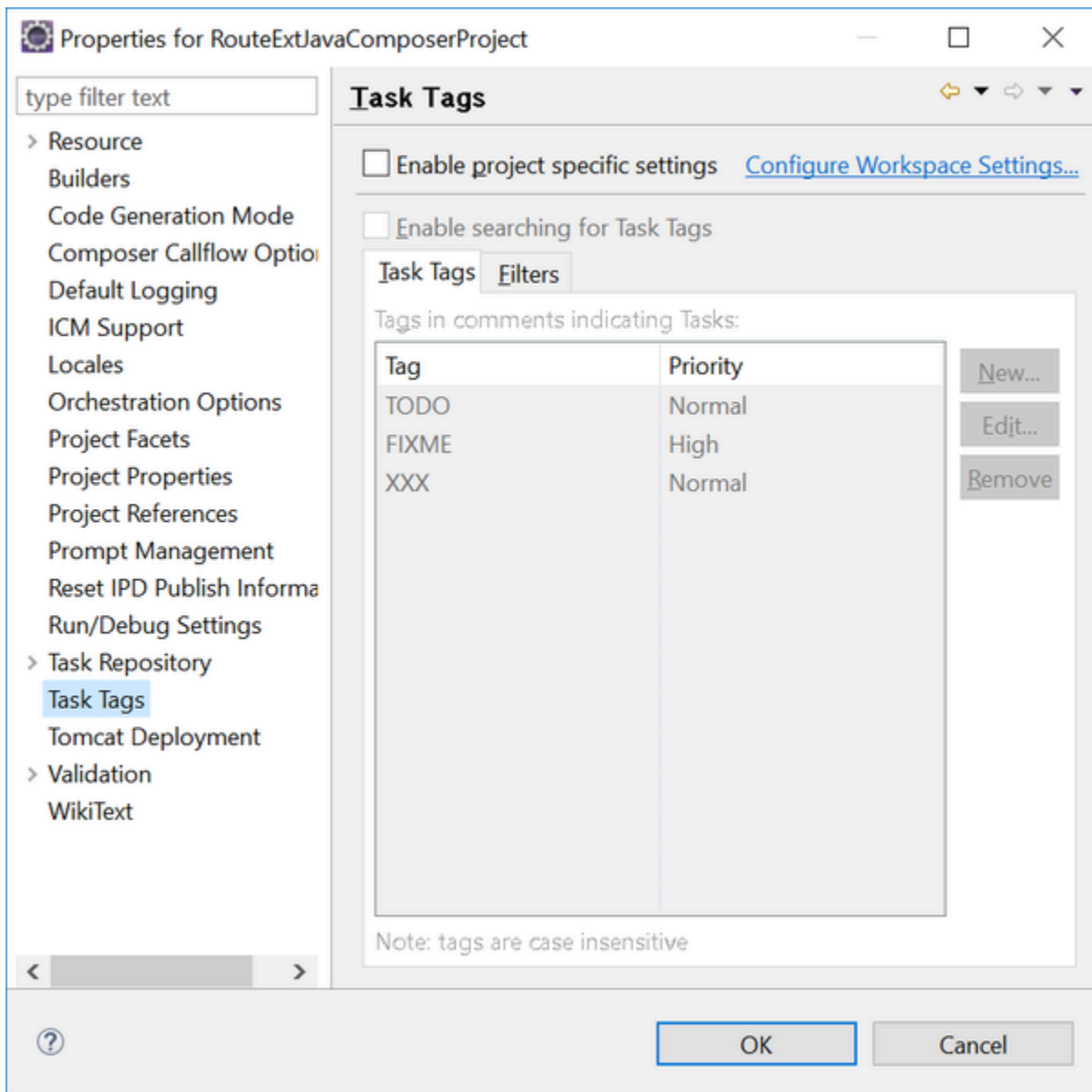

Use to specify or add a Task Repository.

Tomcat Deployment

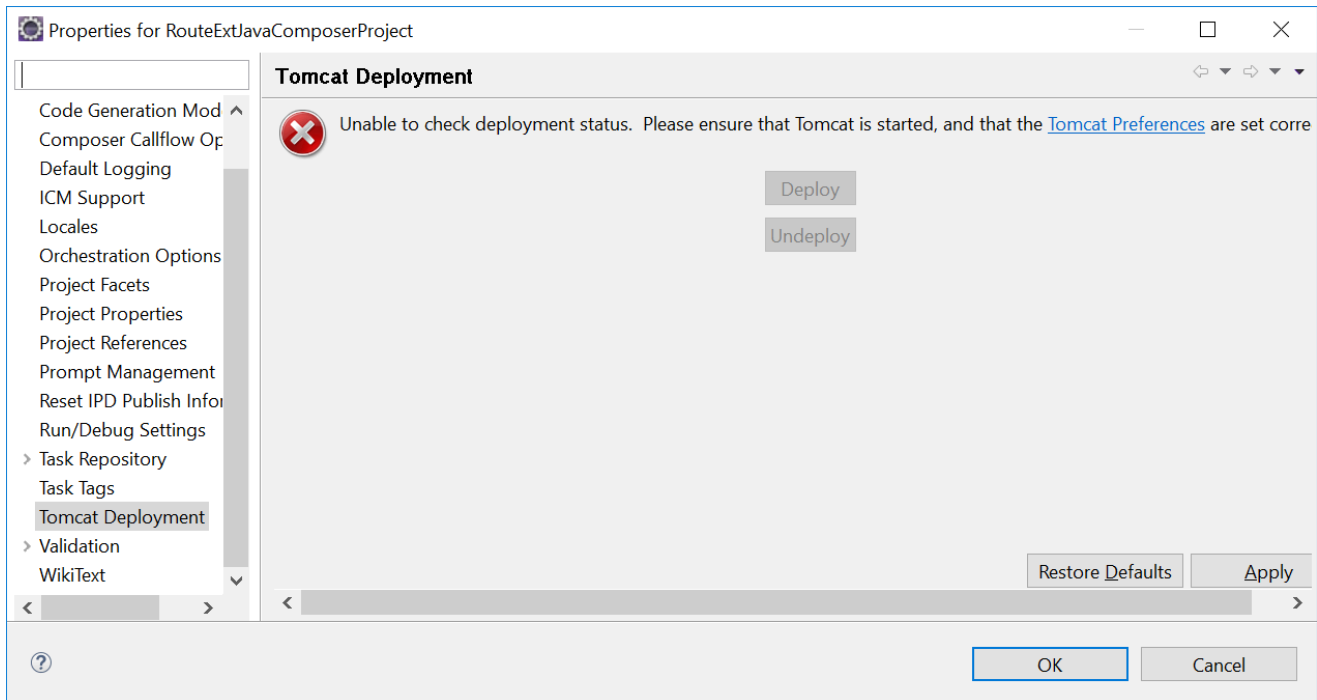

See the [Testing your Application](#) topic.

Validation

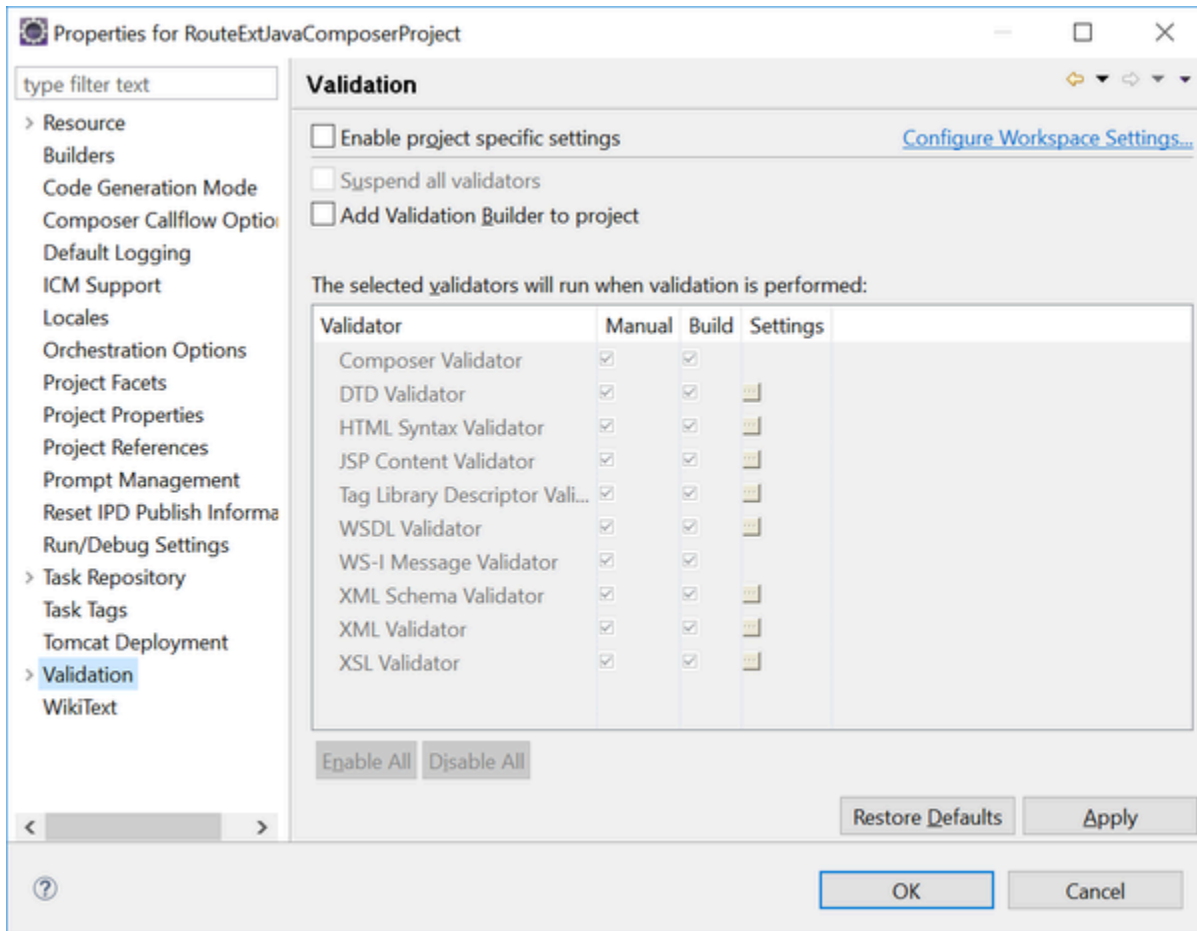

See the [Validation](#) topic.

WikiText

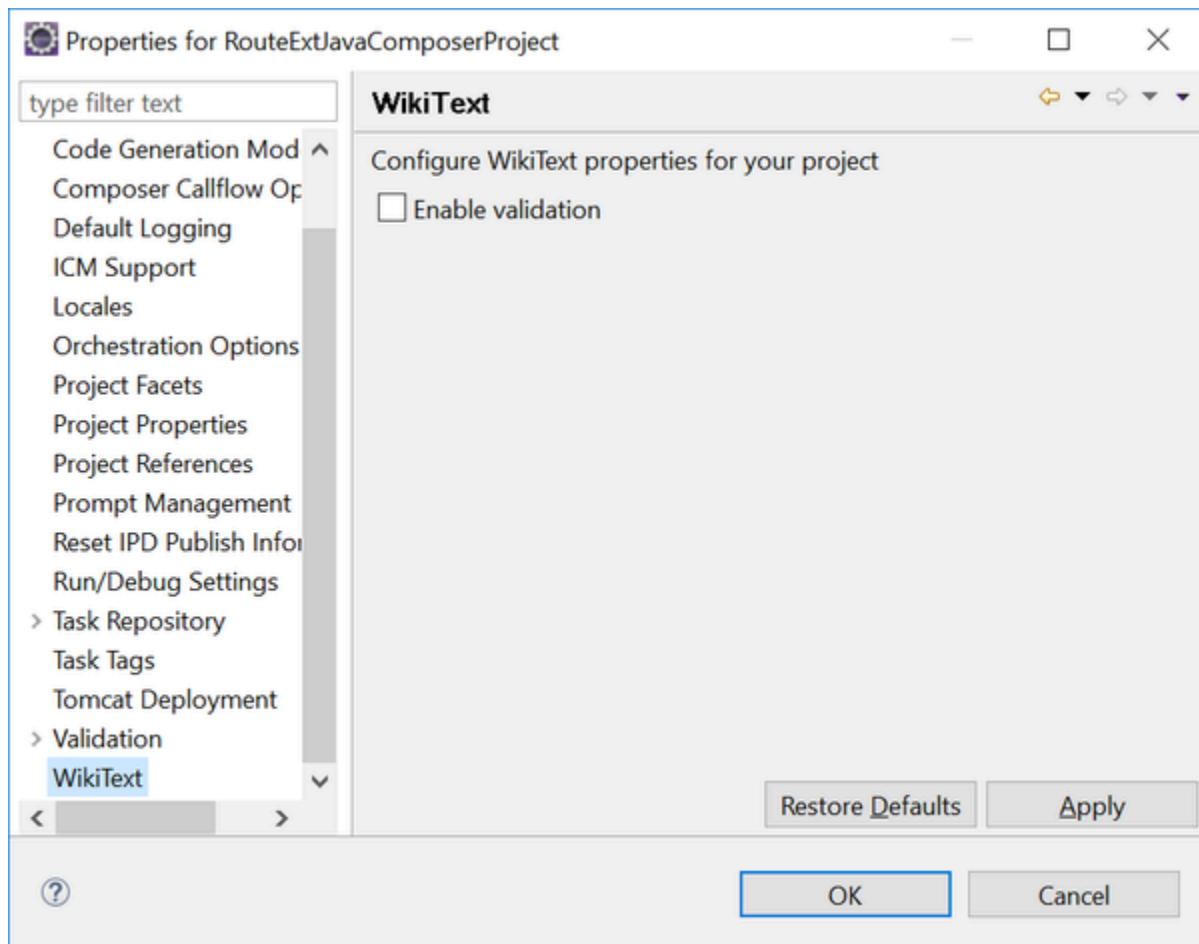

Selecting **Enable validation** causes WikiText to validate wiki markup files in your project. This is done as part of the Project build process, so it helps to have automatic building enabled (Preferences >Workspace >Build Automatically). Validation is performed on all resources that match a wiki markup file extension. In addition, validation includes any files for which the markup language setting was set, even if the file does not have a registered wiki markup file extension.

Multiple User Environments

When more than one Composer user attempts to log into the same Workspace, the following message appears: Workspace in use or cannot be created, choose a different one. Whenever Composer uses a Workspace, it locks the Workspace so other Composer instances cannot access it. A Workspace is meant to be a "private" development area, until the developer decides to share it with the team. It is not possible to share a single Workspace among multiple users, so you need to set up (private) workspaces for each developer. To merge the work of different developers together, use source control, which could be SVN (Subversion), Git, or something else. This is the best way to manage a Composer Project with multiple users working simultaneously on it, and prevent the developers from interfering with each other's work.

You could consider the Subversion plugin in Composer as a connector to source control like SVN. To install the Subversion plugin, see [Software Updates Functionality \(Plugins\)](#). Continuing with this example, once the Subversion plugin is installed, the Project can be shared using source control. When you right-click on a Project, you will find all the relevant options under the Team menu. For the first time, a Project needs to be shared with source control. After this, there will be options on the Team menu.

Security Configuration

You have the option of configuring:

- A secure Transport Layer Security (TLS) connection between Composer and Universal Contact Server (UCS) during application design when [connecting to Context Services](#).
- A secure TLS connection when [connecting to Configuration Server](#) during design time.

You can also configure:

- A security banner that displays when users establish a Configuration Server connection.
- An inactivity timeout. If a Composer user has authenticated with Configuration Server, Composer times out after a configurable number of minutes of inactivity.
- Both certificate-based and key-based authentication.

For information on configuring the above features, see the [Genesys Security Deployment Guide](#).

Upgrading Projects and Diagrams

When deciding whether to upgrade, consult the [Composer 8.1.x Release Note](#) for a summary of new features and other updates.

Important

Composer does not support upgrading diagram files from 8.0.4 versions to 8.1.2 or higher versions. If a callflow/workflow diagram upgrade is required, first upgrade the Projects to 8.1.1 versions and then upgrade to 8.1.2 or higher versions.

Project Upgrade Report

Introduced in 8.1.400.33. Whenever a Project is imported into the workspace as part of the process of upgrading to a newer version, you must perform a Project Upgrade. Composer applications will not work or work unpredictably unless the Project is successfully upgraded. Right-click the Project and select **Upgrade Composer Project**. After the upgrade completes, a Project Upgrade report appears in the design area. An example is shown below.

Project Upgrade Report			
<i>Project Details</i>			
Project Name	MyRouteAfterAutoResponse	Project Type	Java Composer Project
Project Version	8.1.420.12	Composer IP version	8.1.430.02
Project Location: C:\Users\bonniem\workspace\MyRouteAfterAutoResponse			
Upgrading Project contents From 8.1.420.12 To 8.1.430.02			
<i>Changes Details</i>			
[+] Project Changes			
[+] RouteToAgentWithAutoResponse.workflow			
[+] RouteToAgent.Inprocess			
[+] percent.workflow			
[+] default.workflow			
[+] ProcessAgentReply.workflow			
Project Upgrade has completed successfully.			

Important

Other than when [pooling reusable subflows](#), accessing system resources (include/jsp) across Projects is not supported.

Java Composer Projects

Java Composer Projects were referred to as Java Voice projects in earlier versions of Composer, such as Composer Voice. While working with the current version of Composer, an upgrade is required for a previously-created Composer Project and Project diagrams. If you simply copy diagrams into a new Composer Project instead of upgrading the Project itself, then you must use the diagram upgrade procedure as described below. Genesys recommends that you create a dedicated workspace for 8.1 Projects and do not reuse the previously created workspace. This will provide a clean separation between the two versions as well as ensure that a backup copy is preserved for later reference or rollback.

Upgrade Summary

A summary of the Composer diagram upgrade process is as follows:

1. Obtain Composer 8.1 through Genesys Technical Support.
2. Uninstall the older version of Composer. Before uninstalling the older version of Composer:
 - Make a copy of your Composer workspace folder (which contains all your Project files), as your workspace may be deleted if it is located under the installation directory (C:\Program Files\GCTI\Composer 8.1\workspace).
 - Uninstall the older version of Composer.
3. Install Composer 8.1.
4. Upgrade at a Project level or at the Diagram level as described below.

Routing Upgrade Limitations

See [IRD To Composer Migration Guide](#).

Project Upgrades

A Project-level upgrade will automatically apply diagram-level upgrades for all the diagram files directly residing within the diagram (Callflows or Workflows) folder. As part of the upgrade process, Composer makes a back-up of the Project and its files, which are saved under the archived folder; for example: `./JavaComposerProject/archive/JavaComposerProject20100809184446388.zip`

Note: If you are using your previous Workspace, importing Projects is not required. For a new Workspace folder, Projects have to be imported.

Important

Composer does not support importing projects directly from network mapped drives. Instead, you can use shared drives to load and deploy Composer projects into the Tomcat server.

To upgrade a Project when using a new Workspace folder:

1. Import an old Composer Project into Composer's Project Explorer view. From the menu, select **File > Import**.
2. In the Import dialog, navigate to **General** and double-click **Existing Projects into Workspace**.
3. Browse to the Composer Project location and select the Project(s).
4. Mark the checkbox **Copy projects into workspace**.
5. Click **Finish**.
6. In the Project Explorer, select the imported project and type **F5** to refresh.
7. Right-click the imported Project and select **Upgrade Composer Project** from the context menu.
8. If the Project is upgraded, a message appears indicating that it is the current version. Otherwise, a prompt appears asking if you would like to upgrade this Project. Click the **Yes** button to start the upgrade process.
9. View the upgrade report. Once the upgrade process is complete, Composer displays a report. The report is located in the Reports folder of the Project; for example: C:\Work\Temp1\Gate3IPTest\Reports\UpgradeReport_Gate3IPTest20090513155840979.html

Project Version Validation

Starting with Release 8.1.410.14, Composer validates the Project version during the **Generate All** and **Upgrade Project** operations. Projects of a version lower than installed version are validated to upgrade before continuing with these operations. Projects of a version higher than the installed version are not allowed to proceed with these operations.

Example Scenarios

Scenario #1

- Create A JAVA/.NET Project in any older version of Composer.
- Uninstall the older version and install Composer 8.1.410.xx.
- Open Eclipse and import the Project.
- Right click the Project and select **Generate All**. The **Finish** button is disabled state. The Generate All dialog shows Project is not up-to-date, upgrade the Project and then Generate Code. The error message is Project version is not up-to-date. Project version should match the Composer IP version.

Scenario #2

-
- Create A JAVA/.NET Project in any older version of Composer.
 - Uninstall the older version and install Composer 8.1.410.xx.
 - Open Eclipse, select the **Project** menu from the menu bar and select **Build Automatically**.
 - Import the Project and open the **Problems** view. A warning message appears: The diagram version is not up-to-date. Consider upgrading the diagram or the enclosing Project.

Scenario #3

- Create a JAVA/.NET Project in Composer 8.1.410.xx.
- Uninstall 8.1.410.xx and install an earlier Composer 8.1.410.xx version.
- Open Eclipse and perform a **Generate All** or **Upgrade Project**. A warning message appears: Mismatched project version or Project version is higher than IP version.

Workbench Project builds will validate Project versions and show any error in the Problems View.

Intra Version Upgrades

Starting with Release 8.1.400.33, Composer Project and Diagram upgrades between minor versions are now supported (for example, 8.1.400.26 to 8.1.400.32). This enables upgrading diagrams to the IP version from both the major and minor versions. An intra-version upgrade for an IPD diagram to the 8.1.400.33 version works as follows:

1. IPD events are categorized to media-specific sets to improve the interaction handling. Please check the [Events property](#) for more details on this and the items below.
1. The pre-defined sets are non-editable: **Voice**, **Multimedia**, and **Ixn-less** processing.
1. A **Custom** category can be used for customizing the events.
1. If Events were customized, an upgrade from 8.1.301.01 versions and later would use the Custom category. Older versions will be chosen to one of the pre-defined sets based on the media-specific blocks used in the IPD diagram.
1. If Events are not customized, one of the predefined sets will be selected upon an upgrade.
1. Using the pre-defined sets provides improved future upgrades.
1. In the case where a Composer upgrade overwrites any custom changes, use the **Load Last Revision** option in the Events dialog to reload the selected event to the last revision. This is applicable only for the **Custom** category.

Upgrade Error Message

After a Composer Project upgrade, the Project Upgrade Report may display the following error message: error while updating the `.studio_config.properties` file or error while

updating the `.composer` file. In this case, permissions for the `.studio_config.properties` and/or the `.composer` file may be read-only or hidden. To resolve this issue, go to the file system and check for the `studio_config.properties` file and the `.composer` file located under the Composer Project directory. Set the file permissions so that the read-only and hidden file attributes are disabled/unchecked. Hint: To find where the current Project directory is located, do the following:

1. Go to Composer's Project Explorer view.
2. Right-click the Composer Project.
3. From the shortcut menu, select **Properties** > **Resource** and look for **Location.**, for example, Location: `C:\Program Files\GCTI\Composer 8.1\workspace\JavaComposerProject`.

Tip

While upgrading Composer 812 projects to higher versions, if you encounter the error, *The project is corrupted or version higher than the IP version. Project cannot be upgraded.*, check the `.studio_config.properties` file for unwanted timestamp texts and remove them. The `.studio_config.properties` file must not have multiple lines and any extra characters and must only contain the following:
`createdVersion=8.1.2xx.xx.`

Diagram File Upgrade

Important

Composer does not support upgrading diagram files from 8.0.4 versions to 8.1.2 or higher versions. If a diagram upgrade is required, first upgrade the Projects to 8.1.1 versions and then upgrade to 8.1.2 or higher versions.

In Composer 8.0.2 and later, diagrams for voice applications are called callflow diagrams whereas in earlier versions of Composer they were called *studio diagrams*. Follow the steps below if you have only copied older diagram files to a current version of Composer Project (or to an already upgraded Composer Project).

1. In Composer's Project Explorer, select the Project destination folder to where you want the files to be imported, such as the Callflows or Workflows Project folder.
2. Right-click and select **Import**.
3. In the Import wizard, select the diagram files to import.
4. After the import operation completes, right-click the imported diagram file and select the upgrade option: **Upgrade Callflow Diagram** or **Upgrade Workflow Diagram**.

Changes as a Result of Upgrading

It is important to note the following:

- When upgrading to 8.1.1, references to internal variable names may have to be edited manually. See [Variables Project and Workflow, Internal Variables Naming](#) for details and examples. It is recommended that internal variables such as DB Data block database result variables not be used; instead, create User variables to store these results.
- A Project upgrade does not upgrade any custom blocks. When Composer is launched, it checks if any custom blocks need upgrading and upgrades them. There are no manual steps involved.
- When upgrading to 8.0.4/8.1, Project upgrading creates the folder `./WEB-INF/lib`, copies files from `./lib` to `./WEB-INF/lib`, then removes the `./lib` folder from the Java Composer Project.
- When upgrading from 8.0.2, the [Entry block variable](#) `_COMPOSER_WSSTUBBING` is renamed `COMPOSER_WSSTUBBING`.
- When upgrading from 8.0.1 to 8.0.2, the Studio Diagram file extension changes from `.studio_diagram` to `.callflow`. For example: `MyDiagram.studio_diagram` changes to `MyDiagram.callflow`.
- To avoid any resulting file name conflict, the diagram upgrade will append a timestamp to the file name only if a `.callflow` file with the same file name already exists in the same folder; for example: `Main_2010_02_19_123010.callflow`. The Timestamp is of the following format: `yyyy_MM_dd_HHmms`
- Starting with 8.0.2, the following callflow blocks contain a mandatory Output Result property: [Menu](#), [DB Input](#), [Grammar Menu](#), [Input](#), [Get Access Number](#), [Transfer](#), [Statistics](#) and [Record](#). You supply this property by selecting a variable. Since this property is mandatory; if not supplied, an error occurs in the Problems View when validating the callflow.
- Upgrading to 8.0.2 or higher automatically populates this variable. For example, if the block is a Menu block and the block's name is `Main_Menu`, upgrading will add a `Main_Menu` variable to the Entry block (as if you added it manually) and will set the Output Results property to this variable.
- The GVP Next Generation Interpreter does not support the `error.badfetch.badxmlpage` event. If upgrading a callflow application from an earlier version that listed this event under Supported in its Entry block Exceptions dialog box, you will need to modify that Entry block by removing that event under Supported in the Exceptions dialog box.
- Composer workflow and callflow diagrams do not directly store diagram grid information. This preference is workspace-specific. If you are using a new workspace, you can set this value prior to upgrading Projects and diagrams so that the grid information does not change during the upgrade process.

Note: Workspace preferences can be exported and imported from **File > Export or Import > General - Preferences**.

Command Line Code Generation

A command line option is available in Composer to generate code for all diagrams for all Projects in a Workspace.

```
eclipse.exe -application com.genesyslab.composer.voice.generator.commandline.app  
-nosplash -console -consoleLog -data .\workspace -options
```

Where:

- You open the command prompt as Administrator.
- You execute the command line application under where `eclipse.exe` is located.
- `.\workspace` is the relative path to the workspace from where the command line is run. You can specify an absolute path.
- Code will be generated for all the diagram files irrespective of the options specified.
- At least one of the below options is specified.

Options

Option	Description	Comment
-p	Upgrade the Projects in the workspace including common and diagram files. Mutually exclusive with -u option (recommended option).	Note: The -p option does not work for Composer Maven projects.
-u	Upgrade diagram files only. Mutually exclusive with -p option.	
-d	Deploys the .NET Project to the IIS Web Server. Port number must be specified, for example, -d 80. For .NET Projects, open the Command prompt as Administrator.	
-j	Deploys the Java Project to the Tomcat web server. Port number must be specified, for example, -j 8090. For Tomcat admin role access login should be admin/admin.	
-i	Update the IPD diagrams Events Property to Voice default set.	
-c	Publish IPD to Configuration Database. Publishes to default Tenant. Parameters: \$CMEApplicationName\$ \$HostIP\$ \$CmePort\$ \$UserName\$ \$Password\$	Release 8.1.410.14 adds support publishing IPDs at the command line:

Operation Status

Starting with release 8.1.530.17, a report in text format is displayed at the console, indicating the status of the operation being performed (success/failure), and Composer returns an exit code of 0 or 1.

- 0 indicates success and 1 indicates failure.



```

Eclipse

Java was started but returned exit code=1
-Dosgi.requiredJavaVersion=1.7
-Xms256m
-Xmx1024m
-Djava.class.path=C:\Users\ymohanda\Documents\My Received
Files\ eclipse-committers-mars-R-win32\ eclipse-aux\ eclipse-committers-mars-R-
win32\ eclipse\ plugins\ org.eclipse.equinox.launcher_1.3.100.v20150511-1540.jar
-os win32
-ws win32
-arch x86
-launcher C:\Users\ymohanda\Documents\My Received
Files\ eclipse-committers-mars-R-win32\ eclipse-aux\ eclipse-committers-mars-R-
win32\ eclipse\ eclipse.exe
-name Eclipse
--launcher.library C:\Users\ymohanda\Documents\My Received
Files\ eclipse-committers-mars-R-win32\ eclipse-aux\ eclipse-committers-mars-R-
win32\ eclipse\ plugins\ org.eclipse.equinox.launcher.win32.win32.x86_1.1.300.v20
150602-1417\ eclipse_1611.dll
-startup C:\Users\ymohanda\Documents\My Received
Files\ eclipse-committers-mars-R-win32\ eclipse-aux\ eclipse-committers-mars-R-
win32\ eclipse\ plugins\ org.eclipse.equinox.launcher_1.3.100.v20150511-1540.jar
--launcher.appendVmargs
-product org.eclipse.epp.package.committers.product
-application com.genesyslab.composer.voice.generator.commandline.app
-console
-consoleLog
-data C:\testComposerProject_exit_code
-j 7070
-p
-vm C:\Program Files (x86)\Java\jre1.8.0_161\bin\client\jvm.dll
-vmargs
-Dosgi.requiredJavaVersion=1.7
-Xms256m
-Xmx1024m
-Djava.class.path=C:\Users\ymohanda\Documents\My Received
Files\ eclipse-committers-mars-R-win32\ eclipse-aux\ eclipse-committers-mars-R-
win32\ eclipse\ plugins\ org.eclipse.equinox.launcher_1.3.100.v20150511-1540.jar

OK

```

In addition to displaying an exit code, when an exit code of 1 is returned, Eclipse will display a pop-up message (sample shown below). To suppress this message prompt, you can add the `--launcher.suppressErrors` switch to the command.

Beginning with release 8.1.540.07, different exit codes are returned (see table below) to help identify which operation has failed:

Operation	Exit Code
Diagram related errors (code gen)	1
Tomcat/IIS Deployment (-j & -d)	2
Project upgrade (-p & -u)	3
IPD Publish (-c)	4
IPD Event update (-i)	5

Important

If multiple issues are present in the workspace (say for instance that both deployment and code generation has failed), then the most recently executed operation's exit code is returned. So, if project deployment and code generation fails in the Composer workspace, the exit code 1 is returned to indicate that code generation has an issue, and once that is fixed, issue with project deployment - that is, the exit code 2 is returned. In short, exit codes are returned in the following order: Code Generation > IPD Publish > Project Deployment > IPD Diagram update > Diagram upgrade > Project upgrade.

Notes

- Eclipse should not be running. This command line will launch a headless instance of Eclipse that will exit once code generation is complete.
- Eclipse.exe should be executed from its installed location.
- .\workspace is the relative path to the Workspace that contains your Projects for which code should be generated. This will generate code for all supported types of diagrams:
 - callflow : VXML
 - sub-callfow : VXML
 - workflow : SCXML
 - sub-workflow : SCXML
 - interaction process diagram : SCXML

Examples

Project Upgrade Report

```
eclipse.exe -application com.genesyslab.composer.voice.generator.commandline.app  
-nosplash -console -consoleLog -data .\workspace -p )
```

Publishing IPDs

```
eclipse.exe -refresh -application  
com.genesyslab.composer.voice.generator.commandline.app -nosplash -console  
-consoleLog -data "WorkspacePath" -c $CMEApplicationName$ $HostIP$ $CmePort$  
$UserName$ $Password$
```

Working with Diagram Layouts

Composer routing workflow and voice callflow diagrams follow a vertical layout scheme by default. The in port of a block is always positioned at the top of the block while one or more out ports are positioned at the bottom edge of the block. Exception ports are displayed on the left edge. Following this vertical layout can quickly exceed the available vertical screen space. The **Outline view** can then be used to determine which part of a large diagram is being displayed currently and to quickly navigate to a different part by clicking the outline view.

It is possible to follow a horizontal layout where the in ports and out ports can be manually repositioned to any edge of the block and lose some features. For example, elbowed (bent) connectors and individual ports may not display on the block making it difficult to know how many unconnected ports are present and also to connect out ports out of order. See **Show Connection Ports** for more details. Please note that switching between the default vertical layout and the more flexible horizontal layout will rearrange **connection links** and manual rearrangement may be necessary. While working with diagrams, you may run into odd looking links. The figures below show some of these and lists suggestions on how to fix them.

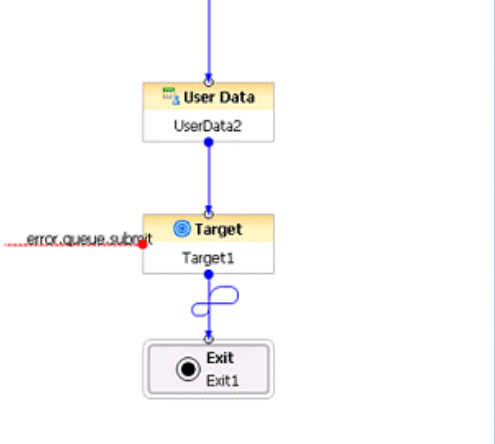
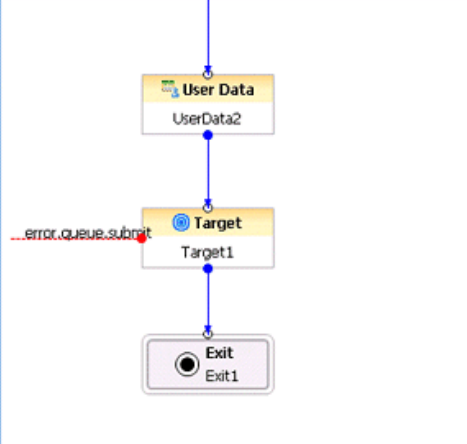
	Link Issue	Steps to resolve	End Result
1.		<p>Grab the extreme left and right points of the infinity curve and coax them towards the center until they merge into the vertical line.</p>	

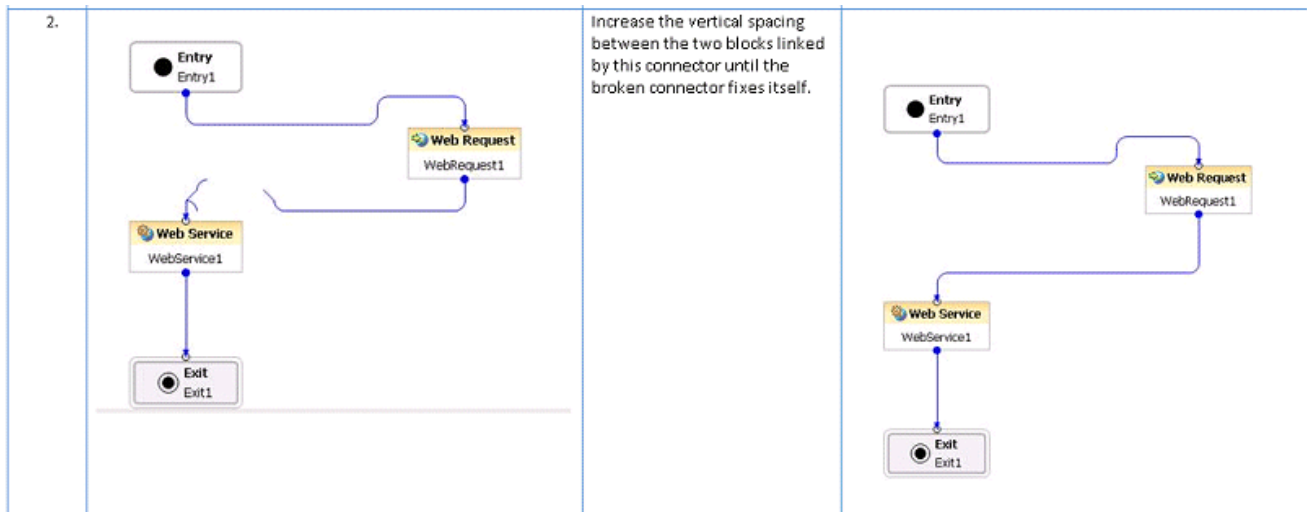

To make it easier to align blocks, Composer diagrams have enabled "just in time" guides. They show up when a block is dragged near another block, when blocks are aligned, and help for about a second. To place the block in an aligned position, drop the block when the guides confirm the block is aligned.

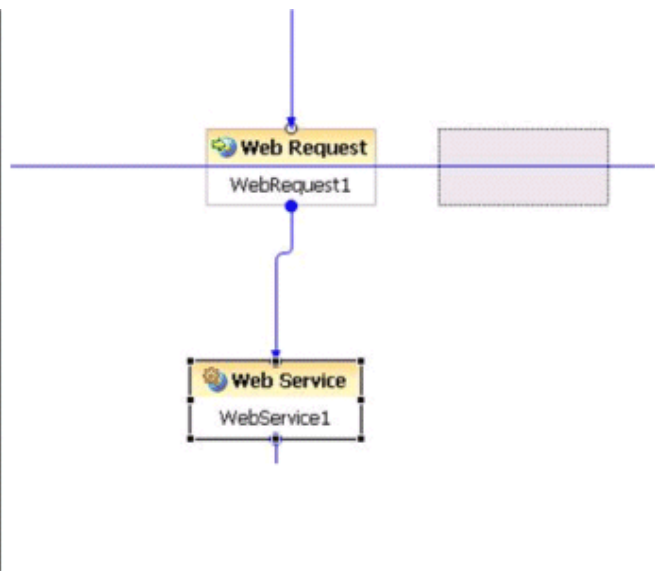

Accessing the Editors and Templates

Composer editors are embedded/integrated within the user interface and are made available to you whenever a .scxml, .vxml, .ccxml, .grxml, or .jsp file is created or accessed within Composer.

Creating a New File

In **Composer** or **Composer Design** perspective, create a new VoiceXML, SCXML, or CallControlXML file as follows:

- Select **File > New > Other > Composer > Others > Others > Others**.
- Select the file type, such as SCXML.
- Select the parent folder; usually an existing Project.
- Enter a name for the file.
- If applicable, click **Advanced** to link to the file system and use an existing file.
- Click **Finish**.

Using an Existing Template

- Select **File > New > Other > Composer > Others**.
- Select the file type.
- Select the parent folder; usually an existing Project.
- Enter a name for the file.
- If applicable, click **Advanced** to link to the file system and use an existing file.
- Click **Next**.
- Select the template.
- Click the **Use SCXML Template** checkbox.
 - Click **Finish**.

The editor opens with your new file. When working with XML files, the view contains **Source** and **Design** tabs. All editor functions described at the top of this topic are available to you. The appropriate Composer editor also opens whenever you open an existing .vxml, .ccxml, .grxml, .aspx, or .jsp file, whether previously created as described above, or previously imported into Composer.

Open an Existing File

Open an existing file as follows:

- Select **File > Open File**.
- Navigate to the file to open, OR

Open a Composer Project's src or src-gen folder in the Project Explorer, then double-click the file to open it in the editor.

Creating a Custom Code Template

When writing manual SCXML/VXML/CCXML/GRXML code in the file editors, you may run into code that becomes repetitive. You may consider creating a code template to avoid retyping this block of code. Creating templates will improve the speed and consistency for writing code. The following steps show how to create a code template.

- Select **Window > Preferences**.
- In the Preferences dialog box, navigate through the Composer category, and expand the file type (VXML Files / CCXML Files / GRXML / SXCML Files) in which you want to add your template. Then select the **Templates** section. For example, select VXML Templates.
- Click the **New** button to add a new code template.
- Fill in the fields for the new template. The Context drop down box specifies at what context level you want the code template to appear as a context sensitive help.
- Click the **OK** button when finished.

XML File Preferences

You can also set XML File Preferences: **Window > Preferences > XML > XML Files**. When specifying Encoding formats in the XML Preference page: encoding formats are applicable only for new File creation using the Template option: (**File > New > XML > XML File > Create XML File from an XML Template > Select XML Template**). This applies only to new XML, VXML, CCXML and SCXML files. Existing files within the Project will not get impacted.

Creating a Backend JSP File

- Create a new JSP file by selecting **File > New > Backend JSP file**.
- In the **Create Backend JSP File** folder, navigate to the src folder within the Java Composer Project in which the Backend JSP file belongs.
- Type a name In the **File Name** field.

- Click **Finish**.

The Editor opens with a JSP file template. You can see your new file in the src folder of your Java Composer Project in the Project Explorer. A template is provided when you create a new Backend JSP file in Composer. You implement a performLogic method as a JSON object, store a result and return it to the voice application if desired. You have the flexibility to enter any valid JSP code that you wish.

Creating a Backend ASP .NET File

- Create a new ASP.NET file by selecting **File > New > Backend ASPX file**.
- In the ASPX File folder, navigate to the include folder within the .NET Composer Project in which the Backend ASPX file belongs.
- Type a name in the **File Name** field.
- Click **Finish**.

The Editor opens with an ASPX file template. You can see your new file in the include folder of your .NET Composer Project in the Project Explorer. A template is provided when you create a new Backend ASPX file in Composer. You implement a performLogic method as a JSON object, store a result and return it to the voice application if desired. You have the flexibility to enter any valid ASP.NET/C# code that you wish.

Keyboard Shortcuts

When working in Composer, you can use the following keyboard shortcuts. Click in the Package Explorer on the left. Then use the keyboard shortcuts shown below.

Ctrl+Alt+P	Create new interaction process diagram	Create Interaction Process Diagram Wizard opens
Ctrl+Alt+J	Create new Java Composer project	Wizard for Java Composer project opens
Ctrl+Alt+T	Create new .NET Composer project	wizard for .NET Composer project opens
Ctrl+Alt+O	Create a new voice callflow	Callflow Diagram wizard opens
Ctrl+Alt+R	Create a new routing workflow	Workflow Diagram wizard opens
Alt+I+C	Open dialog box for connecting to Configuration Server	Connect to Configuration Server dialog box opens
Alt+I+D	Disconnect from a connected Configuration Server	A connected Configuration Server is disconnected
Ctrl+Alt+C	Generate all	Brings up the Generate All wizard. Creates properly formatted VoiceXML (callflows) or SCXML (workflows) diagram files for the Project.
Alt+M	Open Prompt Manager perspective	Prompt Manager perspective opens
Alt+P+P	Open Project properties	Properties dialog box opens
Alt+H	Open Composer Help	Help menu appears. Select Help Contents.
Alt+H+C	Open Cheat Sheet	Help menu appears. Select Cheat sheets.
Alt+H+A	Open About Composer	About Composer dialog box opens
Ctrl+Alt+D	Open Database Connection Profiles	Database Connection Profiles opens
Ctrl+Alt+S	Open Statistic Builder	Statistic Builder opens.
Space	To toggle a check box	The check box mark toggles on/off
Alt+A	Jump to an Add button in a wizard	The Add button is selected
Alt+D	Jump to a Delete button in a wizard	The Delete button is selected
Alt+R	Jump to a Remove button in a wizard	The Remove button is selected

ALT+U	Jump to an UP button in a wizard	The UP button is selected
ALT+W	Jump to a DOWN button in a wizard	The DOWN button is selected
Alt+T	Jump to a Test/Preview button in a wizard	The Test/Preview button is selected
Alt+R/Alt+W	Jump to a Browse button in a wizard	The Browse Event button is selected
Alt+B	Jump to a Back button in a wizard	The Back button is selected
Alt+N	Jump to a Next button in a wizard	The Next button is selected
Alt+F	Jump to a Finish button in a wizard	The Finish button is selected

Default Logging

For information on setting Default Logging, see the figure in topic [Project Properties](#).

IRD Functionality Included in Composer

Composer enables you to create SCXML-based routing applications to run on the Universal Routing 8.x platforms and, as such, it includes functionality that was previously provided through Genesys **Interaction Routing Designer** (IRD). The information below is provided for existing Genesys customers transitioning to Composer, who are familiar with creating strategies in IRD.

Composer Blocks and IRD Objects

Composer refers to the fundamental element of a workflow as a *block*; whereas in IRD documentation, this element is referred to as an *object*. The tables below group IRD objects based on their IRD toolbar category name and point to the corresponding functionality in this release of Composer. Summary information is presented below.

- Learn about the **differences** between Composer and Interaction Routing Designer, which has historically been used to create routing applications.
- See the Composer **Quick Start** for how to create a simple routing strategy, attach data that will appear on the agent desktop, and route to the preferred agent.

Data & Services

IRD Object Name	Composer Block Name	Description
Database Wizard	DB Data	DB Data retrieves information from the database. Uses a Query Builder .
Web Service	Web Service	Invokes Web Services. GET, POST and SOAP over HTTPS are supported.
	Web Request	Invoke any supported HTTP web request or REST-style web Service. See sample: Routing Based on Web Request .

Also see Composer's **Server Side Blocks**.

Miscellaneous

IRD Object Name	Composer Block Name	Description
Assign	Assign	Assigns a computed value/ expression or a literal value to a

Multi-Assign		variable. Variables are defined in the Entry block. Capable of multiple assignments.
Call Subroutine	Subroutine	Creates reusable sub-modules.
Entry	Entry	Sets global error (exception) handlers. Defines global variables (see Variables section below).. All routing strategy diagrams must start with an Entry block.
Exit	Exit	Terminates the strategy and returns control back to calling workflow in case of a subroutine.
Error Segmentation	Multiple error output ports can be created in Composer blocks based on each block's Exception property.	
Function Multi-Function	ECMAScript	Builds an ECMAScript expression using the Expression Builder . Many URS functions are available as Genesys Functional Modules described the Orchestration Server Documentation Wiki can invoke multiple functions.
If	Assign , Branching , ECMAScript blocks all open Expression Builder	Expression Builder can be used to create IF expressions.
Multi-Attach	ECMAScript	Can be used for attaching data to an interaction.

Also see Composer's [Routing Flow Control Blocks](#).

Routing

IRD Object Name	Composer Block Name	Description
Selection	Target	Routes an interaction to a target, which can be Agent, AgentGroup, ACDQueue, Place, PlaceGroup, RoutePoint, Skill, or Variable. Skill target uses Skill Expression Builder .
Percentage	Target	Statistics Order property in Target block, lets you perform percentage allocation. Also see sample: Routing Based on Percent Allocation .
Default	Default Route	Routes the interaction to the default destination. Can be

		overridden by the Set Default Route block.
Routing Rule		Orchestration Server 8.1 does not support service level routing rules.
Switch to Strategy		Orchestration Server 8.1 does not support switch to strategy routing rules.
Force Route	Force Route	Not exposed as a routing rule in Composer.
Statistics	Target	Although statistical routing rules are not yet supported as in IRD's Statistics routing object, users can use the Target object Statistic property to route based on the value of a statistic. A Statistics Manager and Builder let you create your own statistics from URS predefined statistics.

Also see Composer's [Routing Blocks](#).

Segmentation

IRD Object Name	Composer Block Name	Description
ANI	Branching	See Your First Application: DNIS Routing for an example.
DNIS	Branching	See Your First Application: DNIS Routing for an example.
Date	Branching	See the sample Routing Based on Date & Time.
Day of Week	Branching	See the sample Routing Based on Date & Time.
Time	Branching	See the sample Routing Based on Date & Time.
Classification Segmentation	Branching	For classification segmentation, an ECMAScript function determines if a particular category name or ID exists in the array of category objects represented by an application variable.
Generic	Branching	Use as a decision point in a workflow. It enables you to specify multiple application routes based on a branching condition.

Also see:

Composer [Common Blocks](#)

[Context Services Blocks](#).

Voice Treatment

See [Composer Equivalent to IRD Treatment](#).

eServices Multimedia

See [Composer Equivalent to IRD Multimedia](#).

Outbound

See [Outbound Common Blocks](#)

Context Services

See [Context Services Blocks](#)

Business Process

See [Interaction Processing Diagrams Overview](#) and [Interaction Process Diagram Blocks](#). Reusable Objects

- IRD List Object: See Composer's [List Object Manager](#).
- IRD Variable List Dialog Box: See Entry block [Variables](#) property.

In contrast to IRD, which defines variables in a special dialog box outside of the strategy, Composer defines both [workflow](#) and [Project variables](#).

Diagram Search

Beginning with release 8.1.500.03, you can search for blocks in diagram files using the **Diagram Search** feature. Both simple and advanced search options are available.

Simple Search

Simple search is limited to the currently active diagram. You can search for a block by its name and if found, the block is selected in the active diagram.

1. Select **Diagram > Find Block** from the menu bar or press **Ctrl+J** from the active diagram. The following dialog is displayed:

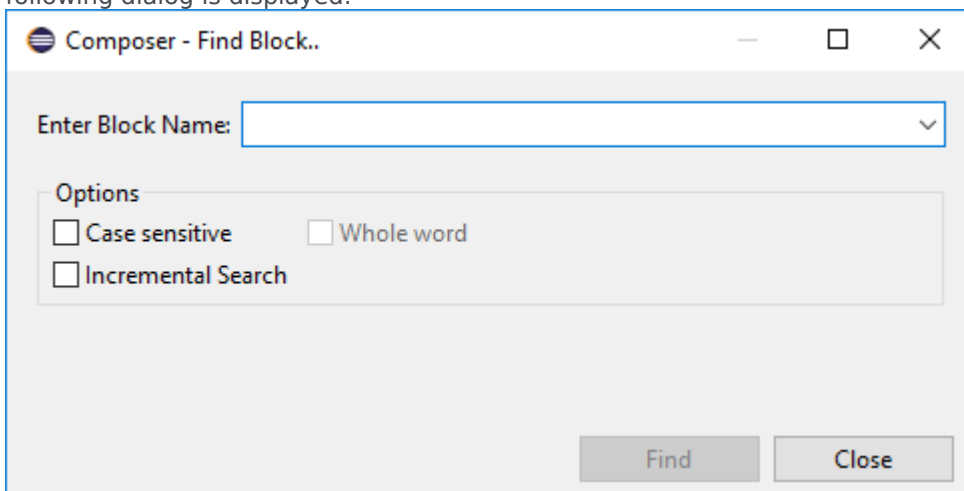

2. Enter the name of the block in the field provided and click **Find**.

Important

You can also use the input drop-down to select and repeat or modify a recent search.

3. In addition you can select one or more of the following checkboxes for additional validation during the find operation:
 - **Case Sensitive:** Select this option to match the casing of the value provided in the input field with the search results.
 - **Whole Word:** Select this option to search for whole words identical to the input value. If this option is not selected, the find operation locates the immediate possible match to the input value.
 - **Incremental Search:** Select this option to progressively search for the blocks and filter through text. As the user types the text, one or more possible matches for the blocks are found and immediately

presented to the user. Composer will begin matching the next find based on what you type. Additionally, once you have typed your search string to the length you desire, you can press **Enter** on the keyboard or the **Find** button to continue searching for other occurrences of the block names matching the text input you have typed.

Advanced Search

Advanced search provides options to search by block name, block type, and diagram types. You can also extend the search to include the complete project that the active diagram is part of or even the current workspace that is being accessed. Advanced search results are listed in a separate **Search Results** page in the **Search** view.

Important

Regular expressions are not supported.

1. Press **Ctrl+H** from the active diagram. The Eclipse **Search** dialog is displayed.
2. Select the **Diagram Search** tab. The following is displayed:

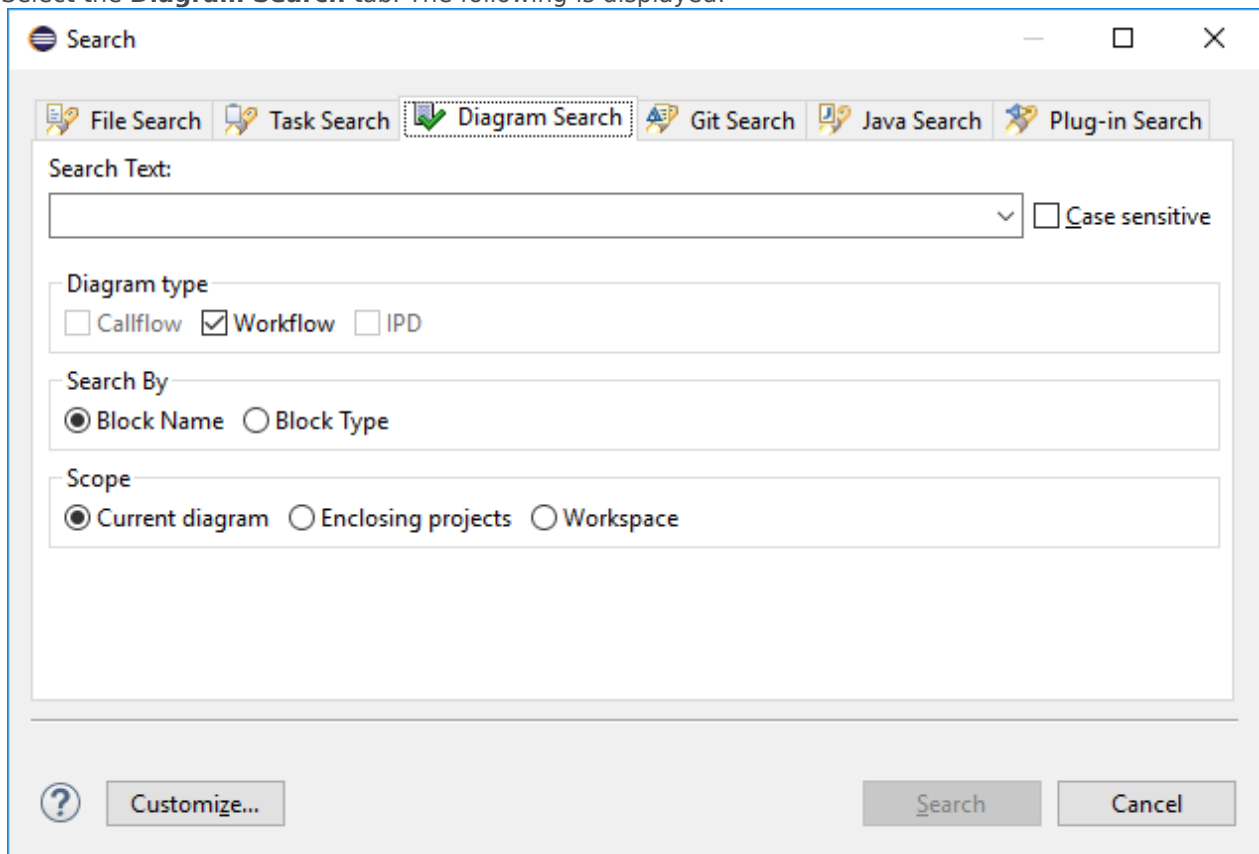

3. Enter the name of the block in the field provided and click **Search**.

Important

You can sort the listed results by any of the four columns; **Block Name**, **Block Category**, **Diagram File**, or **Project Name**. Click an item from the listed results to locate and then select the associated block in the active diagram.

On the top right corner of the **Search Results** page, the following additional Eclipse search interface options are available:

- **Run the Current Search Again (F5)** - Press F5 or click this icon to run the current search again.
- **Cancel Current Search** - Click this icon to cancel the current search operation.
- **Pin the Search View** - Click this icon to pin the current **Search Results** page. Results of subsequent searches are shown on another **Search Results** page.
- **Show Previous Searches** - Click this icon to open the **Previous Searches** dialog, from which you can run any of the previous searches listed.

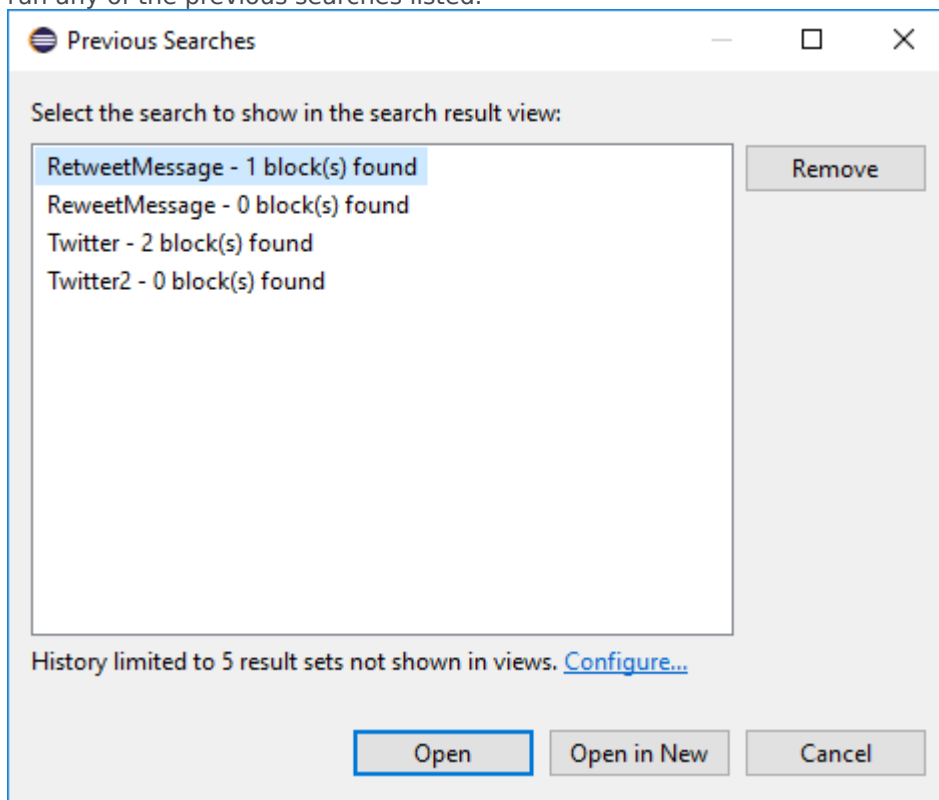

- To run a previous search again, select an item from the list and click **Open** to display the results in the existing Search Results page or click **Open New** to display the results on a new **Search Results** page.
- You can remove an item from the list by selecting the item and clicking Remove.
- The number of previous searches listed in the dialog is configured using the **Configure...** option (hyperlinked text) at the bottom of the dialog.

Important

You can also view previous search items, select and run a previous search, or clear search history by clicking the drop-down next to the **Previous Searches** icon and selecting the required option.

Masking Sensitive Information in Composer Tomcat Logs

Important

This feature is applicable only for Java Composer projects.

Starting with release 8.1.550.08, Composer's Java backend logging support has been upgraded from **Log4j1** to **Log4j2**. This enables sensitive information to be masked in the Composer Tomcat logs using configurable patterns. A new field, **Composer Log Masking Regex Pattern**, is included in the **Default Logging** project-level property, to specify the regex pattern to be used for masking.

The user specified regex pattern from the new field is stored in the **makingPattern.json** file located in the WEB-INF\lib folder within the corresponding Java Composer project folder.

You can use the Default Logging project-level property section to specify the log levels for the Voice and Routing blocks and provide a regex pattern for masking sensitive information in the Composer Tomcat logs. These log levels will be applied to the blocks where the **Log Level** is set to **Project Default**.

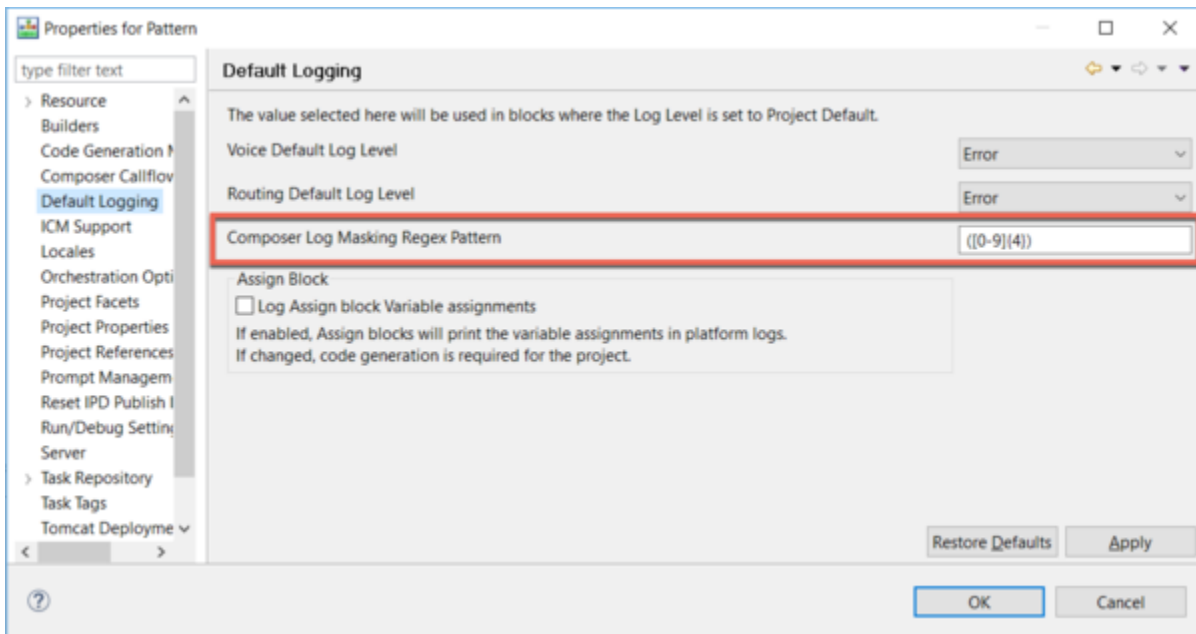

Composer will need administrator privileges if the project's workspace location is under the EXE installation directory (C:\Program Files (x86)\). In this case, run Composer as an administrator when providing the regex pattern in the new **Composer Log Masking Regex Pattern** field in the **Default Logging** project-level property section.

Here is a short video on masking sensitive information in Tomcat Logs:

[Link to video](#)

Masking Sensitive Information in ORS/GVP Application Logs

Starting with release 8.1.550.08, the existing log levels functionality has been enhanced to apply to all log expressions generated as part of VoiceXML or SCXML code snippets. This helps mask sensitive information in ORS/GVP application logs. Earlier, log levels were applicable only for custom log expressions specified in a block's properties.

Important

All Composer blocks in both Callflow and Worklfow diagrams provide properties to configure log levels except the VXML Form block (in callflows) and SCXML State block (in workflows).

Log levels can be used to control the expressions being printed in the ORS/GVP log files. They can be used to mask sensitive information by increasing or decreasing the the log levels as required to control the level of detail printed in the log ORS/GVP log files.

Composer Menus

Tip

This help wiki discusses the menu items that you use for Composer. Other menu items are part of the Eclipse integrated development environment.

This section discusses Composer's top-level menus.

- [FileMenu](#)
- [EditMenu](#)
- [DiagramMenu](#)
- [NavigateMenu](#)
- [SearchMenu](#)
- [ProjectMenu](#)
- [ConfigurationServerMenu](#)
- [RunMenu](#)
- [Window_Menu](#)
- [Help_Menu](#)
- [CanvasShortcutMenu](#)
- [PaletteGroupMenu](#)

File Menu

The commands active in the File menu change depending on the object you have selected, the perspective, and where you are within the perspective. Commands available from the File menu are described below. Also see the [Hiding File Types](#) topic.

<p>New (Alt+Shift+N)</p>	<p>Select New > Other, which can be a new:</p> <ul style="list-style-type: none"> • Java Composer Project • .NET Composer Project • Project • Callflow Diagram • Workflow Diagram • Grammar builder file • VoiceXML file • SCXML file • GrammarXML file • CallControlXML file • Backend JSP file • Folder • File <p>You can also select Example... or Other... (for example, to create a new Interaction Process Diagram). Both of these bring up the Select a Wizard dialog box.</p>
<p>Open File</p>	<p>Opens the selected object.</p>
<p>Close (Ctrl+W)</p>	<p>Closes the current callflow or workflow diagram in the canvas.</p>
<p>Close All (Ctrl+Shift+W)</p>	<p>Closes all open elements in the workbench area.</p>
<p>Save (Ctrl+S)</p>	<p>Saves the selected object.</p>
<p>Save As</p>	<p>Saves the selected object under another name</p>
<p>Save All (Ctrl+Shift+S)</p>	<p>Saves all files in all open editors.</p>
<p>Revert</p>	<p>Reverts to an earlier saved version of a file</p>

	selected from the History.
Move	Moves Project resources.
Rename	Renames Project resources.
Refresh	Reloads the configuration.
Convert Line Delimiters To	<p>Converts line delimiters within the callflow design canvas to one of the following:</p> <ul style="list-style-type: none"> • Windows (default) • Unix • MacOS 9
Print	Prints the selected object(s) within the callflow design canvas
Page Setup	Brings up a dialog box where you can specify to use workplace settings or diagram settings. You can also change orientation, units, size, and the margin as well as configure workplace settings.
Print Preview	Previews the output before printing.
Switch Workspace...	Browses for/selects a different workspace storage area. Changes the set of projects and resources that you are working on.
Restart	Restarts Composer.
Import	<p>Brings up a wizard that leads you through the process of importing various types of files.</p> <p>Expand Composer to import from the file systems, such as an IRD strategy or a Realtime Debugger Launch Configuration.</p>
Export	Brings up a wizard that leads you through the process of exporting various types of files.
Properties	Shows properties for the selected resource (such as a Project). When a Project is selected, includes the Deployment property.
Exit	Exits Composer.

Edit Menu

Use the Edit menu to move around within the current application; cut, copy, paste, and delete blocks from the displayed callflow or workflow; find individual blocks within the callflow; and open the Properties dialog box for a selected block. Edit menu items include standard Windows and Eclipse edit functions:

Undo (Ctrl+Z)	After you perform an action on an object, the Undo command becomes Undo <action>. For example, Undo Deleting appears after you perform a deletion.
Redo	Select Redo <action> after using Undo <action> to go back to the most recent edit.
Cut	Removes selected object(s) and moves the objects to the clipboard.
Copy	Copies the selected object(s) to the clipboard.
Paste	Moves copies of selected object(s) from the clipboard to the selected location.
Delete	Deletes the selected object(s).
Select All	Selects all text or objects in the currently active view or editor.
Find/Replace	Use in text files, such as JSP, VXML, CCXML, and SCXML files. Place your cursor inside the file and then select from Edit menu. Not used for callflows or workflows. Brings up the Find/Replace dialog box.
Add Bookmark	When the cursor is positioned on a file in the Project Explorer, opens the Bookmark Properties window. A bookmark helps you quickly navigate to a frequently used resource. You can place an "anchor" either on a resource within the Workbench, or at a specific line within a file, by creating a bookmark. Then you can use the Bookmarks view to return to those files quickly. The Bookmarks view (Window > Show View > Bookmarks) displays all bookmarks that you have created.
Add Task	When a Project is selected in the Project Explorer, opens a properties dialog box. You can associate tasks with an editable resource, for instance to remind yourself to update a line of source code later.

Diagram Menu

This menu contains a number of standard diagram-related menu commands that can be used within the Project Explorer view and callflow/workflow diagram [canvas](#).

Font	Invokes the system font dialog used to modify the font associated with the selected diagram element
Fill Color	Applies a color to the selected diagram element's interior
Line Color	Applies a color to the selected diagram element lines
Line Type	<p>Modifies the style of the selected diagram connector element to one of the following:</p> <ul style="list-style-type: none"> • solid • dash • dot • dash dot • dash dot dot
Line Width	<p>Modifies the width of the selected diagram connector to one of the following:</p> <ul style="list-style-type: none"> • one point • two points • three points • four points • five points
Arrow Type	<p>Modifies either the source end or the target end of the arrow connector element to one of the following:</p> <ul style="list-style-type: none"> • no arrow • solid arrow • open arrow
Line Style	<p>Changes the diagram connector to one of the following:</p> <ul style="list-style-type: none"> • Rectilinear Style Routing • Oblique Style Routing

	<ul style="list-style-type: none"> • Tree Style Routing
Select	Select all diagram elements, all shapes, or all connectors
Arrange	Applies a layout to all diagram elements, or to the selected ones only
Align	Aligns all selected diagram elements to: the left, the right, the center, the top, the bottom, or the middle of the selection
Text Alignment	Aligns the text left, right, or center
Order	Re-orders the selected diagram elements to: the front, the back, forward once, or backward once
Auto Size	Resets the size of the selected diagram elements to the default size, usually just enough to see an embedded label within the shape
Make Same Size	Sets the size of the selected diagram elements to the size of the last selected element, either horizontally, vertically, or both
Filters	<p>Does one of the following:</p> <ul style="list-style-type: none"> • sort/filter Compartment items • show/hide Compartment items <p>(all Compartments or named Compartments only). Compartment items refer to Composite attributes within your editor, which can optionally be collapsed or expanded.</p>
View	<p>Shows or to hides various diagram features:</p> <ul style="list-style-type: none"> • ruler • grid • page breaks <p>Controls the snap to grid behavior.</p>
Zoom	<p>Changes the diagram magnification to one of:</p> <ul style="list-style-type: none"> • in • out • 100% • To Fit • To Width • To Height • To Selection
Apply Appearance Properties	Copies various appearance properties, such as fill color, of the first selected diagram element to the

	other selected ones
Generate Code (Alt+G)	<p>Creates a properly-formatted VoiceXML file from a callflow diagram built with Composer. Static VXML pages (pure VXML code) are generated in the src-gen folder of the Composer Project. This selection is enabled when the Project is selected in the Explorer after a new edit.</p> <p>In the case of a routing workflow, check the Problems tab for errors and fix any problems. If code generation succeeds, click OK at the confirmation dialog box. The SCXML code is generated in the src-gen folder.</p>
Import Custom Blocks	Allows you to import a custom block that was previously exported so the block can be shared across multiple users/installations of Composer.
Export Custom Blocks	Allows you to export a custom block so the block can be shared across multiple users/installations of Composer.
Validate (Alt+V)	Validates the diagram that is open for completeness and accuracy. This selection is enabled when the Project is selected in the Explorer after a new edit.

Navigate Menu

This menu allows you to locate and navigate through resources and other artifacts displayed in the Workbench. The Navigate menu differs from the Find/Replace command on the Edit menu. Instead of entering text to find, the Navigate menu uses directional commands. The Navigate menu contains the following items:

Go Into	Refocuses the active view so that the current selection is at the root. This allows web browser style navigation within hierarchies of artifacts.
Go To	<p>Refocuses the active view to one of the following:</p> <ul style="list-style-type: none"> • Back: Displays the hierarchy that was displayed immediately prior to the current display. For example, if you Go Into a resource, then the Back command in the resulting display returns the view to the same hierarchy from which you activated the Go Into command. This command is similar to the Back button in an HTML browser. • Forward: Displays the hierarchy that was displayed immediately after the current display. For example, if you've just selected the Back command, then selecting the Forward command in the resulting display returns the view to the same hierarchy from which you activated the Back command. This command is similar to the Forward button in an HTML browser. • Up one level: Displays the hierarchy of the parent of the current highest-level resource.
Show In (Alt+Shift+W)	Finds and selects the currently selected resource in another view. If an editor is active, these commands are used to select the resource currently being edited in another.
Next	Navigates to the next item in a list or table in the active view. For example, when the search results view is active, this navigates to the next search result.
Previous	Navigates to the previous item in a list or table in the active view. For example, when the search results view is active, this navigates to the previous search result.
Last Edit Location	Jumps to the last edit position
Back	Navigates to the previous resource that was viewed in an editor. Analogous to the Back button on a web browser.
Forward	Navigates to undo the effect of the previous Back

	command. Analogous to the Forward button on a web browser.
--	--

Search Menu

Search results are displayed in the Search view, which appears if not previously present. The Search menu contains the following items:

Search	Opens the Search dialog box, where you can perform file, text or Java searches. Java searches operate on the structure of the code. File searches operate on the files by name and/or text content. Java searches are faster, since there is an underlying indexing structure for the code structure. Text searches allow you to find matches inside comments and strings.
File	Opens the Search dialog box. If it is not already selected, select the File Search tab. In the Containing text field, type the search string. For a Java search, make sure that the File name patterns field is set to *.java. The Scope should be set to Workspace. Then click Search. Note: To find all files of a given file name pattern, leave the Containing Text field empty.
Text	After selecting text, searches a workspace, a project, a file, or a working set. Working sets group elements for display in views or for operations on a set of elements. They restrict the set of resources that are displayed. If a working set is selected in the navigator, only resources, children of resources, and parents of resources contained in the working set are shown.

Project Menu

The Project menu contains the following items:

Open Project	Opens the currently selected Project(s). The selected Project(s) must currently be closed for this command to be available.
Close Project	Closes the currently selected(s) Projects. Closing a Project will remove all of that Project's state from memory, but the contents on disk are left untouched.
Build All (Ctrl+B)	Performs an incremental build on all Projects in the Workbench. This command builds (compiles) all resources in the Workbench that are affected by any resource changes since the last incremental build. This command is only available if auto-build is turned off. Auto-build is turned off via the Build Automatically menu option or from the General > Workspace preference page.
Build Project	Performs an incremental build on the currently selected Project. This command builds (compiles) all resources in the Project that are affected by any resource changes since the last build. This command is only available if auto-build is turned off. Auto-build is turned off via the Build Automatically menu option or from the General > Workspace preference page.
Build Working Set	Performs an incremental build on a working set. This command builds (compiles) all resources in the working set that are affected by any resource changes since the last build. This command is only available if auto-build is turned off. Auto-build is turned off via the Build Automatically menu option or from the General > Workspace preference page.
Clean	Discards all previous build results. If autobuild is on, then this invokes a full build.
Build Automatically	Toggles the auto build preference on and off. The auto-build preference is also located on the General > Workspace preference page.
Properties	Opens the Project Properties dialog box as described below.

Project Properties

Selecting **Properties** from the Project menu opens a dialog box showing the properties of the selected Project or of the Project that contains the selected resource.

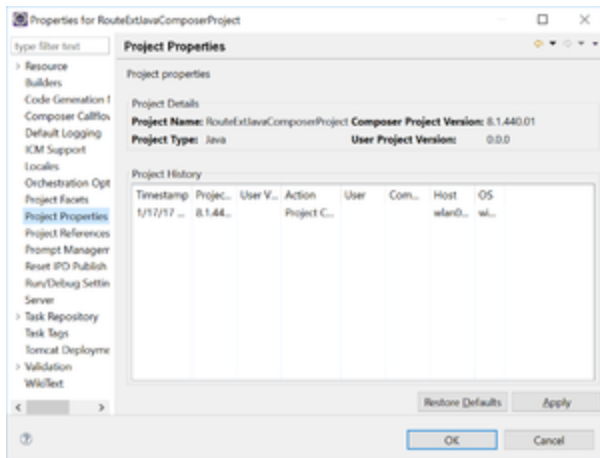

Run Menu

- See the [Debugging voice applications](#) and [Debugging routing applications](#) topics for supported functionality.

The Run Menu contains all of the actions required to run, debug, step through code and work with breakpoints. Different parts of the menu are visible at different times, as each **perspective** can be customized to show only specific capabilities. The Run menu contains the following items:

Resume	Resumes execution of the currently selected Debug target.
Suspend	Halts the execution of the currently selected thread in a debug target. Once the selected thread is suspended, you can then examine it.
Terminate	Terminates the selected debug target.
Step Into	[Disabled for GVP Debugger]
Step Over	Steps over the highlighted statement. Execution will continue at the next line either in the same method or (if you are at the end of a method) it will continue in the method from which the current method was called. The cursor jumps to the declaration of the method and selects this line.
Step Return	[Disabled for GVP Debugger]
Run to Line	[Disabled for GVP Debugger]
Use Step Filters (Shift+F5)	Toggles step filters on and off. When on, all step functions apply step filters.
Run	Re-launches the most recently launched application, or launches the selected resource or active editor depending on the launch operation preference settings found on the Run/Debug > Launching preference page.
Debug	Re-launches the most recently launched application under debugger control, or launches the selected resource or active editor depending on the launch operation preference settings found on the Run/Debug > Launching preference page.
Run History	Displays a submenu of the recent history of launch configurations launched in run mode
Run As	When a callflow is selected, displays Run Callflow. In the Run mode , call traces are provided and the application continues without any breakpoints. Note: Run on Server is an Eclipse feature and is not used by Composer.
Run Configurations	Used for debugging callflow diagrams. Opens the

	Run Configurations dialog box that lets you create, manage, and run launch configurations of different types.
Debug History	Displays a submenu of the recent history of launch configurations launched in debug mode.
Debug As	Displays a sub menu of registered debug launch shortcuts. Launch shortcuts provide support for workbench or active editor selection sensitive launching. Note: Debug on Server is an Eclipse feature and is not used by Composer.
Debug Configurations	Used for debugging callflow diagrams. Opens the Debug Configurations dialog box that lets you create and modify launch configurations and debug applications.
External Tools	Displays external tools that allow you to configure and run programs, batch files, Ant buildfiles, and others using the Workbench. You can save these external tool configurations and run them at a later time. Output from external tools is displayed in the console view. Selecting External Tools presents the following sub-menus: Run As, External Tool Configurations, Organize Favorites.
Create URL Breakpoint	Creates a breakpoint, which suspends the execution of a workflow at the location where the breakpoint is set.
Toggle Breakpoint	Appears in Debugging perspective. Select to suspend the execution of a program at a particular location in a callflow. When a breakpoint is encountered during execution of a program, the program suspends and triggers a SUSPEND debug event with BREAKPOINT as the reason.
Toggle Line Breakpoint	Select to set a breakpoint on an executable line of a program.
Toggle Method Breakpoint	Use when working with types that have no source code (binary types). Open the class in the Outline View, and select the method where you want to add a method breakpoint. Select Toggle Method Breakpoint to have a breakpoint appear in the Breakpoints View. If source exists for the class, then a breakpoint also appears in the marker bar in the file's editor for the method that was selected. While the breakpoint is enabled, thread execution suspends when the method is entered, before any line in the method is executed.
Toggle Watchpoint	Appears in GVP Debugging perspective. You must select a Java field object to use this command. Use after you have created a watchpoint on the currently selected field. Whenever that field is accessed or modified, execution will be suspended. If the selected field already has a watchpoint, selecting this command will remove it.

Skip All Breakpoints	Select to mark all breakpoints in the current view as skipped. Breakpoints marked as skipped will not suspend execution.
Remove All Breakpoints	Select to remove all breakpoints from the Breakpoints View.

Configuration Server Menu

URS applications may be developed either:

- With a connection to Configuration Server
- Or in an offline mode, without connecting to Configuration Server

Connect	Select to connect to Configuration Server .
Disconnect	Select to disconnect from Configuration Server

Window Menu

The Window menu allows you to display, hide, and otherwise manipulate the various views, perspectives, and actions in the Workbench. The Window menu contains the following items:

New Window	Opens a new workbench window with the same perspective as the current perspective . The Composer perspective is the default for building your application.
New Editor	Opens an editor based on the currently active editor. It will have the same editor type and input as the original.
Open Perspective	Opens a new perspective in this workbench window
Show View	Displays the selected view in the current perspective. Views support editors and provide alternative presentations as well as ways to navigate the information in your workbench. For example, the Project Explorer and other navigation views display projects and other resources that you are working with. You can configure how views are opened on the Window > Preferences > General > Perspectives preference page.
Customize Perspective	Opens the Customize Perspective dialog box. The Shortcuts tab lets you select shortcuts you want added as cascade items to submenus. The Commands tab lets you select command groups that you want added to the current perspective.
Save Perspective As	Saves the current perspective thereby creating your own custom perspective. You can open more perspectives of this type using the Window > Open Perspective > Other menu item once you have saved a perspective.
Reset Perspective	Changes the layout of the current perspective to its original configuration
Close Perspective	Closes the active perspective
Close All Perspectives	Closes all open perspectives in the workbench window
Navigation	Displays the following submenu and shortcut keys: <ul style="list-style-type: none"> • Show System Menu (Alt+-): Shows the menu that is used for resizing, closing or pinning the current view or editor • Show View Menu (Ctrl+F10): Shows the drop down menu that is available in the toolbar of the active view • Quick Access (Ctrl+3): Shows a listing of available quick access categories

	<ul style="list-style-type: none">• Maximize active view or editor (Ctrl+M): Causes the active part to take up the entire screen, or if it already is, returns it to its previous state• Minimize active view or editor: Causes the active part to be minimized.• Activate Editor (F12): Makes the current editor active• Next Editor (Ctrl+F6): Activates the next open editor in the list of most recently used editors• Previous Editor (Ctrl+Shift+F6): Activates the previous open editor in the list of most recently used editors• Switch to editor (Ctrl+Shift+E): Shows a dialog that allows switching to opened editors. Shows a dialog that allows switching to opened editors.• Next View: Activates the next open view in the list of most recently used views• Previous View (Ctrl+F7): Activates the previous open view in the list of most recently used editors• Next Perspective (Ctrl+F8): Activates the next open perspective in the list of most recently used perspectives• Previous Perspective (Ctrl+Shift+F8): Activates the previous open perspective in the list of most recently used perspectives
Preferences	Opens a dialog box for indicating various Composer preferences. There are a wide variety of preferences for configuring the appearance of Composer and its views, and for customizing the behavior of all tools that are installed in the workbench. See Preferences for Voice Applications and Preferences for Routing Applications .

Help Menu

The Help menu contains the following items:

Welcome	Displays a welcome screen.
Help Contents	Displays the Eclipse help system. Note: The Composer Help, which introduces the Composer Help wiki, is integrated as a workbook within the overall Eclipse Help system.
Search	Opens a help pane where you can enter a search expression and view results.
Dynamic Help	Opens a help pane to show context-sensitive help.
Key Assist (Ctrl+Shift+L)	Opens a help pane with a listing of keyboard shortcuts.
Tips and Tricks	Opens a Tips and Tricks dialog box with a variety of topics:
Cheat Sheets	Opens the Cheat Sheet Selection dialog box with several available Cheat Sheets that lead you through key tasks.
Check for Updates	Currently not used by Composer.
Install New Software	Opens the Install dialog box where you can select or enter a site that has the software you want to install. As described in the Composer 8.1 Deployment Guide , use this menu item to install later versions of Composer. Use the About Eclipse SDK menu item to uninstall the current version of Composer prior to updating to a later version. For another usage example, see the Integrating with Source Control Systems topic, Subversion section.
About Composer	Opens the About Composer dialog box, which displays version, licensing, and Eclipse links. It also contains buttons to access Feature Details , Plug-in Details , and Configuration Details .

Canvas Shortcut Menu

When creating a callflow or workflow in Composer or Composer Design **perspective**, a shortcut menu opens when you right-click inside the **canvas** area. The figure below shows the menu when creating a workflow.

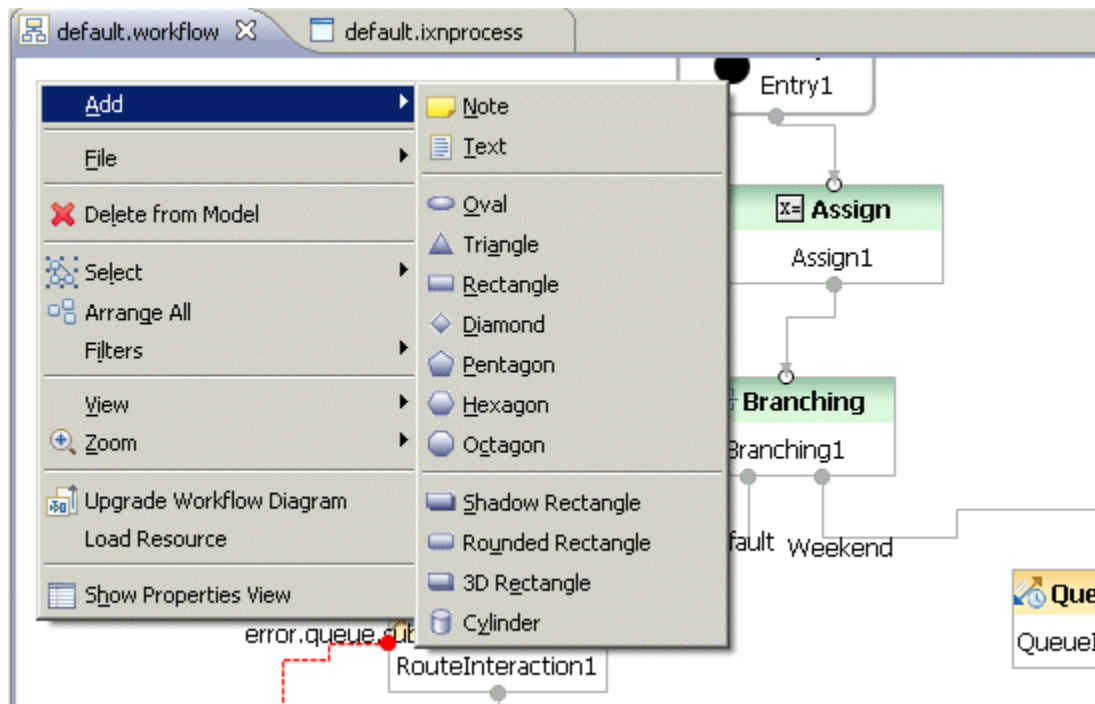

Canvas Menu

The Canvas menu contains the following items:

Add	<p>Allows you to add a note, text, or one of the shapes shown in the figure above.</p> <p>When creating note objects in a diagram there are two ways to create them. After selecting the note tool, you can either click a single point or drag a box to indicate initial size. In the former case, the note will continue to grow horizontally as text is entered. With the latter case, text will automatically wrap text using the input width.</p>
File	<p>Gives the option of printing the diagram or saving it as an image file.</p> <p>Selecting Save as Image opens a dialog box giving the option to save in one of the following formats: GIF, BMP, JPEG, SVG, PNG,</p>

	or PDF. You can also select Export to HTML.
Delete from Model	Deletes the selected block from the workflow.
Select	Allows you to select: <ul style="list-style-type: none"> • All • All Shapes • All Connectors
Arrange All	Use to arrange blocks and connectors in a callflow/workflow in a more orderly fashion. If you don't like the result, select Undo Arrange All from the Edit menu.
Filters	Allows you to show/hide connector labels.
View	Use to view a grid, snap to a grid, view rulers, view page breaks, and re-calculate page breaks.
Zoom	Use to: <ul style="list-style-type: none"> • Zoom In • Zoom Out • Zoom 100% • Zoom to Fit • Fit to Width • Fit to Height • Fit to Selection
Upgrade Workflow Diagram or Upgrade Callflow Diagram	Use to upgrade a previously created diagram to the current version of Composer.
Load Resource	Allows you to browse for/load Resource URIs.
Show Properties View	Shows the Properties view for the selected block or diagram.

Palette Group Menu

When creating a callflow or workflow in Composer or Composer Design **perspective**, a shortcut menu opens when you right-click on a **palette** title bar. The figure below shows an example:

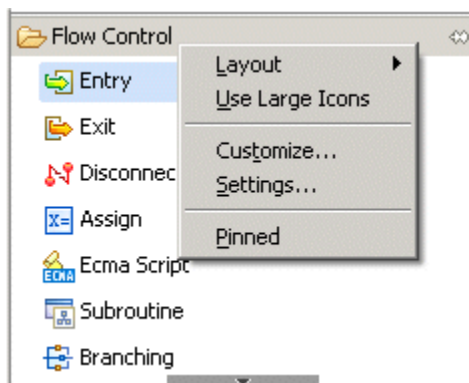

Note: You can customize the palette of diagram building blocks. Right-click a block category (such as Flow Control) and select Customize. You can then hide and unhide blocks.

The Palette Group menu contains the following items:

Layout	Allows you to specify how the blocks in this palette group should be displayed: <ul style="list-style-type: none"> • Columns • List • Icons Only • Detail
Use Large Icons	Allows you to increase the size of the icons representing the callflow or workflow blocks.
Customize	Opens a dialog box where you can change block names and descriptions, hide/unhide blocks from the palette, configure the block drawer to open upon Composer startup, and pin the block drawer open upon Composer startup.
Settings	Opens a dialog box where you can change the font, layout, and palette drawer options.
Pinned	Allows you to prevent a block drawer from closing when you switch to a different palette group.

Composer Toolbars and Views

This section discusses Composer's toolbars.

- [ToolbarsOverview](#)
- [MainToolbar](#)
- [View Toolbars](#)
- [PerspectiveSwitcherToolbar](#)
- [TrimStackToolbar](#)
- [Debugging Toolbar](#)
- [MinimizingandRestoringViews](#)

Toolbars Overview

Composer has a number of toolbars for various purposes:

- [Main Toolbar](#)
- [View Toolbars](#)
- [Perspective Switcher Toolbar](#)
- [Trim Stack Toolbar](#)
- [Debugging Toolbars](#)
- [Minimizing and Restoring Views](#)

Note: To see a tooltip containing the name of a toolbar button (icon), hover the cursor over the button.

Main Toolbar

The Composer main toolbar is shown below (8.1.440 release).

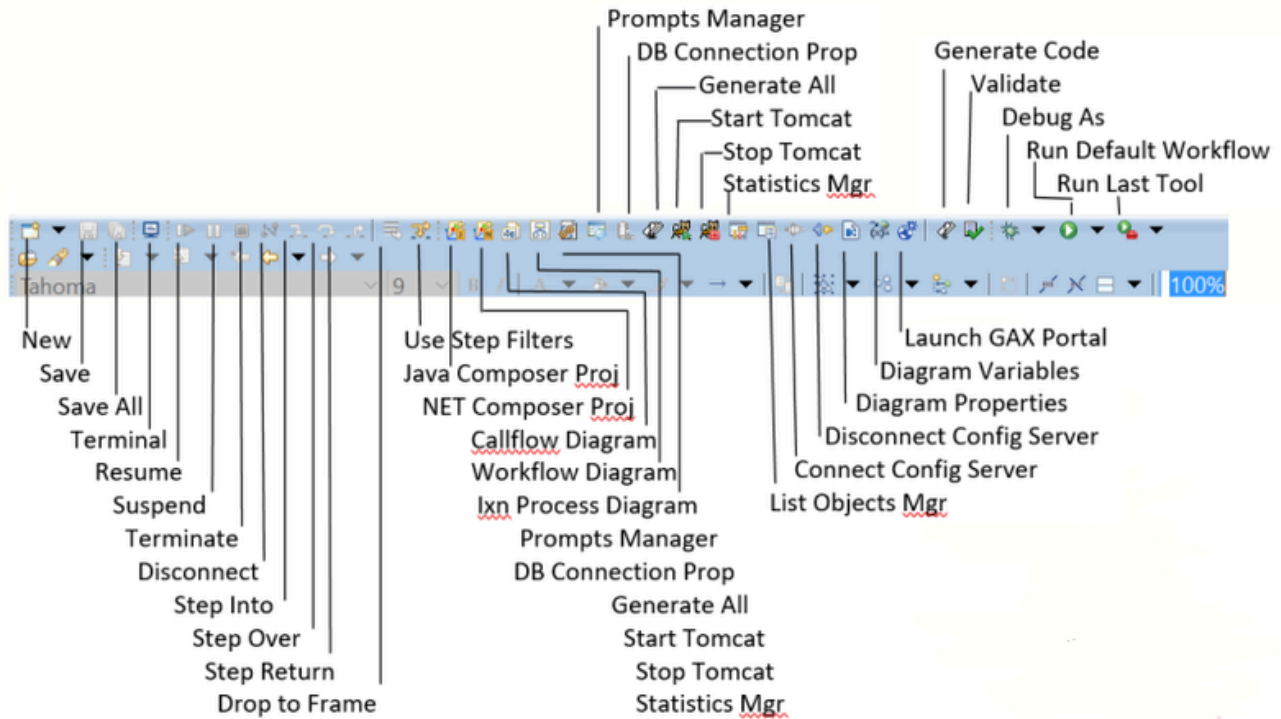









Tip













Buttons on the main toolbar change based on the active **perspective**. Items in the toolbar might also be enabled or disabled based on the state of either the active view or editor. Sections of the main toolbar can be rearranged using the mouse.









Toolbar Buttons











The table below identifies buttons that can appear on the toolbar.



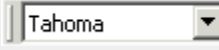

	<p>New</p> <p>Select to create one of the following new resources: Java Composer Project (includes callflows and workflows), .NET Composer Project, Project..., Grammar builder file, VoiceXML file,</p>
--	---

	GrammarXML file, CallControlXML file, Backend JSP file, SCXML file, or Folder, or File. You can also select Example or Other. Note: Before you can create a new file, you must create a project in which to store the file.
	<p>Save</p> <p>Saves the content of the active editor.</p>
	<p>Print</p> <p>Prints the contents of the active editor.</p>
	<p>Debug</p> <p>Re-launches the most recently launched application under debugger control, or launches the selected resource or active editor depending on the launch operation preference settings found on the Run/Debug > Launching preference page. Used for voice applications.</p>
	<p>Run</p> <p>Re-launches the most recently launched application, or launches the selected resource or active editor depending on the launch operation settings found on the Run/Debug > Launching preference page. Click the down arrow to select Run As or Run Configurations. You can also organize favorites.</p>
	<p>Run Last Tool</p> <p>Allows you to quickly repeat the most recent launch in run mode or quickly run the selected resource, if that mode is supported (based on your current launch settings). Click the down arrow to select Run As or bring up the External Tool Configurations dialog box.</p>
	<p>Search</p> <p>Brings up a Search dialog box where you can perform one of the following types of searches: File, Java, Java Script. The General > Search preference page allows you to set preferences for searches.</p>
	<p>Launch GAX Server portal</p> <p>Launches the Genesys Administrator Extension used by the GAX Server (see GAX Server OPM Block). Composer uses the host, port, username, and password used on the GAX Server Preferences page to fetch ARM parameters or audio resource IDs list.</p>
 	<p>Access Project Variables</p> <p>Opens a dialog box where you can set or delete application variables. The appearance of this button changes depending on what type of diagram you are working with. When working with a callflow or workflow, the button appears as shown on the top left. When working with an interaction process diagram, the button appears as shown on the bottom left.</p>

	<p>Create Java Composer Project</p> <p>Brings up a wizard dialog box for creating a new Java Composer Project.</p>
	<p>Create .NET Composer Project</p> <p>Brings up a wizard dialog box for creating a new .NET Composer Project.</p>
	<p>Create New Callflow</p> <p>Brings up a wizard dialog box for creating a main callflow diagram or a sub-callflow diagram.</p>
	<p>Create New Workflow</p> <p>Brings up a wizard dialog box for creating a main workflow diagram or sub-workflow diagram.</p>
	<p>Create New Interaction Process</p> <p>Brings up a wizard dialog box for creating an interaction process diagram.</p>
	<p>Show Properties View</p> <p>Shows the properties of the selected diagram.</p>
	<p>Open the Prompts Manager View</p> <p>Displays the Prompts Manager view in the lower center pane of the Composer main window.</p>
	<p>Open Database Connection Properties</p> <p>Opens the Connection Profiles tab where you can define a database connection profile and test the connection. This button becomes enabled when you select the connection.properties file in the Project db folder.</p>
	<p>Generate All</p> <p>Opens the Generate all dialog box, which lets you create properly formatted VoiceXML or SCXML files for all callflow and/or workflows in the Project.</p>
	<p>Start Tomcat</p> <p>Starts the Tomcat web server, which can be used for testing and deployment. If Tomcat has already started, displays a message to this effect.</p>
	<p>Stop Tomcat</p> <p>Stops the Tomcat web server.</p>
	<p>Connect to Configuration Server</p> <p>Opens a dialog box where you can connect to Configuration Server. Used for routing applications. When you set up your Configuration Database (Configuration Server), you define</p>

	<p>certain database objects, such as agents (Persons), Agent Groups, Skills, and so on. These objects can be defined in Configuration Manager or in Genesys Administrator. When you use Composer to create SCXML routing strategies executed by Orchestration Server (and Universal Routing Server), there is a button to connect to Configuration Server. When creating a routing strategy in Composer, those Configuration Database objects will be available in the Composer routing strategy building blocks that use them. For example, you might be creating a routing strategy that routes to an Agent Group and using Composer's Target block. The Agent Group you defined in the Configuration Database would be available for selection in the Target block.</p>
	<p>Disconnect from Configuration Server</p> <p>Disconnects from Configuration Server.</p>
	<p>Statistics Manager</p> <p>Opens the Statistics Manager view for working with Universal Routing Server predefined statistics. Used for routing applications.</p>
	<p>List Objects Manager</p> <p>Opens the List Object Manager view, which allows you to create List Objects in Configuration Server. Use for creating parameterized applications. This provides System Administrators with the control to configure and change values from inside Configuration Server. Used for routing applications.</p>
	<p>Publish active interaction process diagram to Configuration Server</p> <p>If an interaction process diagram is selected, this toolbar button appears.</p>
	<p>Generate Code</p> <p>Creates a properly-formatted VoiceXML file from a callflow diagram or a SCXML file from a workflow diagram. Static pages (pure VXML or SCXML code) are generated in the src-gen folder of the Composer Project.</p>
	<p>Validate</p> <p>Checks your diagram files and other source files for completeness and accuracy. In the case of errors, the Problems view becomes visible and error markers are put on the blocks that contain errors. Double clicking on an error in the Problems view will take you to the corresponding blocks that contain the errors. Review each of the errors and do the fixes, then validate again.</p>
	<p>Next Annotation</p> <p>Selects the next annotation. Supported in the Java editor.</p>
	<p>Previous Annotation</p> <p>Selects the previous annotation. Supported in the Java editor.</p>

	<p>Last Edit Location</p> <p>Reveals the location where the last edit occurred.</p>
	<p>Back To</p> <p>Reveals the previous editor location in the location history.</p>
	<p>Forward To</p> <p>Reveals the next editor location in the location history.</p>
	<p>Turn Grammar Constraints Off</p> <p>When editing an XML file that has a set of constraints or rules defined by a DTD or an XML schema, you can turn the constraints on and off to provide flexibility in the way you edit, but still maintain the validity of the document periodically. When the constraints are turned on, and you are working in the Design view, the XML editor prevents you from inserting elements, attributes, or attribute values not permitted by the rules of the XML schema or DTD, and from removing necessary or predefined sets of tags and values.</p>
	<p>Reload Dependencies</p> <p>If you make changes to a DTD file or XML schema associated with an XML file (that is currently open), click to update the XML file with these changes. The changes will be reflected in the guided editing mechanisms available in the editor, such as content assist.</p>
	<p>Expand All</p> <p>Select to expand all of the items in the Breakpoints view.</p>
	<p>Collapse All</p> <p>Select to collapse all of the current elements in the view.</p>
	<p>Font Style</p> <p>Allows you to change the font style of the selected text.</p>
	<p>Font Size</p> <p>Allows you to change the font size of the selected text.</p>
	<p>Bold Font Style</p> <p>Allows you to bold the selected text.</p>
	<p>Italic Font Style</p> <p>Allows you to change the selected text to italics.</p>
	<p>Font Color</p> <p>Allows you to change the font color of the select text.</p>

	<p>Fill Color</p> <p>Allows you to change the fill color of the selected object.</p>
	<p>Line Color</p> <p>Allows you to change the color of the selected line.</p>
	<p>Line Style</p> <p>Allows you to change the style of the selected line.</p>
	<p>Apply Appearance Properties</p> <p>Allows you to apply the applicable appearance properties of the first application shape to the other selected shapes.</p>
	<p>Select All</p> <p>Selects all objects in the diagram.</p>
	<p>Arrange All</p> <p>Arranges all or only the selected objects in the diagram.</p>
	<p>Align</p> <p>Aligns the selected objects in the callflow diagram: left, right, center, top, middle, bottom.</p>
	<p>Auto Size</p> <p>Allows you to change the size of the selected object.</p>
	<p>All Connector Labels</p> <p>Shows labels for all connector lines in the diagram.</p>
	<p>No Connector Labels</p> <p>Hides labels for all connector lines in the diagram.</p>
	<p>Show/Hide Compartment</p> <p>Shows or hides composite attributes within an editor, which can optionally be collapsed or expanded.</p>
	<p>Magnification</p> <p>Allows you to zoom and out of the current view, as well as to change the magnification from 5% to 400%. You can also fit to height, width, or selection.</p>

View Toolbars



The title bar of a view contains a toolbar. This topic describes the following view toolbars:

Project Explorer

The Project Explorer toolbar is shown below.



Each toolbar button is identified in the table below.

	<p>Collapse All</p> <p>Select to collapse all of the current elements in the view.</p>
	<p>Link Open Editors</p> <p>When you have multiple files open for editing, select to bring an open file to the foreground (make its editor session the active editor) every time you select that open file in one of the navigation views.</p>
	<p>View Menu</p> <p>Select to show additional actions for this view.</p> <ul style="list-style-type: none"> • Top Level Elements. Select from Projects or Working Sets (see below). • Folder Presentation. Select from Flat or Hierarchical. • Working Set. Select from Window Working Sets, No Working Sets, Selected Working Sets. Working sets group elements for display in views or for operations on a set of elements. The navigation views use working sets to restrict the set of resources that are displayed. If a working set is selected in the navigator, only resources, children of resources, and parents of resources contained in the working set are shown. • Deselect Working Set. Deselects the active working sets. All elements are shown after

invoking this action

- Edit Active Working Set. Opens the Edit Working Set wizard to edit the currently active working set.
- Package Presentation. Select from Flat or Hierarchical.
- Customize View. Allows you to filter the Project Explorer view to hide projects, folders, or files that you do not want to see.
- Link Editor. Brings an open file to the foreground (makes its editor session the active editor) every time you select that open file in one of the navigation views.

Bookmarks View

The Bookmarks view is shown below.

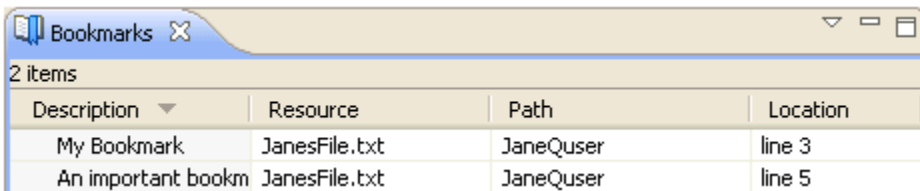

Description	Resource	Path	Location
My Bookmark	JanesFile.txt	JaneQuser	line 3
An important bookm	JanesFile.txt	JaneQuser	line 5

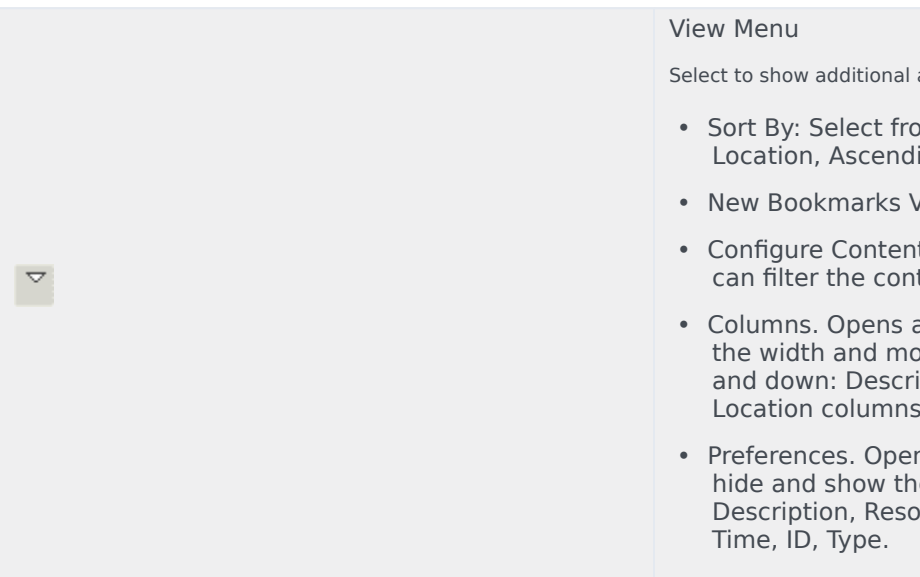

Each view button is identified in the table below.



View Menu

Select to show additional actions for this view.

- Sort By: Select from Description, Resource, Path, Location, Ascending.
- New Bookmarks View.
- Configure Contents. Opens a window where you can filter the contents of the Bookmarks tab.
- Columns. Opens a dialog box where you can set the width and move the following columns up and down: Description, Resource Path, and Location columns.
- Preferences. Opens a dialog box where you can hide and show the following columns: Description, Resource, Path, Location, Creation Time, ID, Type.



	<p>Minimize</p> <p>Minimizes the Bookmarks tab.</p>
	<p>Maximize</p> <p>Maximizes the Bookmarks tab.</p>

Canvas View

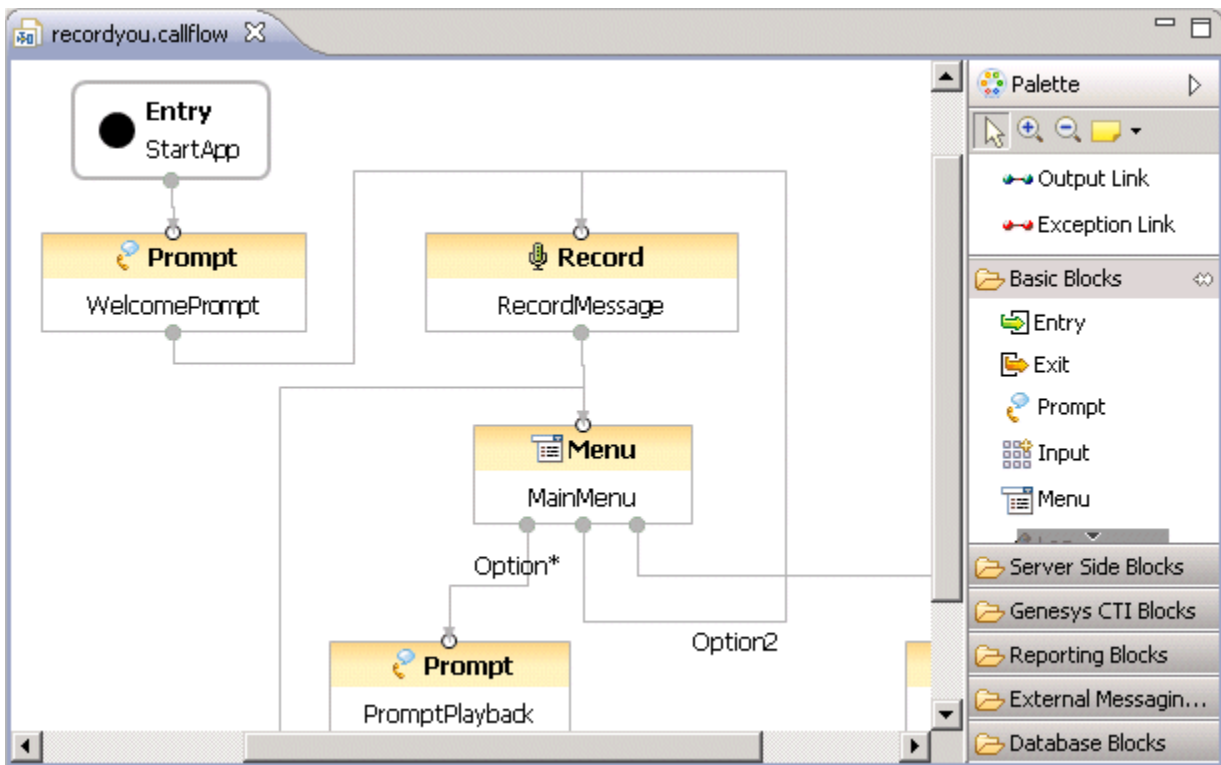
The canvas is where you create callflows for your voice applications and workflows for your routing applications. The Canvas view toolbar is shown below in the upper-right.



Each view button is identified in the table below.



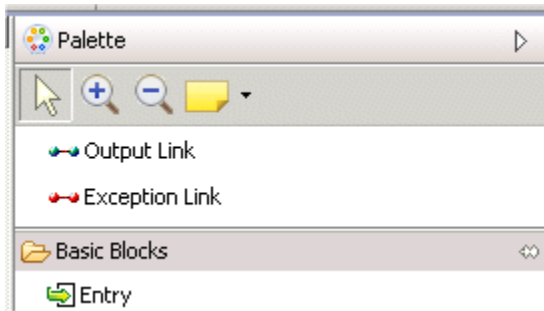

	<p>Minimize</p> <p>Minimizes the Canvas area.</p>
	<p>Maximize</p> <p>Maximizes the Canvas area.</p>

Palette View

The Palette contains link tools as well as various types of blocks. To create callflow diagrams, the block categories are: **Basic Blocks**, **Server Side Blocks**, **CTI Blocks**, **Reporting Blocks**, **External Message Blocks**, **Database Blocks**, and **Context Services Blocks**. To create workflow diagrams, the block categories are: **Flow Control Blocks**, **Routing Blocks**, **Voice Treatment Blocks**, **Server Side Blocks**, **eService Blocks**, and **Context Services Blocks**. The Palette view toolbar is shown below.



Each toolbar button is identified in the table below.





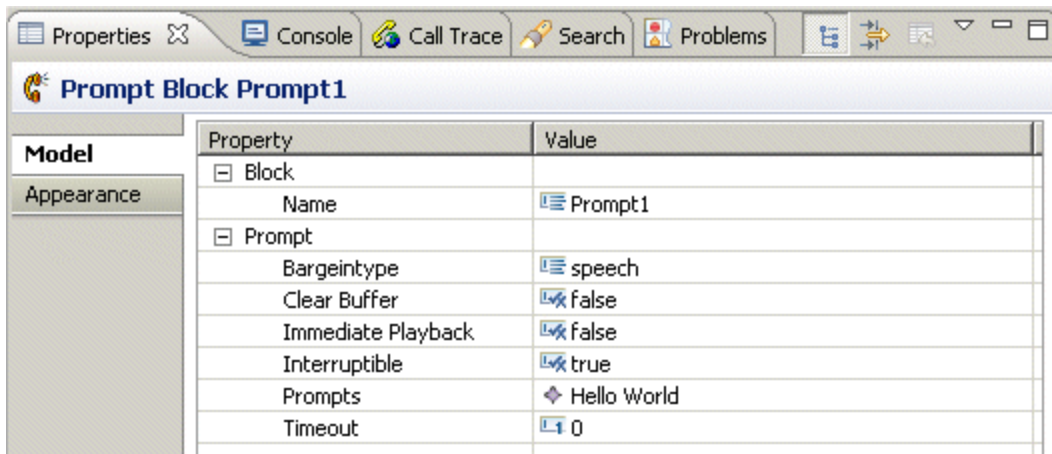

	<p>Select</p> <p>Use to select a block for a callflow or workflow.</p>
	<p>Zoom In</p> <p>Click left to zoom in, Shift + left click to zoom out, drag to zoom to selection.</p>
	<p>Zoom Out</p> <p>Click left to zoom out, Shift + left click to zoom in.</p>
	<p>Create Note</p> <p>Click to create a note, text document, or note attachment. When creating note objects in a diagram there are two ways to create them. After selecting the note tool, you can either click a single point or drag a box to indicate initial size. In the former case, the note will continue to grow horizontally as text is entered. With the latter case, text will automatically wrap text using the input width.</p>

Properties View

The Properties view shows the properties for a selected block and allows you to set/modify them. An example Properties view and toolbar is shown below.





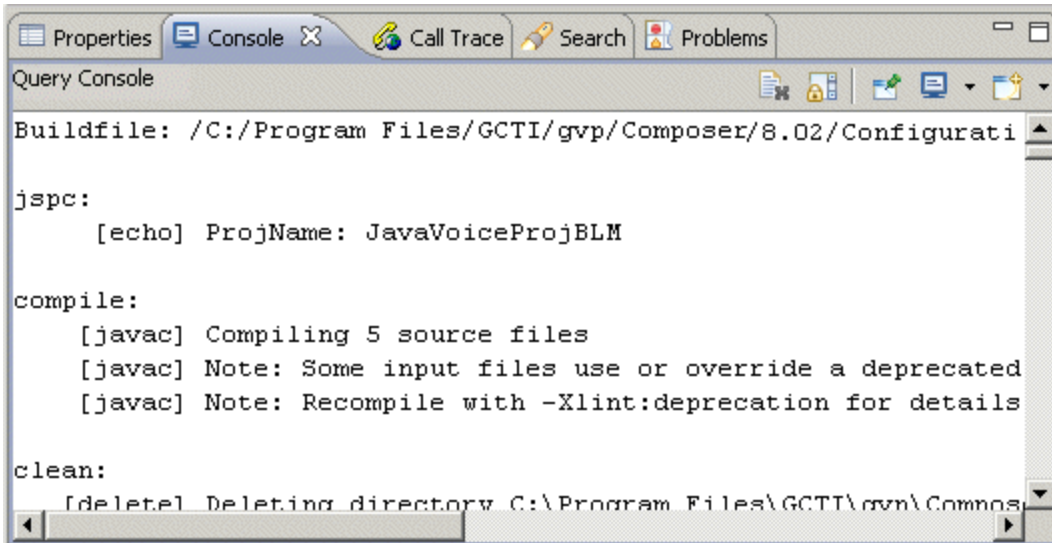

Each toolbar button is identified in the table below.

	<p>Show Categories</p> <p>If enabled, method, field and type labels contain the categories specified in their block properties</p>
	<p>Show Advanced Properties</p> <p>If enabled, the Properties view shows advanced properties.</p>
	<p>Restore Default Value</p> <p>Use after changing a value in the Properties view to revert back to the default value.</p>
	<p>View Menu</p> <p>Select to show additional actions for this view: Show Categories, Show Advanced Properties, and Columns.</p>
	<p>Minimize</p> <p>Minimizes the Properties tab.</p>
	<p>Maximize</p> <p>Maximizes the Properties tab.</p>

You can change settings for consoles on the Window Preferences Run/Debug Console page. An example Query Console view is shown below.



Each toolbar button is identified in the table below.



	Clear Console Clears the currently active console.
	Scroll Lock Changes if scroll lock should be enabled or not in the current console.
	Pin Console Pins the current console to remain on top of all other consoles.
	Display Selected Console Opens a listing of current consoles and allows you to select which one you would like to see.
	Open Console Opens a new console of the selected type.

Call Trace View

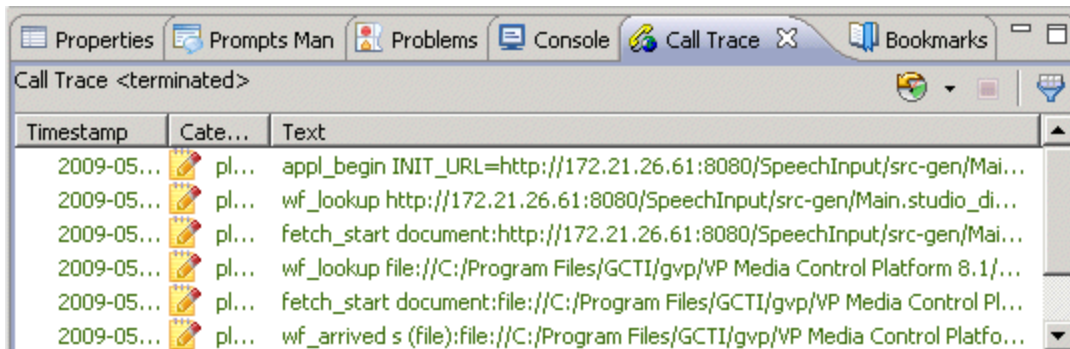
The Call Trace view displays metrics which describe the events occurring in the application, such as recognition events, audio playback, user input, errors and warnings, and application output. An example Call Trace view and Toolbar are shown below.



Each toolbar button is identified in the table below.



	<p>Call Trace History</p> <p>Lists past calls. Once you select a past call, shows call trace history for that past call.</p>
	<p>Terminate</p> <p>Terminates the process that is associated with the current Process Console.</p>
	<p>Filter Metrics</p> <p>Brings up the Filter Metrics dialog box where you can select the following filters: Platform actions, User input, Application output, Document flow, Errors and warnings.</p>

Search View

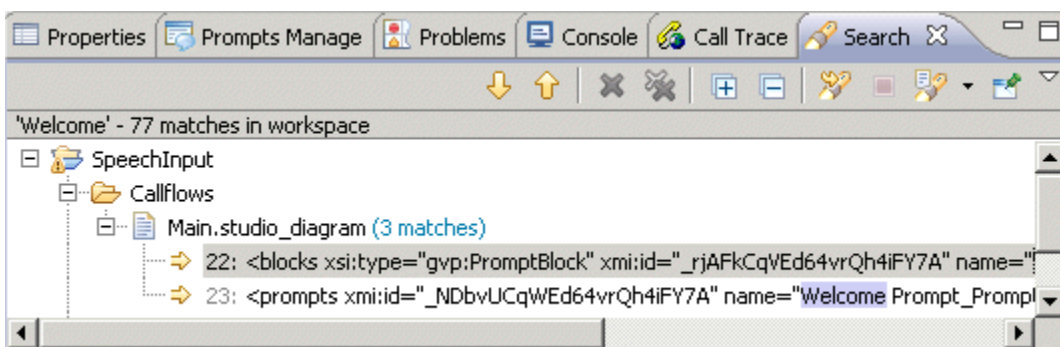
The search dialog lets you perform text string, File, Java, and JavaScript searches. When you first click the Search tab, there is a link to bring up the Search dialog box. The figure below shows the results of an example search and the toolbar.



Each toolbar button is identified in the table below.

	Show Next Match Shows the next items that meets the search criteria.
	Show Previous Match Shows the previous item that met the search criteria.
	Remove Selected Matches Removes matched items that you have selected from the results .
	Remove All Matches Removes all matches from the results.
	Expand All Select to expand all of the current elements in the view.
	Collapse All Select to collapse all of the current elements in the view.
	Run Current Search Again Repeats the search with currently-defined parameters.
	Cancel Current Search Cancels the current search.
	Show Previous Searches Displays a list of previous searches.
	Pin the Search View Pins the current search view to remain on top of all other views.
	View Menu Select from the following: Show as List, Show as tree, Filters, Preferences.



As you work with resources in the workbench, various builders may automatically log problems, errors, or warnings in the Problems view. For example, when you save a Java source file that contains syntax errors, those will be logged in the Problems view. When you double-click the icon for a problem, error, or warning, the associated block is highlighted in the canvas area. Also see topics [Diagram Validation](#) and [Validating a Single Flow Diagram](#).

Problems View

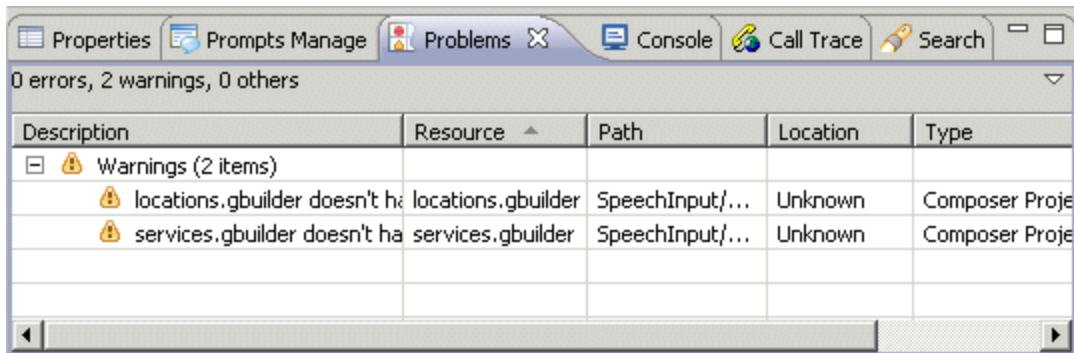
An example Problems view with toolbar is shown below.



Each toolbar button is identified in the table below.

	<p>View Menu</p> <p>Select to show additional actions for this view. Show: All Errors, Warning on Selection, Show All. Group By: Java Problem Type, Type, JavaScript Problem Type, Severity, None. Sort by: Description, Resource, Path, Location, Type, Ascending New Problems View Configure Contents. Opens a window where you can filter the contents of the Problems tab. Columns. Opens a dialog box where you can set the width and move the following columns up and down: Description, Resource Path, and Location. Preferences. Opens a dialog box where you can hide and show the following columns: Description, Resource, Path, Location, Creation Time, ID, Type.</p>
	<p>Minimize</p> <p>Minimizes the Problems tab.</p>
	<p>Maximize</p> <p>Maximizes the Problems tab.</p>

Statistics Manager View

The Statistics Manager view lets you easily create, delete, and organize created statistics into folders.

The screenshot shows the Statistics Manager toolbar with a search filter set to "type filter text". Below the search bar is a table listing predefined statistics.

Name	Type	Category	Subject	Filter	Access
CallsWaiting	Predefined				
InVQWaitTime	Predefined				
PositionInQueue	Predefined				
RStatCallsInQueue	Predefined				
RStatCallsInTransition	Predefined				
RStatCost	Predefined				
RStatExpectedLBEWTLAA	Predefined				
RStatExpectedLoadBalance	Predefined				

Each toolbar button is identified in the table below.

	<p>Add New Folder</p> <p>You have the option of creating folders to organize statistics that you create. Click this button to create a new folder.</p>
	<p>Add New Statistic</p> <p>To build a new statistic, select a folder and click this button to bring up Statistics Builder.</p>
	<p>Delete Selected Item</p> <p>To delete a statistic that you have created, select the statistic and click this button to delete.</p>

Help View

The Help view shows the following toolbar after selecting Search from the Help menu.

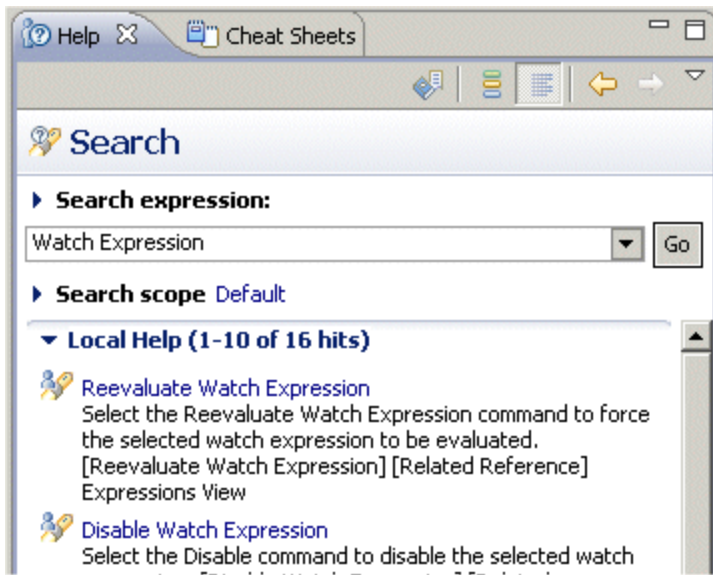







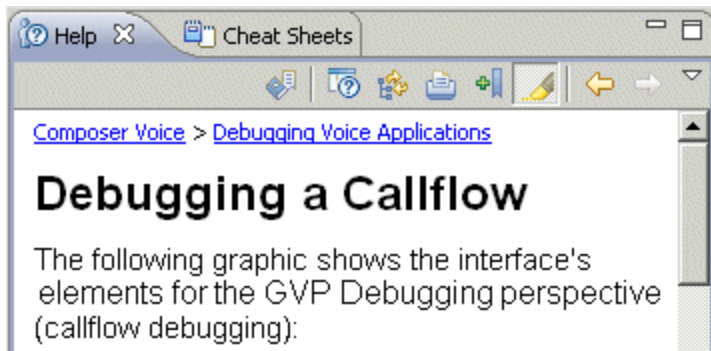

Each toolbar button in the Help view is identified in the table below.

	Show All Topics Select to display all available Help topics.
	Show Result Categories Select to display the categories for the Help results.
	Show Result Descriptions Select to display the descriptions of the Help topics.
	Back Move back through topics.
	Forward Move forward to next topic.

Once you select a topic, the toolbar changes as shown below.



Each toolbar button is identified in the table below.

	Show All Topics Select to display all available Help topics.
	Show in External Window Select to display the results in an external window.
	Show in All Topics Select to display the results in all topics.
	Print Select to print the results/topic.
	Bookmark Select to bookmark the results/topic
	Highlight Search Term Select to highlight a search term.
	Back Move back through results.
	Forward Move forward to next result.

Perspective Switcher Toolbar

Perspectives are task-oriented layouts for organizing the views and windows in your workbench. The Perspective Switcher Toolbar allows quick access to perspectives that are currently open.

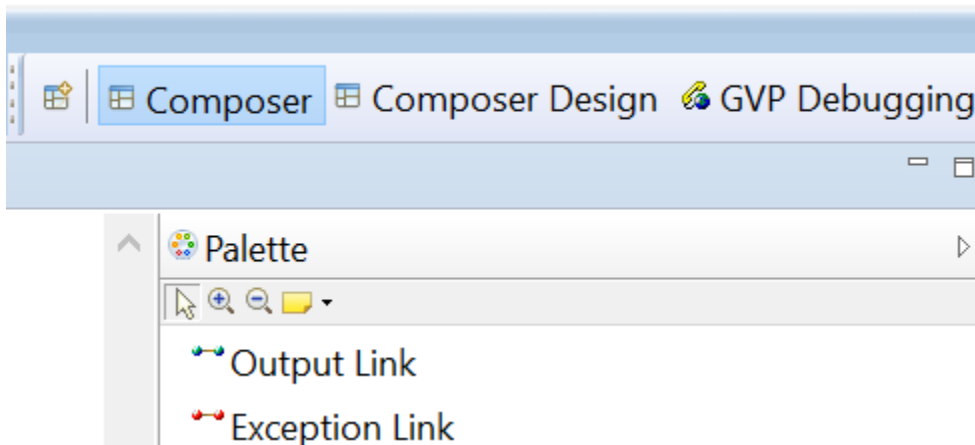

Open Perspective Button

An **Open Perspective** button  (displaying all Eclipse perspectives) may be located at the start or end of the Perspective Switcher toolbar, depending on your version of Eclipse.

Perspective Switcher Toolbar

The Perspective Switcher Toolbar is normally positioned below the main toolbar (top-left), but you can also position it vertically on the left-hand side of the workbench.

Shortcut Menu for Perspective Buttons

Right-clicking the button for an active perspective opens a shortcut menu. The first three entries in the table below do not appear if the perspective is not selected.

Customize	Opens the customize perspective dialog box.
Save As	Opens a dialog box for saving a customize perspective. Once saved, the customize perspective appears in the list that opens when

	you click the Open Perspective button.
Reset	Resets the changes you made to a perspective.
Close	Removes the button for the perspective.
Dock On	Allows you to dock the perspective button: Top Right, Top Left, or Left (left-hand side of work bench).
Show Text	Toggles between an icon and text on the perspective button.

Trimstack Toolar

Minimizing a view stack will also produce a toolbar in the trim at the outer edge of the workbench window (a Trim Stack). This bar will contain a button for each of the views in the stack. Clicking on one of these icons will result in the view being displayed as an overlay onto the existing presentation. This is an example of a Trim Stack Toolbar containing buttons for Restore, Properties, Problems, Console, Call Trace, and Prompts Manager views:



The first button is Restore , which restores the normal view.

Debugging Toolbars

In **GVP** and **ORS** Debugging perspectives, the first pane contains Debug and Navigator views. The second pane contains views for Variables, Breakpoints, and Expressions. A GVP example is shown below.

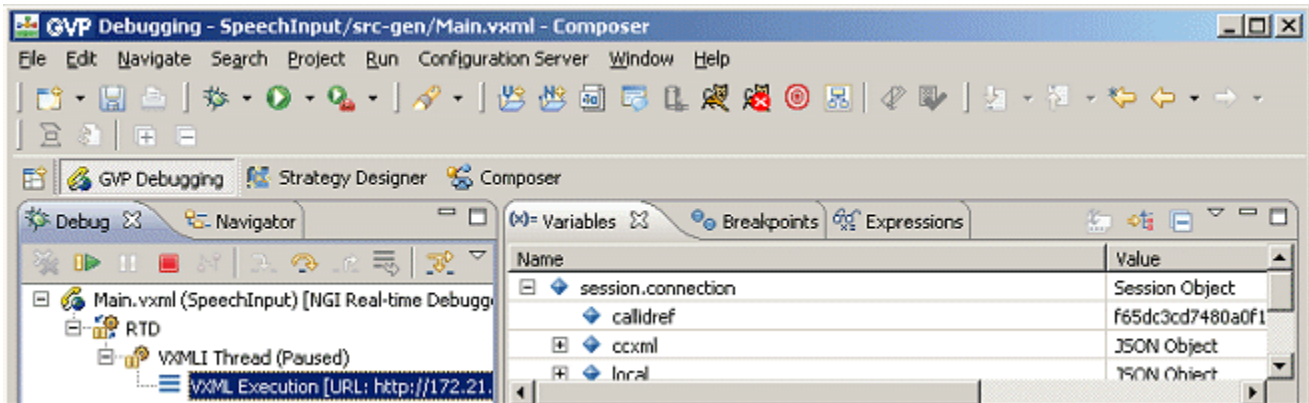





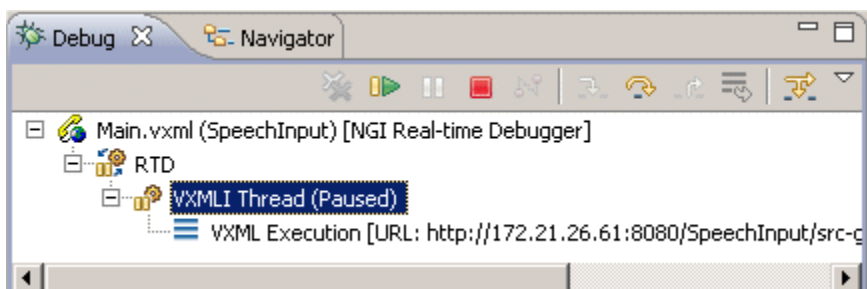





Debug View

The Debug view shows the name of the callflow or workflow diagram being debugged, as well as the status of the debug progress or result.



Each toolbar button is identified in the table below.

	<p>Remove All Terminated Launches</p> <p>Select to clear the Debug view of all terminated launches.</p>
	<p>Resume</p> <p>Select to resume the execution of the currently suspended debug target.</p>

	<p>Suspend</p> <p>[Not supported in Composer]</p>
	<p>Terminate</p> <p>Select to terminate the launch associated with the selected debug target. Once a launch is terminated it can be automatically removed from the Debug view. When using the ORS Debugger, Terminate means that the session in ORS will end along with the debugging session.</p>
	<p>Disconnect</p> <p>Not supported for the GVP Debugger. When using the ORS Debugger, Disconnect means that the debugging session ends, but ORS will continue executing the SCXML.</p>
	<p>Step Into</p> <p>Disabled for both routing and voice applications.</p>
	<p>Step Over</p> <p>Step Over is the only way to step for both routing and voice applications. Select to step over the next method call (without entering it) at the currently executing line of code. Even though the method is never stepped into, the method will be executed normally.</p>
	<p>Step Return</p> <p>[Not supported in Composer]</p>
	<p>Drop to Frame</p> <p>[Not supported in Composer]</p>
	<p>Use Step Filters</p> <p>[Not supported in Composer]</p>
	<p>View Menu</p> <p>Select from the following:</p> <ul style="list-style-type: none"> • View Management • Java (then select from: Show Monitors, Show System Threads, Show Qualified Names, Show Thread Groups)

Navigator View

The Navigator view shows the same Project folder structure shown in the Project Explorer window of the Composer perspective.

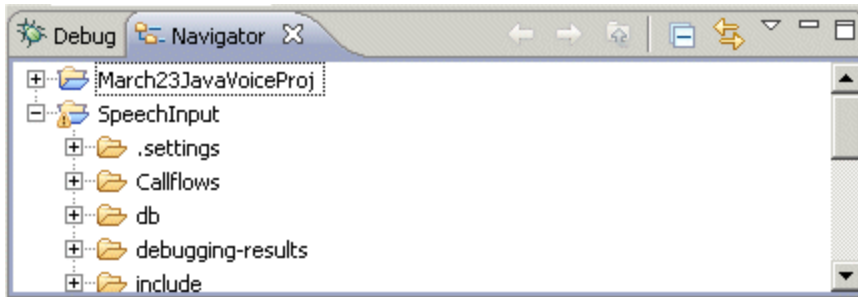

Each toolbar button on the Navigator toolbar is identified in the table below.

	<p>Back</p> <p>Moves back.</p>
	<p>Forward</p> <p>Moves forward.</p>
	<p>Up</p> <p>Navigate up one level in the hierarchy</p>
	<p>Collapse All</p> <p>Select to collapse all of the current elements in the view.</p>
	<p>Link Open Editors</p> <p>When you have multiple files open for editing, select to bring an open file to the foreground (make its editor session the active editor) every time you select that open file in one of the navigation views.</p>
	<p>View Menu</p> <p>Select to show additional actions for this view.</p> <ul style="list-style-type: none"> • Select Working Set. Working sets group elements for display in views or for operations on a set of elements. The navigation views use working sets to restrict the set of resources that are displayed. If a working set is selected in the navigator, only resources, children of resources, and parents of resources contained in the working set are shown. • Deselect Working Set. Deselects the active working sets. All elements are shown after invoking this action. • Edit Active Working Set. Opens the Edit Working Set wizard to edit the currently active working set. • Sort (by name or type).



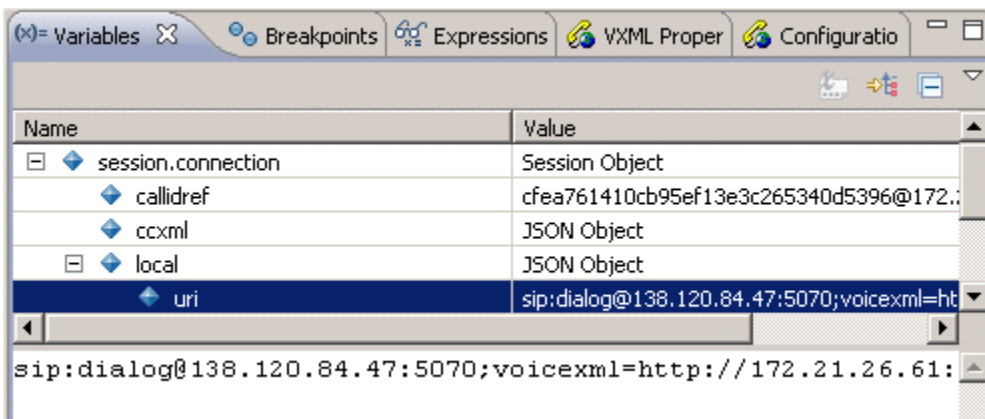

	<ul style="list-style-type: none"> • Filters (class, JETEmitters, general, or *). • Link with Editor. Brings an open file to the foreground (makes its editor session the active editor) every time you select that open file in one of the navigation views.
--	---

Variables View

The Variables view displays information about the variables associated with the stack frame selected in the Debug view. When debugging a Java program, variables can be selected to have more detailed information as displayed below. In addition, Java objects can be expanded to show the fields that a variable contains.



Each toolbar button in the Variables view is identified in the table below.











	<p>Show Type Names</p> <p>Select to change if type names should be shown in the view or not. Unavailable when columns are displayed. Hint: Select Layout from View menu and de-select Show Columns.</p>
	<p>Show Logical Structure</p> <p>Select to change if logical structures should be shown in the view or not.</p>
	<p>Collapse All</p> <p>Select to collapse all the currently expanded variables.</p>
	<p>View Menu</p> <p>Select from the following:</p> <ul style="list-style-type: none"> • Layout: Vertical View Orientation, Horizontal

	<p>View Orientation, Variables view Only, Show Columns, Select Columns.</p> <ul style="list-style-type: none"> • Java: Show Constants, Show Static Variables, Show Qualified Names, Show Null Array Entries, Show References, Java Preferences.
--	--

Breakpoints View

The Breakpoints view and toolbar manage breakpoints within a debugging session.

Each toolbar button in the Breakpoints view is identified in the table below.

	<p>Remove Selected Breakpoints</p> <p>Select to clear all selected breakpoints.</p>
	<p>Remove All Breakpoints</p> <p>Select to clear all breakpoints.</p>
	<p>Show Breakpoints Supported by Selected Targets</p> <p>Select to show all breakpoints supported by the selected targets.</p>
	<p>Go To File For Breakpoint</p> <p>[Not supported in Composer]</p>
	<p>Skip All Breakpoints</p> <p>Select to skip over all breakpoints.</p>
	<p>Create URL Breakpoint</p> <p>Select to create a breakpoint that uses a URL.</p>
	<p>Expand All</p> <p>Select to expand all the current breakpoints.</p>
	<p>Collapse All</p> <p>Select to collapse all the current breakpoints.</p>
	<p>Link With Debug View</p> <p>[Not supported in Composer]</p>
	<p>Add Java Exception Breakpoint</p>

	<p>Select to open a dialog box where you can:</p> <ul style="list-style-type: none"> • Type a string that is contained in the name of the exception you want to add. You can use wildcards as needed ("* " for any string and "? " for any character). • Select the exception types you want to add. • Select Caught and Uncaught as needed to indicate on which exception type you want to suspend the program. <p>[This option is not relevant to GVP Debugging in Composer.]</p>
	<p>View Menu</p> <p>Select from the following:</p> <ul style="list-style-type: none"> • Group By: Breakpoints, Breakpoint Types, Breakpoint Working Sets, Files, Projects, Resource Working Sets, Advanced... • Default Working Set • Deselect Default Working Set • Working Sets • Show Qualified Names





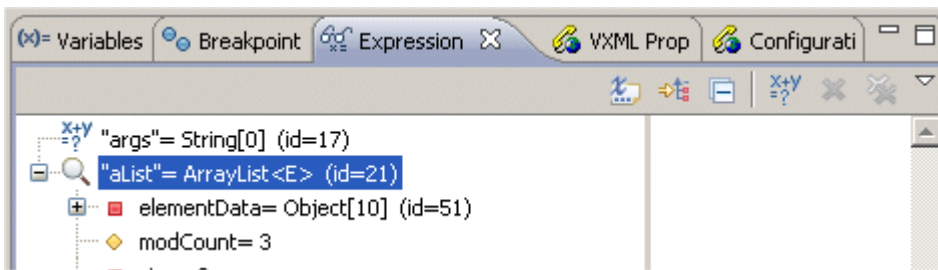

Expressions View

Use the Expressions view to inspect data from a stack frame of a suspended thread, and other places.



Each toolbar button in the Expressions view is identified in the table below.

	<p>Show Type Names</p> <p>Select to change if type names should be shown in the view or not. Unavailable when columns are displayed. Hint: Select Layout from View menu and de-select Show Columns.</p>
---	--

	Show Logical Structure Select to change if logical structures should be shown in the view or not.
	Collapse All Select to collapse all the currently expanded expressions.
	Create a New Watch Expression Select to open the Create New Expression dialog box, which allows you to create a new watch expression based on the selected variable and add it to the Expressions View.
	Remove Selected Expressions Select to remove the selected expressions.
	Remove All Expressions Select to remove all expressions.
	View Menu Select from the following: <ul style="list-style-type: none">• Layout: Vertical View Orientation, Horizontal View Orientation, Expressions View Only.• Java: Show Constants, Show Static Variables, Show Qualified Names, Show Null Array Entries, Show References, Java Preferences.

Minimizing and Restoring Views

Panes in the Composer window contain various views. Each view has its own tab. To minimize a pane containing views:

- Click the  button to minimize the pane. This causes the views to appear in a toolbar (**trim stack toolbar**). The toolbar appears in close proximity to where the pane was located.

The toolbar could be on the side or at the bottom of the Composer window depending on the selected perspective. For example, assume you are editing a file in Composer Design perspective and minimize the pane below, which contains Properties, Prompts Manager, Problems, Console, Call Trace, and Bookmark views. In this case, the minimization causes a toolbar to appear at the bottom of the Composer window. Depending on your screen, you may have to maximize the entire Composer window in order to see this toolbar.

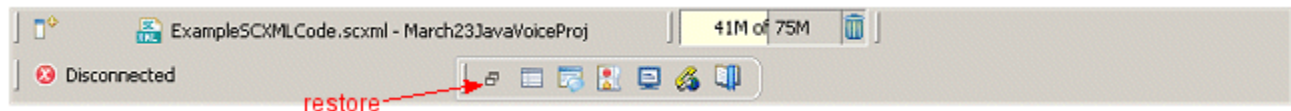

To restore a minimized view:

- Click the  button to restore all minimize views.
- Click a single view button to restore an individual view.

Restore All Views

Select **Window > Reset Perspective**. If the desired view does not appear, select **Window > Show View**.

Show Advanced Properties

When creating a diagram in Composer perspective, this button appears on the right side of the Composer GUI, between the palette of blocks and the Properties view.



Certain block properties are hidden by default from the Palette. If you have permission you can use the Show Advanced Properties button to display/hide these properties.

Moving the Location of a View

To move a view to another location, hold down the cursor next to the view name until you see a red circle with a slash in the middle. Keep holding down the cursor, move the view to the desired location, and release the cursor.

Strategy Manager View

The Strategy Manager view lists all Routing Points from the connected Configuration Server. This view provides options to directly deploy Composer generated strategies to routing points in Configuration Server.

To access the Strategy Manager view, select the **Strategy Manager** icon from the toolbar. The Strategy Manager view is displayed.

Name	Number	Script
2223_SIP_Switch	2223	script:BasicIVR_V0.BasicIVR.Workflow1
3094140_SIP_Switch	3094140	
3094141_SIP_Switch	3094141	script:RoadAssistance
3094142_SIP_Switch	3094142	Personal Assistant-Voicemail
6504663243_SIP_Switch	6504663243	script:BasicIVR.BasicIVR.Workflow1_Basic IVR
6504663244_SIP_Switch	6504663244	http://localhost/gms_demo/inbound.scxml
6504663247_SIP_Switch	6504663247	script:GenesysOne_Voice.default.GenesysOne_Voice
8000_S4B_Switch	8000	
8000_SIP_Switch	8000	SIP_Switch_8000-Router Controlled Callflow
8001_SIP_Switch	8001	SIP_Switch_8001-Route To Agent
8002_SIP_Switch	8002	SIP_Switch_8002- Premier Financial Services
8003_SIP_Switch	8003	SIP_Switch_8003_8004-iCFD
8004_SIP_Switch	8004	SIP_Switch_8003_8004-iCFD
8005_SIP_Switch	8005	
8006_SIP_Switch	8006	sim_Gi2
8007_SIP_Switch	8007	Nov2013_WFMRouting
8008_SIP_Switch	8008	GVP_Behind_CTIC
8009_SIP_Switch	8009	SIP_Switch_8009 - Outbound
8011_SIP_Switch	8011	script:Java_refactor_32.default.defaultWorkflow
8012_SIP_Switch	8012	Personal Assistant-Voicemail
8013_SIP_Switch	8013	SIP_Server_8013_Route_To_Outbound_Agents
8014_SIP_Switch	8014	Simulator - 2206 - Workforce Predictive Route
8015_SIP_Switch	8015	Transfer_to_GAS_agent
8016_SIP_Switch	8016	Route_to_GAS_agent
8017_SIP_Switch	8017	SIP_Switch_8017-Chat_To_Video
8018_Story_VM	8018	script:8018:101
8020_SIP_Switch	8020	script:V_DeployScript_RP_J.default.defaultWorkflow
8021_SIP_Switch	8021	Send_Email

Important

This view is available from version 8.1.450.33.

To deploy a script to a routing point,

- Select the required routing point and right-click **Deploy Script**. The **Please select script for <specified routing point>** dialog is displayed.
- Select the required script and click **OK**. The script is deployed.

To undeploy a script from a routing point,

- Select the required routing point and right-click **UnDeploy Script**. A confirmation prompt is displayed.
- Click **Yes**. The script is undeployed.

Voice Applications and Callflows

This section contains the following:

- [Callflow Post Installation](#)
- [What is GVP and How Do Voice Applications Work?](#)
- [CallflowBlocks](#)
- [Variables in Callflows](#)
- [HelloWorldSample](#)
- [Creating Voice Applications for GVP](#)
- [Creating CCXML Applications](#)
- [Creating VXML Applications](#)
- [Working with Java Composer Projects](#)
- [Working with .NET Composer Projects](#)
- [VXML Properties](#)

Getting Started with Voice Applications

This section contains the following topics:

- [Callflow Post Installation Configuration](#)
- [Working with Java Composer Projects](#)
- [Working with .NET Composer Projects](#)
- [Accessing the Editors and Templates](#)

Also see [Upgrading Projects/Diagrams](#).

Callflow Post Installation

After installation of Composer, you need to perform some post-installation configuration tasks. **Note:** If you plan to use IIS as your web server for testing and deployment, you will also need to configure IIS preferences in Composer so that your applications can be auto-deployed to IIS from within the workbench. Composer can work only with IIS installed on the local machine. You can work with both Tomcat and IIS from the same installation of Composer. Also see: [Context Services Preferences](#).

Tomcat

Important

Starting with Composer 8.1.561.35, only Tomcat 10.1.x are supported. Provide the Tomcat installed location and Composer installed location in Preferences. Use the button, **Update tomcat configuration** to switch between Tomcat versions and ports.

1. Select **Window > Preferences**, then expand **Composer** and select **Tomcat**. Starting with 8.1.420.14, Composer supports Tomcat 7. Composer installation adds the role for manager-gui to Tomcat configuration for callflows and workflows. The default username and password for the bundled Tomcat is admin. The username and password for manager-gui is tomcat.
2. Provide the same port number that you specified during installation. The default user name and password for the bundled Tomcat is admin.
3. To start Tomcat, click the  button on the main toolbar.

If you already have Java Composer Projects in the workspace and did not perform the Tomcat configuration earlier, perform the following steps to deploy the project on Tomcat:

4. From the Project Explorer, right-click on the Java Composer Project and select **Properties**.
5. Select **Tomcat Deployment** and click the **Deploy** button.

Note: This also needs to be done if a Java Composer Project is imported.

Internet_Information_Services

1. Select **Window > Preferences**, then expand **Composer** and select **IIS/.NET**.
2. Provide the IIS website port number where you want to deploy your .NET Composer Project. The IIS Default Website Site port number is 80.

3. If you plan to use .NET Composer Project builder to compile the server-side files (.aspx) in your .NET Composer Project, you will need to configure the location of the aspnet_compiler.exe file in the **Microsoft .NET Installed Path** field.

Note: The typical location of the ASP.NET compiler is: C:\WINDOWS\Microsoft.NET\Framework\v2.0.50727\aspnet_compiler.exe.

4. Specify the **Web Services Enhancement (WSE)** path. This must be specified before Composer .NET Projects can work.

If you already have .NET Composer Projects in the workspace and did not perform the IIS configuration earlier, perform the following steps to deploy the project on IIS:

5. From the Project Explorer, right-click on the .NET Composer Project and select **Properties**.
6. Select IIS Deployment and click the **Deploy** button.

Note: This also needs to be done if a .NET Composer Project is imported or renamed as well.

GVP_Debugger

1. Select **Window > Preferences**, then expand **Composer** and select **Debugging**.
2. Specify the following settings:
 - **Network Interface.** Composer debugging uses this setting to make the socket connection for the Debugger control channel. Select the interface that is applicable to your scenario. The debugging server (GVP or ORS) must be able to access the Tomcat server, bundled as part of Composer, for fetching the Voice or Routing application pages. If you have multiple NIC cards of multiple networks (such as Wireless and LAN) select the interface on which GVP or ORS will communicate to your desktop. In case you are connected over VPN, select the VPN interface (such as PPP if connected via a Windows VPN connection).
 - **Client Port Range.** Enter a port range to be used for connection to ORS for SCXML debugging sessions.
3. Select GVP Debugger and specify:
 - **SIP Phone User Name.** This is the user name or phone number of your SIP Phone.
 - **SIP Phone Hostname/IP .** This is the IP address on which your SIP phone is running. It is possible to send the call to a SIP Phone located on some other machine, but it is generally advisable to have the SIP Phone locally for ease of access. If you have multiple NIC cards or interfaces, make sure you specify the same IP address as corresponds to the Network Interface selected above.
 - **SIP Phone Port.** This is the port on which your SIP phone is running.
 - **Platform IP.** This is the IP address of your GVP Server. Note: Composer 8.1 is compatible with GVP 8.1. Operation with GVP 8.0 is not supported.
 - **Platform Port.** Typically, this will be the default port 5060 or the port that you configured for the Resource Manager (RM) or Media Control Platform (MCP) on your GVP Server. You can make direct calls to MCP from the debugger. However, if using pre-provisioned DNIS, then

you will need to make test calls to the RM.

- **Use Secure Connection.** See [Debugging TLS Support](#).

Composer may display a prompt asking if you wish to propagate these settings to an existing [launch configurations](#).

MIME_Types

MIME (Multipurpose Internet Mail Extensions) refers to a common method for transmitting non-text files via Internet e-mail. By default the SCXML MIME type is already configured in the Tomcat server bundled with Composer. If you are using the Internet Information Services (IIS) Application Server to deploy ASP.NET projects, add the following MIME type extensions through the IIS Manager of your webserver:

.json	text/json
.vxml	text/plain
.scxml	text/plain
.xml	text/xml

Prompt_Resource_Validation

This preference enables diagram validation warnings where prompt audio resources no longer exist in the given file path. If the audio file is no longer present, the diagram block will show a warning icon.

1. Select **Window > Preferences**.
2. Select **Composer > Composer Diagram**.
3. Select the option **Enable Validation for Prompt Resources**. By default the preference is not enabled.

Media_Control_Platform

GVP 8.1 provides a debugger interface to allow Composer to make direct calls. By default it is turned off and you will have to enable it to allow GVP to accept calls from the debugger interface.

1. Outside of Composer, locate your Media Control Platform (MCP) Application. For example, you can open your MCP Application object in Configuration Manager or in Genesys Administrator for the Configuration environment that is serving the MCP platform.
2. Under the `vxmli` section of the MCP, look for a setting called `debug.enabled`. By default, it is set to `false`. Change the value to `true` and restart your MCP.

Firewall

If you have a local firewall on your machine, open up the following ports:

- Tomcat port (generally, this is set to port 8080). If you installed Tomcat on a different port, open its corresponding port in the firewall.
- IIS port (generally, this is set to port 80). If you installed IIS on a different port, open its corresponding port in the firewall.
- The UDP port on which your SIP phone is running (by default, this will be either 5060 or 5070). Check your SIP phone settings for the exact port number.
- RTP ports on which your SIP phone will get the audio stream. Check your SIP phone Help file for details on this. Some SIP phones will autoconfigure this during installation.

If you continue to run into problems with the firewall and calls are not coming through successfully, consult your network administrator.

Working with Java Composer Projects

A Java Composer Project contains voice application files, callflows, and related server side .jsp / Java files for building an IVR application. A Java Composer Project can also contain routing workflows. It has an associated Java Composer Project builder that will compile source files in the project. Composer ships with a bundled Tomcat and it is used as the web/application server for Java Composer Projects during the development and testing phase. For information on supported operating systems for Java Composer Projects, see the *Composer 8.1 Deployment Guide*.

Getting Started

To start using Java Composer Projects:

1. [Create a new Java Composer Project](#).
2. Use the Project **Properties** tab to deploy the Java Composer Project to **Tomcat** within Composer. (Right-click the project > **Properties** > **Tomcat Deployment**.)
3. Create callflows and use **Run or Debug mode** to launch the call with Next Generation Interpreter.

Note: Run as / Debug as will automatically pick the port number from the preferences and form the corresponding Application URL. For example: <http://machineIP:portno/JavaVoiceProjectName/src-gen/CallflowName.vxml>

Working with .NET Composer Projects

A .NET Composer Project contains voice application files and related server side .aspx / C# / files for building an IVR program. It has an associated .NET Composer Project builder based on Microsoft .NET Framework that can incrementally compile .aspx source files as they are changed.

Prerequisites

This step is not a mandatory prerequisite. Starting with 8.1.420.14, Composer allows creating .NET Composer Projects without the WSE dll files. Microsoft Web Services Enhancements (WSE) is also required for creating .NET projects in Composer. However, the WSE installer may not install on Windows 2008. These steps give a workaround:

1. Download the Microsoft WSE 3 "msi" installer bundle.
2. Use 7Zip to extract the contents to a folder.
3. In Composer, select **Window > Preferences > Composer > IIS/.NET**.
4. Set the Microsoft WSE 3.0 Installed Path field the \$Folder\Microsoft.Web.Services3.dll file.
5. Create your Composer .NET Projects.

Getting Started

To prepare for using .NET Composer Projects:

1. Install Microsoft IIS.
2. Install Microsoft .NET and .NET Framework.

Note: Microsoft .NET is required for Composer **Server Side** blocks.

1. Enable ASP.NET in your IIS.
2. Configure the following MIME settings in your IIS:
 - .ccxml - application/ccxml+xml
 - .vxml - text/xml
 - .grxml - application/srgs+xml
 - .vox - audio/basic
 - .scxml - application/xml

3. Configure the IIS Website Port number in Composer **IIS Preferences (Window > Preferences > .NET)**

By default, IIS comes with the DefaultWebSite which runs on port 80. If you want to deploy the .NET Composer Project in your custom website, configure the corresponding port number in the IIS Website Port field.

1. [Create a .NET Composer Project.](#)
2. Use the Project **Properties** tab to deploy the .NET Composer Project to IIS within Composer. (Right-click **Properties > IIS Deployment.**)
3. Create the diagram callflows and perform Run as / Debug as to launch the call with NGI.

Note: [Run as / Debug as](#) will automatically pick the port number from the preferences and form the corresponding application URL. For example: <http://machineIP:portno/NETProjectName/src-gen/CallflowName.vxml> Also see: [Request.Form Error Message for .NET Projects](#)

Preferences for Voice Applications

Composer Preferences are applicable at a workspace level. They apply to all projects within the workspace. To open the Preferences dialog box for Composer, select **Window > Preferences** and expand **Composer**.

Note: You can also set options in the Project Properties dialog box by right-clicking a Project and selecting **Properties**.

- [CCXMLFile Preferences](#)
- [Diagram Preferences](#)
- [GAX Server Preferences](#)
- [GRXML File Preferences](#)
- [VXML File Preferences](#)
- [GVP Debugger Preferences](#)
- [.NET Preferences](#)
- [Time Zone Preferences](#)
- [Tomcat Preferences](#)
- [XML Preferences](#)
- [Context Services Preferences](#)

There are also [Refresh automatically](#) and [Time zone](#) preferences.

Tip

You can also set options in the Project Properties dialog box. Right-click a Project and select **Properties**

CCXML File Preferences

Select **Window > Preferences > Composer > CCXML Files**. The following preferences for CCXML files can be set in the Preferences dialog box:

Creating Files

1. Under **Creating Files**, select the Suffix to use for CCXML files from the drop-down list: * ccxml
2. Select the **Encoding** type from the drop-down list. The encoding attribute in a CCXML document specifies the encoding scheme. The encoding scheme is the standard character set of a language. The CCXML processor uses this encoding information to know how to work with the data contained in the CCXML document. UTF-8 is the standard character set used to create pages written in English. Select from the following:
 - ISO 10646/Unicode(UTF-8)
 - ISO 10646/Unicode(UTF-16) Big Endian
 - ISO 10646/Unicode(UTF-16BE) Big Endian
 - ISO 10646/Unicode(UTF-16LE) Little Endian
 - US ASCII
 - ISO Latin-1
 - Central/East European (Slavic)
 - Southern European
 - Arabic, Logical
 - Arabic
 - Chinese, National Standard
 - Traditional Chinese, Big5
 - Cyrillic, ISO-8859-4
 - Cyrillic, ISO-8859-5
 - Greek
 - Hebrew, Visual
 - Hebrew
 - Japanese, EUC-JP
 - Japanese, ISO 2022
 - Japanese, Shift-JIS
 - Japanese, Windows-31J

- Korean, EUC-KR
- Korean, ISO 2022
- Thai, TISI
- Turkish

Validating Files

- Select or clear the **Warn when no grammar is specified** check box (not selected by default).

Source and Syntax Coloring

Source and Syntax Coloring preferences for CCXML files are set under the XML preferences provided by Eclipse.

- Use **Window > Preferences**, expand the **Web and XML** entry, then expand the **XML Files** subentry.

Templates

In addition to previewing templates, you can create, edit, and remove selected templates. There are also buttons to:

- Restore a removed template.
- Revert back to a default template
- Import a template.
- Export a template.

Diagram Preferences

Select **Window > Preferences > Composer > Composer Diagram**. The following preferences for diagrams can be set in the Preferences dialog box:

Global Settings

1. Select or clear the check box for each of the following diagram global settings:

- **Show Connection Ports.** If enabled, connection ports (both exception ports and out ports) are always displayed on blocks. This makes it convenient to draw links between blocks and to get immediate feedback on how many ports each block provides. However, in this case, the ability to reposition connections on a block is not available. If switched off, connection ports are not displayed by default, but repositioning or finer control over connection link placement becomes available. Note: This preference applies to all projects and is not available for individual projects.)
- **Show popup bars.** If enabled, this setting displays basic blocks from the blocks palette in a pop-up bar if you hover your mouse on the diagram for one or two seconds without clicking. Note: blocks are shown in icon view only.)
- **Enable animated layout.** If enabled, causes diagrams to gradually animate to their location when the Diagram \> Arrange \> Arrange All menu option is clicked.
- **Enable animated zoom.** If enabled, while using the zoom tools, shows a gradual transition between the initial and final state of the diagram on the canvas. If off, the zoom is instantaneous. Similar behavior for animated layout when the Diagram \>\> Arrange \>\> Arrange All menu option is clicked.
- **Enable anti-aliasing.** If enabled, improves the appearance of curved shapes in the diagram. You can see its effect on the circles in the Entry and Exit blocks.
- **Show CodeGen success message.** If unchecked, then the confirmation dialog at the completion of code generation will not be shown.)
- **Prompt to Save Before Generating Code.** If checked, when you generate code for an unsaved diagram, a prompt appears indicating the diagram has been modified and asking if you want to save the changes before generating code. The dialog box also contains a checkbox: Automatically save when generating code and do not show this message again.
- **Show Validation success message.** If unchecked, then the confirmation dialog at the time of Validation will not be shown.)
- **Enable Validation for Prompt Resources.** This preference is used for voice applications. If unchecked, then a validation check for missing prompts is not performed at the time of Validation.
- **Interaction Process Diagram.** If unchecked, Composer will save Interaction Process Diagrams before publishing.
- **Prompt to delete Published objects when Interaction Process Diagram is deleted.** If unchecked, Composer will attempt to delete any Published objects when an Interaction Process Diagram is deleted. If Composer is not connected to Configuration Server, object

deletion will not work.

- **Parameters auto synchronization** (available starting with 8.1.410.14). This option reduces developer coding time by enabling Composer to automatically declare variables in a Main diagram to match input/output variable names in Subdialog block/Subroutine diagrams and to automatically perform the mapping. This feature is available for both user and system variables. For example, if a Subroutine diagram returns a variable called “xyz” and if Composer automatically declares “xyz” in the Main diagram to hold the output, then you do not have to manually do the mapping. If enabled, you are prompted for auto-synchronization whenever there is a need to change parameters names or add new variables in the dialogs.

Scenarios:

1. Subdialog or Subroutine Diagram: Entry Block—The auto-synchronization process will synchronize any newly added/updated variables and existing variables in the Subdiagram. If you add a new Input type variable, a prompt appears asking whether to add a corresponding Input parameter. You are also prompted to select or add the Input source variable in all the called Subroutine diagrams. New parameter naming in the calling Subdialog block is the same as the Input variable added in the Entry Block. If the Subroutine diagram is called from many diagrams, Composer provides a variable selection option for the called diagrams.
2. Main callflow Diagram: Entry Block—If you add a new Input type variable, a prompt appears asking whether to add the corresponding input parameter. You are also prompted to select or add an Input source variable in all the called Play Application blocks. New Parameter naming in the calling Play Application block is the same as the Input variable added in the Entry Block. If the Main diagram was called from multiple Play Application blocks, a variable selection option for all the called blocks is provided.
3. Subdialog or Subroutine diagram: Exit Block—If you change or delete a return parameter, a prompt appears on whether to delete the Output parameter and/or the missing ones in case of a change in all the called Subroutine or Subcallflow diagrams.
4. The auto-synchronization parameter option also applies when there is a change in a configured Subroutine diagram. The auto-synchronization dialog confirmation appears as soon as a Subroutine diagram is added/updated. If the confirmation dialog is selected, it automatically synchronizes the Subroutine parameters to the Main diagram. This auto-synchronization prompt always appear even though the same diagram is updated again. When Output parameters are added in the Exit block, parameter synchronization also occurs.
5. **Application URL for Publish and Debugging.** Select **Use IP Address** or **Use Host Name**.

Notes:

Composer creates unique names for auto-sync variables, such as <SubBlockName>_<VariableName>. SubBlockName is the name of the Subroutine/ Subdialog / Play Application blocks where the Subroutine diagram is being invoked. VariableName is the input variable name created in a Subroutine diagram.

2. Click **Apply**.

Colors and Fonts

1. Select **Appearance** under Composer Diagram.

2. Click **Change** and make selections to change the default font if you wish.
3. Click the appropriate color icon beside any of the following and make selections to change color:
 - **Font color**
 - **Fill color**
 - **Line color**
 - **Note fill color**
 - **Note line color**
4. Click **Apply**.

Connections

1. Select **Connections** under Composer Diagram.
2. Select a line style from the drop-down list:
 - **Oblique**
 - **Rectilinear**
3. Click **Apply**.

Pathmaps

1. Select **Pathmaps** under Composer Diagram.
2. Click **New** to add a path variable to use in modeling artifacts, or If the list is populated, select the check box of a path variable in the list.
3. Click **Apply**.

Printing

1. Select **Printing** under Composer Diagram.
2. Select **Portrait** or **Landscape** orientation.
3. Select units of Inches or Millimetres.
4. Select a paper size (default is Letter).
5. Select a width and height (for inches, defaults are 8.5 and 11; formillimeters, defaults are 215.9 and 279.4).
6. Select top, left, bottom, and right margin settings (for inches, defaults are 0.5; for millimeters, defaults

are 12.7).

7. Click **Apply**

Rulers and Grid

You can make use of rulers and grids when creating diagrams. Rulers and grids can provide a backdrop to assist you in aligning and organizing the elements of your callflow diagrams.

1. Select Rulers and Grid under Studio Diagram.
2. Select or clear the **Show rulers for new diagram** check box (not selected by default).
3. Select ruler units from the drop-down list:
 - **Inches**
 - **Centimeters**
 - **Pixels**
4. Select or clear the Show grid for new diagrams check box (not selected by default).
5. Select or clear the Snap to grid for new diagrams check box (selected by default).
6. Type a value for grid spacing (for inches, the default is 0.125; for centimeters, the default is 0.318; for pixels, the default is 12.019).
7. Click **Apply**.

GAX Server Preferences

Select **Window > Preferences > Composer > GAX Server**.

If using the **OPM Block** for a voice or routing application, you must set GAX Server Preferences.

Tip

GAX refers to a **Genesys Administrator** Extension (GAX) plug-in application used by **Genesys EZPulse**, which is accessible from a web browser. EZPulse enables at-a-glance views of contact center real-time statistics in the GAX user interface. Composer diagrams connect to GAX using the preference login credentials for fetching the Audio Resource Management (ARM) parameters or IDs list configured for the tenant as described in the Configuration options appendix of the *Genesys Administrator Extension Deployment Guide*.

The following preferences can be set in the GAX Server Preferences dialog box:

- **Server Host Name/IP.** Enter the hostname or address of the Application server hosting the GAX Server.
- **Port Number.** Enter the port number for the GAX Server used in your environment.
- **Username.** Enter the username defined in the Configuration Database for logging into the GAX server.
- **Password.** Enter the password defined in the Configuration Database for logging into the GAX server.

GRXML File Preferences

Select **Window > Preferences > Composer > GRXML Files**. The following preferences for GRXML files can be set in the Preferences dialog box:

Creating Files

1. Under **Creating Files**, select the Suffix to use for GRXML files from the drop-down list:* grxml
2. Select the **Encoding** type from the drop-down list. The encoding attribute in a GRXML document specifies the encoding scheme. The encoding scheme is the standard character set of a language. The GRXML processor uses this encoding information to know how to work with the data contained in the GRXML document. UTF-8 is the standard character set used to create pages written in English. Select from the following:
 - ISO 10646/Unicode(UTF-8)
 - ISO 10646/Unicode(UTF-16) Big Endian
 - ISO 10646/Unicode(UTF-16BE) Big Endian
 - ISO 10646/Unicode(UTF-16LE) Little Endian
 - US ASCII
 - ISO Latin-1
 - Central/East European (Slavic)
 - Southern European
 - Arabic, Logical
 - Arabic
 - Chinese, National Standard
 - Traditional Chinese, Big5
 - Cyrillic, ISO-8859-4
 - Cyrillic, ISO-8859-5
 - Greek
 - Hebrew, Visual
 - Hebrew
 - Japanese, EUC-JP
 - Japanese, ISO 2022
 - Japanese, Shift-JIS
 - Japanese, Windows-31J

- Korean, EUC-KR
- Korean, ISO 2022
- Thai, TISI
- Turkish

Validating Files

- Select or clear the **Warn when no grammar is specified** check box (not selected by default).

Source and Syntax Coloring

Source, Syntax Coloring, and Template preferences for GRXML files are set under the XML preferences provided by Eclipse.

- Use **Window > Preferences**, expand the **Web and XML** entry, then expand the **XML Files** subentry.

Templates

In addition to previewing templates, you can create, edit, and remove selected templates. There are also buttons to:

- Restore a removed template.
- Revert back to a default template
- Import a template.
- Export a template.

VXML File Preferences

Tip

Composer natively supports VXML 2.1.

Select **Window > Preferences > Composer > VXML Files**. The following preferences for VXML files can be set in the Preferences dialog box:

Creating Files

1. Under **Creating Files**, select the Suffix to use for VXML files from the drop-down list: *.vxml
2. Select the **Encoding** type from the drop-down list. The encoding attribute in a VXML document specifies the encoding scheme. The encoding scheme is the standard character set of a language. The VXML processor uses this encoding information to know how to work with the data contained in the VXML document. UTF-8 is the standard character set used to create pages written in English. Select from the following:
 - ISO 10646/Unicode(UTF-8)
 - ISO 10646/Unicode(UTF-16) Big Endian
 - ISO 10646/Unicode(UTF-16BE) Big Endian
 - ISO 10646/Unicode(UTF-16LE) Little Endian
 - US ASCII
 - ISO Latin-1
 - Central/East European (Slavic)
 - Southern European
 - Arabic, Logical
 - Arabic
 - Chinese, National Standard
 - Traditional Chinese, Big5
 - Cyrillic, ISO-8859-4
 - Cyrillic, ISO-8859-5
 - Greek
 - Hebrew, Visual
 - Hebrew

- Japanese, EUC-JP
- Japanese, ISO 2022
- Japanese, Shift-JIS
- Japanese, Windows-31J
- Korean, EUC-KR
- Korean, ISO 2022
- Thai, TISI
- Turkish

Validating Files

- Select or clear the **Warn when no grammar is specified** check box (not selected by default).

Source, Syntax Coloring, and Templates

Source, Syntax Coloring, and Template preferences for VXML files are set under the XML preferences provided by Eclipse.

- Use **Window > Preferences**, expand the **Web and XML** entry, then expand the **XML Files** subentry.

This preference allows you to add **custom VXML schemas** into Composer to be used in namespaces for new VXML files created through the VXML editor.

GVP Debugger Preferences

Select **Window > Preferences > Composer > Debugging > GVP Debugger**. GVP Debugger preferences are usually set during **callflow post-installation configuration**, when you first run Composer. Detailed post-installation configuration instructions are also provided in the Configure Tomcat and Debugger Settings Cheat Sheet (**Help > Cheat Sheets > Composer > Voice Applications**).

IIS.NET Preferences

Select **Window > Preferences > Composer > IIS/.NET**.

IIS/.NET preferences are usually set during post-installation configuration, when you first run Composer. Detailed post-installation configuration instructions are provided in the Setting IIS Preferences Cheat Sheet (**Help > Cheat Sheets > Composer > Building Voice Applications**), and also in [Post-Installation Configuration](#).

Setting Context Services Preferences

Go to **Window > Preferences > Composer > Context Services** to open the Context Services dialog box. If using a Composer version prior to 8.1.440.18, the dialog box will not contain a **Service management** section.

Context Services

Context Services are provided by the Universal Contact Server (UCS) and the Genesys Mobile Services (GMS).

Customer Profile management. These settings apply to Profile related blocks.

Connect to the Universal Contact Server when designing diagrams

Server Hostname: 127.0.0.1
Server Port: 80
Base URL:

Security Settings
Use secure connection:
 Never TLS
 Use authentication
User:
Password:
Test Connection

Service management. These settings apply to Service related blocks.

Use Genesys Mobile Services
 Connect to the Universal Contact Server when designing diagrams

Server Hostname: 127.0.0.1
Server Port: 80
Base URL: genesys/1/cs
Tenant: 1

Security Settings
Use secure connection:
 Never TLS
 Use authentication
User:
Password:
Test Connection

Context Services objects Validation
 No validation
 Validate if connected
 Validate

Locale settings
Time Zone: (GMT-08:00) America/Los_Angeles

Restore Defaults Apply

OK Cancel

Guidelines for Context Services Preferences

[+] Guidelines for Context Services Preferences

The table below supplies some guidelines for defining Context Services Preferences.

Installation Type	Customer Profile Management	Service Management
Context Services 8.1 or earlier - Profile and Service APIs served by UCS	Set UCS parameters according to UCS options.	Do not check the Use Genesys Mobile Service checkbox. Set the UCS parameters according to UCS options.
Context Services 8.5 or later - No Load Balancer	Set UCS parameters according to UCS options.	Check the Use Genesys Mobile Service checkbox. Set GMS parameters according to GMS options.
Context Services 8.5 or later - Load Balancer (LB)	Set UCS parameters to match the LB options.	Check the Use Genesys Mobile Service checkbox. Set GMS parameters to match the LB options.

Customer Profile Management Section

1. Use the [Guidelines for Context Services Preferences](#) section above for selecting/unselecting the **Connect to Universal Contact Server when designing diagrams** box.
2. Under **Server Host Name**, enter the server host IP address in your Configuration Database, which identifies the Universal Contact Server. See Tip below.
3. Enter the **Server Port number** for Universal Contact Server. For the port number, open the Universal Contact Server Application object in your Configuration Database, go to **Options** tab, select the **cview** section, and the port option.
4. Enter the **Base URL** for the Context Services server. This should only be configured if you use UCS 8.1. Do not set if you use UCS 8.5.
5. Under **Security Settings, Use secure connection**, select **Never** or **TLS** if Transport Layer Security is implemented as described in the [Genesys 8.1 Security Deployment Guide](#).
6. Select **Use Authentication** to require a user name and password when connecting to Universal Contact Server. If selected, enter the **User** and **Password** fields.
7. Click the **Test Connection** button (enabled if the **Connect to Universal Contact Server when designing diagrams** box is checked). Clicking should cause connection successful to appear. If not, check that Universal Contact Server is running and that the entered host/port values are correct. Other sources of error could be that the base URL parameter value is incorrect or the UCS version is not 8.1 or higher.
8. Under **Context Services object Validation**, select one of the following: **No validation**, **Validate if connected**, or **Validate**. This setting is used and shared by the [Profile/Service blocks](#).

Tip

Host/port/URL/tenant are used at design time by Composer (when the **Connect to Universal Contact Server when designing diagrams** box is selected). They are also used by Composer when publishing an **interaction process diagram**. Composer stores these parameters in the EnhancedRoutingScript objects. SCXML applications can then read those settings at runtime to connect to UCS/GMS accordingly.

Service Management Section

1. Select either **Use Genesys Mobile Services** or **Connect to the Universal Contact Server when designing diagrams**. See [Guidelines for Context Services Preferences](#) section above for more information. Steps 2, 3, and 4 below relate to UCS or GMS, depending on the **Use Genesys Mobile Services** box.
2. Under **Server Host Name**, enter the host IP address. See above note (Tip).
3. Enter the server port number.
4. Enter the **Base URL** for the host. When using GMS, the base URL is normally /genesys/1/cs.
5. Enter the **Tenant**. GMS Context Services (optionally) supports multi-tenancy. The tenant to use is passed as a header (ContactCenterId=x) of the request. This field is disabled when **Connect to the Universal Contact Server when designing diagrams** is selected.
6. Under **Security Settings, Use secure connection**, select **Never** or **TLS if Transport Layer Security** is implemented as described in the [Genesys 8.1 Security Deployment Guide](#).
7. Select **Use authentication** to require a user name and password. If selected, enter the User and Password fields.
8. Click the **Test Connection** button. Clicking should cause connection successful to appear. When using GMS, no connection is made from Composer to GMS. Connections to GMS are initiated only at runtime by ORS/MCP.
9. Under **Context Services object Validation**, select one of the following: **No validation**, **Validate if connected**, or **Validate**. This setting and the setting below is used and shared by the [Profile/Service blocks](#).
10. Under **Local Settings**, select the time zone.

Tip

Composer can successfully communicate with UCS at design stage whatever the UCS mode is (production or maintenance). However, UCS needs to be in production mode at runtime stage (when running Context Services SCXML or VXML applications, even when using GVP Debugger).

Time Zone Preferences

Composer displays all date/time elements in the user-preferred time zone with the time zone identifier. You can change the preferred time zone in **Window > Preferences > Composer > Context Services**.

Tomcat Preferences

Select **Window > Preferences > Composer > Tomcat** Tomcat preferences are usually set during post-installation configuration, when you first run Composer. Detailed post-installation configuration instructions are provided in the Configure Tomcat and Debugger Settings Cheat Sheet (**Help > Cheat Sheets > Composer > Building Voice Applications**), and also in [Callflow Post-Installation Configuration](#) or [Workflow Post Installation Configuration](#).

XML Preferences

You can also set XML File Preferences for both routing and voice applications: **Window > Preferences > XML > XML Files**. When specifying Encoding formats in the XML Preference page: encoding formats are applicable only for new File creation using the Template option: (**File > New > XML > XML File > Create XML File from an XML Template > Select XML Template**). This applies only to new XML, VXML, CCXML and SCXML files. Existing files within the Project will not get impacted.

Creating Voice Apps for GVP

This section provides key information about using Composer to build VoiceXML-based callflow applications after [callflow post installation configuration](#). You should be well-versed in VoiceXML, XML, and HTML before attempting to use Composer. You should also have reviewed [Getting Started with Voice Applications](#). To help you get started:

- From within Composer, select **Help > Cheat Sheets > Composer** to see how some basic voice applications can be created.
- [Your First Application](#)
- [Sample Applications & Templates](#).

To start immediately, see:

- [Creating VXML Applications](#) or
- [Creating CCXML Applications](#)

What is GVP and How Do Voice Apps Work

The Genesys Voice Platform (GVP) is a VoiceXML-based media server for network service providers and enterprise customers.

What is GVP?

At the most basic level, Genesys Voice Platform (GVP) is Interactive Voice Response software (soft IVR). At a more complex level, GVP is a software suite that integrates a combination of call processing, reporting, management, and application servers with Voice over IP (VoIP) networks, to deliver web-driven dialog and call control services to callers.

Using features such as Automatic Speech Recognition (ASR) and Text-to-Speech (TTS), GVP provides a cost-effective way to implement automated voice interactions from customers calling your contact center. At the technology level, GVP is a collection of software components that complement and work with other Genesys products in order to provide a complete voice self-service solution.

Notes:

Whereas GVP is commonly used in enterprise self-service environments, many other applications of GVP—including those outside of the contact center—are possible.

A machine on which GVP components are installed is also referred to as a GVP Server in other places in this Help system.

Use Case

An example flow for a GVP voice self-service application is presented below:

- A customer calling into an IVR would get Prompts / Announcements with a Welcome message. These prompts could be specific to a region based on incoming DNIS number or customized based on user options, such as a prompt to select a language.
- The applications could have business control logic allowing Business users to define open and close hours, set emergency announcements and flags, define special days, and so on. These options could be defined within Genesys Administrator or Genesys Rules System.
- The application can have the capability to collect user input with multiple options and repeatability to handle no input / no match capabilities.
- Once the application gets the user input, such as account number, this information can be verified against back office applications or can have the capability to pull data from a Conversation Manager Solution
- Customer information retrieved can be attached to the interaction as user data and could be used for Customer Segmentation and thereby determine how a particular customer would be managed within the self-service

- The application can provide self-service with Voice Recognition options and DTMF options in menus.
- The application can be configured to allow users to opt out of the self-service by default or within the predefined flow of the application.
- When users opt out of the IVR, they could be routed to an external source or to an Agent based on the environment as defined above. For example, customers could make a choice to get routed to “Last Called Agent” or be routed to any Agent by pressing repetitive “0”.
- Customers can have defined activities across the flow of the self-service and also be able to set milestones to define success/failure criteria within each segment of the flow.

How Do Voice Applications Work?

Just as one uses HTML to create visual applications, VoiceXML is a mark-up language one uses to create voice applications. With a traditional web page, a web browser will make a request to a web server, which in turn will send an HTML document to the browser to be displayed visually to the user. With a voice application, it's the VoiceXML interpreter that sends the request to the web server, which will return a VoiceXML document to be presented as a voice application via a telephone. What makes VoiceXML so powerful is that all of the most popular tools for making web pages are available for making voice applications. Developers can use technologies they are already familiar with such as JavaScript, JSP and ASP.NET/C# to generate exciting new voice applications.

The "Big Picture"

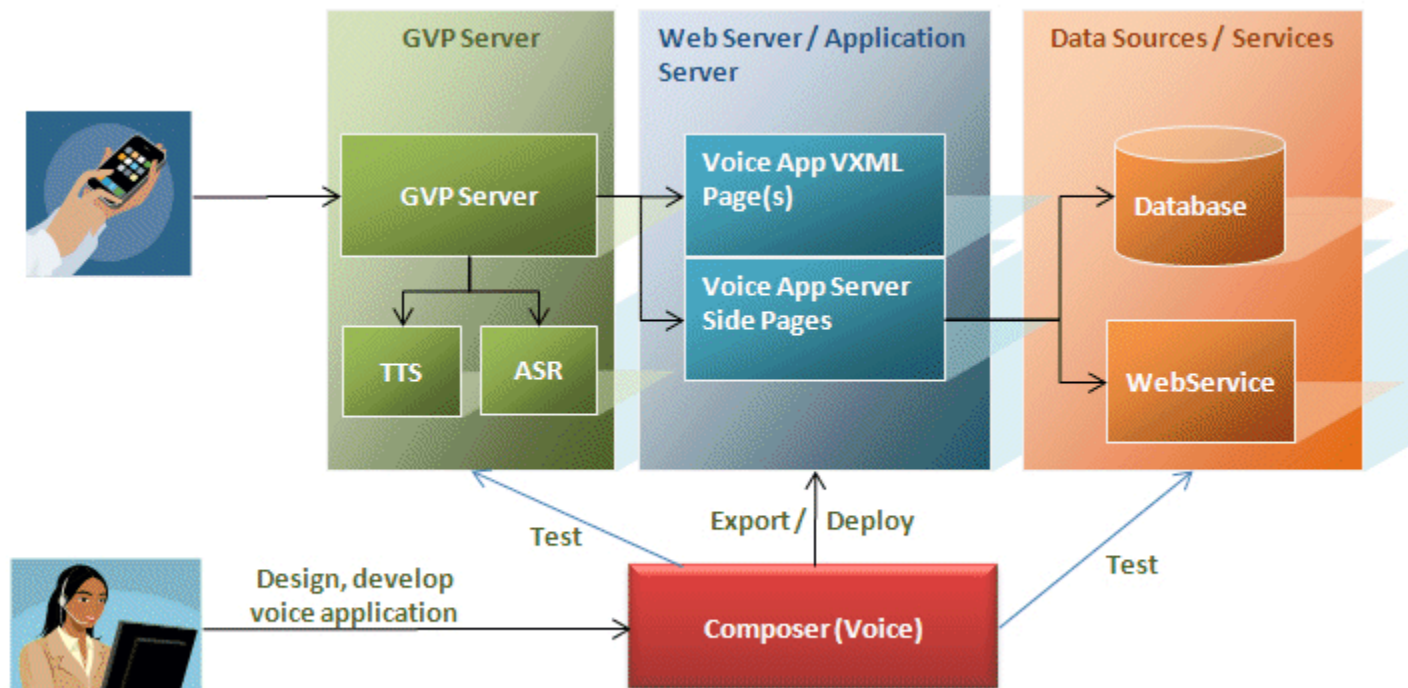

Composer is a fully featured VXML application development tool. Users can develop, debug and test their applications in its Integrated Development Environment (IDE) that provides developer-friendly features to test and debug VXML applications and server side web pages. Once the application is ready, it can be exported or manually deployed using an exported package onto an application server/web server like Tomcat or Microsoft IIS. Once deployed, GVP can access the voice application's VXML pages and any server side pages (JSP/ASP.NET) using HTTP.

When a call comes in to GVP, GVP determines the location of the VXML application through its provisioning data. It then fetches VXML page(s) and uses its VXML engine to execute them. The results are played back to the caller on his/her phone. Any server side pages that access databases or web services or other server side pages are executed on the application server/ web server through server side constructs implemented by Composer.

During development, Composer can use its bundled Tomcat or a local installation of Microsoft IIS as the web server and make test calls to the application right through GVP from within the IDE. This feature provides a quick way to test applications by removing the need to of deploy applications to another server and then point GVP to that location.

Once the application is deployed in production, Composer is no longer in the picture. The application is usually deployed on its own dedicated web server and application server from where it is accessed by GVP. The web/application server provides access to all pages and scripts that make up the application and executes any server side pages of the application.

Creating CCXML Applications

CCXML (Call Control XML) is a specification developed by the Call Control subgroup of the Voice Browser Working Group of the [W3C](#). CCXML provides mechanisms for implementing advanced call control functionality in a standards-based way. It provides the advanced call control features not supported by VoiceXML. You develop CCXML a little differently than VXML or SCXML applications. Rather than creating flow diagrams, you invoke a CCXML text editor and enter the code while Composer performs syntax checking. To create a new CCXML file in Composer perspective:

1. From the menu, select **File > New > Other > CallControlXML** File.
2. In the wizard, select the Project folder, name the file, and click **Finish** or **Next** to use a template.
3. If you click **Next**, select a template and click **Finish**. Composer opens the the CCXML editor view.

Creating VXML Applications

When building any application in Composer, you first need to create a **Project**. A Project contains all the callflows, audio and grammar files, and server side logic for your application. By associating a routing strategy with a Project, you enable Composer to manage all the associated files and resources in the **Project Explorer**.

Cheat Sheet

Composer provides a cheat sheet to walk you through the steps for building a voice application.

- In the Welcome Screen (**Help > Welcome**), click the icon for Tutorials and select the Create a Voice Application tutorial. It will also describe the steps for how to make test calls and debug your application.
- If you are already inside the **Workbench and Perspectives**, access the same cheat sheet from the Menu bar at the top by selecting Help > Cheat Sheets, then Create Voice Application from the Building Voice Applications category.

Creating a New Project

You can follow the steps below to create a new Project:

1. For a Java Composer Project to be deployed on Tomcat, click the toolbar button to create a **Java Composer Project**. For a .NET Composer Project to be deployed on IIS, click the toolbar icon to create a **.NET Composer Project**.
2. In the Project dialog box, type a name for your Project.
3. If you want to save the Composer Project in your default workspace, select the **Use default location** check box. If not, clear the check box, click Browse, and navigate to the location where you wish to store the Composer Project.
4. Select the Project type:
 - **Integrated Voice and Route**. Select to create a Project that contains both callflows and workflows that interact with each other; for example a routing strategy that invokes a GVP voice application. For more information on both voice and routing applications, see [What is GVP and How Do Voice Apps Work?](#) and [What Is a Routing Strategy](#), respectively.
 - **Voice**: Select to create a Project associated with the GVP 8.x. This type of Project may include callflows, and related server-side files. For more information on this type of Project, see topic, [How Do Voice Applications Work](#).
 - **Route**: Select to create a Project associated with the Orchestration SCXML Engine/ Interpreter and Universal Routing Server. For more information on this type of Project, see topic, [What Is a Routing Strategy](#).

5. Click Next.
6. If you want to use templates, expand the appropriate Project type category and select a template for your application. Templates are [sample applications](#) for different purposes. If you want to start from scratch, choose the Blank Project template and click Next.
7. Select the default [locale](#) and click Next.
8. Optional. If using the in a VoiceXML application, select the **Enable ICM** checkbox to enable integration. When checked, ICM variables will be visible in the Entry block. See the [ICM Interaction Data block](#) for more information.
9. Click **Finish**. Composer now creates your new Project. Your new Project folder and its subfolders appear in the Project Explorer.
10. To view/change settings not included under Preferences, right-click the Project and select **Properties**.

If you have never created a Composer Project, we recommend starting with [Your First Application](#).

Creating a New Callflow

To add a new callflow diagram to an existing Composer Project:



1. Click the  button on the main toolbar to create a new callflow. Or use the keyboard shortcut: Ctrl+Alt+O.
2. In the wizard, select the tab for the type of the callflow. There are two main types of callflows in Composer represented by wizard tabs:
 - Main Callflow: Used for the main application where the call will land or be transferred to from another application.
 - Subcallflow: Used for modularizing your applications. It is useful for structuring large applications into manageable components.

Additionally you will benefit from the automated transaction reports associated with **Subcallflows**. Action Start and Action End VAR events are auto-generated for **Entry** and **Exit** blocks.

3. Select either Main Callflow or Subcallflow.
4. Select the type of diagram.
5. Click Next.
6. Select the Project.
7. Click Finish.
8. Create the callflow.

Validation

Composer can validate your diagram files and other source files for completeness and accuracy. For more information, see [Validation](#).

Code Generation

The process of generating code creates a properly-formatted VoiceXML file from a callflow diagram built with Composer or a SCXML file from a workflow diagram. Static pages (pure VXML or SCXML code) are generated in the src-gen folder of the Composer Project. You can generate code in a couple of ways:

- Select Diagram > Generate Code.
- Click the Generate Code icon  on the upper-right of the Composer main window when the callflow/workflow canvas is selected.

Note: If your project uses the [Query Builder](#) or [Stored Procedure Helper](#)-generated queries in [DB Data](#) blocks, the process of code generation will create one SQL file in the db folder for each such DB Data block. These SQL files will be used at runtime and should not be deleted.

Code Generation for Multiple Callflows

When using the Run as Callflow function, Composer automatically generates the VXML files from the diagram file that you want to run. When generating code, with the generate code function for a Java Composer Project that has multiple callflows, Composer attempts to generate the VXML for all the callflows before running (because the application might move between multiple callflows for subdialogs). However, if one of the callflows has an error, Composer provides the option to continue running the application anyway, because the erroneous callflow may be a callflow that's not used by the one being run (if there are two or more main callflows, for example). When this happens, the VXML files are basically out of sync with the diagram files and this may affect execution. Genesys recommends that you fix all errors before running the application.

Deploying/Testing Your Application

After you have saved your files and **generated code** for your application, test the application as follows:



1. Deploy the project for testing.
 - If deploying a Java Composer Project, Composer bundles Tomcat for running test applications, such as routing applications. If you **configured the Tomcat settings** prior to creating your Project, it will be auto-deployed on the Tomcat Server. You can double check this by clicking on the name of the project in the Project Explorer, then right-click and select Project Properties. Select the Tomcat deployment category and verify that the project is deployed. If not, click Deploy.
 - If deploying a .NET Composer Project, deploy your project on an IIS Server. Be sure you have configured the IIS settings. Click on the name of the project in the Project Explorer, then right-click and select Project Properties. Select the IIS deployment category and verify that the project is deployed. If not, click Deploy.
2. For Voice Projects, use Run mode to run the application by selecting Run > Run As > Run Callflow, or by right-clicking on the callflow file name in the Project Explorer and selecting Run As > Run Callflow. The code is generated in the src-gen folder and the debugger sends the call to your SIP Phone.
3. Accept the call and you will be connected to the application on GVP. The call traces will become visible in the Call Trace window, and you should hear the voice application run.

Hello World Sample

Here is a simple voice application to help you get started with Composer. This application says Hello World when the call is answered.

Simple Text-to-Speech Application

To build a simple text-to-speech (TTS) application that says Hello World to the caller:

1. **Create a new Composer Project** called Hello World.
2. **Add the following blocks** from the Basic Blocks Palette to the canvas area: **Entry**, **Prompt**, and **Exit**, then connect them with **Output Links**.
3. Select the Entry block, or right-click the Entry block and select **Show Properties View** from the shortcut menu, if you want to set any properties (optional).
4. Select the Prompt block, or right-click the Prompt block and select **Show Properties View** from the shortcut menu.
5. Select the Name property and type a name in the Value field.
6. Select the Prompts property and click the  button.
7. Click the **Add** button and type a name in the Name field (optional).
8. Select **Value** in the Type drop-down list (default).
9. Select **Text** in the Interpret-As drop-down list (default).
10. Type **HelloWorld** (one word) in the Value field.
11. Click **OK**.
12. Save the file by selecting **File > Save**. You will not be able to generate code if you do not save the file.
13. Generate the code by selecting **Diagram > Generate Code**, or by clicking the Generate Code icon  on the upper-right of the Composer main window when the callflow canvas is selected.
14. If you get any errors, double-click on the error to get the details and fix the problem. For the Hello World application, typical problems would be forgetting to add the Hello World prompt or forgetting to link the blocks together.
15. If code generation succeeds, click OK at the confirmation dialog box.
16. Make sure the project is deployed for **testing**. Composer bundles Tomcat for running test applications. If you **configured the Tomcat settings** prior to creating your Composer Project, it will be auto-deployed on the Tomcat Server. You can double check this by clicking on the name of the project in the Project Explorer, then right-click and select Project Properties. Select the Tomcat deployment category and verify that the project is deployed. If not, click Deploy.
17. Select the callflow in the Project callflows folder.
18. Run the application by selecting **Run > Run As > Run Callflow**, or by right-clicking on the callflow file

name in the Project Explorer and selecting **Run As > Run Callflow**.

The code is generated in the src-gen folder and the **GVP debugger** sends the call to your SIP Phone.

19. Accept the call and you will be connected to the application on GVP. The call traces will become visible in the Call Trace view, and you should hear Hello World played through the phone.

Adding Blocks

There are a few ways to add blocks from the Palette to the canvas. The most common methods are as follows:

- Click on the block icon on the palette, release the mouse and click on the target location on the canvas area.
- Double-click a block icon on the palette.
- Click on the block icon on the palette, and while holding down the mouse button, drag and drop the block to the canvas.

Any of these methods will add the new block and you can then type the name of the block on the canvas itself. Click [here](#) to read about block naming restrictions.

Connecting Blocks

Blocks are connected to each other using connection links. There are two types of connection links:

- **Output Links** used to connect one block's output port to another block's input port, and
- **Exception Links** used to indicate error or exception conditions by connecting from a block's exception port to another block's input port.

To add a new Output Link (or Exception Link):

1. Click the Output Link (or Exception Link) icon in the palette.
2. Move the mouse over to the source block. The cursor will change to an upward arrow.
3. Click once on the source block and keep the mouse button pressed. Then drag the mouse onto the target block and release the mouse button.

This will add the connection link between the two blocks. To use an Exception Link, the source block must have an exception port defined. This is done by selecting at least one supported exception within the block's Exceptions property.

Another method for adding an Output Link or Exception Link between two blocks is as follows:

1. Click once on the source block to select it.
2. Hold the Ctrl key and click once on the target block to select it as well.

3. Double-click the Output Link (or Exception Link) icon in the palette to create a connection between the two blocks.

Again, to use an Exception Link, the source block must have an exception port defined.

The preference Show Connection Ports (in [Composer DiagramPreferences](#)) affects how connection links can be drawn to connect blocks. If it is switched on, links may be drawn directly by dragging from an outport of a block and dropped onto a block or its inport. This method will work in addition to using the Output link and Exception link tools. If the setting is switched off, connection ports are not displayed and therefore the method of drawing links mentioned above is not available.

Callflow Blocks

A block is the fundamental element of a callflow. Each block defines specific properties and how to handle specific events. You use the **Link tools** to connect these blocks in the order that the application should follow. A single VXML application is generated per callflow. Each block in a callflow becomes a form in the generated VXML document.

VXML Properties

Each block has custom VoiceXML properties. These properties appear within a Properties view at the bottom of the Composer window when you right-click the block and then select Show Properties View from the shortcut menu. For each block, specific properties determine how events are handled. There are several categories of properties depending on the specific block. The blocks build a callflow or subcallflow. Generate code either from the Toolbar or from the Diagram menu. Static VXML pages (pure VXML code) are generated in the src-gen folder.

Main Versus Subcallflow

There are two types of callflows:

- **Main Callflow:** This is the starting callflow for any application.
- **Subcallflow:** This is a component callflow that can be called from the main callflow or another subcallflow.

Each main callflow or subcallflow application should have at least three blocks:

- The **Entry block** to start the application. This block also specifies the relative file locations of the **audio files** for the generated application code and default exception handling.
- At least one other block to perform specific functions such as passing a call to an agent, creating a log of an activity, requesting caller input, playing a prompt, and so on.
- The Exit block to end the application, or, for example, the **GoTo block** to direct the application to another application.

Subcallflows

Subcallflows are used for modularizing applications and for writing components that can be reused by multiple applications (such as a credit card validation subcallflow). The usage of subcallflows within a main callflow is very similar to a function call in a programming language. One or more input parameters can be passed to a subcallflow. Similarly, the subcallflow can return one or more output parameters. Therefore, a subcallflow can be designed to behave differently depending on the input parameter(s) passed.

Variables in Callflows

You can define voice application (session) variables using the [Entry block Variables property](#).

Note: For information on user data and GVPSessionID, see the [Project Properties dialog box](#), Composer Callflow Option.

Types of Variables

Composer supports the following types of variables for callflow diagrams:

- **Application Root**--Automatically filled from either `session.com.genesyslab.userdata` or `session.connection.protocol.sip.requesturi` based on the Nnn-CTIC or CTIC flow. Also see the [Entry Application Root Property](#).
- **System** --Pre-defined application variables (Entry block Variables property) hold Project and application-related values. While you cannot delete System variables, you can have your application modify the values.

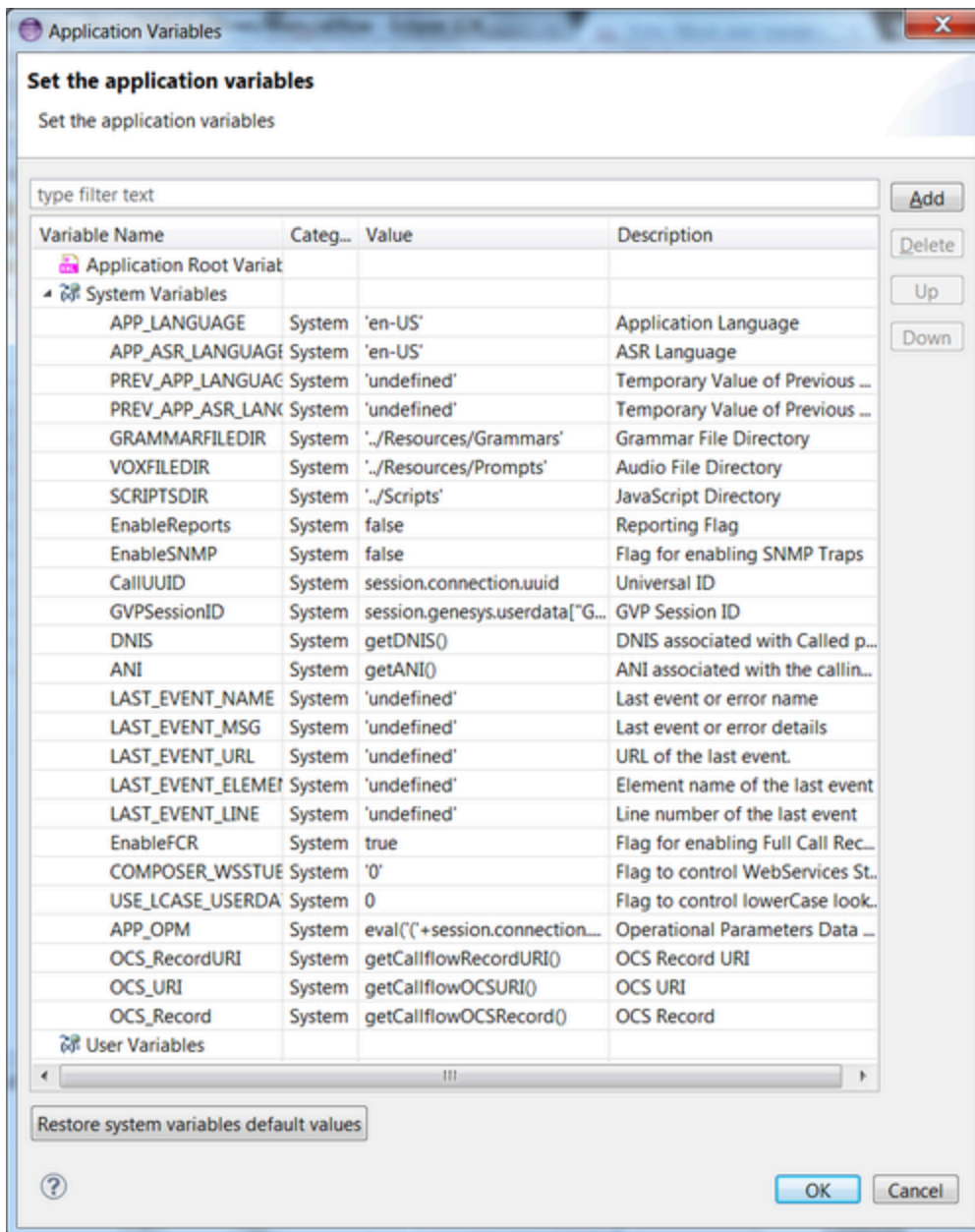

- **User--User-defined (Input) custom variables** that you create by clicking the **Add** button in the **Set Application Variables** dialog box above and selecting **User**. Your application can delete and modify these variables supplied as input to the called diagram. During runtime, these input variables get auto-filled from the calling context. Typically these variables are created on the SubCallflow side to notify the MainCallflow about the Parameter-passing details while designing the application flow. Composer does auto-synchronization of the input variables in the **Subdialog block**. Input variables are also used on the MainCallflow while invoking the VoiceXML application from workflows in case of Voice Treatment execution - computer telephony integration (CTI) scenario ([Play Application](#)).

- **SubCallflow**--Automatically filled from the VXML subdialog-invoking methodology.

Variable Versus Static Data

Many blocks enable the use of variables rather than static data. For example, the **Prompt block** can play the value of a variable as Text-to-Speech. Variables whose values are to be used in other blocks must be declared here so that they appear in the list of available variables in other blocks. The value collected by an **Input block** or a **Menu block** is saved as a session variable whose name is the same as the block Name. Also see information on the **AppState variable** used by the DB Data block.

Entry Block Variables

Entry block variables can access **User Data** (attached data from a routing workflow) from `session.com.genesyslab.userdata` and SIP Request-URI parameters from `session.connection.protocol.sip.requesturi` session variables.

Request URI parameters created in IVR Profiles during the VoiceXML application provisioning are passed to the Composer generated VoiceXML application as request-uri parameters in the `session.connection.protocol.sip.requesturi` session array. An Entry block variable can use these parameters by setting the following expressions to the variable values: `typeof session.connection.protocol.sip.requesturi['var1'] == 'undefined' ? "LocalDefaultValue" : session.connection.protocol.sip.requesturi['var1']`.

If parameters are set as part of IVR Profiles provisioning in the Genesys VoiceXML provisioning system, and if these parameters have the same names as variables set in the Entry block's **Variables** property with the above mentioned `sip.requesturi` expression, then the SIP-Request-URI parameters will take precedence over the user variable values set in the Entry block.

Important

For more information on valid values and syntax for the `gvp.services-parameter` section, refer to page number 121 in the [GVP 8.5 User's Guide](#).

IVR profiles for GVP can be created using the Genesys Administrator. For more information, refer to the [Voice Platform Solution Guide](#) and the `gvp.services-parameter` section in the [GVP 8.5 User's Guide](#).

Attaching Results to User Data

While you can assign Classify object results to a variable, Genesys does not recommend this. The recommended way of dealing with the classification results is to attach them to the interaction. Then User Data will have the keys listed in the table below with the corresponding values returned by Classification Server. As an example, User Data would have the following pairs after the attachment:

Parameter	Value
CtgId	00001a05F5U900QW
CtgRelevancy	95
CtgName	Cooking
CtgId_00001a05F5U900QW	95
CtgId_00001a05F5U900QX	85
CtgId_00001a05F5U900QY	75
CtgId_00001a05F5U900QZ	65

VXML Properties

This page provides details about the properties used to manage platform behavior: Note: Properties apply to their parent tag and all the descendants of the parent. A property at a lower level overrides a property at a higher level. If you already have GVP, note that the properties in defaults-ng.vxml will be (re)set as documented below only when a system is newly installed. If you simply upgrade from a previous release, the old values will be preserved. This means that any manual configuration of defaults-ng.vxml will be saved when you upgrade. It also means that when moving to newer versions in which GVP uses different default values, the defaults will not be reset unless you newly install (rather than upgrade).

Receive External Message

<i>Property</i>	<i>Description</i>	<i>Default Value</i>
com.genesyslab. (GVP extension)	<p>This property specifies whether an external message will be received asynchronously. The valid values are:</p> <ul style="list-style-type: none"> • True--If the value equals true, external messages will be received asynchronously. • False--If the value equals false, external messages will be received synchronously. 	false
com.genesyslab. (GVP extension)	<p>This property specifies whether an external message will be queued or discarded. The valid values are:</p> <ul style="list-style-type: none"> • True--If the value equals true, external messages will be queued. The external message is reflected to the application in the application.lastmessage\$ variable (an ECMAScript object). • False--If the value equals false, external messages will not be delivered as a VoiceXML event (they will be discarded). <p>Note:If no external messages have been received, application.lastmessage\$ is ECMAScript undefined. Only the last</p>	false

	received message is available. To preserve a message for future reference during the lifetime of the application, copy the data to an application-scoped variable.	
--	--	--

Speech Recognizer

Property	Description	Default Value
confidencelevel	Specifies the speech recognition confidence level. Values range from 0.0 (minimum confidence) to 1.0 (maximum confidence). Recognition results are rejected (a nomatch event is thrown) if the confidence level of the results is below this threshold.	0.5
sensitivity	Specifies the level of sensitivity to speech. Values range from 0.0 (least sensitive to noise) to 1.0 (highly sensitive to quiet input).	0.5
speedvsaccuracy	A hint specifying the desired balance between speed versus accuracy when processing a given utterance. Values range from 0.0 (fastest recognition) to 1.0 (best accuracy). Note: The Nuance MRCP engine uses the value of the speedvsaccuracy property to set its proprietary rec.Pruning parameter, using the following algorithm: If x is the speedvsaccuracy value, and $x \leq 0.5$ then $\text{rec.Pruning} = (x * 400) + 600$ else $\text{rec.Pruning} = (x * 800) + 400$	0.5
completetimeout	The length of silence required following user speech before the speech recognizer finalizes a result (either accepting it or throwing a nomatch event). The completetimeout is used when the speech is a complete match of an active grammar and no further words can be spoken.	1s
incompletetimeout	The length of silence required following user speech before the speech recognizer finalizes a result (by either accepting it or throwing a nomatch event). In contrast to completetimeout, the incompletetimeout is used when the speech is an incomplete	1s

	match to an active grammar, or when the speech is a match but it is possible to speak further.	
maxspeechevent	The maximum duration of user speech. If this time elapses before the user stops speaking, the maxspeechevent event is thrown. Note: Refer to your ASR engine documentation for support details.	60s
	Maximum number of results returned by the recognizer. Also represents the maximum size of the application.lastresult\$ array.	1

DTMF Recognizer

Property	Description	Default Value
interdigittimeout	The timeout period allowed between each digit when recognizing DTMF input.	3s
termtimeout	The terminating timeout to use when recognizing DTMF input.	0s
termchar	The terminating DTMF character for DTMF input recognition.	#
com.genesyslab.dtmf.offboard_recognition (GVP extension)	<p>This property makes it possible to use the DTMF Recognizer that comes with your ASR Engine instead of using the one provided by Genesys. The valid values are:</p> <ul style="list-style-type: none"> • True--If the value equals true, offboard DTMF recognition is enabled for the call. • False--If the value equals false, offboard DTMF recognition is disabled for the call. <p>Notes:</p> <ul style="list-style-type: none"> • If the value is invalid, an <code>error.semantic</code> will be thrown. • The recognizer will use the engine specified by the ASR engine property. • If you switch between 	False

	<p>external engines in mid call, any buffered digits will be lost.</p> <p>Important Changes to this setting after the first input in an application session will not have any effect.</p>	
--	--	--

Prompt and Collect

<i>Property</i>	<i>Description</i>	<i>Default Value</i>
inputmodes	<p>Determines which input methods to use. Value is a space separated list of input methods:</p> <ul style="list-style-type: none"> dtmf--allows DTMF sequences as input voice--allows voice as input 	dtmf voice
timeout	<p>Once the prompt has finished playing, the length of time to wait, if no speech or dtmf input occurs, before throwing a noinput event.</p>	10s
universals	<p>Specifies universal command grammars to activate. Value is a space-separated list of all or fewer of the following command grammars:</p> <ul style="list-style-type: none"> cancel--If this grammar is activated, and the caller says "cancel" (or equivalent phrase configured for another language), the cancel event is thrown. exit--If this grammar is activated, and the caller says "exit" (or equivalent phrase configured for another language), the exit event is thrown. help--If this grammar is activated, and the caller says "help" (or equivalent phrase configured for another language), the help event is 	none

	<p>thrown.</p> <p>A setting of none disables universal commands. A setting of all can be used as a short form for activating all 3 command grammars.</p>	
<p>com.genesyslab.asengine (GVP extension)</p>	<p>Specifies the name of the ASR (Automatic Speech Recognition) engine to use. For details about available names, consult with your platform administrator.</p> <p>Note: If this property is not specified, the per call configuration value specified in the vxmli.asr.defaultengine property (see the Genesys Voice Platform 8.1 Configuration Options Reference) will be used. The default is empty string (""). Note: It is valid to specify a particular engine only if that engine is installed for the platform running the application. Otherwise, an error.asr.unknownengine event will be thrown. Note: The configured name for SpeechWorks OSR must be speechworks, otherwise a recognition error will occur.</p>	<p>platform-specific</p>
<p>com.genesyslab.ttsengine (GVP extension)</p>	<p>Specifies the name of the TTS (Text-to-Speech) engine to use (that is, the voice). For details about available names, consult with your platform administrator.</p> <p>Note: If this property is not specified, the per call configuration value specified in the vxmli.asr.defaultengine property (see the Genesys Voice Platform 8.1 Configuration Options Reference) will be used. Note: It is valid to specify a particular engine only if that engine is installed for the platform running the application. Otherwise, an error.tts.unknownengine event will be thrown.</p>	<p>platform-specific</p>
<p>com.genesyslab.endbeep (GVP extension)</p>	<p>Specifies whether a beep should be played at the end of prompts in fields, when bargein is disabled. When bargein is enabled, this attribute has no effect (there is never a beep). Platform owners can access the audio file (endofprompt.vox) in the configured audio path.</p>	<p>false</p>
<p>com.genesyslab.utterancedest (GVP extension)</p>	<p>Specifies the path of the directory to use for saved utterance audio files. The value will be resolved to the configured audio path. This property can be used with the recordutterance</p>	<p>files are written to the tmp directory (may or may not be saved, depending on whether the savetmpfiles property is enabled)</p>

	property. Note: If you specify the utterancedest and enable the savetmpfiles property, the utterance will only be saved under the utterancedest path. It will not also be saved with the other tmp files.	
recordutterance (VoiceXML 2.1 feature)	This property tells the platform to enable recording while simultaneously gathering input from the user. Set to true to enable user utterance to be recorded. Set to false otherwise. Upon completion of user input, the recording shadow variable will be set. Note: The <vxml> version attribute must be specified as 2.1 (or higher) to use this property. Note: If the recordutterance property has been specified in a VoiceXML 2.0 page, it will behave as if it is a VoiceXML 2.1 page.	false
recordutterancetype (VoiceXML 2.1 feature)	This property specifies the audio format to use for recording utterances. Only used with the recordutterance property. GVP currently supports the following types: <ul style="list-style-type: none"> • audio/basic--Raw (headerless) 8kHz 8-bit mono mu-law [PCM] single channel. (G.711) • audio/x-alaw-basic--Raw (headerless) 8kHz 8-bit mono A-law [PCM] single channel. (G.711) • audio/x-wav--WAV (RIFF header) 8kHz 8-bit mono mu-law [PCM] single channel. • audio/x-wav--WAV (RIFF header) 8kHz 8-bit mono A-law [PCM] single channel. 	audio/basic
com.genesyslab.asr.get_swi_literaltimings (GVP extension)	Set to true to allow the special OSR variable, SWI_literalTimings, to be accessed through the application.lastresult\$ variable. Requires com.genesyslab.fieldobject to be set to true. Available with SpeechWorks ASR only.	false
com.genesyslab.tts.<Your vendor	Users will be able to define TTS	

<p><i>specific name</i>> (GVP extension)</p>	<p>vendor-specific global properties in the Entry block. The exact set of property names is not known to Composer and therefore no validations will be performed on the names. The general format of these properties will follow this pattern: com.genesyslab.tts.<property_name></p>	
<p>com.genesyslab.asr.<Your vendor specific name> (GVP extension)</p>	<p>When using GVP's MRCP direct integration with an ASR engine, the VoiceXML application can use this property format to specify arbitrary vendor-specific parameters to be sent to the ASR engine.</p> <p>In the property name, <Your vendor specific name> is replaced with the actual vendor-specific parameter name; and the value of the property must be a valid value for that vendor-specific parameter. For example, to set Nuance's rec.GrammarWeight parameter to 10: <property name="com.genesyslab.asr.rec.GrammarWeight" value="10"/> Notes:</p> <ul style="list-style-type: none"> • Vendor parameter names and values could be case-sensitive. Refer to the vendor documentation to ensure you are using valid names and values. • You can only set a vendor parameter using <property> if the parameter can be set by the ASR engine at runtime. Refer to the vendor documentation to confirm which parameters are runtime-settable. • Once a vendor parameter is set using <property>, the setting will stay in effect for the remainder of the call, unless it is set again later in the VoiceXML application. 	<p>parameter-specific</p>
<p>swiep_*/swirec_* (GVP extension)</p>	<p>Many of OSR's swiep_*/swirec_* configuration parameters can also be set as VoiceXML properties.</p> <p>To find out whether a particular parameter can be set as a property, look it up in the OSR Reference Manual. If the line under the parameter name includes</p>	<p>parameter-specific</p>

	<p>"API" (and if the description mentions SWIepSetParameter() or SWIrecRecognizerSetParameter()), then it can be set as a property. Some of the parameters that are commonly used are:</p> <ul style="list-style-type: none"> • swirec_suppress_event_logging • swirec_suppress_waveform_logging • swirec_audio_environment (OSR 2.0+ only) • swirec_backward_compatible_confidence_scores (OSR 2.0+ only) <p>See the OSR Reference Manual for details about the values/usage for each parameter. These properties are specific to Nuance OSR, and are only supported in GVP's <i>MRCP native</i> integration with OSR. (They are not supported in GVP's MRCP direct integration with OSR, using SWMS.)</p>	
<p>com.genesyslab.logtoasr (GVP extension)</p>	<p>If set to true, this will enable GVP to log data directly to the ASR engine's log. Note: If this property is true, then the <log> tag's level attribute is ignored.</p>	<p>true</p>

Prompt and Collect--Barge-in

GVP supports Recognition Based Barge-in.

<i>Property</i>	<i>Description</i>	<i>Default Value</i>
<p>bargein</p>	<p>Controls whether user input can be collected before prompts have finished playing:</p> <ul style="list-style-type: none"> • true--Any user input can barge in during prompts. • false--No user input can barge in during prompts. 	<p>true</p>
<p>bargeinype</p>	<p>Specifies the bargein type:</p> <ul style="list-style-type: none"> • speech--Any user utterance can barge in the prompt. • hotword (equivalent to recognition)--Only user input that matches a grammar can barge in on the prompt. 	<p>speech</p>

Note: Not all bargeintypes are supported with all ASR engines.

MARK Tag

Composer and GVP support the use of the MARK tag from the [VXML Specs](#) to detect whether or not a barge-in was detected. The Mark tag in VXML is used to set the place in a sequence of prompts and can be used to detect the barge-in position during the playback of prompts.

As described in the [GVP 8.1 Legacy Genesys VoiceXML 2.1 Reference Manual](#), the variable `application.lastresult$` is a read-only session variable that holds information about the last recognition to occur within this application. Additionally, `application.lastresult$[i]` provides the ability to use an array of tags when using N-best recognition.

- The [GVP 8.1 Legacy Genesys VoiceXML 2.1 Reference Manual](#) provides a good reference for the differences between VXML 2.0 and 2.1 tags.
- The [GVP 8.1 Application Migration Guide](#) provides a reference for the delta between the GVP interpreters and mentions the GVP-specific platform extensions.
- Lastly, the [GVP Voice XML Help](#) describes the VoiceXML 2.1 standards and tags supported by GVP version 8.0 and later.

Prompt and Collect--Wakeup Word Spotting Recognition Mode

In GVP's MRCP native integration with Nuance OSR, OSR's "magic word" feature is exposed through the following properties.

<i>Property</i>	<i>Description</i>	<i>Default Value</i>
<code>com.genesyslab.wakeupword</code> (GVP extension)	Specifies whether Wakeup Word Spotting should be used for input in fields, menus, and initials. If set to true, recognition is only performed if input length is between a minimum and maximum length, and (only with Nuance OSR 2.0+) if input matches a grammar.	false
<code>com.genesyslab.wakeupwordminimum</code> (GVP extension)	If <code>com.genesyslab.wakeupword</code> is set to true, this specifies the minimum length that input must be in order for recognition to be performed.	
<code>com.genesyslab.wakeupwordmaximum</code> (GVP extension)	If <code>com.genesyslab.wakeupword</code> is set to true, this specifies the maximum length that input may be in order for recognition to be	

	performed.	
--	------------	--

Prompt and Collect--Magic Word / Selective Barge-in Recognition Modes

With Nuance SWMS 3.1.4+, OSR's "magic word" and "selective barge-in" features are exposed through the following properties. GVP does not have default values for the following properties. If the application specifies them, GVP passes the specified values through to SWMS. Otherwise, GVP does not pass anything to SWMS - in which case, SWMS would use its own default settings (see the SWMS documentation for these details).

Property	Description	Default Value
com.genesyslab.ASR.Recognition-Mode (GVP extension)	<p>Set to hotword to enable the OSR <i>selective barge-in</i> or <i>magic word</i> recognition mode:</p> <ul style="list-style-type: none"> • Selective Barge-in--Only user input that matches a grammar can barge in on the prompt. (This mode is enabled if com.genesyslab.ASR.Hotword-Max-Duration is set to 0.) • Magic Word--Only user input that matches a grammar, and whose duration is between a minimum and maximum length, can barge in on the prompt. (The minimum and maximum utterance lengths are specified by com.genesyslab.asr.Hotword-Min-Duration and com.genesyslab.asr.Hotword-Max-Duration.) <p>For example: <code><property name="com.genesyslab.asr.Recognition-Mode" value="hotword"/></code> Note: After setting this property, the specified mode will remain in effect for all subsequent recognitions (even if the property is not set in subsequent input fields), unless a new mode is explicitly set. So, to switch back to normal recognition mode after using one of the above hotword modes, the application must explicitly set this property back to normal (and not set any of the three related properties listed below). For example: <code><property name="com.genesyslab.asr.Recognition-Mode" value="normal"/></code> (Available with Nuance SWMS 3.1.4+ only.)</p>	

<p>com.genesyslab.asr.Hotword-Min-Duration (GVP extension)</p>	<p>If com.genesyslab.asr.Recognition-Mode is set to hotword, this specifies the minimum length (in ms) that input must be in order for recognition to be performed. For example:</p> <pre><property name="com.genesyslab.asr.Hotword-Min-Duration" value="50"/></pre> <p>If com.genesyslab.asr.Hotword-Max-Duration is set to 0, this property will be ignored.</p>	
<p>com.genesyslab.asr.Hotword-Max-Duration (GVP extension)</p>	<p>If com.genesyslab.asr.Recognition-Mode is set to hotword, this specifies the maximum length (in ms) that input may be in order for recognition to be performed. For example:</p> <pre><property name="com.genesyslab.asr.Hotword-Max-Duration" value="2000"/></pre> <p>If this property is set to 0, the OSR <i>selective barge-in</i> mode will be enabled (for example, no minimum and maximum duration constraints are used, so com.genesyslab.asr.Hotword-Min-Duration will be ignored). Otherwise, the OSR <i>magic word</i> mode will be enabled (for example, the minimum and maximum duration constraints specified by com.genesyslab.asr.Hotword-Min-Duration and com.genesyslab.asr.Hotword-Max-Duration will be used).</p>	
<p>com.genesyslab.asr.Hotword-Confidence-Threshold (GVP extension)</p>	<p>If com.genesyslab.asr.Recognition-Mode is set to hotword, this specifies the speech recognition confidence level that should be used. Values range from 0 (minimum confidence) to 1000 (maximum confidence). Recognition results are rejected (a nomatch event is thrown) if the confidence level of the results is below this threshold.</p> <p>For this property to take effect, you must also set the standard confidencelevel property to an equivalent decimal percentage. For example:</p> <pre><property name="com.genesyslab.asr.Hotword-Confidence-Threshold" value="100"/> <property name="confidencelevel" value="0.1"/></pre>	

Fetching

<i>Property</i>	<i>Description</i>	<i>Default Value</i>
audiofetchhint	<p>Defines when audio files can be fetched:</p> <ul style="list-style-type: none"> • prefetch--audio file may be downloaded when the page is loaded • safe--only load the audio file when needed <p>Currently, all audio is fetched when needed.</p>	prefetch
audiomaxage	Defines maximum acceptable age, in seconds, of cached audio resources.	undefined
audiomaxstale	Defines maximum staleness, in seconds, of expired cached audio resources.	undefined
datafetchhint	<p>Defines when XML data files can be fetched:</p> <ul style="list-style-type: none"> • safe--only load the XML data file when needed <p>Currently, all data files are fetched when needed.</p>	safe
datamaxage	Defines maximum acceptable age, in seconds, of cached XML resources.	undefined
datamaxstale	Defines maximum staleness, in seconds, of expired cached XML resources.	undefined
documentfetchhint	<p>Defines when next document can be fetched:</p> <ul style="list-style-type: none"> • safe--only load the next document when needed <p>Currently, all documents are fetched when needed.</p>	safe
documentmaxage	Defines maximum acceptable age, in seconds, of cached documents.	undefined
documentmaxstale	Defines maximum staleness, in seconds, of expired cached documents.	undefined
grammarfetchhint	Defines when grammar files can be fetched:	prefetch

	<ul style="list-style-type: none"> • prefetch--grammar file may be downloaded when the page is loaded • safe--only load the grammar file when needed <p>Currently, all grammars are fetched when needed.</p>	
grammarmaxage	<p>Defines maximum acceptable age, in seconds, of cached grammar resources.</p> <p>SpeechWorks OSR 1.x does not support this.</p>	undefined
grammarmaxstale	<p>Defines maximum staleness, in seconds, of expired cached grammar resources.</p> <p>SpeechWorks OSR 1.x does not support this.</p>	undefined
objectfetchhint	<p>Defines when objects can be fetched:</p> <ul style="list-style-type: none"> • prefetch--object may be downloaded when the page is loaded • safe--only load the object when needed 	prefetch
objectmaxage	<p>Defines maximum acceptable age, in seconds, of cached object resources.</p>	undefined
objectmaxstale	<p>Defines maximum staleness, in seconds, of expired cached object resources.</p>	undefined
scriptfetchhint	<p>Defines when scripts can be fetched:</p> <ul style="list-style-type: none"> • prefetch--script may be downloaded when the page is loaded • safe--only load the script when needed <p>Currently, all scripts are fetched when needed.</p>	prefetch
scriptmaxage	<p>Defines maximum acceptable age, in seconds, of cached script resources.</p>	undefined
scriptmaxstale	<p>Defines maximum staleness, in</p>	undefined

	seconds, of expired cached script resources.	
fetchaudio	The URI of audio to play while waiting for documents to be fetched.	builtin:background_audio.wav
fetchaudiodelay	The length of time to wait at the start of a fetch delay before playing fetchaudio.	1s
fetchaudiominimum	The minimum length of time to play fetchaudio, once started, even if the fetch result arrives in the meantime.	0s
fetchtimeout	Timeout for fetches. This is not supported when using Nuance(MRCP). An error.badfetch is thrown when a fetch duration exceeds fetchtimeout.	30s

Audio Control

The Audio Control Feature is an extension to VoiceXML. **Note:** Audio control functions are only applied to the currently playing prompt, and not across the queued prompt list. Note: These properties may not work properly for TTS. <tbody></tbody>

<i>Property</i>	<i>Description</i>	<i>Default Value</i>
com.genesyslab.noaudiocontrol (GVP extension)	If this property is set (to any value), the com.genesyslab.audiocontrol property is disabled.	undefined
com.genesyslab.audiocontrol (GVP extension)	(Only used if com.genesyslab.noaudiocontrol is undefined.) Set to true to enable Audio Control during playing of audio. Set to false to disable the feature.	true
com.genesyslab.audio.skipduration (GVP extension)	Sets the duration of audio to be skipped when using the skipahead/skipback features. Note: Time units (s or ms) must be provided.	6000ms
com.genesyslab.audio.skipahead (GVP extension)	Sets the DTMF button for skipping ahead in the audio file/ TTS. The duration skipped depends on the value of the com.genesyslab.audio.skipduration property. If set to "-" or undefined, this feature is disabled.	undefined
com.genesyslab.audio.skipback	Sets the DTMF button for	undefined

(GVP extension)	rewinding the audio file/TTS. The duration rewound depends on the value of the <code>com.genesyslab.audio.skipduration</code> property. If set to - or undefined, this feature is disabled.	
<code>com.genesyslab.audio.louder</code> (GVP extension)	Sets the DTMF button for turning volume up. If set to - or undefined, this feature is disabled. This is not supported with VoIP.	undefined
<code>com.genesyslab.audio.softer</code> (GVP extension)	Sets the DTMF button for turning volume down. If set to - or undefined, this feature is disabled. This is not supported with VoIP.	undefined
<code>com.genesyslab.audio.pause</code> (GVP extension)	Sets the DTMF button for pausing playback temporarily, until the pause button is pressed a second time. If set to- or undefined, this feature is disabled.	undefined
<code>com.genesyslab.audio.stop</code> (GVP extension)	Sets the DTMF button for stopping all queued audio playback. If set to - or undefined, this feature is disabled.	undefined
<code>com.genesyslab.audio.next</code> (GVP extension)	Sets the DTMF button for interrupting the current audio playback, and starting the next audio playback in the queue. If set to - or undefined, this feature is disabled.	undefined
<code>com.genesyslab.audio.faster</code> (GVP extension)	Sets the DTMF button for increasing the rate of audio playback. If set to - or undefined, this feature is disabled. This is not supported with VoIP.	undefined
<code>com.genesyslab.audio.slower</code> (GVP extension)	Sets the DTMF button for decreasing the rate of audio playback. If set to - or undefined, this feature is disabled. This is not supported with VoIP.	undefined

Miscellaneous

<i>Property</i>	<i>Description</i>	<i>Default Value</i>
<code>com.genesyslab.loglevel</code>	The loglevel limits execution of <log> tags to the ones whose	1

(GVP extension)	level attribute have a value up to (including) the loglevel value.	
com.genesyslab.private	<p>This property enables data masking. This means that private data like credit card numbers, social insurance numbers, and so on are converted to asterisks (for example, 123 would be converted to ***). The valid values are:</p> <ul style="list-style-type: none"> • True--If com.genesyslab.equals true, data masking is enabled. The data that is masked includes: - asr_trace (result) - dtmf (digit) - input_end (phrase) - prompt_play (all) - subdialog_start (param_value and URL query string) - eval_cond - eval_expr (expression and value) - eval_var (expression and value) - submit (namelist and URL query string) - link (URL query string) - parse_error (URL query string) - wf_arrived (URL query string) - wf_lookup (URL query string) - event_handler_enter (URL query string) - filling (value) - filled_enter (namelist) • False--If com.genesyslab.equals false, data masking is not enabled. <p>Note: The default value is false. Note: This attribute is overridden by the gvp:private attribute (in the <block>, <field>, <transfer>, <record>, <subdialog>, and <initial> tags).</p>	

Platform

The following properties are specific to GVP. The first three are useful for debugging purposes.

<i>Property</i>	<i>Description</i>	<i>Default Value</i>
com.genesyslab.maintainer.sendwhen	This property indicates if the maintainer email message should be sent. Valid values are: always, never, on_message.	on_message
com.genesyslab.savetmpfiles	The value is interpreted as a	none

	string with a list of words. The words may be: all, none, prompts, inputs, pages, recordings. When a list of keywords is specified, the superset of all the keywords are saved. In particular, this means if someone specifies <code><property name="com.genesyslab.savetmpfiles" value="none inputs" /></code> it is equivalent to specifying <code><property name="com.genesyslab.savetmpfiles" value="inputs"/></code> .	
<code>com.genesyslab.savetmpfilesmode</code>	This property two valid values:immediate or delayed. This property only takes effect when <code>com.genesyslab.savetmpfiles</code> is enabled. If set to immediate the files are written to disk immediately. If set to delayed the files are stored in memory.	immediate
<code>com.genesyslab.onexit.keeptmpfiles</code>	This property specifies whether or not keep temp files around after the VoiceXML session has ended. This property will only have meaning if at least one temp files has been saved. If this value is false, all temp files on the disk will be erased, and any files in memory will be discarded. If this value is true, all temp files on disk will be kept, and files in memory will be flushed to disk.	true
<code>com.genesyslab.maxrecordtime</code>	Defines the default (also the upper limit) for the maxtime attribute of the <code><record></code> tag.	10 minutes

Order of Precedence

To find the property value that will take effect at a particular point in an application, the current form item is checked first (to see if the property is defined there), and enclosing scopes are checked as necessary. Here is the full order of precedence for properties:

1. First, look for a property in the current form item (for example, in `<field>`, `<record>`, `<transfer>`, and so on.). If found, use its value.
2. If not found, check the current form (for example, look directly under `<form>` or `<menu>`). If the property is found, use its value.
3. If not found, check the current document (for example, look directly under `<vxml>`). If the property is

found, use its value.

4. If not found, check the current document's application root document (if specified by `<vxml application="...">` in the current document). If the property is found, use its value.
5. Finally, if not found in any of the above, use the setting from the interpreter context for the current call, which includes the settings in the defaults file (for example, `defaults.vxml`) and hard-coded default values that are used if no value is configured anywhere else.

Voice Block Palette Reference

Composer's **palette** contains the diagram building blocks. The block categories that appear depend on what **tab** is selected above the design area or what workflow or callflow is selected in the Project Explorer. For example, to see blocks for creating GVP voice applications, click a ***.callflow** tab or a callflow in the Project Explorer.

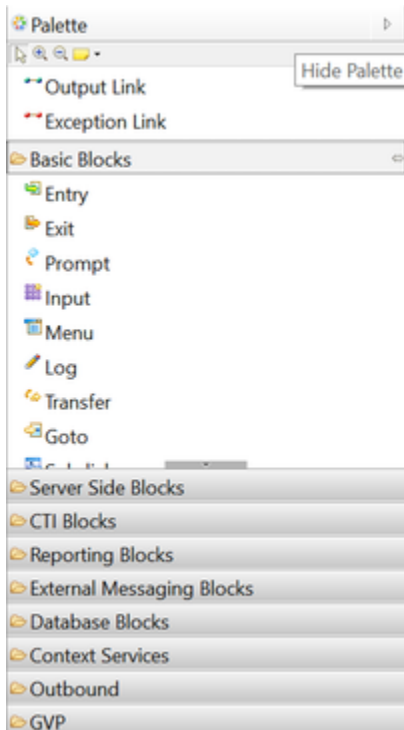

The palette for GVP voice application blocks accesses the following types of blocks:

- **Basic Blocks**
- **Database Blocks**
- **Computer Telephony Integration (CTI) Blocks**
- **External Message Blocks**
- **GVP Blocks**
- **Reporting Blocks**
- **Server-Side Blocks**
- **Outbound Blocks**

Also see [Single Session Treatments](#).

Tip

Should you accidentally cause the palette to disappear, click the Hide/Show Palette triangle

Voice Blocks Basic

The Basic Blocks provide the **GVP VoiceXML** element functionalities used to perform IVR activities and GVP platform extensible object elements:

Basic Blocks

Block Name	Usage
Assign Block	Assign a computed value/expression or an entered value to a variable
Branching Block	Specify multiple application routes based on a branching condition
Disconnect Block	Explicitly hang-up a phone call
End FCR Block	Indicate the end of a recording segment
Entry Block	Begin an application. Only one Entry block can be present in each application. Sets global error (exception) handlers. Defines all global application-level properties, global variables (which appear in the list of available variables for other blocks in the diagram), and global commands. Sets default application scripts and parameters.
Exit Block	End the application
Go To Block	Direct the application to a specific URL
Grammar Menu Block	Uses Grammar Builder files to determine the input options
Input Block	Accepts DTMF or speech input from callers
Log Block	Record information about an application
Looping Block	Iterate over a sequence of blocks multiple times
Menu Block	Collects DTMF and/or speech input from the caller
Prompt Block	Play specific data to the caller
Raise Event Block	Throw custom events
Record Block	Record voice input from the caller
Release ASR Engine	Control when the ASR engine(s) being used in the current session will be released
Set Language Block	Changes the current active language from that set in the Entry block or a previous Set Language block
SNMP Block	Send SNMP traps from the application using the NGI 'dest' extension attribute of the <log> tag
Start FCR Block	Indicate the start of a recorded audio file
Subdialog Block	Invoke VoiceXML subdialogs, which are a mechanism for reusing common dialogs and building libraries of reusable applications.
Transfer Block	Transfer the call to another destination

Block Name	Usage
VXML Form Block	Embed VXML code directly into a callflow diagram with using <subdialog>

Use the [Link tools](#) to connect the blocks.

Assign Common Block

Use the Assign common block to assign a computed value/expression or an entered value to a variable.

See the Query Services block [Service Data](#) property for an example of using the Assign block and Expression Builder to parse a JSON string and assign the service data to a variable.

Function `getSIPHeaderValue(headername)` returns the SIP header value associated with the given SIP headername. You may wish to use this function with the Assign block. By default, this option is disabled for backward compatibility. To set this preference, right-click the Project, select **Properties**, **Default Logging** and check **Log Assign block Variable assignments**. Applicable for both Java and .NET Projects.

Starting with 8.1.440.18, Composer Assign blocks are enhanced to generate logging statements as part of code generation. With this enhancement ORS and MCP logs will show the Assign variables and expressions.

VXML script

```
<assign name="AppState.var0" expr=""This is a callflow diagram file"" />
<log expr=""Assigning variable AppState.var0 with value ' + 'This is a callflow diagram file'"/>
```

SCXML script

```
<script>
  var0 = 'Welcome to workflow diagram';
  __Log('Assigning variable var0 with value ' + 'Welcome to workflow diagram');
</script>
```

A new Project-level property, Default Logging, is added to control this logging capability. By default, this option is disabled for backward compatibility. Applicable for both Java and .NET Projects.

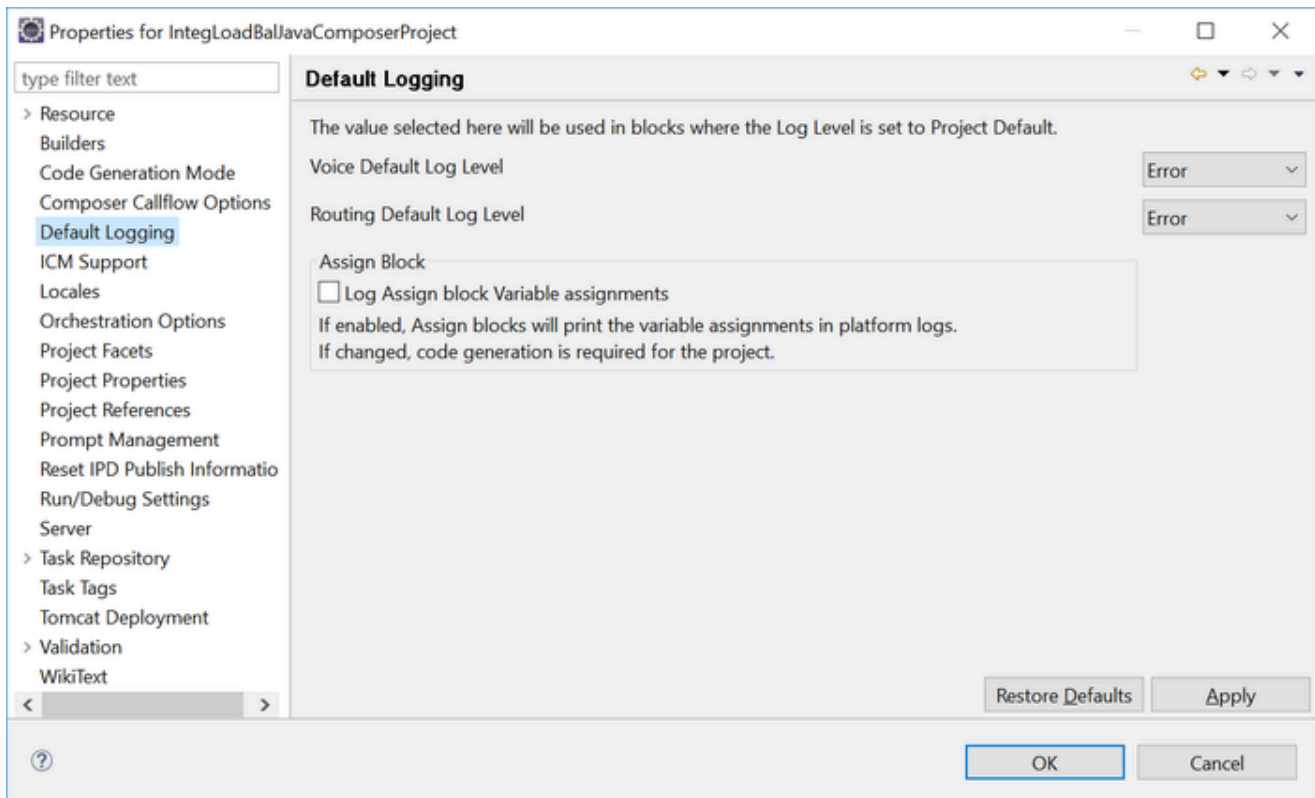

The Assign block has the following properties:

Name Property

Find this property's details under [Common Properties for Callflow Blocks](#) or [Common Properties for Workflow Blocks](#).





Block Notes Property

Find this property's details under [Common Properties for Callflow Blocks](#) or [Common Properties for Workflow Blocks](#).

Assign Data Property



This property assigns a value (expression) to a variable. You select the **variable** and then enter an expression, either a literal or one created in [Expression Builder](#).

To select a variable and assign a value:

1. Click the **Assign Data** row in the block's property table.
2. Click the  button to open the Assign Data to Variables dialog box.
3. Click in the **Variable** field to display a down arrow.
4. Click the down arrow and select a variable whose value will be evaluated to determine the branching condition. Default application variables are described in the [Entry](#) block for voice applications and the [Entry](#) block for routing applications. You can also use a custom variable.
5. Click under Expression to display the  button.
6. Click the  button to open Expression Builder. For examples of how to use Expression Builder, see the [Expression Builder](#) topic.
7. Select an operator for the branching condition. Your variable's value will be equal to (==), less than (<), greater than (>), less than or equal to (<=), greater than or equal to (>=) or not equal to (!=) to value you enter in the Expression field.
8. In the Expression field, create a value to compare to the variable's value. Enclose the value in single quotes (' ').
9. Click the  button to validate the expression. Syntax messages appear under the Expression Builder title.
10. Click **OK** to close Expression Builder and return to the Assign Data to Variables dialog box.
11. You can make multiple variable/value assignments. Click the **Add** button if you wish to add more assignments and repeat the steps above.

Editing Expressions

To edit an expression:

1. Click its row under Expression in the Assign Data to Variables dialog box. This causes the  button to appear.
2. Click the  button to re-open Expression Builder where you can edit the expression.

Exceptions Property

Find this property's details under [Common Properties for Callflow Blocks](#) or [Common Properties for Workflow Blocks](#).

- For callflows, invalid ECMAScript expressions may raise the following exception event: `error.semantic`.
- For workflows, invalid ECMAScript expressions may raise the following exception events: `error.script.SyntaxError`, and `error.script.ReferenceError`.

You can use [custom events](#) to define the ECMAScript exception event handling.

Condition Property

Find this property's details under [Common Properties for Callflow Blocks](#) or [Common Properties for Workflow Blocks](#).

Logging Details Property

Find this property's details under [Common Properties for Callflow Blocks](#) or [Common Properties for Workflow Blocks](#).

Log Level Property

Find this property's details under [Common Properties for Callflow Blocks](#) or [Common Properties for Workflow Blocks](#).

Enable Status Property

Find this property's details under [Common Properties for Callflow Blocks](#) or [Common Properties for Workflow Blocks](#).

Branching Common Block

The Branching block is used for both routing and voice applications. Use the Branching block as a decision point in a callflow or workflow. It enables you to specify multiple application routes based on a branching condition. Depending on which condition is satisfied, the call follows the corresponding application route. A default path is automatically created once the conditions have been defined. If the application cannot find a matching condition, it routes the call to the default flow.

Date/Time Functions

You can open [Expression Builder](#) from the [Condition](#) property and access the following date/time URS functions (**Data Category=URS Functions > Data Subcategory=genesys**):

- `_genesys.session.timeInZone(tzone)`
- `_genesys.session.dayInZone(tzone)`
- `_genesys.session.dateInZone(tzone)`
- `_genesys.session.day.Wednesday`
- `_genesys.session.day.Tuesday`
- `_genesys.session.day.Thursday`
- `_genesys.session.day.Sunday`
- `_genesys.session.day.Saturday`
- `_genesys.session.day.Monday`
- `_genesys.session.day.Friday`

The Branching block has the following properties:

Exceptions Property

The Branching block has no page exceptions.

Name Property

Find this property's details under [Common Properties for Callflow Blocks](#).

Block Notes Property

Find this property's details under [Common Properties for Callflow Blocks](#).

Exceptions Property

Find this property's details under [Common Properties for Callflow Blocks](#). You can also define [custom events](#).

Conditions Property

This property allows you to define scripts for branching conditions and post-processing.

1. Click under **Value** to open the Branch Node setting dialog box.

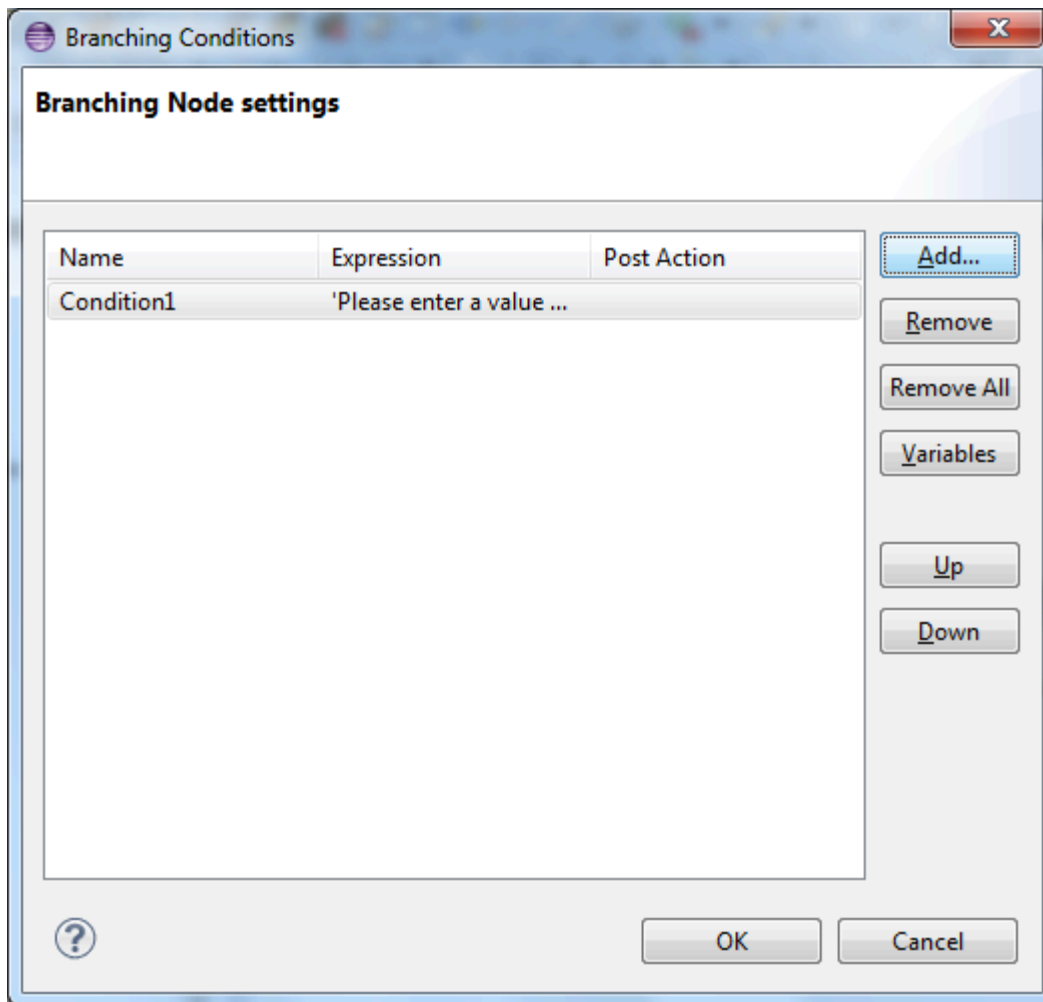

2. Click **Add**.
3. Change the default **Name** to a more descriptive name.
4. Under **Expression**, click under **Value** to open [Expression Builder](#) where you can define a script for a branching expression.
5. Composer 8.1.410.14 adds a new Post Action column. Click opposite **Post Action** to open Expression Builder where you can define a script for post-processing. The post-processing script get executed if the configured option/condition was selected.
6. Click **OK** when done.

Logging Details Property

Find this property's details under [Common Properties for Callflow Blocks](#).

Log Level Property

Find this property's details under [Common Properties for Callflow Blocks](#).

Enable Status Property

Find this property's details under [Common Properties for Callflow Blocks](#).

Disconnect Block

Use the Disconnect block to explicitly hang-up a phone call. It differs from the Exit block as follows:

- When an **Exit block** is used, if the application was called from a CCXML or CTI application, control is sent back to the calling application.
- In the case of the Disconnect block, the entire call is terminated.

Notes

- The Disconnect block returns values (a list of variables) back to the calling context, such as a CCXML application.
- The Disconnect block has no page exceptions.
- There is also a **Disconnect Block** for use in routing workflows as described below.
- Use the routing **Disconnect block** and not this Disconnect block when invoking a callflow as part of a **Play Application** treatment. *GVP 8.x Integration Guide* states the following: For a URS-centric application, the incoming call arrives at a Routing Point DN configured in the SIP Server switch. A routing strategy loading on the Routing Point executes a Play Application treatment to collect customer input. SIP Server sends an INVITE specifying the URI for the voice application. Media Control Platform executes the application. Customer data is collected, then returned to SIP Server in the BYE message. The routing strategy receives the attached data and determines the next action for the call. The call will return to URS where the call can be **disconnected** in the strategy.



The Disconnect block has the following properties:

Name Property

Find this property's details under **Common Properties**.

Block Notes Property

Can be used for both callflow and workflow blocks to add comments. Use this Property to specify a reason for the disconnect. The content can be either an ECMAScript expression created in Expression Builder or free-form text. The string should conform to the standard specified in RFC 3326 (<http://www.ietf.org/rfc/rfc3326.txt>), Reason Header Field for the Session Initiation Protocol (SIP). To use Expression Builder to create the reason:

1. Click under Value to display the  button.
2. Click the  button to open Expression Builder. For examples of how to use Expression Builder, see the

[Expression Builder](#) topic.

Return Values Property

Use this property to specify the variable(s) whose value(s) will be returned once the Disconnect block is executed. To select return variables:

1. Click the Return Values row in the block's property table.
2. Click the  button to open the Return Values dialog box.
3. Select individual **variables**, or click Select all or Deselect all as needed.
4. Click OK to close the Return Values dialog box.

Condition Property

Find this property's details under [Common Properties for Callflow Blocks](#).

Logging Details Property

Find this property's details under [Common Properties for Callflow Blocks](#).

Log Level Property

Find this property's details under [Common Properties for Callflow Blocks](#).

Enable Status Property

Find this property's details under [Common Properties for Callflow Blocks](#).

ORS Extensions Property

Starting with 8.1.4, Composer blocks used to build routing applications (with the exception of the Disconnect and EndParallel blocks) add a new **ORS Extensions** property.

End FCR Block

Use the End FCR block to indicate the end of a recording segment. There must be a matching End FCR block for each [Start FCR](#) block used.

Note: Starting and stopping at tapped points (as marked by the Start FCR block and either EndFCR block or the end of call) depends on the Prompt Queuing feature. For this reason, all Prompts between Start FCR and End FCR should have their [Immediate Playback property](#) set to true.

The End FCR block has the following properties:

The End FCR block has no page exceptions.

Name Property

Find this property's details under [Common Properties](#).

Block Notes Property

Can be used for both callflow and workflow blocks to add comments.

Condition Property

Find this property's details under [Common Properties for Callflow Blocks](#).

Logging Details Property

Find this property's details under [Common Properties for Callflow Blocks](#).

Log Level Property

Find this property's details under [Common Properties for Callflow Blocks](#).

Enable Status Property

Find this property's details under [Common Properties for Callflow Blocks](#).

Entry Block and Variables

Use an Entry block to begin an application. Only one Entry block can be present in each application. The Entry block:

- Sets global error (exception) handlers.
- Defines all global application-level properties, global variables (which appear in the list of available variables for other blocks in the diagram), and global commands. See topic [Variables in Callflows](#).
- Sets default application scripts and parameters.
- [Accesses Expression Builder](#).

The Entry block is used as the entry point for a main callflow or a sub-callflow. It contains the list of all the variables associated with the callflow (referred to as global variables). Note: [Outlinks](#) starting from the Entry block cannot be renamed or assigned a name through the Properties view. The Entry block has the following properties:

Name Property

Find this property's details under [Common Properties](#).

Block Notes Property

Can be used for both callflow and workflow blocks to add comments.

Exceptions Property

Find this property's details under [Common Properties](#). The Entry block has all global exception events, with the defaults of all, connection.disconnect.hangup, and error. Also see [Exception Events](#).

Note on No Input and No Match Events

When selecting exceptions for the Entry block, use both `com.genesyslab.composer.toomanynoinputs` / `com.genesyslab.composer.toomanynomatches` and `noinput/nomatch` to catch all the possible no input and no match events. The selection of `com.genesyslab.composer.toomanynoinputs` / `com.genesyslab.composer.toomanynomatches` is required when `noinput` / `nomatch` exceeds the maximum retries in the lower block. The selection of `noinput` / `nomatch` is required when the lower block does not retry at all.

- `com.genesyslab.composer.toomanynoinputs` occurs when the number of no inputs exceeds the maximum retries in the Menu, Input, DBInput, and Record blocks, and the blocks do not have local

noinput exception ports.

- `com.genesyslab.composer.toomanynomatches` occurs when the number of no matches exceeds the maximum retries in the Menu, Input, DBInput, and Record blocks, and the blocks do not have a local nomatch exception port.

Note on error.badfetch.badxmlpage

NGI no longer supports this event. If upgrading an application from an earlier version of Composer that supported this event in its Entry object, you will need to modify that object via the Exceptions property dialog box.

Application Root Property

- Starting with 8.1.410.14, Composer Projects have a default root VXML file (`ComposerRoot.vxml`) bundled inside the `src` folder. This file, which you can edit to create Project-level defaults such as Input and Menu block variables and values, is present in newly created Projects and upgraded Projects. New Callflow diagrams have this default root VXML document automatically configured in the Application Root property of the Entry block.

You have the option to specify a VXML file to be used as an application root document allowing multiple callflows to share variables. Background: Starting with 8.1.1, each Composer **Project** can have (at most) one root document (VXML file). If a Project has no root document, each callflow is its own stand-alone application. If a Project contains a root document, the set of callflows with Entry blocks that reference that root document make up the application.

- If a callflow or sub-callflow references an application root document, the variables specified in the application root become available for selection in all dialogs in that diagram.
- Variables defined in the application root directly under the `<vxml>` tag become available as global variables to callflows and sub-callflows that access them.

To select an application root document:

1. Click the Application Root row in the block property table.
2. Click the  button to open the Select Resource dialog box.
3. Select the **VXML** file in the Project `src` folder and click OK.

Global Commands Property

The Global Commands property sets rootmap elements for the entire application. A rootmap element is a phrase (user-defined phrase or external grammar) and/or tone the application reacts to at any time the application is running. Use the Global Commands property to set rootmap elements for the entire application. The application uses these rootmap elements as global grammars (subsets of a spoken language that callers are expected to use) in each **Input block**. Composer creates one outport for each rootmap element; the outport specifies the application path in the event to which the rootmap element is matched. Use the Entry block Global Commands property to set rootmap

elements for a subcallflow as well. Note: The RootMap elements defined in the Entry block do not apply to blocks inside a subcallflow. To add, delete, or arrange global phrases, DTMF keys, and grammars:

1. Click the Global Commands row in the block's property table.
2. Click the  button to open the Set Rootmap Commands dialog box.

Fields in Set Rootmap Commands Dialog Box

- Name-- Displays the name of the command.
- DTMF Option--Displays the DTMF key to recognize.
- Phrase-- Displays the phrase to recognize.
- **Grammar**--Displays the built-in or custom grammar used.

Genesys recommends that you use only the GRXML grammar. Otherwise, GSL support--which is not a part of the VoiceXML 2.1 specification--deprecates over time. **Note:** Built-in grammar support for languages other than U.S. English is dependent on the ASR vendor. Before using this feature, make sure that your ASR Engine supports built-in grammars for your language.

Add Button

Use the Add button to enter global phrases, DTMF keys, and grammars.

1. Click Add to enable Command Details fields.
2. In the Name* box, accept the default name or change it.
3. From the DTMF Option drop-down list, select the global DTMF key.
4. In the Phrase box, type the phrase.
5. In the Grammar drop-down list, select a grammar. The grammar source is the custom or built-in grammar for recognition.

Up/Down Buttons

Use the Up and Down buttons to reorder your rootmap elements. Select the element you want to reposition, and then click Up or Down, as necessary.

Delete Button

To delete a phrase, DTMF key, or grammar entry:

1. Select an entry from the list.
2. Click Delete.

Global Properties Property

This property allows suppression of data within the Nuance 9 platform ASR logs. For more information on this property, see the Properties topic on the [Genesys Voice Platform wiki](#). Use Global Properties to select global settings for [VXML properties](#), Automatic Speech Recognition vendor-specific properties or Text-to-Speech vendor-specific properties. To enter properties and values:

1. Click the Global Properties row in the block's property table.
2. Click the  button to open the Global Property Settings dialog box.
3. Click Add to enable the Property Name and Property Value fields.
4. Enter or select a Property Name by doing one of the following:
 - Select the Property Name from the drop-down list, or
 - Type the Property Name in the Property Name field.
5. Enter or select a Property Value by doing one of the following:
 - Select the Property Value from the drop-down list, or
 - Type the Property Value in the Property Value field.
6. Click OK.

Scripts Property

Use the Scripts property for including custom JavaScript includes into the application. The JavaScript functions in the specified .js file can then be used in the Assign or Branching blocks in the expression.

1. For this property, enter the filename of your file (for example: script.js). If there are multiple files to be loaded, you can delimit by using the | character; for example: script1.js|script2.js.
2. Then place the custom ECMAScript file in the Scripts subfolder of your project.

There is also a Global Variable SCRIPTSDIR, which specifies the default folder for the scripts files (and works very similar to VOXFILESDIR for audio files).

Variables Property

Variables can be predefined system variables (provided by Composer, which you cannot delete) or user-defined variables. See the [Variables in Callflows](#) topic for more information. Many Composer blocks have properties that require you to select a variable. **Examples:**

- The following callflow blocks contain a mandatory [Output Result property](#): [Menu](#), [Record](#), [DB Input](#), [Grammar Menu](#), [Input](#), [Get Access Number](#), [Transfer](#), and [Statistics](#). After defining variables in the Entry block, you supply this property by selecting the variable to contain the output result.

- When creating a new voice project, a Project-level flag, Enable_ICM, controls whether ICM variables are available for selection and assignment to variables within Composer's Entry block.
- For information on user data and GVPSessionID, see the [Project Properties dialog box](#), Composer Callflow Option.

To declare for the application or subcallflow:

1. In the Properties tab, click opposite Variables under Value to display the  button.
2. Select **Project**, **System**, or **User** Variables.
3. Click the arrow to display the selected type. An example **System Variables** dialog box is shown below.

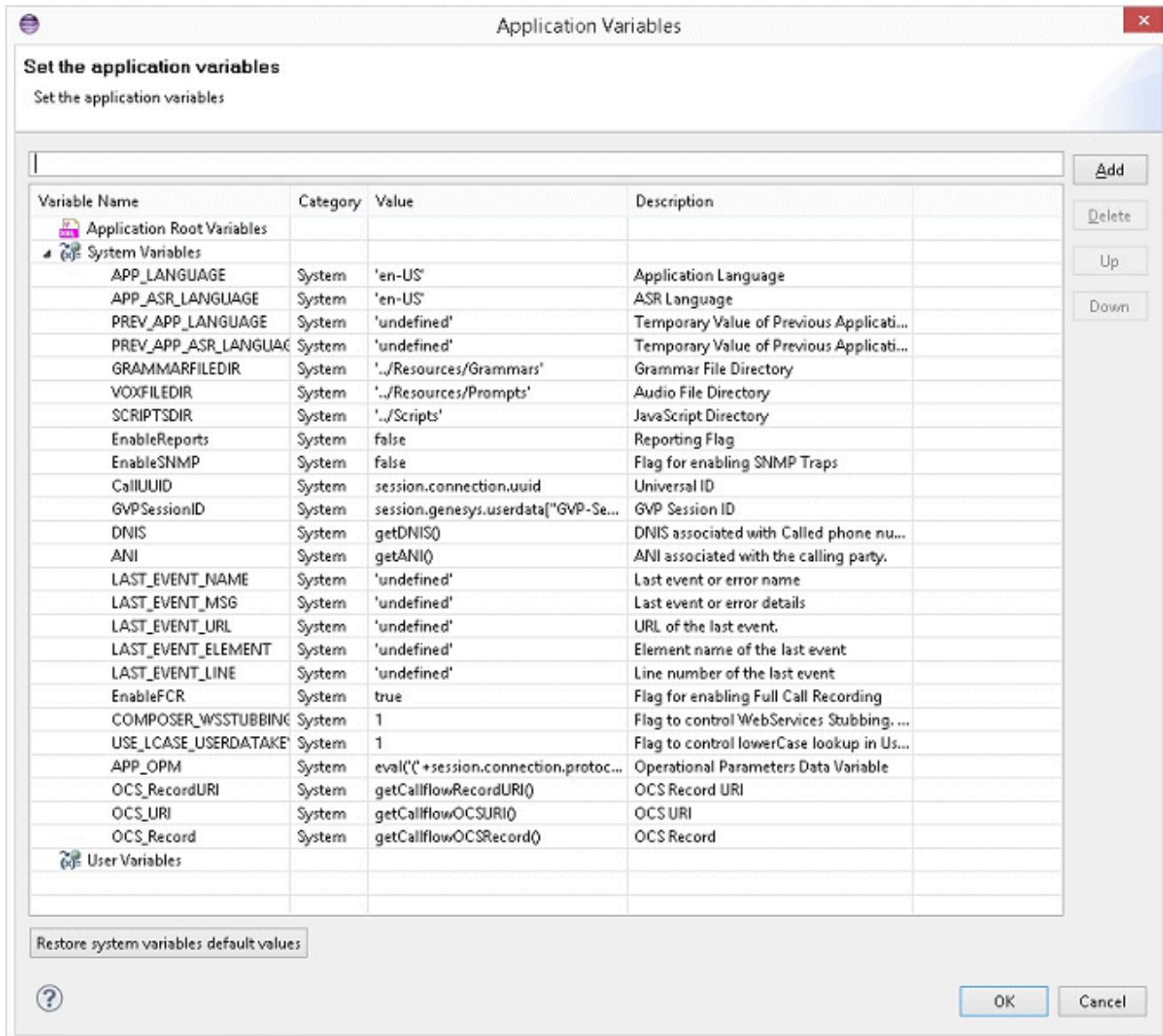

The above figure shows the dialog box after clicking the **Add** button. The Value field for the new variable (Var0) contains a button to access [Expression Builder](#).

GVPSessionID System Variable

Composer Projects have a callflow options property page to control how the GVPSessionID system variable is initialized. It can be used to control if it is initialized from the X-Genesys-GVP-Session-ID SIP header or the `session.com.genesyslab.userdata` object.

Restoring System Variable Default Values

Projects created in earlier versions of Composer may throw runtime errors due to incorrectly initialized system variables after upgrading to Composer 8.1.3. This was due to changes in how system variables were stored and handled in 8.1.3. To resolve this, the Entry block Variables dialog adds a button to restore system variables to default values, which can be used to reset variables and fix initialization. Note that this also removes any custom values set in system variables. As system variables cannot be updated, after clicking the **Restore System Variables Default Values** button, you cannot update the customized system variables.

Starting with 8.1.410.14, you can:

- Invoke the Entry Block variables dialog when a property is selected in the Properties view using ALT+V.
- Enable Composer to automatically declare variables in a Main callflow to match input/output variable names in Sub-callflows and perform the mapping. For more information, see the **auto synchronization** option in [Diagram Preferences](#).

Defining Variables

Important! When defining a variable name, the name:

- Cannot start with **APP_** (callflow diagrams).
- Must not start with a number or underscore.
- May consist of letters, numbers, or underscores.

When you define and initialize a variable that is expected to be played as a date later on in the callflow, define the value using the following format: `yyyymmdd`. Example: `MyDate=20090618`. You must use this format; Composer does not perform any conversions in this case. When you define and initialize a variable that is expected to be played as a time later on in the callflow, define a 12 hour-based value using the following format: `hhmmssa` or `hhmmssp`. Example: `MyTime=115900a` or `MyTime=063700p`. Define a 24 hour-based value using the following format: `hhmmssh` Example: `MyTime=192000h`. You must use this format; Composer does not perform any conversions in this case. If variables are set as part of provisioning by the Genesys VoiceXML provisioning system, and if these variables have the same names as variables set in the Variables property dialog box, the VoiceXML provisioning system values take precedence over the global variables set here. Many blocks enable the use of variables rather than static data. For example, the Prompt block can play the value of a variable as Text-to-Speech. Variables whose values are to be used in other blocks must be declared here so that they appear in the list of available variables in other blocks. The value collected by an Input block or a Menu block is saved as a session variable whose name is the same as the block Name.

System Variables

These variables apply only to the Entry block, unless otherwise indicated.

- **APP_LANGUAGE**--Holds the application language setting. The value should be the RFC 3066 language tag of an installed language pack. Examples of valid RFC 3066 language tags include en-US and fr-FR. This setting also acts as a default language for the application. This variable may be set using the Set Language block for a multilingual application.
- **APP ASR LANGUAGE**--Holds the language locale for ASR resources. You must define this variable if the application needs to use a different language locale for ASR from TTS resources.
- **GRAMMARFILEDIR**--Gives the relative path from the application to the directory that contains the grammar files. By default, it is set to ../Resources/Grammars. If a voice application supports multiple languages, you can enable the application to switch between them, by changing the value of this variable. In the Subcallflow_Start block, the GRAMMARFILEDIR global variables are not defined by default. This allows the subcallflows to inherit the value of this variable from the main callflow. If the subcallflow overrides this value, the variable can be defined in the Subcallflow_Start block. (**Note:** Composer uses the getGrammarURI() function (from **common.js**) to build the grammar URL. If you include *http*, *https*, *file*, *rtsp*, or *rtsp*s, then it will just use the provided URL (that is, the URL is encoded and the resultant grammarURI is generated). If not, it will build a URL based on AppState.GRAMMARFILEDIR).
- **VOXFILEDIR**--Gives the relative path in the application to the directory that contains the audio files (.vox/.wav). By default, it is set to ../Resources/Prompts. If a voice application supports multiple languages, you can enable the application to switch between them, by changing the value of this variable.
- **SCRIPTSDIR**--Default location for JavaScript files
- **EnableReports**--Enables VAR reporting. (Reporting blocks)
- **EnableSNMP**--Enables the SNMP block, if present in the application
- **CallUUID**--Session connection Universal ID
- **GVPSessionID**--The Genesys Userdata Session ID
- **LAST_EVENT_NAME**--Stores the name of the last event or error that was handled in the Entry block.
- **LAST_EVENT_MSG**--Stores the message of the last event or error that was handled in the Entry block
- **LAST_EVENT_URL**--Stores the URL of the last event or error that was handled in the Entry block.
- **LAST_EVENT_ELEMENT**--Stores the element name of the last event or error that was handled in the Entry block
- **LAST_EVENT_LINE**--Stores the line number of the last event or error that was handled in the Entry block
- **EnableFCR**--A flag for enabling Full Call Recording
- **COMPOSER WSSTUBBING**
- **App_OPM**--Used for fetching OPM parameters. Stores JSON content passed by GVP in session variables. Available throughout the callflow diagram. The **OPM block** works with this variable by extracting values from it into application variables. Available for main callflows only.
- **OCS_RecordURI**--Used by **Outbound blocks**. Its default value will be set from userdata passed into the application. For workflows (SCXML):
_genesys.ixn.interactions[InteractionID].udata.GSW_RECORD_URI.For callflows: (VXML)
session.com.genesyslab.userdata.GSW_RECORD_URI.

- **OCS_URI**--Used by **Outbound blocks**. Holds the OCS resource path ([http|https]://<host>:<port>). Its default value will be deduced from OCS_Record_URI. You may change this variable value in order to use a different OCS application for all Outbound blocks in the workflow.
- **OCS_Record**--Used by **Outbound blocks**. Holds the Record Handle value deduced from OCS_Record_URI.

Note: Request URi parameters created in IVR Profiles during the VoiceXML application provisioning are passed to the Composer generated VoiceXML application as request-uri parameters in the `session.connection.protocol.sip.requesturi` session array. An Entry block variable can use these parameters by setting the following expressions to the variable values: `typeof session.connection.protocol.sip.requesturi['var1'] == 'undefined' ? "LocalDefaultValue" : session.connection.protocol.sip.requesturi['var1']`. If parameters are set as part of IVR Profiles provisioning in the Genesys VoiceXML provisioning system, and if these parameters have the same names as variables set in the Entry block's **Variables** property with the above mentioned `sip.requesturi` expression, then the SIP-Request-URI parameters will take precedence over the user variable values set in the Entry block.

Many blocks enable the use of variables rather than static data. For example, the **Prompt** block can play the value of a variable as Text-to-Speech. Variables whose values are to be used in other blocks must be declared here so that they appear in the list of available variables in other blocks. The value collected by an **Input** block or a **Menu** block is saved as a session variable whose name is the same as the block name.

Variable Name

You can use the Variable name field for either of the following purposes:

- To enter the name of a new variable.
- To change the name of an existing variable. To do this, select an existing variable from the list of variables. The variable's name appears in the Variable box, and you can change its value in the Value box.

Excluded Characters

The Variable name field will not accept the following special characters:

- less-than sign (<)
- greater-than sign (>)
- double quotation mark (")
- apostrophe (')
- asterisk (*)
- ampersand (&)
- pound (#)
- percentage (%)
- semi colon (;)
- question mark (?)

- period (.)

The variable Value field will not accept the following special characters:

- less-than sign (<)
- greater-than sign (>)
- double quotation mark (")
- apostrophe (')
- ampersand (&)
- plus sign (+)
- minus sign (-)
- asterisk (*)
- percentage (%)

Condition Property

Find this property's details under [Common Properties for Callflow Blocks](#) or [Common Properties for Workflow Blocks](#).

Logging Details Property

Find this property's details under [Common Properties for Callflow Blocks](#) or [Common Properties for Workflow Blocks](#).

Log Level Property

Find this property's details under [Common Properties for Callflow Blocks](#) or [Common Properties for Workflow Blocks](#).

Enable Status Property

Find this property's details under [Common Properties for Callflow Blocks](#) or [Common Properties for Workflow Blocks](#).

Exit Block

Use the Exit block to end the application. There will usually be an Exit block in every main callflow, unless you use a GoTo block, blind transfer, or other mechanism to end a callflow. Return Mode should be set to false in the main callflow's Exit block. The Exit block is typically connected to the [connection.disconnect.hangup](#) exception handler. It is also connected to the last block in the application (for example, when the application wants to play an error message and terminate the call). You can have multiple Exit blocks inside a callflow. The Exit block has no page exceptions.

Using an Exit Block Inside a Subcallflow

The [Subdialog](#) block is used to create subcallflows, which are VoiceXML subdialogs. An Exit block terminates the subcallflow application. If the control has to be returned to the main application, then the Return Mode property should be set to true and the user can send a list of parameters to the main call flow as the output parameters. Name

Name Property

Find this property's details under [Common Properties](#).

Block Notes Property

Can be used for both callflow and workflow blocks to add comments.

Reason Property

This property is visible only for subcallflows. Enter a reason for the implicit ActionEnd to be used for VAR reporting.

Return Mode Property

This property is visible only for subcallflows. Click the down arrow under Value and select one of the following:

- true to return control back to the calling callflow.
- false to exit the application.

Return Values Property

Use this property to specify the variable(s) whose value(s) will be returned once the Exit block is executed. To select return variables:

1. Click the Return Values row in the block's property table.
2. Click the  button to open the Return Values dialog box.
3. Select individual **variables** (including **ICM** variables if applicable), or click Select all or Deselect all as needed.
4. Click OK to close the Return Values dialog box.

Condition Property

Find this property's details under [Common Properties for Callflow Blocks](#).

Logging Details Property

Find this property's details under [Common Properties for Callflow Blocks](#).

Log Level Property

Find this property's details under [Common Properties for Callflow Blocks](#).

Enable Status Property

Find this property's details under [Common Properties for Callflow Blocks](#).

Result Property

This property is visible only for subcallflows. Click the down arrow and select one of the following to be used for VAR reporting:

- **UNKNOWN**
- **SUCCESS**
- **FAILED**

GoTo Block

Use this block to direct the application to a specific URL. This block enables you to pass parameters in the current application to the URL by selecting them from the User Parameters list. This block is normally used to transfer to another voice application. Genesys recommends that you use subcallflows for modularizing the application and the GoTo block for calling an external application. Note: If an application enables Voice Application Reporting, Genesys recommends that you use subcallflows instead of a GoTo block. The GoTo block has no page exceptions. The GoTo block has the following properties:

Name Property

Please find this property's details under [Common Properties](#).

Block Notes Property

Can be used for both callflow and workflow blocks to add comments.

Condition Property

Find this property's details under [Common Properties for Callflow Blocks](#).

Exceptions Property

Beginning with release 8.1.510.12, the Exceptions property is available in the GoTo block and allows you to define exception events that can be handled within the block.

Find this property's details under [Common Properties for Callflow Blocks](#).

- The error and error .badfetch standard exceptions are supported.
- You can also define [custom events](#).

Logging Details Property

Find this property's details under [Common Properties for Callflow Blocks](#).

Log Level Property

Find this property's details under [Common Properties for Callflow Blocks](#).

Enable Status Property

Find this property's details under [Common Properties for Callflow Blocks](#).

Parameters

Use to select variables/parameters to pass to the target application. Note: If the Type property is set to ProjectFile, the Parameters property does not apply. To select parameters (Type property is set to URL):

1. Click the Parameters row in the block's property table.
2. Click the  button to open the Parameters dialog box.
3. Select individual parameters, or click Select all or Deselect all as needed.
4. Click OK to close the Parameters dialog box.

Type

Sets the type of the destination application. There are two options:

- URL--The destination application can be found at the location specified in the Uri property.
- ProjectFile--The destination can be another location inside the same Composer Project.

To select a value for the Type property:

1. Select the Type row in the block's property table.
2. In the Value field, select URL or ProjectFile from the drop-down list.

URI

Specifies the destination (URL or Composer Project) depending on the value of the Type property. To set a URL destination for the Uri property (Type property is set to URL):

1. Select the Uri row in the block's property table.
2. In the Value field:
 - Type a valid URL, which can be specified as a relative path if the file is in the same project (for example, ../src/WSJNews.vxml).
 - Or select a **variable** from the drop-down list.

To set a Composer Project destination for the Uri property (Type property is set to ProjectFile):

1. Click the Uri row in the block's property table.
2. Click the  button to open the Uri dialog box.
3. Select a Voice Project file in the list.
4. Click OK to close the Uri dialog box.

Fetch Audio Property

Enter the fetchaudio file to play when executing a long-running tasks, such as a server side web query. By default, Next Generation Interpreter (NGI) supplies a built-in fetchaudio file. For information on GVP support of fetchaudio, see:

- Fetching Properties in [GVP Voice XML Help](#).
- The VoiceXML Properties section of the [GVP 8.1 Legacy Genesys VoiceXML 2.1 Reference Manual](#).
- The Prompt block, [VXML Behavior and Queueing of Prompts](#).

Fetch Audio Delay Property

Enter the length of time to wait at the start of a fetch delay before playing fetchaudio. For more information, see Fetching Properties in [GVP Voice XML Help](#)

Fetch Audio Minimum Property

Enter the minimum length of time to play fetchaudio, once started, even if the fetch result arrives in the meantime. For more information, see Fetching Properties in [GVP Voice XML Help](#)

Fetch Hint Property

Select prefetch or safe to define when XML data files can be fetched. Selecting safe indicates to only load the XML data file when needed. For more information, see Fetching Properties in [GVP Voice XML Help](#).

Fetch Timeout Property

Enter the timeout for fetches. This is not supported when using Nuance (MRCP). An error.badfetch is thrown when a fetch duration exceeds fetchtimeout. For more information, see Fetching Properties in [GVP Voice XML Help](#).

Max Age Property

Enter the maximum acceptable age, in seconds, of cached audio resources. For more information, see Fetching Properties in [GVP Voice XML Help](#).

Max Stale Property

Enter the maximum staleness, in seconds, of expired cached audio resources. For more information, see Fetching Properties in [GVP Voice XML Help](#).

Grammar Menu Block

Creating a Simple Grammar Video

Below is a video tutorial on building a simple grammar with the Grammar Menu block.

Important

While the interface for Composer in this video is from release 8.0.1, the steps are the basically the same for subsequent releases.

[Link to video](#)

The Grammar Menu block uses [Grammar Builder](#) files to determine the input options.

Menu Block Exception Events

The Menu block has eight local exception events.

- [error](#)
- [error.noresource](#)
- [maxspeecheventtimeout](#)
- [noinput](#)
- [nomatch](#)
- [error.badfetch.grammar.uri](#)
- [error.badfetch.grammar.syntax](#)
- [error.badfetch.grammar.load](#)

The Grammar Menu block has the following properties:

Name Property

Find this property's details under [Common Properties](#).

Block Notes

Can be used for both callflow and workflow blocks to add comments.

Exceptions

Find this property's details under [Common Properties](#).

Gbuilder File Property

A Gbuilder file is created using [Grammar Builder](#) and may contain grammar-related information for multiple locales in a proprietary format. The Grammar Menu block can work with the Gbuilder file directly. The Gbuilder File property is used to select a Gbuilder file in the project. This step also selects the particular rule Rule ID to use for the Grammar Menu block. Once specified, the Grammar Menu block creates menu options based on the information contained in the specified Rule ID in the selected Gbuilder file. To select a grammar builder file and rule:

1. Select the Gbuilder File row in the block's property view.
2. Click the  button to open the GBuilder File dialog box.

Grammar builder files that are defined for this Composer Project are shown in the GBuilder Files pane on the left. These files are usually located in the project folder path: [VoiceProject] > Resources > Grammars > [locale] > [gbuilderfile].gbuilder . Note: Gbuilder files also contain DTMF information.

1. Select a grammar builder file in the left pane.
2. Rules defined for the selected grammar builder file are displayed in the Rules in selected file pane to the right. Select the rule you want to use in this Grammar Menu block, then click OK.

Your selection automatically populates the information for the following three properties: [Rule Id](#)[Rule Tags](#)[Menu Options](#) Note: The Grammar Menu block does not pick up changes automatically if you change your Gbuilder file. To synchronize the block with the latest changes, click on the Gbuilder File property. In the popup make sure that the correct Gbuilder file and RuleID are selected. Click OK to close the dialog box. Your diagram will now reflect any menu options changes made in the Gbuilder file.

Rule ID Property

The Rule ID property is automatically populated with the rule you selected from the Rules in selected file pane in the GBuilder File dialog box. (Refer to the [Gbuilder File property](#).) This is a read-only property in the properties view.

Rule Tags

The Rule Tags property is automatically populated with the specific rule tags that have been defined for the rule you selected from the Rules in selected file pane in the GBuilder File dialog box. (Refer to the [Gbuilder File Property](#) and [Rule Id property](#).) This is a read-only property in the properties view.

Language

The language set by this property overrides any language set by the [Set Language](#) block, the Project preferences, or the incoming call parameters. The property takes effect only for the duration of this block, and the language setting reverts back to its previous state after the block is done. In the case of the Grammar Menu block, this property affects the language of grammars of TTS output:

1. Click under Value to display a down arrow.
2. Click the down arrow and select English - United States (en-US) or the variable that contains the language.

Condition Property

Find this property's details under [Common Properties for Callflow Blocks](#).

Logging Details Property

Find this property's details under [Common Properties for Callflow Blocks](#).

Log Level Property

Find this property's details under [Common Properties for Callflow Blocks](#).

Enable Status Property

Find this property's details under [Common Properties for Callflow Blocks](#).

Menu Mode

To assign a value to the Menu Mode property:

1. Select the Menu Mode row in the block's property table.
2. In the Value field, select DTMF, Voice, or Hybrid from the drop-down list.

The DTMF format indicates the menu option mode of input will be via the telephone keypad. Note: Grammar Builder treats DTMF as another locale. The Voice format indicates the menu option mode of input will be a voice phrase. The Hybrid menu mode will handle both DTMF and Voice inputs, that is via telephone keypad and voice phrase. Note: If you select the Hybrid menu mode, you will have to provide both voice and DTMF values for all menu options.

Menu Options

The Menu Options property is automatically populated with generated menu items (options) that apply to the selected rule tags in the grammar builder file. You do not modify this property. (Refer to the [Gbuilder File property](#), [Rule ID property](#), and [Rule Tags property](#).) This is a read-only property in the properties view.

Clear Buffer

Use the Clear Buffer property for clearing the DTMF digits in the key-ahead buffer. If it is not set to true, the DTMF digits entered are carried forward to the next block. It is commonly used for applications with multiple menus, enabling the caller to key ahead the DTMF digits corresponding to the menu choices. To assign a value to the Clear Buffer property:

1. Select the Clear Buffer row in the block's property table.
2. In the Value field, select true or false from the drop-down list.

Interruptible

The Interruptible property does not apply to the Record block. This property specifies whether the caller can interrupt the prompt before it has finished playing. To assign a value to the Interruptible property:

1. Select the Interruptible row in the block's property table.
2. In the Value field, select true,false,or DTMF (for DTMF barge-in mode support) from the drop-down list.

Prompts

Find this property's details under [Common Properties](#). Note: When Type is set to Value and Interpret-As is set to Audio, you can specify an HTTP or RTSP URL. When Type is set to Variable and Interpret-As is set to Audio, you can specify a variable that contains an HTTP or RTSP URL. Starting with 8.1.410.14, validation displays a warning message if a resource file does not exist.

Timeout

The Timeout property defines the length of the pause between when the voice application plays the last data in the list, and when it moves to the next block. To provide a timeout value:

1. Select the Timeout row in the block's property table.
2. In the Value field, type a timeout value, in seconds.

Security

When the Security property is set to true, data for this block is treated as private. GVP will consider the data entered by the caller for this block as sensitive and will suppress it in platform logs and metrics. To assign a value to the Security property:

1. Select the Security row in the block's property table.
2. In the Value field, select true or false from the drop-down list.

Output Result

You must use the Output Result property to assign the collected data to a user-defined **variable** for further processing. Note! This property is mandatory. You must select a variable for the output result even if you do not plan on using the variable. If this is not done, a validation error will be generated in the Problems view.

1. Select the Output Result row in the block's property table.
2. In the Value field, click the down arrow and select a variable.

For more information, see [Upgrading Projects/Diagrams](#).

Get Shadow Variables

Shadow variables provide a way to retrieve further information regarding the value of an input item. By setting this property to true, it will expose the block's shadow variable within the callflow. When enabled, the shadow variable will be included in the list of available variables. (For example, the Log block's Logging Details will show GrammarMenu1\$.) A shadow variable is referenced as `blockname$.shadowVariable`, where `blockname` is the value of the input item's name attribute, and `shadowVariable` is the name of a specific shadow variable, for example: `GrammarMenu1$.duration`. To assign a value to the Get Shadow Variables property:

1. Select the Get Shadow Variables row in the block's property table.
2. In the Value field, select true or false from the drop-down list.

Number of Retries Allowed

This property determines how many opportunities the user will be provided to re-enter the value. If Use Last Prompt Indefinitely is set to true, this property has no effect; otherwise, the error.com.genesyslab.composer.toomanynomatches or error.com.genesyslab.composer.toomanynoinputs errors will be raised on reaching the maximum retry limit. To provide a value for the number of retries allowed:

1. Select the Number Of Retries Allowed row in the block's property table.
2. In the Value field, type a value for the number of retries that will be allowed.

Retry Prompts

Find this property's details under [Common Properties](#). A selection can only be made if the Number Of Retries Allowed Property is greater than 0. Starting with 8.1.410.14, validation displays a warning message if a resource file does not exist.

Use Last Reprompt Indefinitely

If you set the Use Last Reprompt Indefinitely property to true, the application uses your last re-prompt as the prompt for all further retries. Therefore, the exception handlers that come out for nomatch and noinput are redundant--even if you set the default exceptions that come out as red dots on the left-side of the block. To assign a value to the Use Last Reprompt Indefinitely property:

1. Select the Use Last Reprompt Indefinitely row in the block's property table.
2. In the Value field, select true or false from the drop-down list.

Use Original Prompts

If you set the Use Original Prompts property to true, in the event of an error requiring a retry, the application first plays back the retry error prompt, and then plays back the original prompt for the block (as specified in the Prompts property). To assign a value to the Use Original Prompts property:

1. Select the Use Original Prompts row in the block's property table.
2. In the Value field, select true or false from the drop-down list.

Use Single Counter For Nomatch And Noinput

If you set the Use Single Counter For Nomatch And Noinput property to true, the application maintains a single combined counter for the nomatch and noinput errors. For example, if the block

has three nomatch retry messages and three noinput retry messages, the user gets three retry attempts. If you do not select this option, the application generates a total of six retries; and the user gets up to six retry attempts while not exceeding three of each type -- noinput or nomatch. Note: This property not available on the Record block. To assign a value to the Use Single Counter For Nomatch And Noinput property:

1. Select the Use Single Counter For Nomatch And Noinput row in the block's property table.
2. In the Value field, select true or false from the drop-down list.

Input Block

The Input block accepts DTMF or speech input from callers. It differs from the [Menu block](#) in that it enables taking input that might not belong to a simple choice list (as for the Menu block). It can be used to collect numerical data; for example, phone numbers, account numbers, amounts, or speech data, such as a Stock name. It uses speech or DTMF grammars to define the allowable input values for the user responses. Built-in system grammars are available for data, such as dates and amount.

Important

Built-in grammars may not be available for all languages. If you specify a language other than U.S. English and refer to an unsupported built-in grammar, a parse error `error.unsupported.builtin` will be thrown.

In case of user input blocks (Menu, Input, Record, Transfer), Composer adds a global variable of type "Block" to the variables list. You can conveniently use this variable for accessing the user input value. Also see [Menu Block](#), [Number of Allowed Attempts Exceeded](#). The Input block has the following properties:

Input Block Exception Events

The Input block has eight exception events:

- `error`
- `error.noresource`
- `maxspeecheadtimeout`
- `noinput`
- `nomatch`
- `error.badfetch.grammar.uri`
- `error.badfetch.grammar.syntax`
- `error.badfetch.grammar.load`

Name Property

Please find this property's details under [Common Properties](#).

Block Notes Property

Can be used for both callflow and workflow blocks to add comments.

Exceptions Property

Find this property's details under [Common Properties](#).

Language Property

The language set by this property overrides any language set by the [Set Language](#) block, the Project preferences, or the incoming call parameters. The property takes effect only for the duration of this block, and the language setting reverts back to its previous state after the block is done. In the case of the Input block, this property affects the language of grammars of TTS output:

1. Click under Value to display a down arrow.
2. Click the down arrow and select English - United States (en-US) or the variable that contains the language.

Condition Property

Find this property's details under [Common Properties for Callflow Blocks](#).

Logging Details Property

Find this property's details under [Common Properties for Callflow Blocks](#).

Log Level Property

Find this property's details under [Common Properties for Callflow Blocks](#).

Enable Status Property

Find this property's details under [Common Properties for Callflow Blocks](#).

Output Result Property

You must use the Output Result property to assign the collected data to a user-defined **variable** for further processing.

Important

This property is mandatory. You must select a variable for the output result even if you do not plan on using the variable. If this is not done, a validation error will be generated in the Problems view.

1. Select the Output Result row in the block's property table.
2. In the Value field, click the down arrow and select a variable.

For more information, see [Upgrading Projects/Diagrams](#).

Clear Buffer Property

Use the Clear Buffer property for clearing the DTMF digits in the key-ahead buffer. If it is not set to true, the DTMF digits entered are carried forward to the next block. It is commonly used for applications with multiple menus, enabling the caller to key ahead the DTMF digits corresponding to the menu choices. To assign a value to the Clear Buffer property:

1. Select the Clear Buffer row in the block's property table.
2. In the Value field, select true or false from the drop-down list.

Interruptible Property

This property specifies whether the caller can interrupt the prompt before it has finished playing. To assign a value to the Interruptible property:

1. Select the Interruptible row in the block's property table.
2. In the Value field, select true,false,or DTMF (for DTMF barge-in mode support) from the drop-down list.

Prompts Property

Find this property's details under [Common Properties](#).

Important

When Type is set to Value and Interpret-As is set to Audio, you can specify an HTTP or RTSP URL. When Type is set to Variable and Interpret-As is set to Audio, you can specify a variable that contains an HTTP or RTSP URL. Starting with 8.1.410.14, validation displays a warning message if a resource file or URL does not exist.

Security Property

When the Security property is set to true, data for this block is treated as private. GVP will consider the data associated with this block as sensitive and will suppress it in platform logs and metrics. Composer uses the `com.genesyslab.private` property for the Security property of callflow blocks. For more information see the [GVP 8.1 Voice XML Help](#).

To assign a value to the Security property:

1. Select the Security row in the block's property table.
2. In the Value field, select true or false from the drop-down list.

Timeout Property

The Timeout property defines the length of the pause between when the voice application plays the last data in the list, and when it moves to the next block. To provide a timeout value:

1. Select the Timeout row in the block's property table.
2. In the Value field, type a timeout value, in seconds.

Grammar Type Property

To assign a value to the Grammar Type property:

1. Select the Grammar Type row in the block's property table.
2. In the Value field, select one of the following from the drop-down list:
 - `builtinBoolean`
 - `builtinCurrency`
 - `builtinDate`
 - `builtinDigits`
 - `builtinNumber`

- `builtinPhone`
- `builtinTime`
- `externalGrammar`

Important

All the `builtinXXX` selections are grammars that are provided by the platform or the ASR Engine. Built-in grammar support for locales other than U.S. English is dependent on the ASR vendor. Before using this feature, make sure that your ASR Engine supports built-in grammars for your locale. This feature has the following critical prerequisites: The ASR Engine must support built-in grammars for that language. Contact your ASR Vendor for details. If the ASR Engine supports the language you want to use, then you must install the Language Pack for that language on the GVP Server.

`builtinBoolean`

Valid inputs include affirmative and negative phrases appropriate to the current locale. DTMF 1 represents "yes," and 2 represents "no." The result is ECMAScript `true` for yes or `false` for no. The value is submitted as the string `true` or the string `false`.

`builtinCurrency`

Valid spoken inputs include phrases that specify a currency amount. For DTMF input, the asterisk (*) character acts as the decimal point. The result is either a string with the format `UUUmm.nn`, where `UUU` is the three-character currency indicator according to ISO standard 4217:1995, or null if not spoken by the caller.

`builtinDate`

Valid spoken inputs include phrases that specify a date, including a month, day, and year. DTMF inputs are: four digits for the year, followed by two digits for the month, and then two digits for the day. The result is a fixed-length date string with format `yyyymmdd`--for example, `20000704`. If the year is not specified, `yyyy` is returned as `????`; if the month is not specified `mm` is returned as `??`; and if the day is not specified `dd` is returned as `??`.

`builtinDigits`

Valid spoken or DTMF inputs include one or more digits, 0--9. The result is a string of digits.

`builtinNumber`

Valid spoken inputs include phrases that specify numbers--for example, one hundred twenty-three, or five point three. Valid DTMF input includes positive numbers entered using digits and the star (*) character (to represent a decimal point). The result is a string of digits from 0-9 and that can optionally include a decimal point (.), and/or a plus sign (+) or minus sign (-).

builtinPhone

Valid spoken inputs include phrases that specify a phone number. DTMF star (*) represents x. The result is a string that contains a telephone number consisting of a string of digits and optionally, the character x to indicate a phone number with an extension--for example, 8005551234x789."

builtinTime

Valid spoken inputs include phrases that specify a time, including hours and minutes. The result is a five-character string in the format hhmmx, where x is either a for AM, p for PM, h to indicate a time specified according to the 24-hour clock, or ? to indicate an ambiguous time. Because there is no DTMF convention for specifying AM/PM, in the case of DTMF input, the result is always end with h or ?. If the field value is subsequently used in a prompt, the value is spoken as a time appropriate to the current locale.

externalGrammar

The application can also define an external grammar. The grammars can be written using the [GRXML Editor](#), or GRXML files can be **imported** into the Composer Project. Look at the User Input Project voice application template in Composer for an example of the use of an external grammar file. **Note for Voice Application Developers** When developing a VoiceXML application, you must set the web server connection timeout so that it is appropriate to the task that the application performs. It should be greater than one or all of the following callflow applications:

- Maximum talk time
- Maximum recording time
- Maximum wait time for a user input

Input Grammar Dtmf Property

Important

Multiple grammars by using "|" is supported only when literal values are used and not for expressions and variables. Also, the grammar file URI must be specified within single quotes.

Use the Input Grammar Dtmf (Dual Tone Multi-Frequency as described below) property to specify the DTMF Grammar for the Input Block. The DTMF Grammar is processed and handled by GVP. In the case of external grammars, this specifies the actual path of the grammar file / resource for DTMF Grammars. This is only valid when the Grammar Type is externalGrammar and Input Mode is dtmf or hybrid. To assign a value to the Input Grammar Dtmf property:

1. Select the Input Grammar Dtmf row in the block's property table.
2. In the Value field, select a value from the drop-down list. >br>

Values are the Voice Application Variables described under the Variables property. You can specify multiple grammars by separating the grammars with the "|" character.

Multiple Inputs:

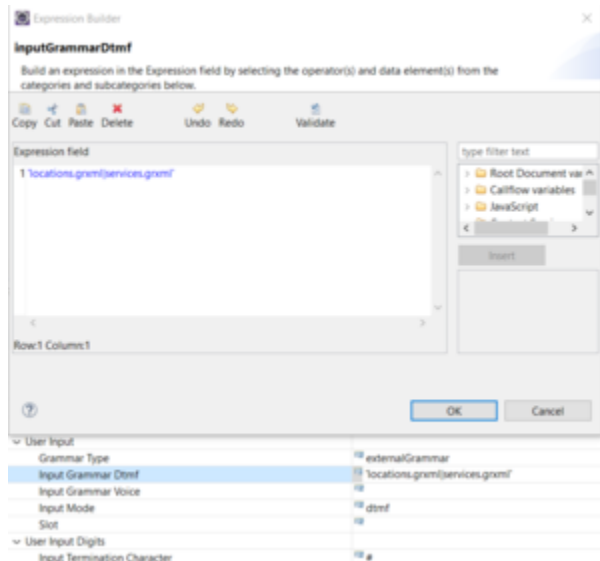

Single Input:

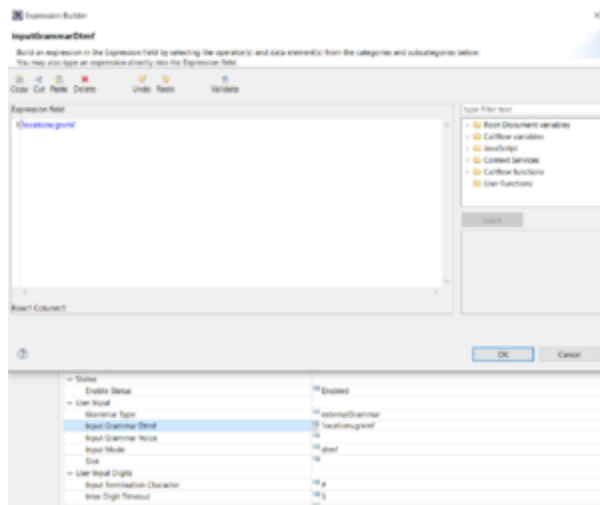

About Dual Tone Multi Frequency (DTMF) Signaling

DTMF signaling is used for telecommunication signaling over analog telephone lines in the voice-frequency band between telephone handsets and other communications devices and the switching center. The version of DTMF used for telephone tone dialing is known by the trademarked term, Touch-Tone. There are some situations where the interpreter (NGI) cannot accept DTMF keypresses immediately as input. In these situations, the keypresses are stored in the DTMF input buffer, for possible later use as input. Throughout the execution of the application, the interpreter must decide whether to save the current contents of the DTMF input buffer (and use them at the next input state),

or to discard them. Buffering DTMF input can be useful in allowing typeahead, where users input DTMF for multiple fields rapidly, separated by the termchar. Whatever input is left after the first termchar, may be used in subsequent fields, meaning that the user does not have to wait to hear each prompt.

Input Grammar Voice Property

Important

Multiple grammars by using "|" is supported only when literal values are used and not for expressions and variables. Also, the grammar file URI must be specified within single quotes.

Use the Input Grammar Voice property to specify the Voice Grammar for the Input block. If you are writing hybrid applications that allow both DTMF and Speech input, specify both the DTMF and Voice grammars. The Voice Grammar is sent to the ASR Engine for processing, whereas the DTMF grammar is processed by GVP. As a result, you need two separate grammars for Voice and DTMF in the case of hybrid applications that allow both Voice and DTMF inputs. In the case of external grammars, this specifies the actual path of the grammar file / resource for ASR Grammars.. This is only valid when Grammar Type is externalGrammar and Input Mode is voice or hybrid. To assign a value to the Input Grammar Voice property:

1. Select the Input Grammar Voice row in the block's property table.
2. In the Value field, select a value from the drop-down list. You can specify multiple grammars by separating the grammars with the "|" character.

Values are the Voice Application Variables described under the Variables Property.

Multiple Inputs:

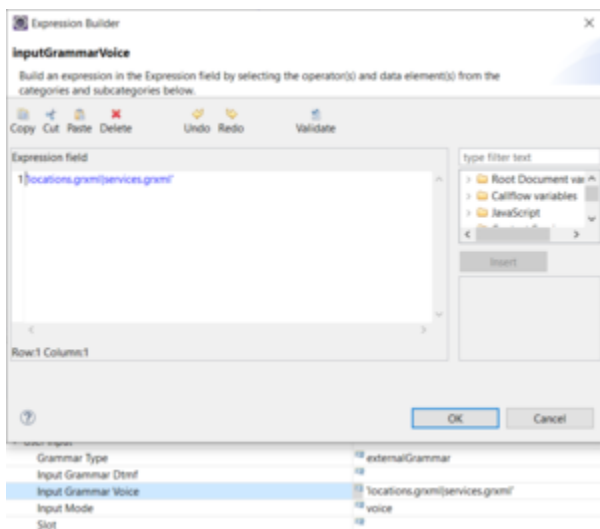

Single Input:

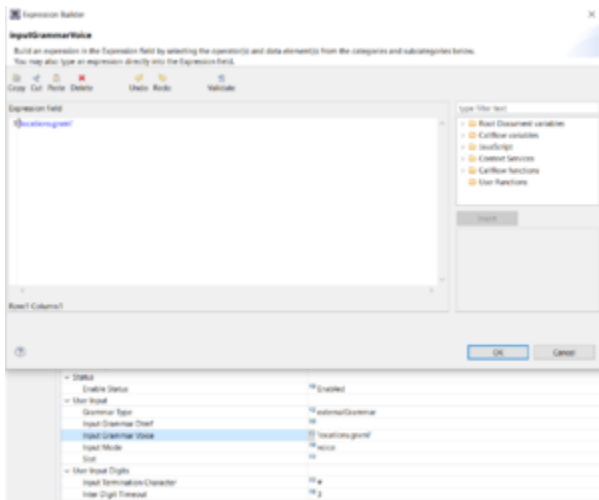

Input Mode Property

To assign a value to the Input Mode property:

1. Select the Input Mode row in the block's property table.
2. In the Value field, select one of the following from the drop-down list:
 - dtmf
 - voice
 - hybrid

DTMF

The DTMF format indicates the menu option mode of input will be via the telephone keypad.

Voice

The Voice format indicates the menu option mode of input will be a voice phrase.

Hybrid

The Hybrid menu mode will handle both DTMF and Voice inputs, that is via telephone keypad and voice phrase.

Slot Property

The Slot property enables you to specify the slot name of the return value from the grammar. If the slot name is not specified, it is assumed that the grammar will return the value of a slot having the same name as the INPUT block itself. To provide a slot name:

1. Select the Slot row in the block's property table.
2. In the Value field, type a slot name that conforms to the restrictions above.

Input Termination Character Property

The Input Termination Character property defines any character that callers can input in order to indicate that they have finished entering data. For example, the prompt given to the caller may say "Enter your account number, and then press the pound key." The pound key is the input-ending character. To provide a value for the input termination character:

1. Select the Input Termination Character row in the block's property table.
2. In the Value field, type a value for a character to represent the end of the input string.

A typical value that is often used, as indicated above, is: # Example:

- To use # or * then type the value as # or *

Warning

Only 1 character can be used as the termination character.

Inter Digit Timeout Property

The Inter Digit Timeout property defines the longest wait time between input characters before a timeout is generated. This is mandatory if dtmf is selected as the Input Mode. Note: Inter Digit Timeout property is applicable only for DTMF input. To provide an Inter Digit timeout value:

1. Select the Inter Digit Timeout row in the block's property table.
2. In the Value field, type a timeout value, in seconds.

Maximum Input Digits Property

Tip

This property only applies if the builtinDigits grammar is selected.

The Maximum Input Digits property defines the maximum number of characters that the caller may input. If the input is variable, an input character such as pound sign (#) should be used to terminate the input. This is mandatory if dtmf is selected as the Input Mode. To provide a value for the maximum number of input digits:

1. Select the Maximum Input Digits row in the block's property table.
2. In the Value field, type a value for the maximum number of input digits.

Minimum Input Digits Property

Tip

This property only applies if the builtinDigits grammar is selected.

The Minimum Input Digits property defines the minimum number of characters that the caller must input. This is mandatory if dtmf is selected as the Input Mode. To provide a value for the minimum number of input digits:

1. Select the Minimum Input Digits row in the block's property table.
2. In the Value field, type a value for the minimum number of input digits.

Get Shadow Variables Property

Shadow variables (optional) provide a way to retrieve further information regarding the value of an input item. By setting this property to true, it will expose the block's shadow variable within the callflow. When enabled, the shadow variable will be included in the list of available variables. (For example, the Log block's Logging Details will show Input1\$.) A shadow variable is referenced as blockname\$.shadowVariable, where blockname is the value of the input item's name attribute, and shadowVariable is the name of a specific shadow variable, for example: Input1\$.duration. Shadow variables can provide platform-related information about the interaction/input. For example, for speech recognition, this may be the confidence level the platform receives from the ASR engine about how closely the engine could match the user utterance to specified grammar. To assign a value to the Get Shadow Variables property:

1. Select the Get Shadow Variables row in the block's property table.
2. In the Value field, select true or false from the drop-down list.

Number Of Retries Allowed Property

The Number Of Retries Allowed property determines how many opportunities the user will be provided to re-enter the value. If Use Last Prompt Indefinitely is set to true, this property has no effect; otherwise, the `error.com.genesyslab.composer.toomanynomatches` or `error.com.genesyslab.composer.toomanynoinputs` errors will be raised on reaching the maximum retry limit. To provide a value for the number of retries allowed:

1. Select the Number Of Retries Allowed row in the block's property table.
2. In the Value field, type a value for the number of retries that will be allowed.

Retry Prompts Property

Find this property's details under [Common Properties](#).

Use Last Reprompt Indefinitely Property

If you set the Use Last Reprompt Indefinitely property to true, the application uses your last reprompt as the prompt for all further retries. In this case the NoMatch and NoInput exception handlers will never get executed, as the retry loop keeps executing forever. To assign a value to the Use Last Reprompt Indefinitely property:

1. Select the Use Last Reprompt Indefinitely row in the block's property table.
2. In the Value field, select true or false from the drop-down list.

Use Original Prompts Property

If you set the Use Original Prompts property to true, in the event of an error requiring a retry, the application first plays back the retry error prompt, and then plays back the original prompt for the block (as specified in the Prompts property). To assign a value to the Use Original Prompts property:

1. Select the Use Original Prompts row in the block's property table.
2. In the Value field, select true or false from the drop-down list.

Use Single Counter For Nomatch And Noinput Property

If you set the Use Single Counter For Nomatch And Noinput property to true, the application maintains a single combined counter for the nomatch and noinput errors. For example, if the block has three nomatch retry messages and three noinput retry messages, the user gets three retry attempts. If you do not select this option, the application generates a total of six retries; and the user gets up to six retry attempts while not exceeding three of each type -- noinput or nomatch.

Tip

This property not available on the Record block.

To assign a value to the Use Single Counter For Nomatch And Noinput property:

1. Select the Use Single Counter For Nomatch And Noinput row in the block's property table.
2. In the Value field, select true or false from the drop-down list.

Log Common Block

Use a Log block to record information about an application. For example, you can log caller-recorded input collected while an application is running or error messages. You can use the Log block for any of the following purposes:

1. Informational - To log the application specific data
2. Error - for logging error details
3. Warning - to flag any warnings
4. Debug - for debugging

The categories in the Log Level property correspond to the above.

When used for a callflow, the Log block writes the log to the Genesys Voice Platform logs (Media Control Platform) using the VoiceXML `<log>` tag.

The Log block has the following properties:

The Log block has no page exceptions.

Name Property

Find this property's details under [Common Properties for Callflow Blocks](#) or [Common Properties for Workflow blocks](#).

Block Notes Property

Find this property's details under [Common Properties for Callflow Blocks](#) or [Common Properties for Workflow Blocks](#).

Exceptions Property

Find this property's details under [Common Properties for Callflow Blocks](#) or [Common Properties for Workflow Blocks](#).

For callflows, invalid ECMAScript expressions may raise the following exception events: `error.semantic`. For workflows, invalid ECMAScript expressions may raise the following exception events:

- `error.log.ReferenceError`

- `error.illegalcond.SyntaxError`
- `error.illegalcond.ReferenceError`

You can use [custom events](#) to define the ECMAScript exception event handling.

Condition Property

Find this property's details under [Common Properties for Callflow Blocks](#) or [Common Properties for Workflow Blocks](#).

Label Property

This property applies to workflows only. It provides meta-data for the logging details.

Logging Details Property

Find this property's details under [Common Properties for Callflow Blocks](#) or [Common Properties for Workflow Blocks](#).

Log Level Property

Find this property's details under [Common Properties for Callflow Blocks](#) or [Common Properties for Workflow Blocks](#).

Enable Status Property

Find this property's details under [Common Properties for Callflow Blocks](#) or [Common Properties for Workflow Blocks](#).

ORS Extensions Property

Starting with 8.1.4, Composer blocks used to build routing applications (with the exception of the Disconnect and EndParallel blocks) add a new [ORS Extensions](#) property.

Looping Common Block

Use this block to iterate over a sequence of blocks multiple times in the following scenarios:

1. Iterate over a sequence of blocks based on a self-incrementing counter (FOR).
2. Iterate indefinitely until an exit condition is met (WHILE).
3. Iterate over records/data returned by the [DB Data block](#) (CURSOR/FOREACH). Also, populate variables if variables mapping is defined.
4. Iterate over data returned by [Context Services blocks](#) (FOREACH). Also, populate variables if [Variables Mapping](#) is defined.
5. Iterate over JSON Array defined in the application.

For scenarios 1 and 2 above, use the Looping block with a reference to the block retrieving the data. Scenarios 3 and/or 4 can be used in conjunction with 1 or 2, in which case the loop will exit when either of the exit conditions is met.

Prerequisite

You must perform the following steps in order for the Looping block to be used to iterate over data returned by the DB Data block:

1. Create a folder named Scripts in the Project folder.
2. In the Entry block, specify a value for the Scripts property such as `../include/DBRecordSetAccess.js`

The Looping block has the following properties:

Name Property

Find this property's details under [Common Properties for Callflow Blocks](#) or [Common Properties for Workflow Blocks](#).

Block Notes Property

Find this property's details under [Common Properties for Callflow Blocks](#) or [Common Properties for Workflow Blocks](#).

Counter Initial Value Property

A Counter variable controls the number of loops. Specify the initial value by entering a positive integer (including zero) or selecting the variable that contains the initial value. Composer will increment the Counter variable after each iteration. The value of the Counter variable is available after the looping has exited. This is a mandatory property if the Counter Variable property is specified.

Counter Variable Property

Enter a name for the variable used to store the Counter value or select the variable that contains the name. This is a mandatory property if the Counter Initial Value property is specified.

Current Record Variable Property

Select a variable to be used to store the current record when iterating over records. Composer will assign the current record after each iteration. This property is ignored if the Data Source Property is not set

Data Source Property

Specify a block reference to the DB Data or a Context Services block (with [Variables Mapping](#) support) that provides the data to be iterated or select the variable that contains a JSON Array. This is a mandatory property if Counter Initial Value and Counter Variable are not specified.

Exceptions Property



Find this property's details under [Common Properties for Callflow Blocks](#) or [Common Properties for Workflow Blocks](#). You can also define [custom events](#).

Counter Max Value Property

Specify the maximum value by entering a positive integer greater than the initial value or selecting the variable that contains the maximum value. When the Counter variable reaches the maximum value, then the block connected to the Exit port is executed. This is a mandatory property if the Counter Variable property is specified or if the Data Source property is not specified.

Exit Expression Property

This property is optional. If specified, prior to each iteration the exit expression is evaluated. If true, the flow goes out via the Exit port of the block. This condition is used in conjunction with max records (if Data Source is specified) or Counter Max Value (if Counter Variable is specified). To enter an exit expression

1. Opposite the **Exit Expression** property, click under **Value** to display the  button.
2. Click the  button to open Expression Builder. For examples of how to use Expression Builder, see the [Expression Builder](#) topic.
3. Create the exit expression and click **OK**.

Condition Property

Find this property's details under [Common Properties for Callflow Blocks](#) or [Common Properties for Workflow Blocks](#).

Logging Details Property

Find this property's details under [Common Properties for Callflow Blocks](#) or [Common Properties for Workflow Blocks](#).

Log Level Property

Find this property's details under [Common Properties for Callflow Blocks](#) or [Common Properties for Workflow Blocks](#).

Enable Status Property

Find this property's details under [Common Properties for Callflow Blocks](#) or [Common Properties for Workflow Blocks](#).

ORS Extensions Property

Starting with 8.1.4, Composer blocks used to build routing applications (with the exception of the Disconnect and EndParallel blocks) add a new [ORS Extensions](#) property.

Using the Looping Block (Counter-based without a Data Source)

1. Add a Looping block and connect the previous block output to the Looping block.
2. Connect the Next output to the sequence of connected blocks.
3. Connect the output of the last block in the sequence in step 2 back to the looping block to form a loop.
4. Connect the Exit output of the looping block to the block(s) to continue processing after the loop has exited. The diagram when a looping block is used should appear as follows:

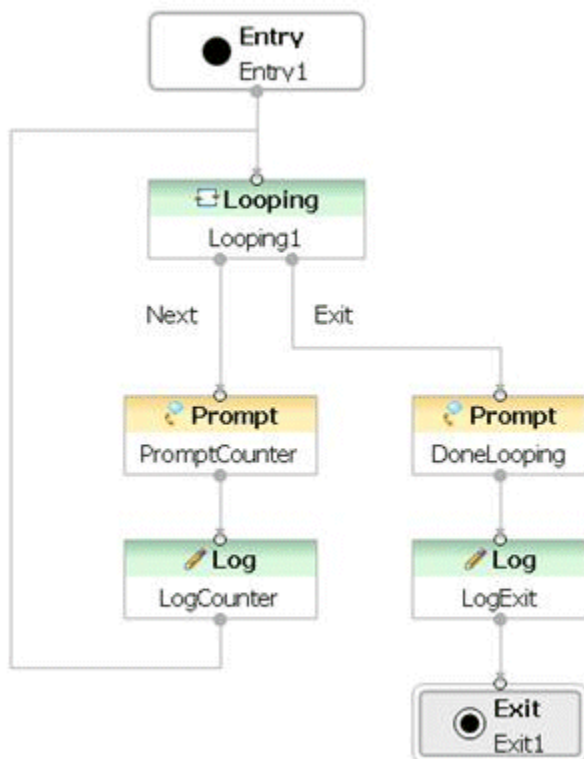

FOR loop: To iterate over the PromptCounter block 10 times, the following properties are set:

1. Counter Initial Value is 1.
2. Counter Variable Name is Variable(MyCounterVariable).
3. Counter Max Value is 10.

WHILE loop: To iterate over the PromptCounter block until a condition is satisfied, the following property is set: Exit expression is loginSuccessful != true.

Using the Looping Block with a DB Data/Context Services Block

1. Add a Looping block and connect the DB Data/Context Services block output to the Looping block.
2. Connect the Next output to the sequence of connected blocks.
3. Connect the output of the last block in the sequence in step 2 back to the looping block to form a loop.
4. Connect the Exit output of the looping block to the block(s) to continue processing after the loop has exited. The diagram when a looping block is used should appear as follows:

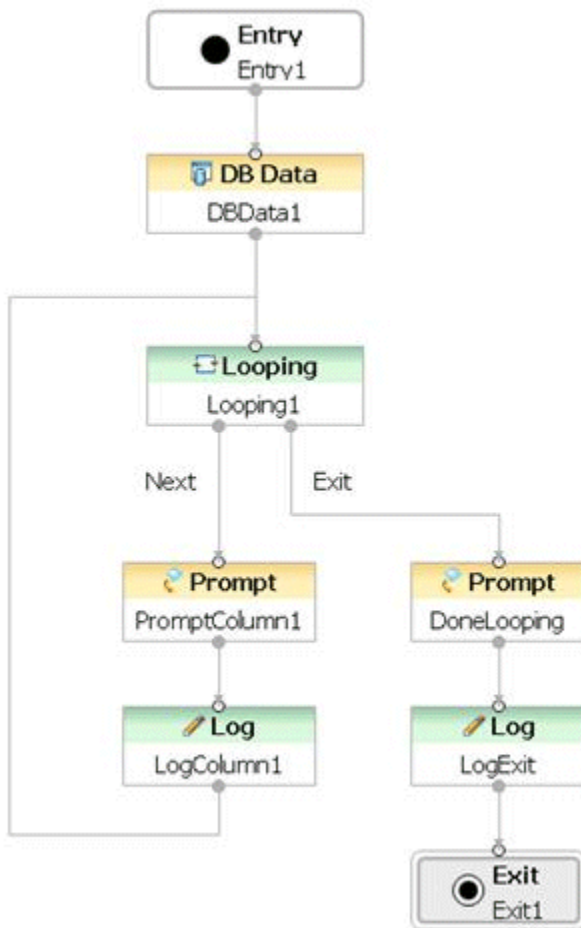

CURSOR/FOREACH loop: To iterate over the PromptColumn1 block for each record returned by the DBData1 block, the following property is set: Data Source = Block Reference (DBData1) This example assumes variables were mapped for Column1 in DB Data1. If variables were not mapped, then another Assign block would be needed to store the value into a variable and the variable is then specified in the PromptColumn1 block.

Menu Block

The Menu block collects DTMF and/or speech input from the caller. Typically, you use it for directed input choices (such as selecting to pay bills, get account balances, and so on) so that users are directed to the correct place in the application to perform their transactions, talk to an operator, or other options. In case of speech applications, tones can be associated with phrases to allow either speech or DTMF input from the caller. The phrases and tones are defined in the Menu tab. In case of user input blocks (Menu, Input, Record, Transfer), Composer adds a global variable of type "Block" to the variables list. You can conveniently use this variable for accessing the user input value. The Menu block has the following properties:

Menu Block Exception Events

The Menu block has four local exception events as described in [Exception Events](#).

- error
- error.noresource
- noinput
- nomatch

Number of Allowed Retries Exceeded

Assume you need to configure the following use case:

1. User is allowed one invalid entry attempt and one no input attempt. User will then be re-prompted and given a chance to repeat the attempt.
2. When all allowed attempts are exceeded, the user hears a prompt (something like You have exceeded the number of possible retries; please call us later when you have correct information. Good bye).
3. At this point, the call should be terminated (or transferred to an agent or some other action taken).

To handle step 2 during application design: In Menu/Input blocks, move exceptions (nomatch, noinput) to supported events. You can then define the flow path(s) for the case when number of attempts is exceeded. The callflow below illustrates this configuration:

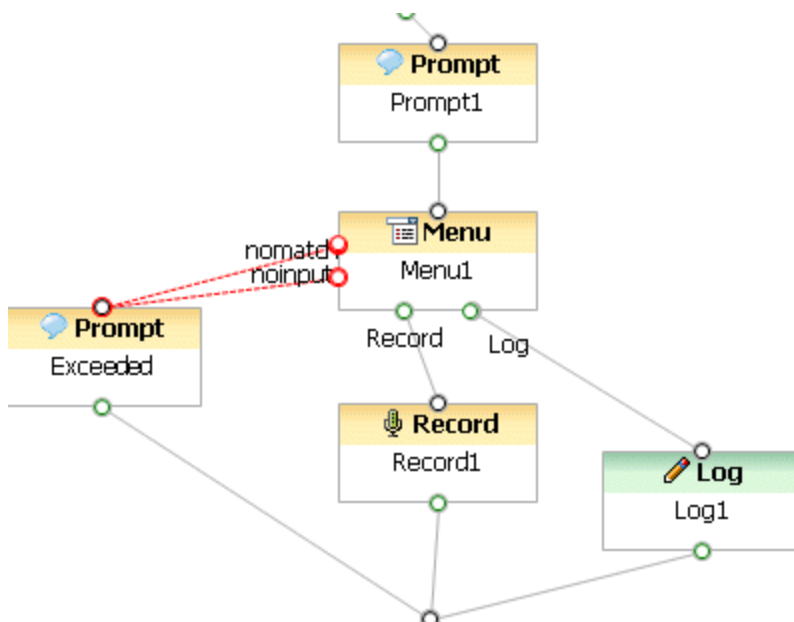

Name Property

Please find this property's details under [Common Properties](#).

Block Notes Property

Can be used for both callflow and workflow blocks to add comments.

Exceptions Property

Find this property's details under [Common Properties](#).

Language Property

The language set by this property overrides any language set by the [Set Language](#) block, the Project preferences, or the incoming call parameters. The property takes effect only for the duration of this block, and the language setting reverts back to its previous state after the block is done. In the case of the Menu block, this property affects the language of grammars of TTS output:

1. Click under **Value** to display a down arrow.
2. Click the down arrow and select English - United States (en-US) or the variable that contains the

language.

Condition Property

Find this property's details under [Common Properties for Callflow Blocks](#).

Logging Details Property

Find this property's details under [Common Properties for Callflow Blocks](#).

Log Level Property

Find this property's details under [Common Properties for Callflow Blocks](#).

Enable Status Property

Find this property's details under [Common Properties for Callflow Blocks](#).

Menu Mode Property

To assign a value to the Menu Mode property:

1. Select the Menu Mode row in the block's property table.
2. In the **Value** field, select one of the following from the drop-down list:

DTMF

The DTMF format indicates the menu option mode of input will be via the telephone keypad.

Voice

The Voice format indicates the menu option mode of input will be a voice phrase.

Hybrid

The Hybrid menu mode will handle both DTMF and Voice inputs, that is via telephone keypad and voice phrase. Note: If you select the Hybrid menu mode, you will have to provide both voice and

DTMF values for all menu options.

Menu Options Property

Use the Menu Options property to add phrases and/or tones to the VoiceMap. To add, delete, or arrange menu options:

1. Click the Menu Options row in the block's property table.
2. Click the  button to open the Menu Options dialog box. Available Menu Details fields depend on the option selected in the Menu Mode property.

For DTMF mode:

- Name*-- Displays the name of the menu option.
- DTMF-Option*--Indicates where the option appears on the menu (1 for first option, 2 for second option, and so on).
- Return Value*--Displays the menu option's return value.
- Post Action*--Specify a script (optional).

For Voice mode:

- Name*-- Displays the name of the menu option.
- Voice-Option*--Allows input of a voice phrase that will be played for the menu option.
- Return Value*--Displays the menu option's return value.
- Post Action*--Specify a script (optional).

For Hybrid mode:

- Name*-- Displays the name of the menu option.
- DTMF-Option*--Indicates where the option appears on the menu (1 for first option, 2 for second option, and so on).
- Voice-Option*--Allows input of a voice phrase that will be played for the menu option.
- Return Value--Displays the menu option's return value.
- Post Action*--Specify a script (optional).

Menu Options Table

In a new Menu block, four menu options populate the Menu Options table by default. To set or change one of the existing menu options:

1. Select a menu option in the Menu Options table to enable Menu Options fields.

2. In the **Name*** box, change the default name to a more descriptive name.
3. From the DTMF-Option* drop-down list, select a numeric value to indicate the order that this option will appear in the menu.
4. In the **Return Value** box, type a return value for this menu option.
5. Composer 8.1.410.14 adds a new **POST ACTION** column. Click to open Expression Builder where you can define a script for post-processing. The Post processing script get executed if the configured option/condition was selected.

Add Button

Use the **Add** button to add a new menu option.

1. In the Name* box, change the default name to a more descriptive name.
2. From the DTMF-Option* drop-down list, select a numeric value to indicate the order that this option will appear in the menu.
3. In the Return Value box, type a return value for this menu option.

Up/Down Buttons

Use the Up and Down buttons to reorder your menu option elements. Select the element you want to reposition, and then click Up or Down, as necessary.

Delete Button

To delete a menu option:

1. Select an entry from the list.
2. Click Delete.

Repeat Menu Option Property

Use for specifying a Repeat **DTMF** key that will cause the menu to be replayed to the caller, from the beginning. The generated VXML will use a <reprompt/> when this DTMF is entered by the caller.

Composer's variable support and **application root** document support allows specifying the same key across blocks. To enable the re-prompting functionality for both DTMF and ASR, you can connect a Menu block output back to the Menu block itself. To specify:

1. Click the Repeat Menu Options row in the block's property table.
2. Click the  button to open the Repeat Menu Options dialog box.
3. Click **Add**.
4. Name the option.
5. Click the down arrow and select a number to indicate where the option appears on the menu (1 for first option, 2 for second option, and so on).

6. Specify the menu option's return value.
7. Click **OK**.

Use Utterance to Segment Property

Select **true** or **false**. You can use this property for Menu block segmentation based on input utterance (the raw string of words that were recognized by the platform). If set to false, Menu block segmentation is based on menu options or return values.

Output Result Property

You must use the Output Result property to assign the collected data to a user-defined **variable** for further processing. Note! This property is mandatory. You must select a variable for the output result even if you do not plan on using the variable. If this is not done, a validation error will be generated in the Problems view.

1. Select the Output Result row in the block's property table.
2. In the **Value** field, click the down arrow and select a variable.

For more information, see [Upgrading Projects/Diagrams](#).

Security Property

When the Security property is set to true, data for this block is treated as private. GVP will consider the data associated with this block as sensitive and will suppress it in platform logs and metrics. To assign a value to the Security property:

1. Select the Security row in the block's property table.
2. In the **Value** field, select true or false from the drop-down list.

Clear Buffer Property

Use the Clear Buffer property for clearing the DTMF digits in the key-ahead buffer. If it is not set to true, the DTMF digits entered are carried forward to the next block. It is commonly used for applications the caller is familiar with. For example, the caller hears a welcome prompt but knows the next prompt will solicit the caller's input or menu selection. The caller may start inputting with dtmf while the welcome prompt plays and expect the input to carry forward. To assign a value to the Clear Buffer property:

1. Select the Clear Buffer row in the block's property table.
-

2. In the **Value** field, select true or false from the drop-down list.

Interruptible Property

This property specifies whether the caller can interrupt the prompt before it has finished playing. To assign a value to the Interruptible property:

1. Select the Interruptible row in the block's property table.
2. In the Value field, select true,false,or DTMF (for DTMF barge-in mode support) from the drop-down list.

Prompts Property

Find this property's details under [Common Properties](#). Note: When Type is set to Value and Interpret-As is set to Audio, you can specify an HTTP or RTSP URL. When Type is set to Variable and Interpret-As is set to Audio, you can specify a variable that contains an HTTP or RTSP URL. Starting with 8.1.410.14, validation displays a warning message if a resource file does not exist.

Timeout Property

The Timeout property defines the length of the pause between when the voice application plays the last data in the list, and when it moves to the next block. To provide a timeout value:

1. Select the Timeout row in the block's property table.
2. In the **Value** field, type a timeout value, in seconds.

Get Shadow Variables Property

Shadow variables (optional) provide a way to retrieve further information regarding the value of an input item. By setting this property to true, it will expose the block's shadow variable within the callflow. When enabled, the shadow variable will be included in the list of available variables. (For example, the Log block's Logging Details will show Menu1\$.) A shadow variable is referenced as blockname\$.shadowVariable, where blockname is the value of the input item's name attribute, and shadowVariable is the name of a specific shadow variable, for example: Menu1\$.duration. Shadow variables can provide platform-related information about the interaction/input. For example, for speech recognition, this may be the confidence level the platform receives from the ASR engine about how closely the engine could match the user utterance to specified grammar. To assign a value to the Get Shadow Variables property:

1. Select the Get Shadow Variables row in the block's property table.
 2. In the **Value** field, select true or false from the drop-down list.
-

Number of Allowed Attempts Exceeded Property

Determines how many opportunities the user will be provided to re-enter the value. If Use Last Prompt Indefinitely is set to true, this property has no effect; otherwise, the `error.com.genesyslab.composer.toomanynomatches` or `error.com.genesyslab.composer.toomanynoinputs` errors will be raised on reaching the maximum retry limit. To provide a value for the number of retries allowed:

1. Select the Number Of Retries Allowed row in the block's property table.
2. In the **Value** field, type a value for the number of retries that will be allowed.

Retry Prompts Property

Find this property's details under [Common Properties](#).

Use Last Reprompt Indefinitely Property

If you set the Use Last Reprompt Indefinitely property to true, the application uses your last reprompt as the prompt for all further retries. Therefore, the exception handlers that come out for nomatch and noinput are redundant--even if you set the default exceptions that come out as red dots on the left-side of the block. To assign a value to the Use Last Reprompt Indefinitely property:

1. Select the Use Last Reprompt Indefinitely row in the block's property table.
2. In the **Value** field, select true or false from the drop-down list.

Use Original Prompts Property

If you set the Use Original Prompts property to true, in the event of an error requiring a retry, the application first plays back the retry error prompt, and then plays back the original prompt for the block (as specified in the Prompts property). To assign a value to the Use Original Prompts property:

1. Select the Use Original Prompts row in the block's property table.
2. In the **Value** field, select true or false from the drop-down list.

Use Single Counter For Nomatch And Noinput Property

If you set the Use Single Counter For Nomatch And Noinput property to true, the application maintains a single combined counter for the nomatch and noinput errors. For example, if the block has three nomatch retry messages and three noinput retry messages, the user gets three retry attempts. If you do not select this option, the application generates a total of six retries; and the user

gets up to six retry attempts while not exceeding three of each type -- noinput or nomatch. Note: This property not available on the Record block. To assign a value to the Use Single Counter For Nomatch And Noinput property:

1. Select the Use Single Counter For Nomatch And Noinput row in the block's property table.
2. In the **Value** field, select true or false from the drop-down list.

Prompt Block

Use the Prompt block to play specific data to the caller. The Prompt block has no page exceptions. The Prompt block has the following properties:

Name Property

Find this property's details under [Common Properties](#).

Block Notes Property

Can be used for both callflow and workflow blocks to add comments.

Language Property

The language set by this property overrides any language set by the [Set Language](#) block, the Project preferences, or the incoming call parameters. The property takes effect only for the duration of this block, and the language setting reverts back to its previous state after the block is done. In the case of the Prompt block, this property affects the language of grammars of TTS output:

1. Click under Value to display a down arrow.
2. Click the down arrow and select English - United States (en-US) or the variable that contains the language.

Condition Property

Find this property's details under [Common Properties for Callflow Blocks](#).

Logging Details Property

Find this property's details under [Common Properties for Callflow Blocks](#).

Log Level Property

Find this property's details under [Common Properties for Callflow Blocks](#).

Enable Status Property

Find this property's details under [Common Properties for Callflow Blocks](#).

Clear Buffer Property

Use the Clear Buffer property for clearing the DTMF digits in the key-ahead buffer. If it is not set to true, the DTMF digits entered are carried forward to the next block. It is commonly used for applications the caller is familiar with. For example, the caller hears a welcome prompt but knows the next prompt will solicit the caller's input or menu selection. The caller may start inputting with dtmf while the welcome prompt plays and expect the input to carry forward. To assign a value to the Clear Buffer property:

1. Select the Clear Buffer row in the block's property table.
2. In the Value field, select true or false from the drop-down list.

Immediate Playback Property

Important! See Note in Timeout section below.

- When Immediate Playback is set to true, prompts are played immediately on the execution of the prompt without queuing them.
- When Immediate Playback is set to false (default), the interpreter goes to the transitioning state and queues the TTS Prompt until the interpreter waits for an input (such as the Menu, Input, Record, and Transfer blocks).

To assign a value to the Immediate Playback property:

1. Select the Immediate Playback row in the block's property table.
2. In the Value field, select true or false from the drop-down list. Selecting false will cause prompts only to be played when waiting for input. Set to false if you want prompts to be played consistent with the VXML default behavior as described below. Otherwise select true to have Composer force immediate playback.

VXML Behavior and Queueing of Prompts

A prompt gets played only when the platform is waiting for input. As described in Voice Extensible Markup Language (VoiceXML) Version 2.0, section 4.1.8, a VoiceXML interpreter is at all times in one of two states:

- waiting for input in an input item (such as <field>, <record>, or <transfer>), or
- transitioning between input items in response to an input (including spoken utterances, dtmf key presses, and input-related events such as a noinput or nomatch event) received while in the waiting state. While in the transitioning state no speech input is collected, accepted or interpreted...

The waiting and transitioning states are related to the phases of the Form Interpretation Algorithm as follows:

- the waiting state is eventually entered in the collect phase of an input item (at the point at which the interpreter waits for input), and
- the transitioning state encompasses the process and select phases, the collect phase for control items (such as <block>s), and the collect phase for input items up until the point at which the interpreter waits for input.

An important consequence of this model is that the VoiceXML application designer can rely on all executable content (such as the content of <filled> and <block> elements) being run to completion, because it is executed while in the transitioning state, which may not be interrupted by input. While in the transitioning state, various prompts are queued, either by the <prompt> element in executable content or by the <prompt> element in form items. In addition, audio may be queued by the fetchaudio attribute. The queued prompts and audio are played either

- when the interpreter reaches the waiting state, at which point the prompts are played and the interpreter listens for input that matches one of the active grammars, or
- when the interpreter begins fetching a resource (such as a document) for which fetchaudio was specified. In this case the prompts queued before the fetchaudio are played to completion, and then, if the resource actually needs to be fetched (i.e. it is not unexpired in the cache), the fetchaudio is played until the fetch completes. The interpreter remains in the transitioning state and no input is accepted during the fetch.

Interruptible Property

This property specifies whether the caller can interrupt the prompt before it has finished playing. To assign a value to the Interruptible property:

1. Select the Interruptible row in the block's property table.
2. In the Value field, select true,false,or DTMF (for DTMF barge-in mode support) from the drop-down list.

Note: For Prompts to be interruptible, there must be a an Input block ([Menu](#), [Input](#), etc.) in the execution path. If there are no such blocks further down in the execution path, the Interruptible property has no effect. If a Backend or Subdialog block has to be used after the Prompt block, insert an Input block before the Backend or Subdialog block for the prompt to be uninterruptible.

Prompts Property

Find this property's details under [Common Properties](#). Note: When Type is set to Value and Interpret-As is set to Audio, you can specify an HTTP or RTSP URL. When Type is set to Variable and Interpret-As is set to Audio, you can specify a variable that contains an HTTP or RTSP URL. Starting with 8.1.410.14, validation displays a warning message if a resource file does not exist.

Timeout Property

The Timeout property defines the length of the pause between when the voice application plays the last data in the list, and when it moves to the next block. To provide a timeout value:

1. Select the Timeout row in the block's property table.
2. In the Value field, type a timeout value, in seconds.

Note: Composer does not honor the Timeout setting if you keep the Immediate Playback default setting (=false); for example, where sequential prompts are used. In order for Composer to honor the timeout, you must set Immediate Playback to true.

Raise Event Block

Use the Raise Event block for Composer to throw custom events. You specify the event name and a message, which is selection of a dynamic variable. It is a terminating block (can end an application instead of an Exit block). Orchestration Server 8.1.2+ versions are required for Raise and Cancel Event blocks.

Also see [CustomEvents](#).

The Raise Event block has the following properties:

- The Raise Event block has no page exceptions.

Name Property

Find this property's details under [Common Properties for Callflow Blocks](#) or [Common Properties for Workflow Blocks](#).

Block Notes Property

Find this property's details under [Common Properties for Callflow Blocks](#) or [Common Properties for Workflow Blocks](#).

Delay Property

Enter the timeout or select a variable. Maps to <send delay>.

Unit Property

Select seconds or milliseconds for the delay. Maps to <send delay>.

Condition Property

Find this property's details under [Common Properties for Callflow Blocks](#) or [Common Properties for Workflow Blocks](#).

Logging Details Property

Find this property's details under [Common Properties for Callflow Blocks](#) or [Common Properties for Workflow Blocks](#).

Log Level Property

Find this property's details under [Common Properties for Callflow Blocks](#) or [Common Properties for Workflow Blocks](#).

Event Property

Select the variable or enter a value. Maps to <send event>.

Parameters Property

Add a list of key-values. Maps to <param>.

Enable Status

This property controls whether or not a block contributes code to the application. You may wish to use this property if there is a need to temporarily remove a block during debugging or, for other reasons during development, temporarily disable a block. This saves the effort of having to remove the block and then add it back later.

ORS Extensions Property

Starting with 8.1.4, Composer blocks used to build routing applications (with the exception of the Disconnect and EndParallel blocks) add a new [ORS Extensions](#) property.

Record Block

The Record block records voice input from the caller. Also see [Number of Allowed Attempts Exceeded Property](#). In case of user input blocks (Menu, Input, Record, Transfer), Composer adds a global variable of type "Block" to the variables list. You can conveniently use this variable for accessing the user input value. The Record block has the following properties: Record Block Exception Events The Record block has four exception events as described in [Exception Event Descriptions](#):

- error
- error.badfetch
- noinput]] (supported by default)
- error.com.genesyslab.composer.recordCapture.failure

Name Property

Please find this property's details under [Common Properties](#).

Block Notes Property

Can be used for both callflow and workflow blocks to add comments.

Exceptions Property

Find this property's details under [Common Properties](#).

Language Property

The language set by this property overrides any language set by the [Set Language](#) block, the Project preferences, or the incoming call parameters. The property takes effect only for the duration of this block, and the language setting reverts back to its previous state after the block is done. In the case of the Record block, this property affects the language of grammars of TTS output:

1. Click under Value to display a down arrow.
2. Click the down arrow and select English - United States (en-US) or the variable that contains the language.

Condition Property

Find this property's details under [Common Properties for Callflow Blocks](#).

Logging Details Property

Find this property's details under [Common Properties for Callflow Blocks](#).

Log Level Property

Find this property's details under [Common Properties for Callflow Blocks](#).

Enable Status Property

Find this property's details under [Common Properties for Callflow Blocks](#).

Output Result Property

You must use the Output Result property to assign the collected data to a user-defined **variable** for further processing. Note! This property is mandatory. You must select a variable for the output result even if you do not plan on using the variable. If this is not done, a validation error will be generated in the Problems view.

1. Select the Output Result row in the block's property table.
2. In the Value field, click the down arrow and select a variable.

For more information, see [Upgrading Projects/Diagrams](#).

Web Server Record File Name Property

User-defined variable (to be assigned) containing the file name of the recorded file located in the folder as specified in the Capture Location property.

1. Select the Web Server Record File Name row in the block's property table.
2. In the Value field, click the down arrow and select a variable.

Prompts Property

Find this property's details under [Common Properties](#). Note: When Type is set to Value and Interpret-As is set to Audio, you can specify an HTTP or RTSP URL. When Type is set to Variable and Interpret-As is set to Audio, you can specify a variable that contains an HTTP or RTSP URL. Starting with 8.1.410.14, validation displays a warning message if a resource file does not exist.

Timeout Property

The Timeout property defines the length of the pause between when the voice application plays the last data in the list, and when it moves to the next block. To provide a timeout value:

1. Select the Timeout row in the block's property table.
2. In the Value field, type a timeout value, in seconds.

Audio Format Property

This property specifies the audio format for the recording.

1. Select the Audio Format row in the block's property table.
2. In the Value field, select a format value from the drop-down list.

You can modify this value in order to specify enhanced format information such as the codec and the rate as in the following: `audio/x-wav;codec=g726;rate=<rate>`

Note: You can specify a bit rate as shown in the above example only for the g726 codec.

Beep Before Recording Property

The Beep Before Recording property indicates whether a beep sound will be played for the caller just before recording begins. When set to true, a beep sound will be played; when set to false, no beep will be played. To assign a value to the Beep Before Recording property:

1. Select the Beep Before Recording row in the block's property table.
2. In the Value field, select true or false from the drop-down list.

Dtmf Term Character Property

The Dtmf Term Character property defines any character that callers can input in order to indicate that they have finished entering data. For example, the prompt given to the caller may say "Enter

your account number, and then press the pound key." The pound key is the Dtmf-ending character. To provide a value for the Dtmf Term Character:

1. Select the Dtmf Term Character row in the block's property table.
2. In the Value field, type a value for a character to represent the end of the Dtmf string.

A typical value that is often used, as indicated above, is: # If several different DTMF tones could be used to indicate the end of data entry, type all values for the supported tones. No separation signs or characters are required. Examples:

- To use # or * then type the value as #*
- If any numeric key could be used for termination, type the value as 1234567890*#

Final Silence Property

The value supplied for the Final Silence property indicates the amount of silence (in seconds) that is allowed to elapse before recording will be stopped. The default value is 3 seconds. To provide a value for the Final Silence property:

1. Select the Final Silence row in the block's property table.
2. In the Value field, type a value for the allowable final silence before recording is stopped.

Max Duration Property

In the context of a Record block, the Max Duration property specifies the maximum recording duration. The default is 60 seconds.

To provide a value for the maximum recording duration:

1. Select the Max Duration row in the block's property table.
2. In the Value field, type a value for the maximum recording duration.

For more information on this property, refer to the Record VXML tag topic in [GVP 8.1 Voice XML Help](#).

Min Duration Property

In the context of a Record block, the Min Duration property specifies the minimum allowed recording duration. The default is 1 second. To provide a value for the minimum recording duration:

1. Select the Min Duration row in the block's property table.
2. In the Value field, type a value for the minimum recording duration.

Capture Filename Property

A value for the Capture Filename property is required when the Capture Filename Type property is set to the value `useSpecified`. To provide a filename for the captured recording:

1. Select the Capture Filename row in the block's property table.
2. In the Value field, you can:
 - Type a name for the recording file.
 - Click the down arrow and select a variable.

Capture Filename Prefix Property

A value for the Capture Filename Prefix property is required when the Capture Filename Type property is set to the value `usePrefix`. To provide a prefix for the captured recording filename:

1. Select the Capture Filename Prefix row in the block's property table.
2. In the Value field, you can:
 - Type a value for the recording file prefix.
 - Click the down arrow and select a variable.

Capture Filename Type Property

The Capture Filename Type property indicates the type of the filename for saving the recording. To assign a value to the Capture Filename Type property:

1. Select the Capture Filename Type row in the block's property table.
2. In the Value field, select one of the following from the drop-down list:
 - `auto-generate` a recording filename.
 - `usePrefix` to add the prefix value specified in the Capture Filename Prefix property to the default name that is generated for the recording.
 - `useSpecified` to use the value specified in the Capture Filename property as the filename for the recording. In this case, the file will be overwritten for each call.

Capture Location Property

The Capture Location property specifies the destination path on the Web Application server where the recording is to be saved.

If no location is specified, the recordings are saved in the working directory the web application server process. This location may change depending on the web server environment, and therefore, it is recommended that a fixed location is always specified in the Capture Location property. To specify a capture (recording) location:

1. Click the Capture Location row in the block's property table.
2. Type a file path where the recording is to be saved that is located on the web server hosting the application. If the web server is running on Linux, a UNIX-style path can be entered. Composer will not validate the path.

Security Property

When the Security property is set to true, data for this block is treated as private. GVP will consider the data associated with this block as sensitive and will suppress it in platform logs and metrics. To assign a value to the Security property:

1. Select the Security row in the block's property table.
2. In the Value field, select true or false from the drop-down list.

Use Last Reprompt Indefinitely Property

If you set the Use Last Reprompt Indefinitely property to true, the application uses your last reprompt as the prompt for all further retries. Therefore, the exception handlers that come out for nomatch and noinput are redundant--even if you set the default exceptions that come out as red dots on the left-side of the block. To assign a value to the Use Last Reprompt Indefinitely property:

1. Select the Use Last Reprompt Indefinitely row in the block's property table.
2. In the Value field, select true or false from the drop-down list.

Get Shadow Variables Property

Shadow variables (optional) provide a way to retrieve further information regarding the value of an input item. They can provide platform-related information about the interaction/input. For example, for speech recognition, this may be the confidence level the platform receives from the ASR engine about how closely the engine could match the user utterance to specified grammar. By setting this property to true, it will expose the block's shadow variable within the callflow. When enabled, the shadow variable will be included in the list of available variables. (For example, the Log block's Logging Details will show Record1\$.) A shadow variable is referenced as blockname\$.shadowVariable, where blockname is the value of the input item's name attribute, and shadowVariable is the name of a specific shadow variable, for example: Record1\$.duration. To assign a value to the Get Shadow Variables property:

1. Select the Get Shadow Variables row in the block's property table.
-

2. In the Value field, select true or false from the drop-down list.

Number of Retries Allowed Property

The Number Of Retries Allowed property determines how many opportunities the user will be provided to re-enter the value. If Use Last Prompt Indefinitely is set to true, this property has no effect; otherwise, the `error.com.genesyslab.composer.toomanynomatches` or `error.com.genesyslab.composer.toomanynoinputs` errors will be raised on reaching the maximum retry limit. To provide a value for the number of retries allowed:

1. Select the Number Of Retries Allowed row in the block's property table.
2. In the Value field, type a value for the number of retries that will be allowed.

Retry Prompts Property

Find this property's details under [Common Properties](#). Starting with 8.1.410.14, validation displays a warning message if a resource file does not exist.

Use Original Prompts Property

If you set the Use Original Prompts property to true, in the event of an error requiring a retry, the application first plays back the retry error prompt, and then plays back the original prompt for the block (as specified in the Prompts property). To assign a value to the Use Original Prompts property:

1. Select the Use Original Prompts row in the block's property table.
2. In the Value field, select true or false from the drop-down list.

Release ASR Engine Block

Use the Release ASR Engine block to control when the ASR engine(s) being used in the current session will be released. The Release ASR Engine block has the following properties: The Release ASR Engine block has no page exceptions.

Name Property

Find this property's details under [Common Properties](#).

Block Notes Property

Can be used for both callflow and workflow blocks to add comments.

Engine Name Property

The optional Engine Name property specifies the name(s) of the ASR engine(s) to release. If no engine is specified, all open ASR engines will be released. To specify an ASR engine to release:

1. Select the Engine Name row in the block's property table.
2. In the Value field, type the name of the ASR engine to release.

Condition Property

Find this property's details under [Common Properties for Callflow Blocks](#).

Logging Details Property

Find this property's details under [Common Properties for Callflow Blocks](#).

Log Level Property

Find this property's details under [Common Properties for Callflow Blocks](#).

Enable Status Property

Find this property's details under [Common Properties for Callflow Blocks](#).

Script Block

Script block is used to write custom ECMAScript code and VoiceXML code. The Script block has the following properties:

Name Property

Click under **Value** and enter the block name. Composer will use the name to identify the block in the diagram and as the state name in the code.

Block Notes Property

Find this property's details under [Common Properties](#).

Exceptions Property

Use to configure the exception nodes, with each port being hooked up to an event configured by you and selectable using Add Custom Event. Find this property's details under [Common Properties](#).

Condition Property

Find this property's details under [Common Properties](#).

Logging Details Property

Find this property's details under [Common Properties](#).

Log Level Property

Find this property's details under [Common Properties](#).

Enable Status Property

Find this property's details under [Common Properties](#).

Script Property

Click under Value to open [ExpressionBuilder](#) where you can enter the code.

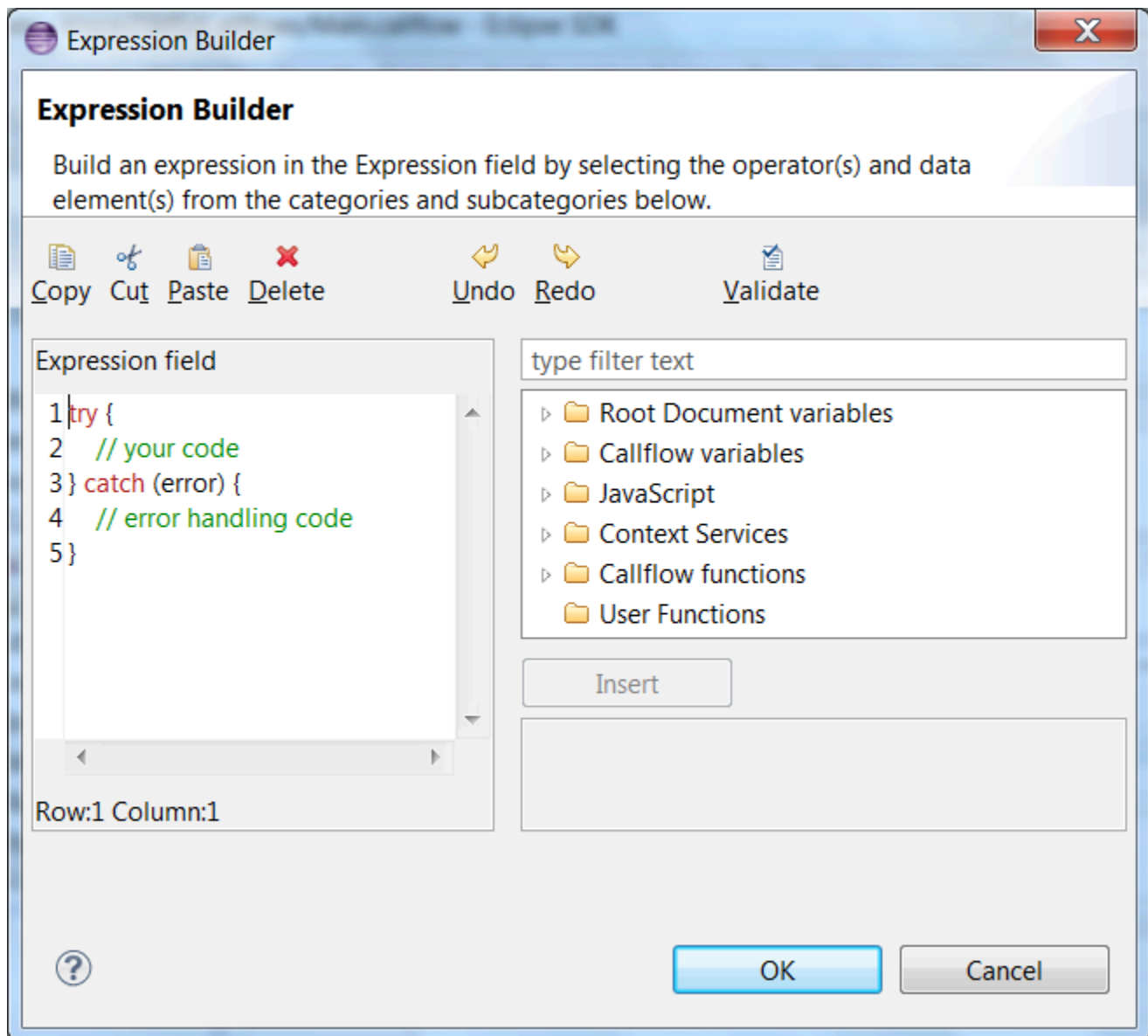

Set Language Block

The Set Language block changes the current active language from that set in the Entry block or a previous Set Language block. The language specified will be used for all subsequent prompts and grammars. This updates the **APP LANGUAGE** and **APP ASR LANGUAGE** global variables to the specified values. All audio and grammar resources will get picked from the specified language folder under the Resource folder of the Composer Project. Set Language is only applicable for audio and grammar files in Composer. Note: **Locales** that are not defined in Composer must be manually set in the diagram's **Assign block**. Example: **ASR LANGUAGE='te-IN'** Also see topic **Developing Multi-Lingual Applications**. The Set Language block has the following properties: The Set Language block has no page exceptions.

Name Property

Find this property's details under **Common Properties**.

Block Notes Property

Can be used for both callflow and workflow blocks to add comments.

Language

To set the active language for prompts and grammars:

1. Select the Language row in the block's property table.
2. In the Value field, select one of the following:
 - A language from the list of **locales** defined in the Project settings.
 - A variable that contains the active language.

Condition Property

Find this property's details under **Common Properties for Callflow Blocks**.

Logging Details Property

Find this property's details under [Common Properties for Callflow Blocks](#).

Log Level Property

Find this property's details under [Common Properties for Callflow Blocks](#).

Enable Status Property

Find this property's details under [Common Properties for Callflow Blocks](#).

SNMP Block

Use the SNMP block to send SNMP traps from the application. This uses the NGI 'dest' extension attribute of the <log> tag. All application-generated SNMP traps are mapped to a single TrapID as defined by the MCP. The EnableSNMP [voice application variable](#) is a flag to turn SNMP traps on or off from the SNMP block. The SNMP block has the following properties: The SNMP block has no page exceptions.

Name Property

Find this property's details under [Common Properties](#).

Block Notes Property

Can be used for both callflow and workflow blocks to add comments.

Condition Property

Find this property's details under [Common Properties for Callflow Blocks](#).

Logging Details Property

Find this property's details under [Common Properties for Callflow Blocks](#).

Log Level Property

Find this property's details under [Common Properties for Callflow Blocks](#).

Enable Status Property

Find this property's details under [Common Properties for Callflow Blocks](#).

Message Property

The Message property uses a dynamic variable as the message for the SNMP trap. To assign a variable as an SNMP trap:

1. Select the Message row in the block's property table.
2. In the Value field, enter the name of the variable containing the message for the SNMP trap.

The SNMP block will append the following information to the log message:

- session-id
- block name

The format will be : <session-id>::<block-name>::<log message>

Start FCR Block

Use the Start FCR (Start Full Call Recording) block to indicate the start of a recorded audio file. You specify the audio format of the recorded file, which is saved in the MCP folder specified in the [Capture Location](#) property. Once recording has started, all interactions will be recorded the End FCR block is reached or the call is terminated Notes:

- Starting and stopping at tapped points (as marked by the Start FCR block and either EndFCR block or the end of call) depends on the Prompt Queuing feature. For this reason, all Prompts between Start FCR and End FCR should have their [Immediate Playback property](#) set to true.
- The [enableFCR system variable](#) in the Entry block must be set to true in order to use this block.

The Start FCR block has the following properties: The Start FCR block has no page exceptions.

Name Property

Find this property's details under [Common Properties](#).

Block Notes Property

Can be used for both callflow and workflow blocks to add comments.

Audio Format Property

This property specifies the audio format for the recording.

1. Select the Audio Format row in the block's property table.
2. In the Value field, select an audio format value from the drop-down list.

The following audio formats are currently supported:

- audio/vox
- audio/basic
- audio/x-alaw-basic
- audio/x-g726-24
- audio/x-g726
- audio/x-adpcm

-
- audio/adpcm
 - audio/x-adpcm8
 - audio/x-g726-40
 - audio/L8
 - audio/L16
 - audio/x-wav
 - audio/wav
 - audio/x-wav;codec=ulaw
 - audio/wav;codec=ulaw
 - audio/x-wav;codec=alaw
 - audio/wav;codec=alaw
 - audio/x-vox
 - audio/x-wav;codec=pcm
 - audio/wav;codec=pcm
 - audio/x-wav;codec=pcm16
 - audio/wav;codec=pcm16
 - audio/x-wav;codec=g726
 - audio/wav;codec=g726
 - audio/x-gsm
 - audio/x-g729

You can modify this value in order to specify enhanced format information such as the codec and the rate as in the following: `audio/x-wav;codec=g729;rate=<rate>`

Capture Location Property

The Capture Location property specifies the location for the FCR files on MCP. The default value is `..\callrec`, but this value can be changed. To specify a capture (recording) location for the FCR files:

1. Click the Capture Location row in the block's property table.
2. Select the Value field and type a directory path, or keep the default `..\callrec` path.

Condition Property

Find this property's details under [Common Properties for Callflow Blocks](#).

Logging Details Property

Find this property's details under [Common Properties for Callflow Blocks](#).

Log Level Property

Find this property's details under [Common Properties for Callflow Blocks](#).

Enable Status Property

Find this property's details under [Common Properties for Callflow Blocks](#).

Subdialog Block

Use the Subdialog block for invoking VoiceXML subdialogs, which are a mechanism for reusing common dialogs and building libraries of reusable applications. Subcallflows called from a main callflow encapsulate VXML subdialogs and provide modularization for large VXML applications. An application can specify the URI of the subdialog to be invoked, pass parameters, and receive output results. Parameters of type In, Out and InOut are supported. You have the option to select how the parameters are to be passed to the invoked subdialog. In the case of Dynamic pages (like JSPs) you can specify the method for sending Get / Post and Use Namelist to indicate the parameters are to be passed as Query String values.

These two choices do not apply in the case of static subdialogs (such as those generated by Composer Voice). The Subdialog block also has the ability to invoke subcallflows created by Composer Voice. In this case, auto-synchronization of input and output parameters is provided. A developer will be able to select a subcallflow to invoke from the current Composer Project.

Also see [Using Composer Shared Subroutines](#).

Important

Starting with Composer 8.1.3 versions, the callflow diagram Subdialog block and the workflow diagram Subroutine block use absolute paths with the Project name to refer to the location of the selected resource in the Workspace, e.g., `workspace:///WFM/Workflows/subroutine.workflow`. Renaming or copying Projects requires a manual update to change the Project name in the Subroutine and Subdialog blocks.

The Subdialog block has the following properties:

The Subdialog block has no page exceptions.

Name Property

Please find this property's details under [Common Properties](#).

Block Notes Property

Can be used for both callflow and workflow blocks to add comments.

Exceptions Property

Find this property's details under [Common Properties](#).

Method Property

This property Indicates the method for invoking the subdialog:

- **get**--Invoked using HTTP Get
- **post**--Invoked using HTTP Post. This option is valid only when the parameters are passed as a namelist (Use Namelist property is set to true). This is generally used when a large amount of data needs to be sent as an input value for a subdialog.

To select a value for the Method property:

1. Select the Method row in the block's property table.
2. In the Value field, select get or post from the drop-down list.

Type Property

The Type property sets the type of the invoked subdialog. There are two options:

- **URL**--The invoked subdialog can be found at the location specified in the Uri property.
- **ProjectFile**--The invoked subdialog is a subcallflow in the Composer Project.

To select a value for the Type property:

1. Select the Type row in the block's property table.
2. In the Value field, select URL or ProjectFile from the drop-down list.

Uri Property

The Uri property specifies the destination (URL or Composer Project) depending on the value of the Type property. To set a URL destination for the Uri property (Type property is set to URL):

1. Select the Uri row in the block's property table.
2. In the Value field, type a valid URL, or select a **variable** from the drop-down list.

To set a Composer Project destination for the Uri property (Type property is set to ProjectFile):

1. Click the Uri row in the block's property table.

2. Click the  button to open the Uri dialog box.
3. Select a callflow in the list.
4. Click OK to close the dialog box.

Composer automatically synchronizes the Input and return variables of the selected sub-callflow with the main callflow by adding them as Input/Output parameters in the corresponding Subdialog Block. Open the Parameters Property of the Subdialog Block to assign the desired value. Note: For a selected studio diagram file, right-click the block's context menu and select the Open Sub Callflow Diagram option to open the chosen Subcallflow diagram file in the Workbench window.

Condition Property

Find this property's details under [Common Properties for Callflow Blocks](#).

Logging Details Property

Find this property's details under [Common Properties for Callflow Blocks](#).

Log Level Property

Find this property's details under [Common Properties for Callflow Blocks](#).

Enable Status Property

Find this property's details under [Common Properties for Callflow Blocks](#).

Security Property

When the Security property is set to true, data for this block is treated as private (for example, credit card account numbers, Social Security numbers, date of birth information, and so on). GVP will consider the data associated with this block as sensitive and will suppress it in platform logs and metrics. To assign a value to the Security property:

1. Select the Security row in the block's property table.
2. In the Value field, select true or false from the drop-down list.

Parameters Property

Use the Parameters property to specify parameters to pass to the invoked subdialog. To specify parameters:

1. Click the Parameters row in the block's property table.
2. Click the  button to open the Parameter Setting dialog box.

If the Type Property is ProjectFile, all the Input/Output parameters are automatically synchronized between the sub-callflow and the main callflow. The Input/Output parameters are automatically added based on the sub-callflow Input/Output parameters. In this case, there are no Add and Delete buttons in the Parameter Setting dialog box as described below. You must fill in the Variables column.

Add Button

Use the Add button to enter parameter details.

1. Click Add to add an entry to SubDialog Parameters.
2. In the Parameter Name field, accept the default name or change it.
3. From the Parameter Type drop-down list, select In, Out, or InOut:

In	Input parameters are variables submitted to the subdialog.
Out	Output parameters are variables that the subdialog returns and will be reassigned back to the current callflow.
InOut	InOut parameters are parameters that act as both input and output.

1. In the Expression drop-down list, select from among the **variables** shown, type your own expression, or click the  button to use **Expression Builder**.
2. In the Definition field, type a description for this parameter.
3. Click Add again to enter another parameter, or click OK to finish.

Delete Button

To delete a parameter:

1. Select an entry from the list.
2. Click Delete.

Use Namelist

Indicates whether the subdialog parameters need to be submitted as a namelist (if set to true) to the called subdialog. To select a value for the Use Namelist property:

1. Select the Use Namelist row in the block's property table.
2. In the Value field, select true or false from the drop-down list.

Fetch Audio Property

Enter the fetchaudio file to play when executing a long-running task, such as a server side web query. By default, Next Generation Interpreter (NGI) supplies a built-in fetchaudio file. For information on GVP support of fetchaudio, see:

- Fetching Properties in [GVP Voice XML Help](#).
- The VoiceXML Properties section of the [GVP 8.1 Legacy Genesys VoiceXML 2.1 Reference Manual](#).
- The Prompt block, [VXML Behavior and Queueing of Prompts](#).

Fetch Audio Delay Property

Enter the length of time to wait at the start of a fetch delay before playing fetchaudio. For more information, see Fetching Properties in [GVP Voice XML Help](#)

Fetch Audio Minimum Property

Enter the minimum length of time to play fetchaudio, once started, even if the fetch result arrives in the meantime. For more information, see Fetching Properties in [GVP Voice XML Help](#)

Fetch Hint Property

Select prefetch or safe to define when XML data files can be fetched. Selecting safe indicates to only load the XML data file when needed. For more information, see Fetching Properties in [GVP Voice XML Help](#).

Fetch Timeout Property

Enter the timeout for fetches. This is not supported when using Nuance (MRCP). An error.badfetch is

thrown when a fetch duration exceeds fetchtimeout. For more information, see Fetching Properties in [GVP Voice XML Help](#).

Max Age Property

Enter the maximum acceptable age, in seconds, of cached audio resources. For more information, see Fetching Properties in [GVP Voice XML Help](#).

Max Stale Property

Enter the maximum staleness, in seconds, of expired cached audio resources. For more information, see Fetching Properties in [GVP Voice XML Help](#).

Transfer Block

Use the Transfer block to transfer the call to another destination. By default, blind transfer is enabled, and it has no outports. However, if you enable bridging, the block will have one or more outports. In case of user input blocks (Menu, Input, Record, Transfer), Composer adds a global variable of type "Block" to the variables list. You can conveniently use this variable for accessing the user input value.

Use the Transfer block for non-CTI VXML transfers and Route Request block for CTI transfers.

The Transfer block has the following properties:

Transfer Block Exception Events

The Transfer block has the following exception events as described in [Exception Event Descriptions](#):

- connection.disconnect.hangup
- connection.disconnect.transfer (supported by default)
- error (supported by default)
- error.connection.baddestination (supported by default)
- error.connection.noauthorization
- error.connection.noresource
- error.connection.noroute
- error.connection
- error.unsupported.transfer.blind
- error.unsupported.transfer.consultation
- error.unsupported.uri

Name Property

Please find this property's details under [Common Properties](#).

Block Notes Property

Can be used for both callflow and workflow blocks to add comments.

Exceptions Property

Find this property's details under [Common Properties](#).

Language Property

The language set by this property overrides any language set by the [Set Language](#) block, the Project preferences, or the incoming call parameters. The property takes effect only for the duration of this block, and the language setting reverts back to its previous state after the block is done. In the case of the Transfer block, this property affects the language of grammars used for ASR input:

1. Click under Value to display a down arrow.
2. Click the down arrow and select English - United States (en-US) or the variable that contains the language.

Condition Property

Find this property's details under [Common Properties for Callflow Blocks](#).

Logging Details Property

Find this property's details under [Common Properties for Callflow Blocks](#).

Log Level Property

Find this property's details under [Common Properties for Callflow Blocks](#).

Enable Status Property

Find this property's details under [Common Properties for Callflow Blocks](#).

Output Result Property

You must use the Output Result property to assign the collected data to a user-defined [variable](#) for further processing. Note: This property is mandatory. You must select a variable for the output result even if you do not plan on using the variable. If this is not done, a validation error will be generated in

the Problems view.

1. Select the Output Result row in the block's property table.
2. In the Value field, click the down arrow and select a variable.

For more information, see [Upgrading Projects/Diagrams](#).

Transfer Audio Property

The optional Transfer Audio property plays a prompt to the end user while the number is being dialed out. You provide the URI of the audio source to play while the transfer attempt is in progress (before the other end answers). If the callee answers, the interpreter terminates playback of the recorded audio immediately. If the end of the audio file is reached and the callee has not yet answered, the interpreter plays the audio tones from the far end of the call (ringing, busy). If the resource cannot be fetched, the error is ignored and the transfer continues. To provide a Transfer Audio value:

1. Select the **Transfer Audio** row in the block's property table.
2. In the **Value** field, type a Transfer Audio value URI (HTTP or RTSP) specifying the location of the audio file to play.

Aai Property

Use the optional Application-to-Application Information (the Aai property) for the data that is to be transferred from the current application to another application. Use this option to transfer the call to a number that initiates another voice application. To assign a value to the Aai property:

1. Select the **Aai** row in the block's property table.
2. In the **Value** field, select a value from the drop-down list.

Values are the Voice Application Variables described under the [Variables Property](#).

Authorization Code Property

GVP supports dialing of an authorization code as part of an outbound call on a two-leg transfer. Use free form text to specify the authorization code in the application.

Connect Timeout Property

Use the Connect Timeout property for the connection timeout value. The default is 15 seconds. For information on what happens if a timeout occurs, select Help > Contents and see the [GVP 8.1 Voice XML 2.1 Reference Help](#)¹. Specifically see Standard VoiceXML > Variables > Transfer, attribute

connecttimeout. To provide a timeout value:

1. Select the **Connect Timeout** row in the block's property table.
2. In the **Value** field, type a timeout value, in seconds.

Connect When Property

This property controls when the call is connected to the end point. To assign a value:

1. Select the **Connect When** row in the block's property table.
2. In the **Value** field, select answered or immediate from the drop-down list.

Destination Property

The Destination property contains the destination phone number. The destination number can be one of the following:

- A Virtual Route point number on which the IRD Strategy is loaded
- Extension number of an Agent
- External number

The value must be specified in one of the formats below:

- sip:[user@]host[:port]
- tel:phonenumber e.g., tel:+358-555-1234567

For information on this property, select Help > Contents and see the [GVP 8.1 Voice XML 2.1 Reference Help](#). Specifically see Standard VoiceXML > Variables > Transfer, attribute dest. To assign a value to the Destination property:

1. Select the **Destination** row in the block's property table.
2. In the **Value** field, select a value from the drop-down list.

Values are the Voice Application Variables described under the [Variables Property](#).

Max Call Duration Property

Use the Max Call Duration property for the maximum call duration. The default is 3600 seconds. (This is not supported for Consultation Transfer Type.) Note: If this is set to 0 (zero), an infinite value is supplied, and there is no upper limit to the call duration. To provide a value for the maximum call duration:

1. Select the **Max Call Duration** row in the block's property table.
2. In the **Value** field, type a value for the maximum call duration.

Transfer Type Property

Specifies the type of the Transfer, which determines whether or not the caller's session with the VoiceXML interpreter resumes after the call initiated by the transfer ends. Note: Composer also supports AT&T blind transfers with the following options: Out of Band Courtesy, Out of Band Consult, and Out of Band Conference. For more information on these options, start with the GVP 8.1 Voice XML Reference Help (Help > Contents). Search for ATTOOBCOURTESY, ATTOOBCONSULT, and ATTOOBCONFERENCE (Transfer topic). Also see the *Genesys Voice Platform 8.1 Deployment Guide*. To assign a value to the Transfer Type property:

1. Select the **Transfer Type** row in the block's property table.
2. In the **Value** field, select one of the following from the drop-down list:

Blind is the default setting. The platform redirects the caller to the agent without remaining in the connection, and it does not monitor the outcome. Once the caller is handed off to the network, the caller's session with the VoiceXML application cannot be resumed. The VoiceXML interpreter throws a `connection.disconnect.transfer` immediately, regardless of whether the transfer was successful or not.

Bridge causes the platform add the agent to the connection. Document interpretation suspends until the transferred call terminates. The platform remains in the connection for the duration of the transferred call; listening during transfer is controlled by any included `<grammar>`s. If the caller disconnects by going onhook or if the network disconnects the caller, the platform throws a `connection.disconnect.hangup` event. If the agent disconnects, then transfer outcome is set to `near_end_disconnect` and the original caller resumes her session with the VoiceXML application.

Consultation causes the consultation transfer to be similar to a blind transfer except that the outcome of the transfer call setup is known and the caller is not dropped as a result of an unsuccessful transfer attempt. When performing a consultation transfer, the platform monitors the progress of the transfer until the connection is established between caller and agent. If the connection cannot be established (e.g. no answer, line busy, etc.), the session remains active and returns control to the application. As in the case of a blind transfer, if the connection is established, the interpreter disconnects from the session, `connection.disconnect.transfer` is thrown, and document interpretation continues normally. Any connection between the caller and the agent remains in place regardless of document execution. **Note:** The selected transfer type will work only if the platform is provisioned to support that type of transfer.

Variables Property

Important

The Transfer block Variables property is for Transfer signaling (`gvp:signalvar`)

variable configuration and not for user data. To send user data in the transfer <gvp:transfer> request use the Route Request block.

This is the list of variables that can be optionally sent by the application as part of the Transfer Request to the far end. It corresponds to the signalvars extension attribute of the NGI VXML Interpreter. Check the [Genesys Voice VXML 2.1 Reference Manual](#) for more details.

All variables that are selected (checked) will be sent as part of the signalvars . The name of the variable will be used as the key name and the actual value will be the corresponding value. Refer to the [GVP Documentation](#) for details on the signalvars attribute. The variable name must match the name of the key that will be sent as signalvars.

To declare session variables for the application or subcallflow:

1. Click the **Variables** row in the block's property table.
2. Click the ... button to open a **Variables** dialog box.
3. Click **Add** and enter key-value pairs.
4. Click Value is an integer if application.
5. You can also click **Remove** or **Removal All**.

Important

The steps below are valid up to 8.1.430.01. After that, the **Variables** dialog box supports the key-value pairs.

To declare session variables for the application or subcallflow:

1. Click the **Variables** row in the block's property table.
2. Click the ... button to open a Variables dialog box,
3. Select individual variables.
4. You can also click **Select All** or **Deselect All**.
5. Click **OK**.

Method Property

The Method property specifies the type of SIP transfer method that the Media Control Platform (MCP) uses. To assign a value to the Method property:

1. Select the **Method** row in the block's property table.
2. In the **Value** field, select one of the following from the drop-down list (descriptions below):

Bridge

A Bridge method indicates that the Media Control Platform (MCP) bridges the media path.

1. The platform sends an INVITE request to the callee, and a dialog is established between the callee and the platform.
2. The transfer fails if a non-2xx final response is received for the INVITE request.

This is a two-leg transfer (in other words, it occupies two channels on the platform). The platform stays in the signaling path and is responsible for bridging the two call legs.

Hkf (Hookflash)

A Hookflash method indicates a transfer using DTMF digits (RFC 2833).

1. The Media Control Platform (MCP) sends DTMF digits on the media channel. The platform leaves it to the media gateway or switch to perform the transfer on the network.
2. Configurable options enable you to specify whether the call will be disconnected by the platform or by the remote end. Otherwise, the call is disconnected after a configured timeout.

This is a one-leg transfer (in other words, it occupies only one channel on the platform).

Refer

A Refer method indicates that the transfer is based on a SIP REFER message (RFC 3515).

1. The platform sends a REFER request to the caller, with the callee (as specified in the VoiceXML application) in the Refer-To: header.
2. The transfer fails if a non-2xx final response is received for the REFER.

This is a one-leg transfer (in other words, it occupies only one channel on the platform).

Referjoin

A Referjoin method indicates a consultative REFER transfer (RFC 3891).

1. The platform sends an INVITE request to the callee, and a dialog is established between the callee and the platform.
2. The platform also sends a REFER request to the caller, with the callee's information in the Replaces header.
3. The platform considers the transfer to be successful if it receives a BYE from the caller after a 2xx response for the REFER.
4. The transfer fails if a non-2xx final response is received for the INVITE request or for the REFER request.

This is a two-leg, or join-style, transfer (in other words, it occupies two channels on the platform).

Mediaredirect

A Mediaredirect method indicates a media redirection transfer. The Media Control Platform (MCP) uses SIP to handle call control between the caller and the callee, and the RTP media channel is connected directly between the caller and callee.

1. The platform sends an INVITE request to the callee without SDP.
2. If the transfer is proceeding, the callee responds with a 200 OK that includes an SDP offer.
3. The platform forwards the SDP offer in a re-INVITE request to the caller.
4. The caller responds with a 200 OK that includes the SDP answer.
5. The platform forwards the SDP answer to the callee in an ACK response.
6. The transfer fails if a non-2xx final response is received for the initial INVITE request.

This is a two-leg transfer (in other words, it occupies two channels on the platform). attcourtesy attconsult attconference attoobcourtesy attoobconsult attoobconference For information on these methods, consult the section on how the Media Control Platform works in the *Genesys Voice Platform 8.1 Deployment Guide*.

Disconnect on Answering Machine Property

This property indicates whether or not the FAX / Answering machine has to be detected. To assign a value:

1. Select the **Disconnect on Answering Machine** row in the block's property table.
2. In the **Value** field, select true or false from the drop-down list.

Do CPA Analysis Property

This property indicates whether or not the platform is enabled to detect who/what answered the call. To assign a value:

1. Select the **Do CPA Analysis** row in the block's property table.
2. In the **Value** field, select true or false from the drop-down list.

Get Shadow Variables Property

Shadow variables (optional) provide a way to retrieve further information regarding the value of an input item. They can provide platform-related information about the interaction/input. For example, for speech recognition, this may be the confidence level the platform receives from the ASR engine about how closely the engine could match the user utterance to specified grammar. By setting this property to true, it will expose the block's shadow variable within the callflow. When enabled, the

shadow variable will be included in the list of available variables. (For example, the Log block's Logging Details will show Transfer1\$.) A shadow variable is referenced as blockname\$.shadowVariable, where blockname is the value of the input item's name attribute, and shadowVariable is the name of a specific shadow variable, for example: Transfer1\$.duration. To assign a value:

1. Select the **Get Shadow Variables** row in the block's property table.
2. In the **Value** field, select true or false from the drop-down list.

Transfer Results Property

There are several types of transfer results supported for applications. When you select a transfer result, a corresponding output node is added to the block to allow specific actions to be taken for that condition. Please note that a default output is always present. The default path is executed if none of the selected transfer results are set. The available transfer results are:

- far_end_disconnect (selected by default)
- noanswer (selected by default)
- busy (selected by default)
- near_end_disconnect

Note: Consultation Transfer supports only noanswer, busy, and near_end_disconnect transfer results. To select transfer results:

1. Click the **Transfer Results** row in the block's property table.
2. Click the ... button to open the **Transfer Results** dialog box.
3. Select items from the list of available CPA results, or click Select all or Deselect all as needed.

Input Grammar Dtmf Property

Use the Input Grammar **Dtmf** (Dual Tone Multi-Frequency) property to specify the DTMF **Grammar** for the Transfer block, which accepts DTMF signals or speech input from callers. The DTMF Grammar is processed and handled by GVP. In the case of external grammars, this specifies the actual path of the grammar file / resource for DTMF Grammars. This is only valid when the Grammar Type is externalGrammar and Input Mode is dtmf or hybrid. To assign a value to the Input Grammar Dtmf property:

1. Select the Input Grammar Dtmf row in the block's property table.
2. In the Value field, select a value from the drop-down list.

Values are the Voice Application Variables described under the Variables Property. Section 2.3.7.2.1, of the Voice Extensible Markup Language (VoiceXML) Version 2.0 specification (<http://www.w3.org/TR/voicexml20/#dml2.3.7.2.1>), contains the following information on listening for user input during a transfer (interrupting a transfer): Platforms may optionally support listening for caller commands to

terminate the transfer by specifying one or more grammars inside the <transfer> element. The <transfer> element is modal in that no grammar defined outside its scope is active. The platform will monitor during playing of prompts and during the entire length of the transfer connecting and talking phases:

- DTMF input from the caller matching an included DTMF grammar
- an utterance from the caller matching an included speech grammar

A successful match will terminate the transfer (the connection to the callee); document interpretation continues normally. An unsuccessful match is ignored. If no grammars are specified, the platform will not listen to input from the caller. The platform does not monitor in-band signals or voice input from the callee.

Input Grammar Voice Property

Use the Input Grammar Voice property to specify the Voice Grammar for the Input block, which accepts DTMF or speech input from callers. If you are writing hybrid applications that allow both DTMF and Speech input, specify both the DTMF and Voice grammars. The Voice grammar is sent to the ASR Engine for processing, whereas the DTMF grammar is processed by GVP. As a result, you need two separate grammars for Voice and DTMF in the case of hybrid applications that allow both Voice and DTMF inputs. In the case of external grammars, this specifies the actual path of the grammar file / resource for ASR Grammars.. This is only valid when Grammar Type is externalGrammar and Input Mode is voice or hybrid. To assign a value to the Input Grammar Voice property:

1. Select the **Input Grammar Voice** row in the block's property table.
2. In the **Value** field, select a value from the drop-down list.

Values are the Voice Application Variables described under the Variables Property.

Input Mode Property

To assign a value to the Input Mode property:

1. Select the **Input Mode** row in the block's property table.
2. In the **Value** field, select one of the following from the drop-down list (descriptions below):

DTMF

The DTMF format indicates the menu option mode of input will be via the telephone keypad.

Voice

The Voice format indicates the menu option mode of input will be a voice phrase.

Hybrid

The Hybrid menu mode will handle both DTMF and Voice inputs, that is via telephone keypad and voice phrase.

VXML Form Block

Use this block to embed VXML code directly into a callflow diagram.

Name Property

Find this property's details under [Common Properties](#).

Block Notes Property

Can be used for both callflow and workflow blocks to add comments.

Exceptions Property



Find this property's details under [Common Properties](#).

Enable Status Property

Find this property's details under [Common Properties](#).



Body Property

This property contains all the executable content of the `<form>` element before directing to a block or external application.

1. Click opposite **Body** under **Value**. This brings up the  button.
2. Click the  button to bring up the Configure Body dialog box.
3. Enter the executable content of the `<form>` element. .
4. When through, click **OK**. Note: The editor does not validate against the VXML schema.

Gotostatements Property

This property allows the you to configure the output nodes of the blocks. An output port is created for every GOTOStatement item with target enabled.

1. Click opposite **Gotostatements** under **Value**. This brings up the  button.
2. Click the  button to bring up the Gotostatements dialog box.
3. Click **Add**.
4. When Target is disabled, select **ProjectFile** or **URL** to indicate the destination application type. When ProjectFile is selected, you can click the button to enter the URI. When URL is selected, you can click the URI button and specify a literal or a variable.
5. When URL is selected, you can also click the Parameters button to select a system variable.
6. For each goto statement, specify at least one event, condition, or target (you are not required to complete all three fields). An output port is created for every goto statement.
 - **Name**--Composer uses the name of the goto statement to label the outport.
 - **Event**--Use to select the event that will trigger the goto statement.
 - **Condition**--The guard condition for this goto statement. The goto statement is selected only if the condition evaluates to true.
 - **Target**--If a target is set, an outport for that goto statement will appear and you can connect it to other blocks. If a target is not set, an outport for that goto statement does not appear; in this case, you can add some VXML code to handle the event.

Voice Database Blocks

The Database palette provides blocks that enable VXML applications to use databases.

Types of Blocks

There are three Database blocks:

- **DB Data Block** for connecting to a database and retrieving/manipulating information from/in a database.
- **DB Prompt Block** for speaking out prompts generated using TTS based on the data returned by an associated DB Data block.
- **DB Input Block** for accepting a DB Data block as its data source and acting as an input field that accepts input based on a grammar created from the results returned from the database.

Also see:

- [Working with Database Blocks](#) for an overview of database support in Composer including a high level description of how it works as well as level of support for various databases.
- [Supported SQL Datatypes](#).

Video Tutorial

Below is a video tutorial on using the Database Blocks.

Important Note: While the interface for Composer in this video is from release 8.0.1, the steps are the basically the same for subsequent releases.

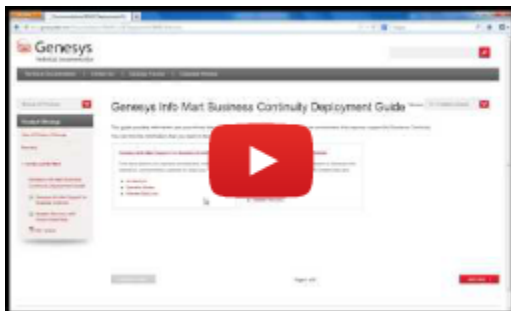

Using the Database Blocks

Using these blocks, VXML applications can connect to databases and query data from them. It also provides blocks that consume this retrieved data and perform high level operations on it like speaking out the returned data or accepting user input against a grammar generated from the returned data.

DB Data Block

The DB Data block is used for both routing and voice applications. See the [DB Data Block](#) topic in the Common Blocks book. Also see [Working with Database Blocks](#).

Database Input Block

The DB Input block accepts a [DB Data](#) block as its data source and acts as an input field that accepts input based on a grammar created from the results returned from the database.

It accepts DTMF or speech input. This block differs from the [Menu block](#) in that it enables taking input that might not belong to a simple choice list (as for the Menu block). The DB Input block can be used to collect numerical data; for example, phone numbers, account numbers, amounts, or speech data, such as a Stock name. It uses speech or DTMF grammars to define the allowable input values for the user responses. Built-in system grammars are available for data, such as dates and amount.

The user input result will be stored in a block name variable in the VXML application.

Note: If the DB Input block uses a [DB Data](#) block as its data source, it uses only the first column from returned results to generate the grammar.

The DB Input block can also use a variable as a data source instead of a DB Data block. In this case, grammar for the input is generated based on data in the array. The variable should represent a JSON array similar to the sample below:

```
myVariable="[["Google"],["Apple"],["Motorola"],["Samsung"],["Nokia"]]"
```

The DB Input block has the following properties:

DB Input Block Exception Events

The DB Input block has four exception events as described in [Exception_Event_Descriptions](#):

- error
- error.noresource
- noinput
- nomatch

Name Property

Please find this property's details under [Common Properties](#).

Block Notes Property

Can be used for both callflow and workflow blocks to add comments.

Data Source Property

The Data Source property allows you to select the DB Data block that contains a previously-defined database query. This is used when DBDataBlock is selected as the Data Source Type property value. The results of this database query will be used to create the input field.

To select the data source (a DB Data block):

1. Select the **Data Source** row in the block's property table.
2. In the **Value** field, select the appropriate DB Data block from the drop-down list.

Data Source Type Property

The Data Source Type property allows you to select whether your data source is the contents of a DB Data block or a variable.

To select the data source type:

1. Select the **Data Source Type** row in the block's property table.
2. In the **Value** field, select DBDataBlock or Variable from the drop-down list.

Data Source Variables Property

The Data Source Variables property allows you to select the contents of a **variable** as your data source. This is used when Variable is selected as the Data Source Type property value.

To select the variable that serves as your data source:

1. Select the Data Source Variable row in the block's property table.
2. In the Value field, select one of the available **variables** from the drop-down list. This can also be a custom variable you assigned in the Entry block.

Exceptions Property

Find this property's details under [Common Properties](#).

Language Property

The language set by this property overrides any language set by the [Set Language](#) block, the Project preferences, or the incoming call parameters. The property takes effect only for the duration of this

block, and the language setting reverts back to its previous state after the block is done. In the case of the DB Input block, this property affects the language of grammars of TTS output:

1. Click under Value to display a down arrow.
2. Click the down arrow and select English - United States (en-US) or the variable that contains the language.

Clear Buffer Property

Use the Clear Buffer property for clearing the DTMF digits in the key-ahead buffer. If it is not set to true, the DTMF digits entered are carried forward to the next block. It is commonly used for applications that the caller is familiar with. For example, the caller hears a welcome prompt but knows the next prompt will solicit the caller's input or menu selection. The caller may start inputting with DTMF while the welcome prompt plays and expect the input to carry forward.

To assign a value to the Clear Buffer property:

1. Select the **Clear Buffer** row in the block's property table.
2. In the **Value** field, select true or false from the drop-down list.

Interruptible Property

This property specifies whether the caller can interrupt the prompt before it has finished playing.

To assign a value to the Interruptible property:

1. Select the **Interruptible** row in the block's property table.
2. In the Value field, select true,false,or DTMF (for DTMF barge-in mode support) from the drop-down list.

Prompts Property

Find this property's details under [Common Properties](#).

Note: When Type is set to Value and Interpret-As is set to Audio, you can specify an HTTP or RTSP URL. When Type is set to Variable and Interpret-As is set to Audio, you can specify a variable that contains an HTTP or RTSP URL.

Timeout Property

The Timeout property defines the length of the pause between when the voice application plays the last data in the list, and when it moves to the next block.

To provide a timeout value:

1. Select the **Timeout** row in the block's property table.
2. In the **Value** field, type a timeout value, in seconds.

Security Property

When the Security property is set to true, data for this block is treated as private. GVP will consider the data associated with this block as sensitive and will suppress it in platform logs and metrics.

To assign a value to the Security property:

1. Select the Security row in the block's property table.
2. In the Value field, select true or false from the drop-down list.

Output Result Property

You must use the Output Result property to assign the collected data to a user-defined **variable** for further processing.

- **Note!** This property is mandatory. You must select a variable for the output result even if you do not plan on using the variable. If this is not done, a validation error will be generated in the Problems view.

1. Select the Output Result row in the block's property table.
2. In the Value field, click the down arrow and select a variable.

For more information, see [Upgrading Projects/Diagrams](#).

Get Shadow Variables Property

Shadow variables provide a way to retrieve further information regarding the value of an input item.

By setting this property to true, it will expose the block's shadow variable within the callflow. When enabled, the shadow variable will be included in the list of available variables. (For example, the Log block's Logging Details will show DBInput1\$.)

A shadow variable is referenced as `blockname$.shadowVariable`, where `blockname` is the value of the input item's name attribute, and `shadowVariable` is the name of a specific shadow variable, for example: `DBInput1$.duration`.

To assign a value to the Get Shadow Variables property:

1. Select the **Get Shadow Variables** row in the block's property table.
-

2. In the Value field, select true or false from the drop-down list.

Number of Retries Allowed Property

The Number Of Retries Allowed property determines how many opportunities the user will be provided to re-enter the value. If Use Last Prompt Indefinitely is set to true, this property has no effect; otherwise, the `error.com.genesyslab.composer.toomanynomatches` or `error.com.genesyslab.composer.toomanynoinputs` errors will be raised on reaching the maximum retry limit.

To provide a value for the number of retries allowed:

1. Select the Number Of Retries Allowed row in the block's property table.
2. In the Value field, type a value for the number of retries that will be allowed.

Retry Prompts Property

Find this property's details under [Common Properties](#).

Use Last Reprompt Indefinitely Property

If you set the Use Last Reprompt Indefinitely property to true, the application uses your last reprompt as the prompt for all further retries. In this case the NoMatch and NoInput exception handlers will never get executed, as the retry loop keeps executing forever.

To assign a value to the Use Last Reprompt Indefinitely property:

1. Select the **Use Last Reprompt** Indefinitely row in the block's property table.
2. In the Value field, select true or false from the drop-down list.

Use Original Prompts Property

If you set the Use Original Prompts property to true, in the event of an error requiring a retry, the application first plays back the retry error prompt, and then plays back the original prompt for the block (as specified in the Prompts property).

To assign a value to the Use Original Prompts property:

1. Select the **Use Original Prompts** row in the block's property table.
2. In the Value field, select **true** or **false** from the drop-down list.

Use Single Counter for Nomatch And Noinput Property

If you set the Use Single Counter For Nomatch And Noinput property to true, the application maintains a single combined counter for the nomatch and noinput errors. For example, if the block has three nomatch retry messages and three noinput retry messages, the user gets three retry attempts. If you do not select this option, the application generates a total of six retries; and the user gets up to six retry attempts while not exceeding three of each type - noinput or nomatch.

Note: This property not available on the Record block.

To assign a value to the Use Single Counter For Nomatch And Noinput property:

1. Select the Use Single Counter For Nomatch And Noinput row in the block's property table.
2. In the Value field, select true or false from the drop-down list.

Condition Property

Find this property's details under [CommonPropertiesforCallflowBlocks](#).

Logging Details Property

Find this property's details under [CommonPropertiesforCallflowBlocks](#).

Log Level Property

Find this property's details under [CommonPropertiesforCallflowBlocks](#).

Enable Status Property

Find this property's details under [CommonPropertiesforCallflowBlocks](#).

DB Prompt Block

The DB Prompt block speaks out prompts generated using TTS based on the data returned by an associated **DB Data** block. The DB Prompt block will speak each row of the data result set as a sentence. To speak data returned by a DB Data block in a specific format, Genesys recommends using the Prompt block along with ECMA script. A **template** application (Database Query Result Access Project) is provided which demonstrates the use of ECMA script to allow Prompting of currency and data formats as an example.

Tip

The DB Prompt block speaks out all columns for each record returned by the database as the result of a query. The ordering of columns and of the records is controlled by the query itself and DB Prompt plays them all in the same order without any breaks. To introduce breaks or to add prefix or suffix text to individual columns, you can use a **custom query** and introduce these features in that query. For example: `SELECT 'name ' + employee.firstname + employee.lastname + ' . . .' FROM employee WHERE employee.emp_id < 10`. This query will speak out the text name with a small gap before speaking out each name of each employee returned from the database. After each record, it will pause for a small period due to the `' . . .'` literal in the query.

The DB Prompt block has no page exceptions.

The DB Prompt block has the following properties:

Name Property

Find this property's details under **Common Properties**.

Block Notes Property

Can be used for both callflow and workflow blocks to add comments.

Data Source Property

The Data Source property allows you to select the DB Data block that contains a previously-defined database query. The results of this database query will be used to create the voice prompt. To select the data source (a DB Data block):

1. Select the Data Source row in the block's property table.
2. In the Value field, select the appropriate DB Data block from the drop-down list.

Language Property

The language set by this property overrides any language set by the [Set Language](#) block, the Project preferences, or the incoming call parameters. The property takes effect only for the duration of this block, and the language setting reverts back to its previous state after the block is done. In the case of the DB Prompt block, this property affects the language of grammars of TTS output:

1. Click under Value to display a down arrow.
2. Click the down arrow and select English - United States (en-US) or the variable that contains the language.

Clear Buffer Property

Use the Clear Buffer property for clearing the DTMF digits in the key-ahead buffer. If it is not set to true, the DTMF digits entered are carried forward to the next block. It is commonly used for applications the caller is familiar with. For example, the caller hears a welcome prompt but knows the next prompt will solicit the caller's input or menu selection. The caller may start inputting with DTMF while the welcome prompt plays and expect the input to carry forward. To assign a value to the Clear Buffer property:

1. Select the Clear Buffer row in the block's property table.
2. In the Value field, select true or false from the drop-down list.

Immediate Playback Property

When Immediate Playback is set to true, prompts are played immediately on the execution of the prompt without queuing them. When Immediate Playback is set to false, the interpreter goes to the transitioning state and queues the TTS Prompt until the interpreter waits for an input (such as the Menu, Input, Record, and Transfer blocks). To assign a value to the Immediate Playback property:

1. Select the Immediate Playback row in the block's property table.
2. In the Value field, select true or false from the drop-down list.

Interruptible Property

This property specifies whether the caller can interrupt the prompt before it has finished playing. To assign a value to the Interruptible property:

1. Select the Interruptible row in the block's property table.
2. In the Value field, select true,false,or DTMF (for DTMF barge-in mode support) from the drop-down list.

Prompts Property

Find this property's details under [Common Properties](#). Note: When Type is set to Value and Interpret-As is set to Audio, you can specify an HTTP or RTSP URL. When Type is set to Variable and Interpret-As is set to Audio, you can specify a variable that contains an HTTP or RTSP URL.

Timeout Property

The Timeout property defines the length of the pause between when the voice application plays the last data in the list, and when it moves to the next block. To provide a timeout value:

1. Select the Timeout row in the block's property table.
2. In the Value field, type a timeout value, in seconds.

Condition Property

Find this property's details under [CommonPropertiesforCallflowBlocks](#).

Logging Details Property

Find this property's details under [Common Properties](#).

Log Level Property

Find this property's details under [Common Properties](#).

Enable Status Property

Find this property's details under [Common Properties](#).

Working with Database Blocks

This page contains general information on working with the Database blocks.

Database Connection Profiles

Before you can connect to a database in your application, you need to define a database connection profile that will maintain all information necessary to connect to a particular instance of a database.

Connection Profiles

Profiles + X
Click "+" to add a new profile and "x" to delete a selected profile. Select a profile to edit its details on the Details pane.

ConnectionProfile1

Details
Set the properties of the Connection Profile. Required fields are denoted by "*".

Profile Name* ConnectionProfile1

Connection Pooling Enable

Connection Pool Name

JNDI Namespace java:comp/env

Database Type* MSSQL

Hostname*

Port 1433

Instance Name

Database Name* SID

Username*

Password Show Encrypt

Encryption

Connection String
Preview and add the custom parameters to the Connection String.

The Connection Profile is invalid.

Custom Parameters Test Connection

The **DB Data** block requires that you specify the name of a connection profile in its properties so that it can use that information to connect to the database at runtime. Multiple connections profiles can be defined in one Project and these profiles can be shared by multiple DB Data blocks even if they are in different callflows. A connection profile consists of the basic information required to connect to a database. The information provided in a connection profile includes the following:

- **Profile Name.** The internal name that Composer uses to identify connections uniquely.
- **Connection Pooling.** Select to enable connection pooling, which maintains a set of database connections that can be reused for requests to databases. You can use this feature to enhance performance by avoiding time-consuming re-establishment of connections to databases.
- **Connection Pool Name.** Specify a Java Naming and Directory Interface (JNDI) name for the pooled data source. Composer applications can use any JNDI data source exposed by the web server. The **.war files** exported by Composer contain configuration files to support connection pooling with JBoss and WebSphere; other configuration changes to the web application may be required for other web servers.
- **JNDI Namespace.** Starting with 8.1.410.14, Composer introduces the JNDI Namespace option for Java Composer Projects. The default value is `java:comp/env`. You can edit this value to match your web server/database requirements. For example, you can use JBoss Connection Pooling with MSSQL and Oracle databases for both callflows and workflows.
- **Database Type.** The type of database from the list of supported databases
- **Hostname.** The host on which the database server is running. In case of Database Cluster, Virtual IP/Cluster Alias/SCAN Name is specified here.
- **Port.** The TCP port on which the database server is listening for connections. The most commonly used defaults for supported database types are pre-populated by Composer. If your database server uses custom ports, you will need to specify them here.
- **Instance Name.** The MSSQL Instance that need to connect in SQL Server. Port will take precedence if specified. This field is disabled when Database Type is selected as ORACLE.
- **Database Name.** The name of the database/catalog for SQLServer and the SID in case of Oracle.
- **SID.** The check box to specify if value provided in "Database Name" is SID. This check box is disabled when "Database Type" is MSSQL
- **Username.** The username that should be used to access the database
- **Password.** The password that should be used to access the database
- **Encrypt.** Select the encrypt the password.
- **Show.** Select to show the password
- **Custom Parameters.** The supported custom parameters can be included in connection string along with other parameters. To define custom parameters click the "Custom Parameters" button. In the dialog opened add the parameter name and value, in the order that need to be appended to connection string.

Note: Starting with 8.1.410.14, you can use the DB Data block Connection String property to dynamically access the database at runtime and override the Connection Profile settings in the block.

Important

The Database block does not support database requests using Windows authentication.

Configuration for Database Cluster:

- For MSSQL Cluster, Virtual IP/Cluster Alias is specified in Hostname field of Connection Profile. To

connect to particular named instance in cluster, Instance parameter is configured.

- For ORACLE Cluster, Cluster Alias/SCAN Name is specified in Hostname field of Connection Profile.

Additionally, to enable TAF functionality in ORACLE clusters, connection pool is created similar to pooling capability in other application servers. Connection pool can be created as the example below (This need to be added in Tomcat server.xml present in Composer installed path) <Resource name="jdbc/oraclePooled" auth="Container"

```

    type="com.mchange.v2.c3p0.ComboPooledDataSource"
    factory="org.apache.naming.factory.BeanFactory"
    driverClass="oracle.jdbc.driver.OracleDriver"
    user="scott"
    password="tiger" jdbcUrl="jdbc:oracle:oci:@(DESCRIPTION=(LOAD_BALANCE=on) (FAILOVER=on)
    (ADDRESS=(PROTOCOL=tcp) (HOST=172.21.184.70) (PORT=1521)) (ADDRESS=(PROTOCOL=tcp)
    (HOST=172.21.184.71) (PORT=1521)) (CONNECT_DATA=(SERVICE_NAME=rac.genesyslab.com)
    (FAILOVER_MODE=(TYPE=session) (METHOD=basic))))" />

```

Encryption:

Parameters under "Encryption" tab allows you to configure SSL encryption and server authentication for Database connections made during Design time (Query Builder, Stored Procedure) and Runtime. When security is enabled, SSL encryption is used for all data sent between composer and SQLServer, if the SQL server has a certificate installed.

▼ Encryption

Set connection properties to encrypt the connection to the database

Secure Connection Enable

Trust Certificate Enable

Match Certificate Subject Enable

Certificate Hostname

Trust Store Location

Trust Store Type

Trust Store Password Show

Connection String

Preview and add the custom parameters to the Connection String.

```

jdbc:oracle:thin:@(DESCRIPTION=(ADDRESS=(PROTOCOL=tcps)(HOST=dev-iron)(PORT=1521))(CONNECT_DATA=(SERVICE_NAME=COMPDB1)))
hr/**
javax.net.ssl.trustStore=c:/truststore
javax.net.ssl.trustStoreType=JKS

```

To establish a Secure Database connection from Composer, following parameters are to be configured under encryption tab:

- **Secure Connection.** Enabling this check box will make all connections from Composer to Database Server encrypted with a choice of server authentication
- **Trust Certificate.** Enabling "Secure Connection" and "Trust Certificate" will be sufficient to establish SSL Connection. When "Trust Certificate" is disabled, other optional attributes are enabled to validate server certificate,
- **Match Certificate Subject.** This is enabled in order to force the matching of the certificate subject available in Server Certificate and client's trusted copy.
- **Certificate Hostname.** This parameter is specified in case the client certificate carries a different subject name than the server certificate and user wishes to ignore the difference by providing the subject name expected in the server certificate explicitly.
- **Trust Store Location.** Location where the Trust Store file is present. The trust store file contains all the certificates trusted by the client, including the certificate that the server uses to authenticate itself.
- **Trust Store Type.** JKS truststore is supported when Database Type is ORACLE. This parameter is not editable. This is not applicable when Database Type is MSSQL
- **Trust Store Password.** Password to access the trust store.

Certificate configuration for Secure Connection:

- For Java Composer Projects, when "Secure Connection" is enabled and "Trust Certificate" is disabled, certificates are placed in "TrustStore Location" specified in connection profile.
- For .NET Composer Projects Design time (i.e. for Query Builder and Stored Procedure Builder), certificates are placed in "TrustStore Location" specified in connection profile.
- For .NET Composer Projects Runtime and MSSQL database, certificates are installed in "Certificate Windows Snap-In" accessed from MMC console in Windows.
- For .NET Composer Projects Runtime and ORACLE database, certificates are installed in Oracle wallet both in client and server. tnsnames.ora configuration will have service name with TCPS protocol. Example is given below.

SSLTEST =

```
(DESCRIPTION =
  (ADDRESS_LIST =
    (ADDRESS = (PROTOCOL = TCPS)(HOST = dev-rose.us.int.genesyslab.com)(PORT = 2484))
  )
  (CONNECT_DATA =
    (SERVER = DEDICATED)
    (SERVICE_NAME = SSLTEST)
  )
)
```



Notes:

To establish a connection profile, you must be working with a Project file that was upgraded to Composer 8.0.2 or higher from an earlier Composer release. Connection profiles are not available in Projects created using Composer 8.0. They become available after the Project is upgraded. The method for specifying additional pooling parameters varies based on the database being used and the Project type. Java Composer Projects use the c3p0 library for both SQLServer and Oracle databases. Otherwise, in the case of Oracle databases, Composer uses the c3p0 library and the library exposes its own configuration parameters for pooling via an XML file. In case of SQLServer,

additional pooling parameters can be specified in the connection string.

Creating/Editing a Connection Profile

To create (or edit) a connection profile:

1. Select the Project for which you are creating a connection profile in the Project Explorer, and expand your project folder set.
2. Expand the db folder.
3. Double-click the connection.properties file. The Connection Profiles view opens.
4. To create a new profile, click the **Add Profile**  icon in the Profiles pane. (If you wish to edit an existing profile, you can select an existing profile in the Profiles pane.)
5. In the Details pane, enter (or update) the appropriate information in each field (fields containing the * character are required).
6. Click the **Save Profile**  icon in the upper-right of the Connection Profiles window. You must save the profile in order for it to be available for selection in the Select Connection Profile dialog box.
7. Test the connection profile by clicking the **Test Connection** button to connect to the database.
 - The message Database connection was successful indicates your connection profile successfully connected to the intended database.
 - The message Database connection failed followed by additional details indicates a problem with your connection profile. Update the profile, save it, and test it again.

Note: For information on creating the configuration for the connection pool on the application server side, see [Connection Pooling](#).

Preview Connection Strings

The connection to the database with the specified parameters in the connection profile can be previewed and tested in the Connection profile editor. In case of Java project as the design and runtime connections use JDBC connection, JDBC connection string is available to preview and test. In case of Dotnet projects as the design time uses JDBC connection and runtime uses OLEDB connection, both strings are available to preview and test. **Note:** The Dotnet project must be deployed correctly in IIS to preview the OLEDB connection string. The parameters apart from ones explicitly collected in the editor can be added using the **custom parameters** dialog which takes the parameters as a name value pair.

Using the Query Builder

The Composer Query Builder provides a visual method of building a database query without the need

to type SQL code. The Query Builder is accessed through the **Query Type property** in the DB Data block. It can be used for both voice callflows and routing workflows. **Note:** The Query Builder can only be accessed when a valid connection profile has been created and selected in the **Connection Profile property** of the DB Data block. The Query Builder with an example query is shown below.

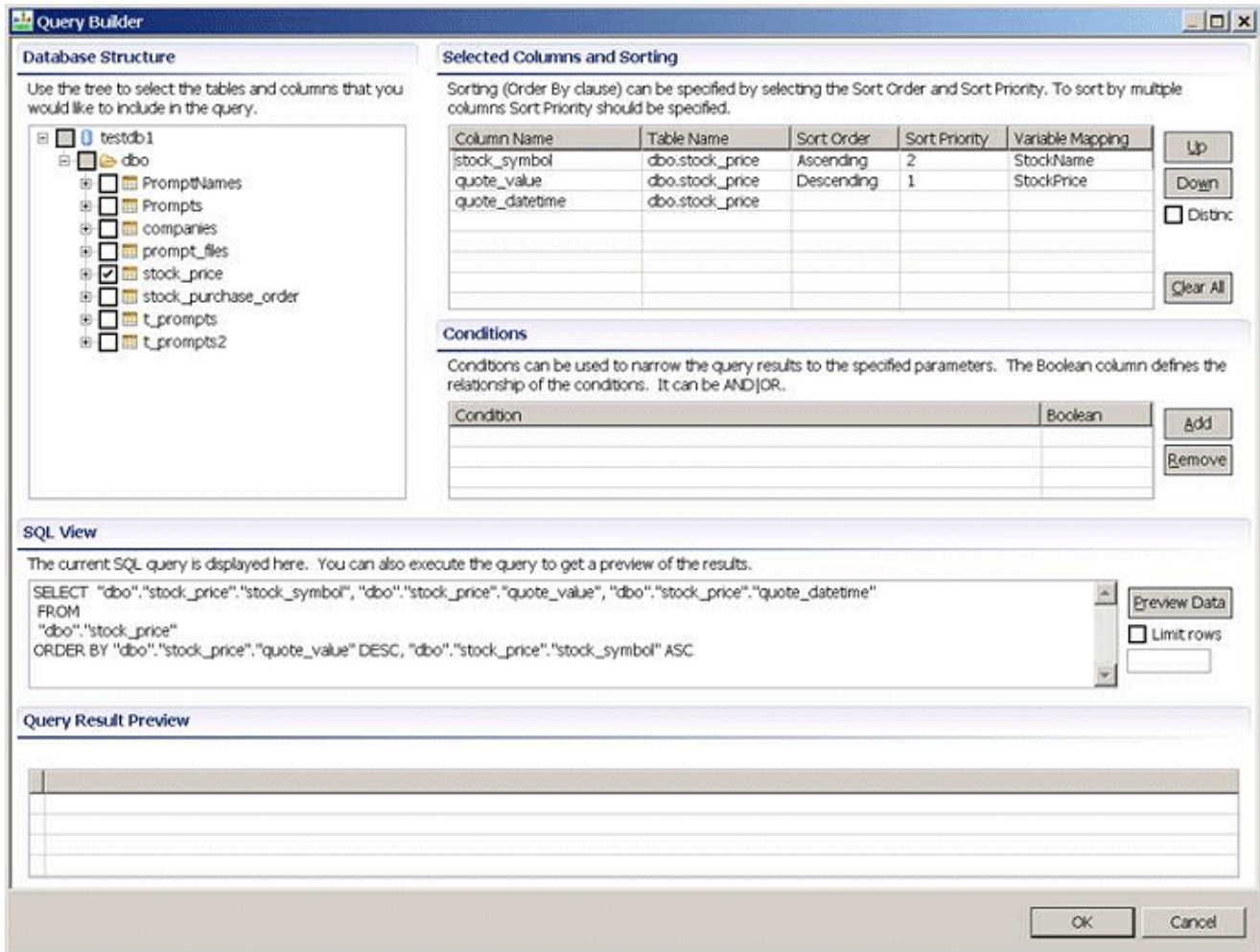

Building a Database Query

The Query Builder opens when Composer is successfully able to connect to the database specified in your connection profile. Any schemas, tables (and table synonyms) and columns of the database accessible from the specified user account are shown in hierarchical format in the Database Structure pane of the Query Builder. In the example below, EMPLOYEEESYNONYM is a table synonym.

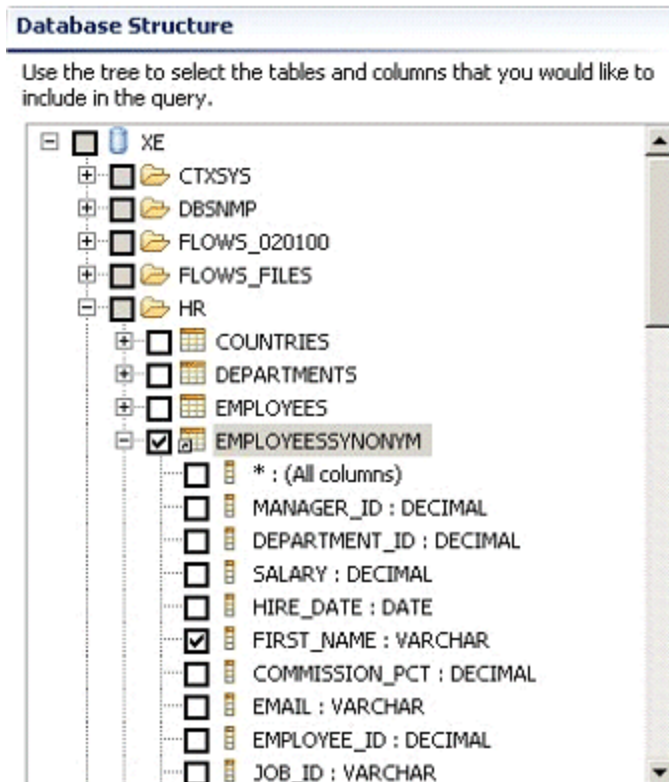

TableSyn.gif

Note: MSSQLServer table synonyms are read from the system table sys.synonyms. Oracle table synonyms are read from the system table user_synonyms. To build a query:

1. Specify which table columns are returned as query results.
 - Select the tables and columns to include in your query by checking appropriate items in the **Database Structure** pane. Expand table entries to see the columns. To select all columns in a table, select the appropriate (**All columns**) check box under the appropriate table.
 - Selected columns and tables appear in the **Selected Columns** pane. To alter the order in which selected columns are returned in query results, use the **Up** and **Down** buttons to reorder columns within the list.
 - To specify the order in which query results should be sorted, click the **Sort Order** field for a column and select a Sort option (**ascending** or **descending**). This will automatically fill in the Sort Order, which indicates the sequence in which multiple sort criteria will be applied. It is possible to sort by multiple columns and you can change the sorting sequence by clicking on the **Sort Priority** column. For example, you might sort a query of names by last name and then sort by first name for those people with the same last name. In that case, last name has Sort Order 1, and first name has Sort Order 2.

Note: The order in which columns appear in the Selected Columns list does not affect the sort order.

- To specify the variables into which the column values need to be copied, click the **Variable Mapping** field for a column and select a variable. If a variable is specified for a column, **DB Data block** execution will result in the column values of the first record being copied into the specified variable. If more than one record is returned by the query, then use the **Looping**

Common Block along with the DB Data block to iterate over records and populate the variables specified for the columns.

2. Specify filter criteria. In the **Conditions** pane, you build the search or filter criteria to identify the data you want to retrieve from the database. You can specify multiple conditions.
 - Click **Add** to create a new condition. A new row will be added to the Conditions list. Click the **Condition** column, and then click the  to open the Condition Builder.
 - Select a column from the **Select Column** drop-down list which the search condition will operate on.
 - Select the operator (=, <>, <, >, and so on) from the **Operator** drop-down list. This operator will be used to compare the specified column with the value specified in the next step.
 - In the **Value** field, type or select your value for the condition depending on the value type option:
 - **Column Reference:** a table column that you can select from a drop-down list. This option will compare the two selected columns based on the specified operator.
 - **Application Variable:** a **variable** defined in your application that can be selected from a drop-down list. At runtime the current value of the selected variable will be used for comparing the column's value based on the specified operator.
 - **Custom Value:** a value that is not validated by the query builder and is added directly to the query. It can be used to specify SQL functions or more complex expression.
 - **Literal:** a value that is interpreted as a string or a number. Type in the literal value. The value will be enclosed in quotes automatically if it is a string. If the literal value represents a number, you will need to enclose it in quotes depending on the data type of the selected column. This option will compare the selected column's value to the specified literal using the specified operator.
 - Click **OK** to complete the condition.
 - Using the above steps, you can define multiple conditions. These conditions can be combined using logical operators to further refine your search criteria. You can select **AND** or **OR** in the **Boolean** field to specify the logical operator.
3. Test your query.
 - To test the query, you can click the **Preview Data** button. This executes the query against the appropriate database. If the database tables contain data and if any records match the specified conditions, they will be displayed in the Query Results Preview pane. A message will also show the number of records returned as a result of the query.
 - If you expect that the number of matching records will be large and want to preview a subset of returned data, click the **Limit Rows** check box and enter a numeric value to limit the number of returned results.

Note: The message will now show the number of records displayed rather than the actual number of matching records. The query results preview is shown in the Query Result pane.

- Click **OK** to save your query and update the **DB Data** block with the new query. If you click Cancel, all changes are discarded and no changes are made to the DB Data block.

Specifying Custom Queries

The **DB Data** block can use queries specified in a SQL (.sql) file in your Project instead of a query created using the **Query Builder**. To use a custom query:

- Create a .sql file in your db folder and specify the filename in the **Query File** property of the DB Data block. Make sure that the operation type is **SQLScriptFile**. Composer will read this file at runtime and use it to query the specified database.

The ability to use custom queries is useful in cases where the SQL query is already created using other tools, or if the query uses features not supported by the Visual Query Builder. The next topic describes **limitations** of the query builder.

Important

If you are specifying a custom query, Composer currently supports executing only a single SQL statement at run-time though multiple statements might work for certain DB engines.

Application Variables

You can use Application variables in custom query files as part of the SQL statement. To use a variable, include its name within curly braces without the AppState. prefix. For example, the following statement uses varname1 and varname2. Their values will be substituted at the time the DB Data block queries the database. `SELECT name_of_function({varname1}, {varname2}) from dual` Results of the query are stored in a variable as a two-dimensional JSON array. This data can then be accessed via a **Looping Common Block** or via scripting in the Assign or **ECMAScript block**. For example, if the database result set looks like this in tabular form:

Vegetables	Animals
lettuce	chicken
broccoli	lion

The JSON for the result will look like this: `{"db_result": [{"lettuce", "chicken"}, {"broccoli", "lion"}], "db_result_columns": ["vegetables", "animals"]}` **Note:** An example of custom queries is in the Database Stocks Template application.

1. Specify which stored procedure should be executed.
2. Select the stored procedure to execute by checking appropriate item in the Database Structure pane.
3. Parameters and Return Value appear in the Parameters pane. Specify the value (application variable) for each of the parameter into which the output value is stored after the stored procedure has executed.
4. To test the stored procedure, click the **Execute** button. This executes the stored procedure in the appropriate database. If the stored procedure returns any records, they are displayed in the Query Results Preview pane. Any output values are displayed in the Query Result Parameters pane. A message shows the number of records returned as a result of the query.
5. Click **OK** to save your query and update the DB Data block with the new query. If you click Cancel, all changes are discarded and no changes are made to the DB Data block.

Note: Composer does not support the REF CURSOR return type in a stored procedure.

Password Encryption

Composer can now encrypt the database connection profile passwords so that they are not written in the clear to the connection.properties file.

Encryption Key

In order to enable encryption, you must first create an encryption key. Composer requires a 128-bit (16 bytes) key, in hex-encoded format. This can be randomly generated by the OpenSSL tool, using the following command line:

```
$ openssl rand -hex 16 75b8ec9a3ce60a21c4f94236a1b55fb2
```

Any random source will do. Another example is <http://www.random.org/cgi-bin/randbyte?nbytes=16&format=h> (With this example, you will have to remove the spaces in the output.)

Save the encryption key to a text file. Note that this file should be securely stored, so that it can only be read by the Composer process and the backend Tomcat/IIS processes.

Configuring Composer Preferences

In the **Composer > Security** preference page, set the Encryption Key Location preference to point to the encryption key file created in the previous step.

Encrypting the Database Connection Profile Password

In the Connection Profile Editor, next to the Password field, enable the **Encrypt** checkbox. Now, when you save the Connection Profile, the password will be scrambled in the connection.properties file.

Enabling Decryption in the Backend

When the application runs, the application server will need to be able to decrypt the password so that it can connect to the database. For this, the application needs to be configured with the location of

the encryption key file.

Java Composer Projects

If it doesn't already exist, create the file WEB-INF/composer.properties inside the project. Inside the file, enter the following line:

```
composerEncryptionKey=C:\\secrets\\encryption-key.txt
```

(Note that the backslashes here must be escaped.)

.NET Composer Projects

Edit the web.config file's appSettings entry:

```
<appSettings>
  <add key="composerEncryptionKey" value="C:\\secrets\\encryption-key.txt" />
  ...
</appSettings>
```

(Backslashes here are fine.)

Limitations and Workarounds

The Query Builder supports creating SELECT statements. The following is a list of limitations along with suggested workarounds:

- INSERT, UPDATE, and DELETE statements cannot be created using the Query Builder. Advanced SQL features, such as outer joins, subqueries, and unions are also not supported. A [custom query](#) can be used to overcome these limitations.
- if you rename a [DB Data](#) block, its corresponding SQL statement file in the db folder will not be updated and will not be valid until you generate code again.
- For details on SQL datatypes supported by Composer, see [Supported SQL Datatypes](#).

Oracle Client Setup for IIS

To set up an Oracle client for Internet Information Services:

1. Install the Oracle client components on the application server.
2. Create a `tnsnames.ora` file in the `C:\\oracle\\ora81\\network\\ADMIN` folder where `C:\\oracle` is the installation folder of Oracle client components.
3. Add the following lines to `tnsnames.ora` where `COMPDB1` is any alias of choice, `XYZ` is the Oracle server, `COMPOSER` is the **Service Name** as configured on the Oracle listener (server). After doing this,

you should be able to connect to Oracle using `sqlplus user/pwd@COMPDB1` as the command at the command prompt.

```
COMPDB1 = (DESCRIPTION = (ADDRESS_LIST = (ADDRESS = (PROTOCOL = TCP)(HOST =
XYZ.us.int.genesyslab.com)(PORT = 1521)) ) ) (CONNECT_DATA = (SERVICE_NAME =
COMPOSER) ) )
```

4. Create a System DSN using the Data Sources (ODBC) under **Administrative Tools**.
5. Make sure that **Data Source Name** specified above is exactly same as the **Database Name** specified in the Composer database connection profile and **TNS Service Name** is the same as the alias in step 3.
6. Click **Test Connection** in the database connection profile. The connection should be successful and the Composer VXML application should be able to connect to the database.

Steps 4, 5 and 6 can be avoided if the alias used in the `tnsnames.ora` file is same as the database name specified in Composer.

Working with Oracle 12c R2 from Composer .NET projects

Starting with release 8.1.450.20, Composer supports Oracle 12c R2. Perform the following steps to work with Oracle 12c R2 from Composer .NET projects:

1. Download and install the Oracle 12c client. An Oracle 12c client is required to connect to an Oracle 12c database (the Oracle 12c client can be either 32-bit or 64-bit).
2. Register the **ORAOLEDB.Oracle** DLL file on the client machine as follows:
 1. Open the Command Prompt in *administrator* mode on the client machine.
 2. Browse to the Oracle Client installed path and identify the **OraOLEDB12.dll** file.
 3. Execute the command, `C:\Windows\System32\regsvr32.exe OraOLEDB12.dll`, to register the **OraOLEDB12.dll** file.
3. Oracle 12c client bitness and IIS bitness configuration must match. Both must be either 32-bit or 64-bit.
 1. Navigate to *IIS Manager > Application Pools*.
 2. Click the advanced settings of the pool used by the project (usually *DefaultAppPool*).
 3. Use the **Enable 32-bit Application** option to adjust IIS bitness as required.

Supported SQL Datatypes

Composer's **DB Data Block** can access many common types of data stored in supported databases. The following tables summarize the level of support that Composer provides. The tables are organized by the Composer project type (Java or .NET), and by whether you're doing a standard SQL query or executing a stored procedure. The levels of support that Composer claims:

The levels of support that Composer claims:

?	Datatype is fully supported.
?*	Datatype is supported, but in the Composer UIs (Query Builder and Stored Procedure Helper), it may appear as "Unknown" or "Other." The queries themselves will work
?	Datatype is not currently supported.

Supported SQL Server Datatypes

Datatype	Java Project SQL query	Java Project Stored Procedure	.NET Project SQL query	.NET Project Stored Procedure
bigint	?	?	?	?
int	?	?	?	?
decimal	?	?	?	?
int	?	?	?	?
numeric	?	?	?	?
smallint	?	?	?	?
tinyint	?	?	?	?
float	?	?	?	?
real	?	?	?	?
date	?	?	?	?
datetime	?	?	?	?
datetimeoffset	?*	?*	?*	?*
char	?	?	?	?
text	?	?	?	?
varchar	?	?	?	?
nchar	?	?	?	?
ntext	?	?	?	?
nvarchar	?	?	?	?

Datatype	Java Project SQL query	Java Project Stored Procedure	.NET Project SQL query	.NET Project Stored Procedure
binary	?	?	?	?
sql_variant	?	?	?*	?
timestamp	?	?	?	?

Supported Oracle Datatypes

Datatype	Java Project SQL query	Java Project Stored Procedure	.NET Project SQL query	.NET Project Stored Procedure
number	?	?	?	?
binary_float	?*	?*	?*	?*
binary_double	?*	?	?*	?*
date	?	?	?	?
char	?	?	?	?
varchar	?	?	?	?
varchar2	?*	?*	?*	?*
nchar	?*	?	?*	?
nvarchar2	?*	?	?*	?*

Voice CTI Blocks

CTI (which stands for *Computer Telephony Integration*) blocks provide interfaces between Genesys Voice Platform (GVP) and Genesys Framework components and SIP Server. There are six CTI blocks:

- **Get Access Number Block** for using Get access number to retrieve the access code (number) of a remote site from an IVR Server.
- **Interaction Data Block** for sending attached data. Get and Put operations are supported.
- **Route Request Block** for sending route requests. It uses the Userdata extension attribute for sending back data attached to an interaction (attached data).
- **Statistics Block** to retrieve statistics from Stat Server via IServer.
- **ICM Interaction Data Block** to work with a Cisco product called Intelligent Contact Management (ICM), which provides intelligent routing and Computer Telephony Integration. You can use the GVP ICM Adapter in VoiceXML applications when invoking services, responding to requests, and sharing data.
- **ICM Route Request Block** to transfer a call to Intelligent Contact Management.

Also see [Working with CTI Applications](#).

CTI Scenarios: SIPS versus CTIC

Composer will generate code for both SIP Server and CTI Connection scenarios simultaneously. The code to be executed at runtime depends on which scenario is active when the voice application runs. No decision is required at design time. For more information, see the topic [CTI Scenarios](#). Also see the [VoiceXML Reference](#) on the [Genesys Voice Platform Wiki](#).

CTI Scenarios

There are feature differences between the SIPS and CTIC scenarios. The following table gives a summary of the **CTI blocks**, and for each CTI block it lists the differences in behavior for the two CTI scenarios.

CTI Block Name	Supports CTIC Case?	Supports SIPS Case?	Comments
Interaction Data	Yes	Yes	<p>Supported operations in each scenario:</p> <p>CTIC:</p> <ul style="list-style-type: none"> • PUT • GET • DELETE • DELETEALL • REPLACE <p>SIPS:</p> <ul style="list-style-type: none"> • PUT • GET <p>Types of interaction data supported: CTIC:</p> <ul style="list-style-type: none"> • USERDATA <p>SIPS:</p> <ul style="list-style-type: none"> • USERDATA
Get access number	Yes	No	<p>Get access number block can only be used in the CTIC scenario.</p> <p>Types of interaction data supported: CTIC:</p> <ul style="list-style-type: none"> • USERDATA • EXTENSIONDATA
Statistics	Yes	No	<p>Statistics block can only be used in the CTIC scenario.</p>
Route Request	Yes	Yes	<p>Types of interaction data supported:</p> <p>CTIC:</p>

			<ul style="list-style-type: none"> • USERDATA • EXTENSIONDATA <p>SIPS:</p> <ul style="list-style-type: none"> • USERDATA <p>Types of transfers supported: CTIC:</p> <ul style="list-style-type: none"> • Blind • Bridge <p>SIPS:</p> <ul style="list-style-type: none"> • Consultation • Blind • bridge
--	--	--	---

In case a CTI block or feature is used in a CTI scenario in which it is not supported, appropriate exceptions will be thrown at runtime indicating that the feature is not supported. The table below gives a list of all exceptions that can be thrown by CTI blocks and other possible CTI-related exceptions that can be thrown if errors are encountered at runtime.

Block(s)	Exception	Error Message	Description
Interaction Data Get access number Statistics	error.com.genesyslab.composer.InvalidKey	Missing <block name> key <key name>	This is the event error for handling an invalid key name.
Interaction Data Get access number Statistics Route Request	error.com.genesyslab.composer.OperationTimeout	Operation timed out	This exception will be thrown when a <receive> operation, executed in the context of a CTIC specific operation, times out.
Interaction Data Get access number Statistics Route Request	error.com.genesyslab.composer.receiveError	<Error string returned by CTIC>	If the <receive> fails and an error is reported by CTIC, this exception will be thrown.
Interaction Data	error.com.genesyslab.composer.UnsupportedOperation	Delete operation not supported using SIPServer.	If the user wants to do a userdata DELETE in the CTI using SIPS scenario.
Interaction Data	error.com.genesyslab.composer.UnsupportedOperation	DeleteAll operation not supported using SIPServer.	If the user wants to do a userdata DELETEALL in the CTI using SIPS scenario.
Interaction Data	error.com.genesyslab.composer.UnsupportedOperation	Replace operation not supported using SIPServer.	If the user wants to do a userdata REPLACE in the CTI using SIPS scenario.

Get access number	error.com.genesyslab.composer.unsupported	AccessNumGet operation not supported in case of CTI using SIPServer.	If the user wants to do a AccessNumGet in the CTI using SIPS scenario.
Statistics	error.com.genesyslab.composer.unsupported	Statistics block not supported in case of CTI using SIPServer.	If the user wants to do a PeekStatReq or GetStatReq in the CTI using SIPS scenario.
Route Request	error.com.genesyslab.composer.unsupported	Consultation transfer is not supported in case of CTI using CTIConnector.	If user sets Transfer type to consultation in case of CTI using SIPS.

Get Access Number

The Get access number block uses Get access number to retrieve the access code (number) of a remote site from an IVR Server. It can be used to get the agent number when the application transfers a call to an agent at a remote site (remote switch transfers).

Notes:

- This block can be used in CTIC scenario only. It will not work when CTI functionality is accessed using SIP Server.
- This block is not supported when GVP is configured in Network mode.

Get Access Number Block Exception Events

The Get access number block has four exception events as described in [Exception_Event_Descriptions](#):

`error.com.genesyslab.composer.invalidkey` `error.com.genesyslab.composer.receiveerror`
`error.com.genesyslab.composer.operationtimeout` `error.com.genesyslab.composer.unsupported`
(preselected into the Supported column as a default exception)

The Get access number block has the following properties:

Name Property

Find this property's details under [Common Properties](#).

Block Notes Property

Can be used for both callflow and workflow blocks to add comments.

Exceptions Property

Find this property's details under [Common Properties](#). The exception `error.com.genesyslab.composer.unsupported` is preselected into the Supported column of the Exceptions dialog box as a default exception.

Variables Property

To declare session variables for the application or subcallflow:

1. Select the Variables row in the block's property table.
2. Click the  button to open the Variable Settings dialog box.

These variables apply only to the **Entry block**, unless otherwise indicated.

Note: Request URi parameters created in IVR Profiles during the VoiceXML application provisioning are passed to the Composer generated VoiceXML application as request-uri parameters in the `session.connection.protocol.sip.requesturi` session array. An Entry block variable can use these parameters by setting the following expressions to the variable values: `typeof session.connection.protocol.sip.requesturi['var1'] == 'undefined' ? "LocalDefaultValue" : session.connection.protocol.sip.requesturi['var1']`. If parameters are set as part of IVR Profiles provisioning in the Genesys VoiceXML provisioning system, and if these parameters have the same names as variables set in the Entry block's **Variables** property with the above mentioned `sip.requesturi` expression, then the SIP-Request-URI parameters will take precedence over the user variable values set in the Entry block.

Many blocks enable the use of variables rather than static data. For example, the **Prompt** block can play the value of a variable as Text-to-Speech. Variables whose values are to be used in other blocks must be declared here so that they appear in the list of available variables in other blocks.

The value collected by an **Input** block or a **Menu** block is saved as a session variable whose name is the same as the block name.

Destination Dn Property

To enter a Destination Dn:

1. Select the Destination Dn row in the block's property table.
2. In the Value field, type a Destination Dn.

Remote Switch Location Property

To enter a remote switch location:

1. Select the Remote Switch Location row in the block's property table.
2. In the Value field, type a value specifying the remote switch location.

Remote switch transfers use the `AccessNumGet` message, which is sent by the IVR to the IVR Server to request that the call be routed to a remote site. For information on `AccessNumGet` and the `Location` parameter, refer to the IVR SDK XML Developer's Guide, which is available on the Genesys Technical Support website or on the Developer Documentation Library DVD. Refer to the `Location`

parameter. The value of the Location parameter will be the name of the switch defined in the Configuration Database.

Output Result Property

You must use the Output Result property to assign the collected data to a user-defined **variable** for further processing.

Note! This property is mandatory. You must select a variable for the output result even if you do not plan on using the variable. If this is not done, a validation error will be generated in the Problems view.

1. Select the Output Result row in the block's property table.
2. In the Value field, click the down arrow and select a variable.

For more information, see [Upgrading Projects and Diagrams](#).

Condition Property

Find this property's details under [Common Properties for Callflow Blocks](#).

Logging Details Property

Find this property's details under [CommonPropertiesforCallflowBlocks](#).

Log Level Property

Find this property's details under [Common Properties for Callflow Blocks](#).

Enable Status Property

Find this property's details under [Common Properties for Callflow Blocks](#).

Interaction Data Block

Use the Interaction Data block for sending attached data. Get and Put operations are supported. Background: Attached data can be attached to calls by different T-Server clients. For example, an IVR might attach data to a call by collecting the numbers that callers press on their telephone keypads in response to a prompt. An agent might also attach data to a call using a desktop application. Once T-Server attaches the data, it becomes interaction data, which can be used in [expressions](#) and for reporting. T-Server stores attached data in AttributeUserData of event messages.

- Get values are extracted from the [User Data](#) received at the start of the call as part of the INVITE to the GVP.
- For Put , the NGI extension <send> tag will be used to send data immediately to the SIP Server. The data will be sent in the SIP INFO Body.

This block supports working with both SIPServer and CTIConnector CTI scenarios. There are feature differences as listed in [CTI scenarios](#). Also see the standard VoiceXML session variables documented in the GVP 8.1 VoiceXML 2.1 Reference Help (Help > Contents). The Interaction Data block has the following properties:

Name Property

Find this property's details under [Common Properties](#).

Block Notes Property

Can be used for both callflow and workflow blocks to add comments.

Exceptions Property

Find this property's details under [Common Properties](#). The Interaction Data block has the following [Exception Events](#):

- error.com.genesyslab.composer.receiveerror
- error.com.genesyslab.composer.operationtimeout
- error.com.genesyslab.composer.unsupported (pre-selected as a default exception)
- error.com.genesyslab.composer.invalidkey

Operation Property

This property indicates the type of operation to perform:

- get--to fetch the user data (CTIC and SIPS)
- put--to send updated user data (CTIC and SIPS)
- delete--to delete selected user data (CTIC only)
- deleteall--to delete all user data (CTIC only)
- replace--to replace existing user data with alternate user data (CTIC only)

To select a value for the Operation property:

1. Select the Operation row in the block's property table.
2. In the Value field, select get, put, delete, deleteall, or replace from the drop-down list.

Note: delete, deleteall, and replace are not supported for CTI using SIP Server.

Values Property

The Values property holds the list of variables to be fetched or sent. The name of the variable must match the UserData key name. Note: All key names for attached data passed from an IRD Strategy must be in all lower case. To select values:

1. Click the Values row in the block's property table.
2. Click the  button to open the Values dialog box.
3. Select individual global **variables**, or click Select all or Deselect all.

Condition Property

Find this property's details under [Common Properties for Callflow Blocks](#) or [Common Properties for Workflow Blocks](#).

Logging Details Property

Find this property's details under [Common Properties for Callflow Blocks](#) or [Common Properties for Workflow Blocks](#).

Log Level Property

Find this property's details under [Common Properties for Callflow Blocks](#) or [Common Properties for Workflow Blocks](#).

Enable Status Property

Find this property's details under [Common Properties for Callflow Blocks](#) or [Common Properties for Workflow Blocks](#).

1. Click OK.

Route Request Block

Use the Route Request block for sending route requests. It uses the Userdata extension attribute for sending back data attached to an interaction (**User Data**). Attached data can be attached to calls by different T-Server clients. For example, an IVR might attach data to a call by collecting the numbers that callers press on their telephone keypads in response to a prompt. An agent might also attach data to a call using a desktop application. Once T-Server attaches the data, it becomes interaction data, which can be used in **expressions** and for reporting. T-Server stores attached data in AttributeUserData of event messages. You can select any application variables to pass as interaction data. The name of the variable will be used as the Key of the interaction data. The Destination number represents the target to which the call will be routed. It can be one of following:

- Virtual Route Point Destination Number
- Direct extension of an Agent
- External Number to dial out

This block supports working with both SIPServer and CTIConnector CTI scenarios. There are feature differences as listed in **CTI scenarios**. The Route Request block has the following properties:

Name Property

Find this property's details under **Common Properties**.

Block Notes Property

Can be used for both callflow and workflow blocks to add comments.

Exceptions Property

Find this property's details under **Common Properties**. The Route Request block supports the following **Exception Event Descriptions**:

- connection.disconnect.hangup
- connection.disconnect.transfer
- error
- error.com.genesyslab.composer.unsupported
- error.connection.baddestination (supported by default)
- error.connection.noauthorization

-
- `error.connection.noresource`
 - `error.connection.noroute`
 - `error.connection`
 - `error.unsupported.transfer.blind`
 - `error.unsupported.transfer.consultation`
 - `error.unsupported.uri`

Language Property

The language set by this property overrides any language set by the [Set Language](#) block, the Project preferences, or the incoming call parameters. The property takes effect only for the duration of this block, and the language setting reverts back to its previous state after the block is done. In the case of the Route Request block, this property affects the language of grammars used for ASR input:

1. Click under Value to display a down arrow.
2. Click the down arrow and select English - United States (en-US) or the variable that contains the language.

Condition Property

Find this property's details under [Common Properties for Callflow Blocks](#) or [Common Properties for Workflow Blocks](#).

Logging Details Property

Find this property's details under [Common Properties for Callflow Blocks](#) or [Common Properties for Workflow Blocks](#).

Log Level Property

Find this property's details under [Common Properties for Callflow Blocks](#) or [Common Properties for Workflow Blocks](#).

Enable Status Property

Find this property's details under [Common Properties for Callflow Blocks](#) or [Common Properties for Workflow Blocks](#).

Interaction Data Property

To select session variables:

1. Click the Interaction Data row in the block's property table.
2. Click the  button to open the Interaction Data dialog box.
3. Select individual global **variables**, or click Select all or Deselect all.
4. Click OK.

Transfer Audio Property

The optional Transfer Audio property plays a prompt to the end user while the number is being dialed out. You provide the URI of the audio source to play while the transfer attempt is in progress (before the other end answers). If the callee answers, the interpreter terminates playback of the recorded audio immediately. If the end of the audio file is reached and the callee has not yet answered, the interpreter plays the audio tones from the far end of the call (ringing, busy). If the resource cannot be fetched, the error is ignored and the transfer continues. To provide a Transfer Audio value:

1. Select the Transfer Audio row in the block's property table.
2. In the Value field, type a Transfer Audio value URI (HTTP or RTSP) specifying the location of the audio file to play.

Aai Property

Use the optional Application-to-Application Information (the Aai property) for the data that is to be transferred from the current application to another application. Use this option to transfer the call to a number that initiates another voice application. To assign a value to the Aai property:

1. Select the Aai row in the block's property table.
2. In the Value field, select a value from the drop-down list.

Values are the Voice Application Variables described under the [Variables Property](#).

Connect Timeout Property

Use the Connect Timeout property for the connection timeout value. The default is 30 seconds. To provide a timeout value:

1. Select the Connect Timeout row in the block's property table.
2. In the Value field, type a timeout value, in seconds.

Destination Property

The Destination property contains the destination phone number. The destination number can be one of the following:

- A Virtual Route point number on which the IRD Strategy is loaded
- Extension number of an Agent
- External number

The value must be specified in one of the formats below:

- sip:[user@]host[:port]
- tel:phonenumber e.g., tel:+358-555-1234567

For information on this property, select Help > Contents and see the Genesys Voice Platform document [VoiceXML Reference Help](#). Specifically see Standard VoiceXML > Variables > Transfer, attribute dest. To assign a value to the Destination property:

1. Select the Destination row in the block's property table.
2. In the Value field, select a value from the drop-down list.

Values are the Voice Application [Variables](#) described in the Entry block.

Max Call Duration Property

Use the Max Call Duration property for the maximum call duration. The default is 3600 seconds. (This is not supported for Consultation Transfer Type.) Note: If this is set to 0 (zero), an infinite value is supplied, and there is no upper limit to the call duration. To provide a value for the maximum call duration:

1. Select the Max Call Duration row in the block's property table.
2. In the Value field, type a value for the maximum call duration.

Transfer Type Property

The Transfer Type property specifies the type of transfer required. To assign a value to the Transfer Type property:

1. Select the Transfer Type row in the block's property table.
2. In the Value field, select one of the following from the drop-down list:

Note: The selected transfer type will work only if the platform is provisioned to support that type of transfer.

Blind

This is the default setting. The platform redirects the caller to the agent without remaining in the connection, and it does not monitor the outcome. The platform generates a `connection.disconnect.transfer` event immediately, regardless of the transfer outcome.

Bridge

The platform adds the agent to the connection, and it remains in the connection for the duration of the transferred call. Any included grammars control the listening during the transfer. Control of the call always returns to the application when the transfer ends, regardless of the transfer result. If the caller or network disconnects the call, the platform generates `connection.disconnect.hangup` event. If the agent disconnects the call, the transfer outcome is set to `far_end_disconnect`. Note: Use this option if the application needs to continue in self-service after the agent and caller communication is over; for example, to present a survey to the end user.

Method Property

The Method property specifies the type of route request required. To assign a value to the Method property:

1. Select the Method row in the block's property table.
2. In the Value field, select one of the following from the drop-down list:

Bridge

A Bridge method indicates that the Media Control Platform (MCP) bridges the media path.

1. The platform sends an INVITE request to the callee, and a dialog is established between the callee and the platform.
2. The route request fails if a non-2xx final response is received for the INVITE request.

This is a two-leg route request (in other words, it occupies two channels on the platform). The platform stays in the signaling path and is responsible for bridging the two call legs.

Hkf (Hookflash)

A Hookflash method indicates a route request using DTMF digits (RFC 2833).

1. The Media Control Platform (MCP) sends DTMF digits on the media channel. The platform leaves it to the media gateway or switch to perform the route request on the network.
2. Configurable options enable you to specify whether the call will be disconnected by the platform or by the remote end. Otherwise, the call is disconnected after a configured timeout.

This is a one-leg route request (in other words, it occupies only one channel on the platform).

Refer

A Refer method indicates that the route request is based on a SIP REFER message (RFC 3515).

1. The platform sends a REFER request to the caller, with the callee (as specified in the VoiceXML application) in the Refer-To: header.
2. The route request fails if a non-2xx final response is received for the REFER.

This is a one-leg route request (in other words, it occupies only one channel on the platform).

Referjoin

A Referjoin method indicates a consultative REFER route request (RFC 3891).

1. The platform sends an INVITE request to the callee, and a dialog is established between the callee and the platform.
2. The platform also sends a REFER request to the caller, with the callee's information in the Replaces header.
3. The platform considers the route request to be successful if it receives a BYE from the caller after a 2xx response for the REFER.
4. The route request fails if a non-2xx final response is received for the INVITE request or for the REFER request.

This is a two-leg, or join-style, route request (in other words, it occupies two channels on the platform).

Mediaredirect

A Mediaredirect method indicates a media redirection route request. The Media Control Platform (MCP) uses SIP to handle call control between the caller and the callee, and the RTP media channel is connected directly between the caller and callee.

1. The platform sends an INVITE request to the callee without SDP.
2. If the route request is proceeding, the callee responds with a 200 OK that includes an SDP offer.
3. The platform forwards the SDP offer in a re-INVITE request to the caller.
4. The caller responds with a 200 OK that includes the SDP answer.
5. The platform forwards the SDP answer to the callee in an ACK response.
6. The route request fails if a non-2xx final response is received for the initial INVITE request.

This is a two-leg route request (in other words, it occupies two channels on the platform).

Get Shadow Variables Property

Shadow variables provide a way to retrieve further information regarding the value of an input item.

By setting this property to true, it will expose the block's shadow variable within the callflow. When enabled, the shadow variable will be included in the list of available variables. (For example, the Log block's Logging Details will show RouteRequest1\$.) A shadow variable is referenced as `blockname$.shadowVariable`, where `blockname$` is the value of the input item's name attribute, and `shadowVariable` is the name of a specific shadow variable, for example: `RouteRequest1$.duration`. To assign a value to the Get Shadow Variables property:

1. Select the Get Shadow Variables row in the block's property table.
2. In the Value field, select true or false from the drop-down list.

Transfer Results Property

To select transfer results:

1. Click the Transfer Results row in the block's property table.
2. Click the  button to open the Transfer Results dialog box.
3. Select items from the list of available CPA results, or click Select all or Deselect all as needed, then click OK.

For each item selected, an output node is added to allow specific actions to be taken for that condition.

Input Grammar Dtmf Property

Use the Input Grammar Dtmf property to specify the DTMF Grammar for the Input Block. The DTMF Grammar is processed and handled by GVP. In the case of external grammars, this specifies the actual path of the grammar file / resource for DTMF Grammars. This is only valid when the Grammar Type is externalGrammar and Input Mode is dtmf or hybrid. To assign a value to the Input Grammar Dtmf property:

1. Select the Input Grammar Dtmf row in the block's property table.
2. In the Value field, select a value from the drop-down list.

Values are the Voice Application Variables described under the Variables Property.

Input Grammar Voice Property

Use the Input Grammar Voice property to specify the Voice Grammar for the Input block. If you are writing hybrid applications that allow both DTMF and Speech input, specify both the DTMF and Voice grammars. The Voice Grammar is sent to the ASR Engine for processing, whereas the DTMF grammar is processed by GVP. As a result, you need two separate grammars for Voice and DTMF in the case of hybrid applications that allow both Voice and DTMF inputs. In the case of external grammars, this specifies the actual path of the grammar file / resource for ASR Grammars.. This is only valid when

Grammar Type is externalGrammar and Input Mode is voice or hybrid. To assign a value to the Input Grammar Voice property:

1. Select the Input Grammar Voice row in the block's property table.
2. In the Value field, select a value from the drop-down list.

Values are the Voice Application Variables described under the Variables Property.

Input Mode Property

To assign a value to the Input Mode property:

1. Select the Input Mode row in the block's property table.
2. In the Value field, select one of the following from the drop-down list:

DTMF

The DTMF format indicates the menu option mode of input will be via the telephone keypad.

Voice

The Voice format indicates the menu option mode of input will be a voice phrase. The Hybrid menu mode will handle both DTMF and Voice inputs, that is via telephone keypad and voice phrase.

Statistics Block

Use the Statistics block to retrieve statistics from Stat Server via IServer. The Statistics block enables you to receive data on statistics such as CurrNumberWaitingCalls and ExpectedWaitTime. Additionally, you can get a full report on the requested statistics for a specified object in the Configuration Layer. The object may be a queue, route point, or group of queues.

This block supports the following actions (operations):

- GetStatReq
- PeakStatReq

The Statistics block also uses the <send> tag.

Note: This block can be used in CTIC scenario only. It will not work when CTI functionality is accessed using SIPServer.

The Statistics block has the following properties:

Name Property

Find this property's details under [Common Properties](#).

Block Notes Property

Can be used for both callflow and workflow blocks to add comments.

Exceptions Property

Find this property's details under [Common Properties](#). The Statistics block has four page **exceptions**:

- error.com.genesyslab.composer.invalidkey
- error.com.genesyslab.composer.receiveerror
- error.com.genesyslab.composer.operationtimeout
- error.com.genesyslab.composer.unsupported (pre-selected by default)

Operation Property

The Operation property indicates the type of operation to perform:

- **get**—to execute a GetStatReq to return the current value of the requested statistics for the specified object (queue, routepoint, or group of queues)
- **peek**—to execute a PeekStatReq to return the value of CurrNumberWaitingCalls or ExpectedWaitTime. It cannot return any other value.

To select a value for the Operation property:

1. Select the Operation row in the block's property table.
2. In the Value field, select get or peek from the drop-down list.

The following properties apply and must be set if you choose get:

- Object Id
- Object Type
- Server Name
- Statistic Type

The following property applies and must be set if you choose peek:

- Peek Return Value

Note: Statistics can be requested at any time during the call. They must be preconfigured in Genesys Administrator before they can be used. For more information on configuring statistics, see the Framework Stat Server User's Guide.

Object Id Property

The Object Id property is used for a GetStatReq (get) operation.

This property works with the Object Type property.

- For RoutePoint, the value is the Alias of the corresponding DN in the Configuration Database.
- For Queue and GroupQueues, the value is the name of the corresponding object in the Configuration Database.

To provide a value for the Object Id:

1. Select the Object Id row in the block's property table.
2. In the Value field, type a value for the Object Id.

Object Type Property

The Object Type property is used for a GetStatReq (get) operation. As described in the Stat Server Object Types chapter in the Framework Stat Server User's Guide, valid Object types are:

- Queue
- RoutePoint
- GroupQueues

To provide a value for the Object Type:

1. Select the Object Type row in the block's property table.
2. In the Value field, type a value for the Object Type.

Server Name Property

The Server Name property is used for a GetStatReq (get) operation. This can be the IP address/hostname or the fully qualified domain name of the Stat Server.

To provide a value for the Server Name:

1. Select the Server Name row in the block's property table.
2. In the Value field, type a value for the Server Name.

Statistic Type Property

The Statistic Type property is used for a GetStatReq (get) operation. Refer to the Framework Stat Server User's Guide for details on what the values of these objects can be.

To provide a value for the Statistic Type:

1. Select the Statistic Type row in the block's property table.
2. In the Value field, type a value for the Statistic Type.

Peek Return Value Property

The Peek Return Value property is used for a PeekStatReq (peek) operation. This specifies the application variable to hold the result—the current number of calls in the queue.

To select a value for the Peek Return Value property:

1. Select the Peek Return Value row in the block's property table.
2. In the Value field, select CurrNumberWaitingCalls or ExpectedWaitTime from the drop-down list.

Configuring GetStatReq/PeakStatReq Requests

To get GetStatReq/PeakStatReq requests to work

Configure I-Server as follows:

1. In the I-Server Options tab, create the following section: Stat:ExpectedWaitTime
2. Under that section, create the following options/values:
 - obj_id = dn@switch (DN is the DNIS/Routing Point being called. The switch used is that to which SIP Server is associated in case of behind the switch and the Virtual switch in case of in front of the switch. Example: 9020@CTI_Switch
 - obj_type = SObjectQueue
 - server_name = stat_server_name (The name of the Stat Server object in the Configuration Database).
 - stat_type = ExpectedWaitTime
 - update_frequency = 5

Configure Stat Server as follows:

1. In the Stat Server options tab, create the following section: ExpectedWaitTime
2. Under that section, create the following options/values:
 - Category = ExpectedWaitTime
 - MainMask = CallWait
 - Objects = Queue
 - Subject = DNAction
3. Connect applications as follows:
 - T-Server IVR – Message Server
 - Ixn-Server – T-Server_IVR, Stat Server
 - URS – T-Server_IVR, Stat Server, Message Server
 - Stat Server – T-Server_IVR, Message Server

Output Result Property

You must use the Output Result property to assign the collected data to a user-defined **variable** for further processing.

Note! This property is mandatory. You must select a variable for the output result even if you do not plan on using the variable. If this is not done, a validation error will be generated in the Problems view.

1. Select the Output Result row in the block's property table.
2. In the Value field, click the down arrow and select a variable.

For more information, see [Upgrading Projects/Diagrams](#).

Condition Property

Find this property's details under [CommonPropertiesforCallflowBlocks](#).

Logging Details Property

Find this property's details under [CommonPropertiesforCallflowBlocks](#).

Log Level Property

Find this property's details under [CommonPropertiesforCallflowBlocks](#) .

Enable Status Property

Find this property's details under [CommonPropertiesforCallflowBlocks](#).

ICM Interaction Data Block

ICM refers to a Cisco product called Intelligent Contact Management, which provides intelligent routing and Computer Telephony Integration. You can use the GVP ICM Adapter in VoiceXML applications when invoking services, responding to requests, and sharing data. Use this block to send interaction data to ICM. It functions the same way as the existing [Interaction Data block](#). Composer uses the VXML <gvp:send> tag to implement the ICM Interaction Data functionality.

ICM Variables

Voice Projects have a [Project-level flag \(Enable ICM\)](#) which controls whether ICM variables are available for selection and assignment to variables within Composer's [Entry block](#). The Exit block's [Return Values](#) property dialog allows you to select the ICM variables to be returned. You can also set the Enable ICM flag by right-clicking the Project in the Project Explorer, selecting **Properties**, and **ICM Support**. The types of variables supported by ICM are:

- CED--This is a single variable with the name ICM_CED. It is automatically added to the variables list in the Entry block.
- Call variables--There are 10 CallVars, with names ICM_CallVar1 through ICM_CallVar10. They are automatically added to the variables list in the Entry block.
- ECC variables--These are user-named variables, which are identified by having a prefix of ICM_ECC_user; for example, ICM_ECC_userMyVariable. In the [Application Variables dialog](#), you can enter the names of the variables with or without the prefix. Composer provides a mechanism to automatically add the prefix.

Note: In all cases, the Enable ICM flag must be set for ICM variables to be selectable in the Entry block. The ICM Interaction Data block has the following properties:

Name Property

Find this property's details under [Common Properties](#).

Block Notes Property

Can be used for both callflow and workflow blocks to add comments.

Exceptions Property

Find this property's details under [Common Properties](#). The ICM Interaction Data block has the

following **exception events**:

- error.com.genesyslab.composer.receiveerror
- error.com.genesyslab.composer.operationtimeout
- error.com.genesyslab.composer.unsupported (pre-selected as a default exception)
- error.com.genesyslab.composer.invalidkey

Values Property

The Values property holds the list of variables to be fetched or sent. The name of the variable must match the UserData key name. To select values:

1. Click the Values row in the block's property table.
2. Click the  button to open the Values dialog box.
3. Select individual global **variables**, or click Select all or Deselect all.
4. Click OK.

Condition Property

Find this property's details under [Common Properties for Callflow Blocks](#) or [Common Properties for Workflow Blocks](#).

Logging Details Property

Find this property's details under [Common Properties for Callflow Blocks](#) or [Common Properties for Workflow Blocks](#).

Log Level Property

Find this property's details under [Common Properties for Callflow Blocks](#) or [Common Properties for Workflow Blocks](#).

Enable Status Property

Find this property's details under [Common Properties for Callflow Blocks](#) or [Common Properties for Workflow Blocks](#).

ICM Route Request Block

ICM refers to a Cisco product called Intelligent Contact Management, which provides intelligent routing and Computer Telephony Integration (CTI). You can use the GVP ICM Adapter in VoiceXML applications when invoking services, responding to requests, and sharing data. Use the ICM Route Request block to transfer a call to ICM. Note: This block functions in the same way as the existing [Route Request block](#). Composer uses the VXML <transfer> tag to implement the ICM Route Request functionality.

- For information on ICM Support and variables, see the figure in topic [Project Properties dialog box](#).

The ICM Route Request block has the following properties:

Name Property

Find this property's details under [Common Properties](#).

Block Notes Property

Can be used for both callflow and workflow blocks to add comments.

Exceptions Property

Find this property's details under [Common Properties](#). The following events are supported:

- connection.disconnect.hangup
- connection.disconnect.transfer
- error
- error.connection.noauthorization
- error.connection.baddestination
- error.connection.noresource
- error.connection.noroute
- error.connection
- error.unsupported.transfer.blind
- error.unsupported.transfer.consultation
- error.unsupported.uri

- error.com.genesyslab.composer.unsupported

Custom events are also supported.

Interaction Data Property

To select session variables:

1. Click the Interaction Data row in the block's property table.
2. Click the  button to open the Interaction Data dialog box.
3. Select individual global variables, or click Select all or Deselect all.
4. Click OK.

Output Result Property

You must use the Output Result property to assign the collected data to a user-defined variable for further processing. Note! This property is mandatory. You must select a variable for the output result even if you do not plan on using the variable. If this is not done, a validation error will be generated in the Problems view.

1. Select the Output Result row in the block's property table.
2. In the Value field, click the down arrow and select a variable.

Aai Property

Use the optional Application-to-Application Information (the Aai property) for the data that is to be transferred from the current application to another application. Use this option to transfer the call to a number that initiates another voice application. To assign a value to the Aai property:

1. Select the Aai row in the block's property table.
2. In the Value field, select a value from the drop-down list.

Values are the Voice Application Variables described under the Variables Property.

Transfer Audio Property

The optional Transfer Audio property plays a prompt to the end user while the number is being dialed out. You provide the URI of the audio source to play while the transfer attempt is in progress (before the other end answers). If the callee answers, the interpreter terminates playback of the recorded

audio immediately. If the end of the audio file is reached and the callee has not yet answered, the interpreter plays the audio tones from the far end of the call (ringing, busy). If the resource cannot be fetched, the error is ignored and the transfer continues. To provide a Transfer Audio value:

1. Select the Transfer Audio row in the block's property table.
2. In the Value field, type a Transfer Audio value URI (HTTP or RTSP) specifying the location of the audio file to play.

Connect Timeout Property

Use the Connect Timeout property for the connection timeout value. The default is 30 seconds. To provide a timeout value:

1. Select the Connect Timeout row in the block's property table.
2. In the Value field, type a timeout value, in seconds.

Connect When Property

This property controls whether the connection is made after the call is picked up, or immediately. Select one of the following:

- Immediate
- Answered

Destination Property

The Destination property contains the destination phone number. The destination number can be one of the following:

- A Virtual Route point number on which the IRD Strategy is loaded
- Extension number of an Agent
- External number

The value must be specified in one of the formats below:

- sip:[user@]host[:port]
- tel:phonenumber e.g., tel:+358-555-1234567

For information on this property, select Help > Contents and see the GVP 8.1Voice XML 2.1 Reference Help. Specifically see Standard VoiceXML > Variables > Transfer, attribute dest. To assign a value to the Destination property:

1. Select the Destination row in the block's property table.
2. In the Value field, select a value from the drop-down list.

Values are the Voice Application **Variables** described in the Entry block.

Max Call Duration Property

Use the Max Call Duration property for the maximum call duration. Default value is 0. This property is not supported for Consultation and Blind transfer types. Note: If this is set to 0 (zero), an infinite value is supplied, and there is no upper limit to the call duration. To provide a value for the maximum call duration:

1. Select the Max Call Duration row in the block's property table.
2. In the Value field, type a value for the maximum call duration.

Transfer Type Property

The Transfer Type property specifies the type of transfer required. To assign a value to the Transfer Type property:

1. Select the Transfer Type row in the block's property table.
2. In the Value field, select one of the following from the drop-down list:

Blind

This is the default setting. The platform redirects the caller to the agent without remaining in the connection, and it does not monitor the outcome. Once the caller is handed off to the network, the caller's session with the VoiceXML application cannot be resumed. The VoiceXML interpreter throws a `connection.disconnect.transfer` immediately, regardless of whether the transfer was successful or not.

Bridge

The platform adds the agent to the connection. Document interpretation suspends until the transferred call terminates. The platform remains in the connection for the duration of the transferred call; listening during transfer is controlled by any included `<grammar>s`. If the caller disconnects by going onhook or if the network disconnects the caller, the platform throws a `connection.disconnect.hangup` event. If the agent disconnects, then transfer outcome is set to `near_end_disconnect` and the original caller resumes her session with the VoiceXML application.

Consultation

The consultation transfer is similar to a blind transfer except that the outcome of the transfer call setup is known and the caller is not dropped as a result of an unsuccessful transfer attempt. When performing a consultation transfer, the platform monitors the progress of the transfer until the

connection is established between caller and agent. If the connection cannot be established (e.g. no answer, line busy, etc.), the session remains active and returns control to the application. As in the case of a blind transfer, if the connection is established, the interpreter disconnects from the session, `connection.disconnect.transfer` is thrown, and document interpretation continues normally. Any connection between the caller and the agent remains in place regardless of document execution. Note: The selected transfer type will work only if the platform is provisioned to support that type of transfer.

Method Property

The Method property specifies the type of route request required. To assign a value to the Method property:

1. Select the Method row in the block's property table.
2. In the Value field, select one of the following from the drop-down list:

Bridge

A Bridge method indicates that the Media Control Platform (MCP) bridges the media path.

1. The platform sends an INVITE request to the callee, and a dialog is established between the callee and the platform.
2. The transfer fails if a non-2xx final response is received for the INVITE request.

This is a two-leg transfer (in other words, it occupies two channels on the platform). The platform stays in the signaling path and is responsible for bridging the two call legs.

Hkf (Hookflash)

A Hookflash method indicates a transfer using DTMF digits (RFC 2833).

1. The Media Control Platform (MCP) sends DTMF digits on the media channel. The platform leaves it to the media gateway or switch to perform the transfer on the network.
2. Configurable options enable you to specify whether the call will be disconnected by the platform or by the remote end. Otherwise, the call is disconnected after a configured timeout.

This is a one-leg transfer (in other words, it occupies only one channel on the platform).

Refer

A Refer method indicates that the transfer is based on a SIP REFER message (RFC 3515).

1. The platform sends a REFER request to the caller, with the callee (as specified in the VoiceXML application) in the Refer-To: header.
2. The transfer fails if a non-2xx final response is received for the REFER.

This is a one-leg transfer (in other words, it occupies only one channel on the platform).

Referjoin

A Referjoin method indicates a consultative REFER transfer (RFC 3891).

1. The platform sends an INVITE request to the callee, and a dialog is established between the callee and the platform.
2. The platform also sends a REFER request to the caller, with the callee's information in the Replaces header.
3. The platform considers the transfer to be successful if it receives a BYE from the caller after a 2xx response for the REFER.
4. The transfer fails if a non-2xx final response is received for the INVITE request or for the REFER request.

This is a two-leg, or join-style, transfer (in other words, it occupies two channels on the platform).

Mediaredirect

A Mediaredirect method indicates a media redirection transfer. The Media Control Platform (MCP) uses SIP to handle call control between the caller and the callee, and the RTP media channel is connected directly between the caller and callee.

1. The platform sends an INVITE request to the callee without SDP.
2. If the transfer is proceeding, the callee responds with a 200 OK that includes an SDP offer.
3. The platform forwards the SDP offer in a re-INVITE request to the caller.
4. The caller responds with a 200 OK that includes the SDP answer.
5. The platform forwards the SDP answer to the callee in an ACK response.
6. The transfer fails if a non-2xx final response is received for the initial INVITE request.

This is a two-leg transfer (in other words, it occupies two channels on the platform). `attcourtesy`, `attconsult`, `attconference`, `attoobcourtesy`, `attoobconsult`, and `attoobconference` For information on these methods, consult the section on how the Media Control Platform works in the *Genesys Voice Platform 8.1 Deployment Guide*.

Do CPA Analysis Property

Triggers whether the platform will detect who or what answered the call. Select one of the following:

- True
- False (default, no detection)

Get Shadow Variables Property

Shadow variables provide a way to retrieve further information regarding the value of an input item. By setting this property to true, it will expose the block's shadow variable within the callflow. When enabled, the shadow variable will be included in the list of available variables. (For example, the **Log block's** Logging Details will show RouteRequest1\$.) A shadow variable is referenced as blockname\$.shadowVariable, where blockname is the value of the input item's name attribute, and shadowVariable is the name of a specific shadow variable, for example: RouteRequest1\$.duration. To assign a value to the Get Shadow Variables property:

1. Select the Get Shadow Variables row in the block's property table.
2. In the Value field, select true or false from the drop-down list.

Transfer Result Property

To select transfer results:

1. Click the Transfer Results row in the block's property table.
2. Click the  button to open the Transfer Results dialog box.
3. Select items from the list of available CPA results, or click Select all or Deselect all as needed, then click OK.

For each item selected, an output node is added to allow specific actions to be taken for that condition.

Input Grammar Dtmf Property

Use the Input Grammar Dtmf property to specify the DTMF Grammar for the Input Block. The DTMF Grammar is processed and handled by GVP. In the case of external grammars, this specifies the actual path of the grammar file / resource for DTMF Grammars. This is only valid when the Grammar Type is externalGrammar and Input Mode is dtmf or hybrid. To assign a value to the Input Grammar Dtmf property:

1. Select the Input Grammar Dtmf row in the block's property table.
2. In the Value field, select a value from the drop-down list.

Values are the Voice Application Variables described under the Variables Property.

Input Grammar Voice Property

Use the Input Grammar Voice property to specify the Voice Grammar for the Input block. If you are writing hybrid applications that allow both DTMF and Speech input, specify both the DTMF and Voice

grammars. The Voice Grammar is sent to the ASR Engine for processing, whereas the DTMF grammar is processed by GVP. As a result, you need two separate grammars for Voice and DTMF in the case of hybrid applications that allow both Voice and DTMF inputs. In the case of external grammars, this specifies the actual path of the grammar file / resource for ASR Grammars.. This is only valid when Grammar Type is externalGrammar and Input Mode is voice or hybrid. To assign a value to the Input Grammar Voice property:

1. Select the Input Grammar Voice row in the block's property table.
2. In the Value field, select a value from the drop-down list.

Values are the Voice Application Variables described under the Variables Property.

Input Mode Property

To assign a value to the Input Mode property:

1. Select the Input Mode row in the block's property table.
2. In the Value field, select one of the following from the drop-down list:

DTMF

The DTMF format indicates the menu option mode of input will be via the telephone keypad.

Voice

The Voice format indicates the menu option mode of input will be a voice phrase.

Hybrid

The Hybrid menu mode will handle both DTMF and Voice inputs, that is via telephone keypad and voice phrase.

Condition Property

Find this property's details under [Common Properties for Callflow Blocks](#) or [Common Properties for Workflow Blocks](#).

Logging Details Property

Find this property's details under [Common Properties for Callflow Blocks](#) or [Common Properties for Workflow Blocks](#).

Log Level Property

Find this property's details under [Common Properties for Callflow Blocks](#) or [Common Properties for Workflow Blocks](#).

Enable Status Property

Find this property's details under [Common Properties for Callflow Blocks](#) or [Common Properties for Workflow Blocks](#).

Working with CTI Applications

Composer provides **CTI blocks** for two CTI scenarios supported by GVP:

- SIP Server (SIPS) scenario, which uses the Genesys SIP Server component to gain access to CTI functionality.
- CTI Connector (CTIC) scenario, which uses GVP's CTI Connector component to access CTI functionality provided by Genesys Framework.

These two scenarios do not provide identical capabilities and key differences are highlighted later in these topics. Composer provides four CTI blocks for accessing CTI functions. It generates VXML for each of these blocks that can work in either CTI scenario (SIPS or CTIC), and does not ask the user to choose between the SIPS or CTIC scenarios at design time. The decision to use CTIC or SIPS is made at runtime based on the X-Genesys headers received from GVP's Resource Manager. Therefore, the Composer user interface does not need to expose a Project-level preference for specifying the CTI scenario. **Note:** The CTI Connector provides different capabilities depending on the configuration in which other Genesys components like the IServer are deployed. For more details, please refer to the GVP documentation. Also see [GVP Debugging Limitations](#).

Design Paradigms for CTI Applications

There are two design paradigms for building CTI applications with GVP in which Composer can be used:

- Standard VXML Applications
- URS-Centric Applications

These paradigms differ in the extent to which the VXML application is involved in performing call control. **Standard VXML Applications** In this paradigm, the VXML application gets invoked first and can go through VXML interactions with the caller before using the <transfer> tag to transfer the call to another party such as queuing for an agent. At this point, the control of the call is passed to the SIP Server or CTI Connector while waiting for an agent. During this time, SIP Server or CTI Connector may invoke additional call treatments on GVP like playing music or invoking other applications. **URS-Centric Applications** In this paradigm, the VXML application is always invoked as a treatment by Genesys URS. The incoming call is controlled by Genesys URS and a strategy retains full control of the call. The strategy invokes specific treatments on GVP IVR as a media server to play prompts, play music, collect user input or execute a VXML application. In this paradigm, the VXML application does not use tags like <transfer> nor does any other kind of call control. Those decisions are left to the strategy. The VXML application returns user input collected during the call back to the strategy and lets the strategy make all call control decisions. Composer can be used to write VXML applications following either of the above paradigms.

Typical CTI Callflow

Before you start building a typical CTI application, the following information is required:

- The Genesys Virtual Route Point destination address. This is the address/location where the Genesys strategy is present (an integer number--for example, 5001).
- Strategy application on the Framework side (IRD) to find and transfers the call to an agent.

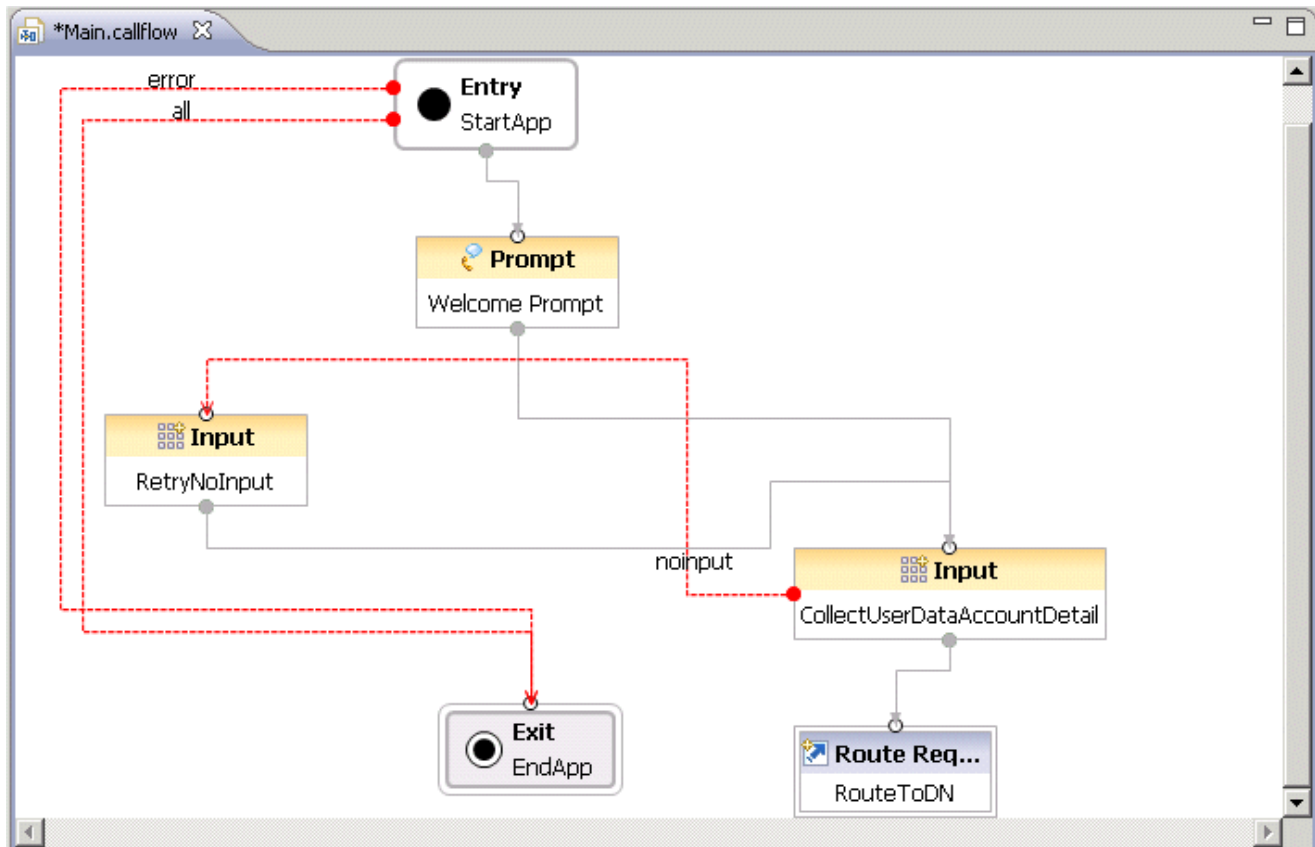

The following describes the interaction flow of this callflow:

1. GVP starts executing the generated VoiceXML application script.
2. The caller hears the Welcome prompt.
3. The caller is requested to enter the account details.
4. If the caller does not enter the required details within the maximum time frame provided, the caller is asked to retry.
5. The application issues a route request to the route DN configured in the **Route Request** block. (This occurs via the <transfer> tag, supported in both CTIC and SIP Server scenarios.)
6. The caller-entered data is sent as UserData to the routed DN, and the called strategy does the knowledge based transfer to the available agent based on the User Data .

7. This application ends after the Route Request has been issued.
8. The called strategy can play Voice treatments to the caller until the next available agent is available.
9. Finally, the caller will be transferred to the Agent.

Note: The **Route Request** block can be configured in various Transfer modes (Bridge / Consultation) to gain back the control of the callflow after the called strategy returns back the execution. Please check the Route Request topic block for more details.

CTI Scenarios

There are feature differences between the SIPS and CTIC scenarios. The following table gives a summary of the **CTI blocks**, and for each CTI block it lists the differences in behavior for the two CTI scenarios.

CTI Block Name	Supports CTIC Case?	Supports SIPS Case?	Comments
Interaction Data Block	Yes	Yes	<p>Supported operations in each scenario:</p> <p>CTIC:</p> <ul style="list-style-type: none"> • PUT • GET • DELETE • DELETEALL • REPLACE <p>SIPS:</p> <ul style="list-style-type: none"> • PUT • GET <p>Types of interaction data supported: CTIC:</p> <ul style="list-style-type: none"> • USERDATA <p>SIPS:</p> <ul style="list-style-type: none"> • USERDATA
Get Access Number Block	Yes	No	<p>Get access number block can only be used in the CTIC scenario.</p> <p>Types of interaction data supported: CTIC:</p> <ul style="list-style-type: none"> • USERDATA • EXTENSIONDATA

Statistics Block	Yes	No	Statistics block can only be used in the CTIC scenario.
Route Request Block	Yes	Yes	Types of interaction data supported: CTIC: <ul style="list-style-type: none"> USERDATA EXTENSIONDATA SIPS: <ul style="list-style-type: none"> USERDATA Types of transfers supported: CTIC: <ul style="list-style-type: none"> Blind Bridge SIPS: <ul style="list-style-type: none"> Consultation Blind bridge

In case a CTI block or feature is used in a CTI scenario in which it is not supported, appropriate exceptions will be thrown at runtime indicating that the feature is not supported. The table below gives a list of all exceptions that can be thrown by CTI blocks and other possible CTI-related exceptions that can be thrown if errors are encountered at runtime.

Block(s)	Exception	Error Message	Description
Interaction Data Block Get Access Number Block, Statistics Block	error.com.genesyslab.composer.InvalidKey	Missing <block name> key <key name>	This is the event error for handling an invalid key name.
Interaction Data Block Get Access Number Block Statistics Block, Route Request Block	error.com.genesyslab.composer.OperationTimeout	Operation timed out	This exception will be thrown when a <receive> operation, executed in the context of a CTIC specific operation, times out.
Interaction Data Block Get Access Number Block Statistics Block Route Request Block	error.com.genesyslab.composer.receiveError	<Error string returned by CTIC>	If the <receive> fails and an error is reported by CTIC, this exception will be thrown.
Interaction Data Block	error.com.genesyslab.composer.UnsupportedOperation	Delete operation not supported in case of CTI using SIPServer.	If the user wants to do a userdata DELETE in the CTI using SIPS scenario.
Interaction Data Block	error.com.genesyslab.composer.UnsupportedOperation	Delete As operation not	If the user wants to do a

		supported in case of CTI using SIPServer.	userdata DELETEALL in the CTI using SIPS scenario.
Interaction Data Block	error.com.genesyslab.composer.unsupported	Replace operation not supported in case of CTI using SIPServer.	If the user wants to do a userdata REPLACE in the CTI using SIPS scenario.
Get Access Number Block	error.com.genesyslab.composer.unsupported	AccessNumGet operation not supported in case of CTI using SIPServer.	If the user wants to do a AccessNumGet in the CTI using SIPS scenario.
Statistics Block	error.com.genesyslab.composer.unsupported	Statistics block not supported in case of CTI using SIPServer.	If the user wants to do a PeekStatReq or GetStatReq in the CTI using SIPS scenario.
Route Request Block	error.com.genesyslab.composer.unsupported	Consultation transfer is not supported in case of CTI using CTIConnector.	If user sets Transfer type to consultation in case of CTI using SIPS.

Script ID Usage in the GVP 8 Environment

In Genesys VoiceXML 2.1, ScriptId refers to the script identifier, as generated by the CTI Connector, to handle call treatments. The use of ScriptId is specific to GVP 7.x and was mandatory for treatments. Since the GVP 7.x design is "IVR-centric," the treatment would be invoked on the same VXML session. Things are a bit different with GVP 8.x and the Next Generation Interpreter (NGI) where APP_URI is used instead of ScriptId and the treatments are executed on different VXML sessions. **GVP 8 and NGI** In GVP 8.x, request for treatment execution comes in as a NETANN request with the APP_URI being passed in as a VoiceXML parameter. GVP executes the requested page to kick off the treatment. Unlike the GVP 7.x environment, treatments get invoked as separate VXML sessions and terminated at the end of the treatment execution. Hence, ScriptId switching is no longer needed here, unless an application wants to do branching based on ScriptId.

- Note: Composer provides support for both SIPS and CTIC scenarios for achieving the CTI functionality. However, SIPS may not support passing additional request-uri parameters like ScriptId, therefore, this option is limited only to CTIC scenarios.

Please refer to *GVP 8.x VXML Help* under Sample Voice XML Applications > CTI Interactions > Treatments for more details on this topic.

Accessing ScriptId in Composer

Use if you want your application to do ScriptId-based switching like GVP 7.x. **CTIC Scenario (IRD strategy + Composer Callflow)**

1. Use the APP_ID property in IRD's Play Application block.
2. Define a new **Input** type variable named ScriptId in the Entry block of your callflow to collect the ScriptId.

Composer Workflow + Composer Callflow)

1. On the VXML callflow side, define a new **Input** type variable named ScriptId in the Entry block to collect the APP_ID (i.e., ScriptId) passed from the workflow.
2. On the SCXML workflow side, use the **Play Application** block to invoke the callflow created using step#1. Then do an auto-synchronize for the parameters, and specify the ScriptId value.
3. The ScriptId (i.e., APP_ID) passed from the workflow will be automatically collected on the VXML side from the `session.connection.protocol.sip.requesturi` array.

SIPS Scenario

1. SIPS may not support passing additional request-uri parameters. Pass ScriptId as attached data on the strategy side (If using IRD) or on the SCXML side (If using Composer workflows).
2. Define a new **Input** type variable named ScriptId in the Entry block to collect the ScriptId.
3. The ScriptId (i.e., APP_ID) passed from the strategy will be automatically collected on the VXML side from the `session.com.genesyslab.userdata` array.

Voice External Message Blocks

The External Messaging palette provides blocks for NGI extensions to send and receive external messages to/from external entities such as CCXML applications. There are four External Message blocks:

- **Receive Block** for receiving synchronous and asynchronous SIP INFO messages. This is can be used to receive messages from CCXML applications.
- **Send Data Block**, which is a wrapper around the <send namelist> tag) for sending a list of variables as SIP INFO to the other end point. The data is sent in the form-url-encoded format, in the BODY of the SIP INFO.
- **Send Info Block** generates the NGI VXML <send body> tag for sending any content in the Body of the SIP INFO. By default, content-type is set to text/plain. Typically, this can be used in conjunction will CCXML applications.
- **Send Event Block** generates the NGI VXML <send event> tag to send SIP INFO events or custom events between the VXML dialog and the CCXML application.

For all the Send [xxx] blocks, you have the option to specify the Wait for response property as true in those blocks to send the message synchronously.

Receive Block

Use the Receive block for receiving synchronous and asynchronous SIP INFO messages. This is can be used to receive messages from CCXML applications.

A typical use case is for a CCXML application to interrupt the VXML dialog in order to take some action.

Depending upon how the data is sent, the content, content-type or event properties will be filled.

The Receive block has the following properties:

The Receive block has no page exceptions.

Name Property

Find this property's details under [Name_Property](#).

Block Notes Property

Can be used for both callflow and workflow blocks to add comments.

Content Property

The Content property is the variable used to collect the content of the received event.

To select a variable:

1. Select the Content row in the block's property table.
2. In the Value field, select one of the available [variables](#) from the drop-down list.

Content Type Property

The Content Type property is the variable used to collect the content type of the received event.

To select a variable:

1. Select the Content Type row in the block's property table.
 2. In the Value field, select one of the available [variables](#) from the drop-down list.
-

By default, Content Type is set to text/plain.

Event Name Property

The Event Name property is the variable used to collect the name of the received event.

To select a variable:

1. Select the Event Name row in the block's property table.
2. In the Value field, select one of the available **variables** from the drop-down list.

Condition Property

Find this property's details under [Common Properties for Callflow Blocks](#).

Logging Details Property

Find this property's details under [Common Properties for Callflow Blocks](#).

Log Level Property

Find this property's details under [Common Properties for Callflow Blocks](#).

Enable Status Property

Find this property's details under [Common Properties for Callflow Blocks](#).

Send Data Block

Use the Send Data block (a wrapper around the `<send namelist>` tag) for sending a list of variables as SIP INFO to the other end point. The data is sent in the form-url-encoded format, in the BODY of the SIP INFO.

Typically, Send Data can be used by VXML applications to send data to a CCXML application or to CTI applications.

For example, CCXML use cases that use Composer External Messaging Blocks (such as Send Data, Send Info, and Send Event), see the *Genesys Voice Platform 8.1 CCXML Reference Manual*. See the Features chapter, Dialogs section.

When using either the Send Data or Send Info block, the result on the CCXML side is to create a `dialog.user.*` event. The name of the event is set to `dialog.<event name>`.

Dialog User Event Example

The VoiceXML dialog may send a user event to the CCXML application by using the `<send namelist="name type uri"/>` tag. Here is an example of the VoiceXML `<send>` block:

```
<var name="name" expr="'transfer'"/>
<var name="type" expr="'bridge'"/>
<var name="uri" expr="'1111@205.150.90.19'"/>
<gvp:send namelist="name type uri"/>
```

The CCXML session receives the following:

```
15:02:04.416 Int 51030 F9187A00-E558-44C6-61AE-FFA9A066180C-FF326086-ECB5 dlg_event
7|dialog.user.transfer|DD92E8B2-51AD-4F3F-8C8D-
40AFA169EA9B|values.name="transfer";values.type="bridge";values.uri="1111@205.150.90
.19
```

This raises a `dialog.user.transfer` event to the CCXML application that owns the dialog. The event itself contains the following properties:

```
event$.values.name=transfer
event$.values.type=bridge
event$.values.uri=1111@205.150.90.19
```

Note: The `event$` is a generic name for CCXML events, and in the preceding example, it is

dialog.user.transfer. The contenttype attribute is not supported by the <send> tag if the namelist is used.

The Send Data block has the following properties:

The Send Data block has no page exceptions.

Name Property

Find this property's details under [Common Properties](#).

Block Notes Property

Can be used for both callflow and workflow blocks to add comments.

Values Property

The Values property holds the list of variables to be sent.

To select values:

1. Click the Values row in the block's property table.
2. Click the  button to open the **Values** dialog box.
3. Select individual variables, or click **Select all** or **Deselect all**.
4. Click **OK**.

Wait For Response Property

The Wait For Response property allows a message to be sent synchronously (when set to true). By default, data is sent asynchronously for all the Send [xxx] blocks (when this property is set to false).

To assign a value to the Wait For Response property:

1. Select the **Wait For Response** row in the block's property table.
2. In the **Value** field, select true or false from the drop-down list.

Condition Property

Find this property's details under [CommonPropertiesforCallflowBlocks](#).

Logging Details Property

Find this property's details under [CommonPropertiesforCallflowBlocks](#).

Log Level Property

Find this property's details under [CommonPropertiesforCallflowBlocks](#).

Enable Status Property

Find this property's details under [CommonPropertiesforCallflowBlocks](#).

Send Event Block

Use the Send Event block, which generates the NGI VXML <send event> tag, to send SIP INFO events or custom events between the VXML dialog and the CCXML application. Examples: logging events or any event specific to the dialog and the CCXML application. For more information, see the *Genesys Voice Platform 8.1 CCXML Reference Manual, Event/IO Processor, Sending Events*.

The Send Event block has the following properties:

The Send Event block has no page exceptions.

Name Property

Find this property's details under [Common Properties](#).

Block Notes Property

Can be used for both callflow and workflow blocks to add comments.

Event Name Property

The Event Name property is the variable used to collect the name of the sent event.

To select a variable:

1. Select the Event Name row in the block's property table.
2. In the Value field, select one of the available [variables](#) from the drop-down list.

Wait For Response Property

The Wait For Response property allows a message to be sent synchronously (when set to true). By default, data is sent asynchronously for all the Send [xxx] blocks (when this property is set to false).

To assign a value to the Wait For Response property:

1. Select the **Wait For Response** row in the block's property table.
2. In the **Value** field, select true or false from the drop-down list.

Condition Property

Find this property's details under [CommonPropertiesforCallflowBlocks](#).

Logging Details Property

Find this property's details under [CommonPropertiesforCallflowBlocks](#).

Log Level Property

Find this property's details under [CommonPropertiesforCallflowBlocks](#).

Enable Status Property

Find this property's details under [CommonPropertiesforCallflowBlocks](#).

Send Info Block

Use the Send Info block, which generates the NGI VXML <send body> tag, for sending any content in the Body of the SIP INFO. By default, content-type is set to text/plain.

Typically, this can be used in conjunction with CCXML applications.

For example, CCXML use cases that use Composer External Messaging Blocks (such as Send Data, Send Info, and Send Event), see the *Genesys Voice Platform 8.1 CCXML Reference Manual*. See the Features chapter, Dialogs section.

When using either the Send Data or Send Info block, the result on the CCXML side is to create a dialog.user.* event. The name of the event is set to dialog.<event name>.

For an example, see the [Dialog User Event Example](#) in the Send Data block description.

The Send Info block has the following properties:

The Send Info block has no page exceptions.

Name Property

Find this property's details under [Common Properties for Callflow Blocks](#).

Block Notes Property

Can be used for both callflow and workflow blocks to add comments.

Content Property

The Content property is the variable used to collect the content of the sent event.

To select a variable:

1. Select the **Content** row in the block's property table.
2. In the **Value** field, select one of the available [variables](#) from the drop-down list.

Content Type Property

The Content Type property is the variable used to collect the content type of the sent event.

To select a variable:

1. Select the **Content Type** row in the block's property table.
2. In the **Value** field, select one of the available [variables](#) from the drop-down list.

By default, Content Type is set to text/plain.

Wait For Response Property

The Wait For Response property allows a message to be sent synchronously (when set to true). By default, data is sent asynchronously for all the Send [xxx] blocks (when this property is set to false).

To assign a value to the Wait For Response property:

1. Select the **Wait For Response** row in the block's property table.
2. In the **Value** field, select true or false from the drop-down list.

Condition Property

Find this property's details under [CommonPropertiesforCallflowBlocks](#).

Logging Details Property

Find this property's details under [CommonPropertiesforCallflowBlocks](#).

Log Level Property

Find this property's details under [CommonPropertiesforCallflowBlocks](#).

Enable Status Property

Find this property's details under [CommonPropertiesforCallflowBlocks](#).

Reporting Blocks

Reporting Blocks provide interfaces for GVP and Reporting Server whenever the application needs to perform Voice Application Reporting for IVR actions. There are four Reporting blocks:

- **Action Start Block** indicates the start of a Voice Application Report (VAR) transaction.
- **Action End Block** allows the application to indicate the end of a Voice Application Report (VAR) transaction.
- **Set Call Data Block** allows the application to report custom data for the call.
- **Set Call Result Block** allows the application to indicate the end of a call.

Action Start Block

The Action Start block indicates the start of a Voice Application Report (VAR) transaction. You can specify the Action Id and Parent Action for the action. Composer generates Subcallflow start and End events whenever a <SubDialog> (Subcallflow) got executed in the call. Composer-generated VXML code automatically generates the events. With this feature all the events (Main and Sub callflow events) generated for a call can be found with in a single umbrella in the Reporting server.

Sample report page in the Reporting server for an inbound IVR call with Custom IVR Action Start and End.

Instructions: VAR Events			
VAR Call Events - Filters: [Date-time: from 2008-11-20 00:00 to 2008-11-20 23:45]			
Call ID	Action	Start Time	Details
29CA0092-100060...	incall_begin	11/20/2008 06:27:00	112 sip:dialog@192.168.10.129:5070;voicexml=http://10.10.30.109:80
29CA0092-100060...	ivr_action_start	11/20/2008 06:27:01	CustomActionStart
29CA0092-100060...	ivr_action_end	11/20/2008 06:27:01	CustomActionStart UNKNOWN
29CA0092-100060...	incall_end	11/20/2008 06:27:01	aplend

The Action Start block has no page exceptions.

The Action Start block has the following properties:

Name Property

Find this property's details under [Common Properties](#).

Block Notes Property

Can be used for both callflow and workflow blocks to add comments.

Action Id Property

Note: The GVP 8 platform provides an extension to the <log> tag that allows application developers to indicate the start of an IVR Action The Action Id and Parent Action Id properties are used for this purpose. The syntax is as follows:

```
<log label="com.genesyslab.var.ActionStart">actionID[|parentID=<PID>]</log>
```

The Action Id property specifies a variable containing the name of the IVR action to report as being

started. The actionID is any valid UTF8 string that does not contain spaces or pipes, and is restricted to a maximum of 64 characters.

1. Select the Action Id row in the block's property table.
2. In the Value field, select one of the available [variables](#) from the drop-down list.

Parent Action Property

See Note in Action Id property description.

If an IVR action is to be nested inside some other active action, then the parent action's ID must also be included (PID). The Parent Action property specifies the variable used for the name of the parent action in which the new Action has to be contained.

1. Select the Parent Action row in the block's property table.
2. In the Value field, select one of the available [variables](#) from the drop-down list that contains the identifier for the Parent Action.

Important! If the Parent Action ID specified does not refer to an action that was already started, the Genesys Voice Platform Reporting Server will ignore the entire Action Start request.

Note: If the Parent Action ID specified does not refer to an action that was already started, the GVP Reporting Server will ignore the entire Action Start request.

Condition Property

Find this property's details under [CommonPropertiesforCallflowBlocks](#) or [CommonPropertiesforWorkflowBlocks](#).

Logging Details Property

Find this property's details under [CommonPropertiesforCallflowBlocks](#) or [CommonPropertiesforWorkflowBlocks](#).

Log Level Property

Find this property's details under [CommonPropertiesforCallflowBlocks](#) or [CommonPropertiesforWorkflowBlocks](#).

Enable Status Property

Find this property's details under [CommonPropertiesforCallflowBlocks](#) or [CommonPropertiesforWorkflowBlocks](#).

Action End Block

The Action End block allows the application to indicate the end of a Voice Application Report (VAR) transaction. You can specify the reason, results and notes corresponding to the action. Composer generates Subcallflow start and End events whenever a <SubDialog> (Subcallflow) got executed in the call. Composer-generated VXML code automatically generates the events. With this feature all the events (Main and Sub callflow events) generated for a call can be found with in a single umbrella in the Reporting server.

You are responsible for making sure to provide a valid Action Id name, for an action that was previously started in the application using the [Action Start](#) block.

By default an action end event will be sent by each terminating block of a callflow. This includes the [Exit](#) and [Disconnect](#) blocks.

The Action End block has no page exceptions.

The Action End block has the following properties:

Name Property

Find this property's details under [Common Properties](#).

Block Notes Property

Can be used for both callflow and workflow blocks to add comments.

Action Id Property

The Action Id property is the variable used in the [Action Start](#) block for the action to report as ended. It must be the same Action Id variable used in the Action Start block.

To select a variable:

1. Select the Action Id row in the block's property table.
2. In the Value field, select one of the available [variables](#) from the drop-down list.

Notes Property

The Notes property allows you to enter text (up to 4 KB of data) associated with the Action End event. Since Composer generates <log> labels for the Reporting blocks, text entered here can appear on voice application reports as described in the Genesys Voice Platform 8.1 User's Guide. See Provisioning GVP.

To enter notes:

1. Click the Notes row in the block's property table.
2. Click the  button to open the Notes dialog box.
3. Type text notes as needed and click OK.

Reason Property

The Reason property allows you to enter text for a reason for ending the action. The Reason field allows up to 4 KB of data. Note text appears on voice application reports.

To enter reason text:

1. Click the Reason row in the block's property table.
2. Click the dropdown arrow and select the variable that contains the reason text.

Result Property

The Result property contains the result of the action that was just ended.

To assign a value to the Result property:

1. Select the Result row in the block's property table.
2. In the Value field, select one of the following from the drop-down list:

UNKNOWN

The action had an unknown result.

SUCCESS

The action completed successfully.

FAILED

The action did not complete successfully (failed).

Condition Property

Find this property's details under [CommonPropertiesforCallflowBlocks](#) or [CommonPropertiesforWorkflowBlocks](#).

Logging Details Property

Find this property's details under [CommonPropertiesforCallflowBlocks](#) or [CommonPropertiesforWorkflowBlocks](#).

Log Level Property

Find this property's details under [CommonPropertiesforCallflowBlocks](#) or [CommonPropertiesforWorkflowBlocks](#).

Enable Status Property

Find this property's details under [CommonPropertiesforCallflowBlocks](#) or [CommonPropertiesforWorkflowBlocks](#).

Set Call Data Block

The Set Call Data block allows the application to report custom data for the call. You can select the list of variables to be reported. The name of the variable is used as the CustomData key. If eight keys are provided, the Reporting server will reject the data for any new keys received after that.

The Set Call Data block has no page exceptions.

The Set Call Data block has the following properties:

Name Property

Find this property's details under [Common Properties](#).

Block Notes Property

Can be used for both callflow and workflow blocks to add comments.

Variables Property

Use the Variables property to create custom variables. Variable content appears on GVP Voice Application reports (the VAR CDR Details Report). For more information, refer to the **Per-Call IVR Actions Report** section on page 367 in the *GVP 8.1 User Guide*. To create custom variables:

1. Click the **Variables** row in the block's property table.
2. Click under **Value** to add an entry to define application variables.
3. In the **Application Variables** dialog box, click **Add**.
4. In the **Variable Name** field, accept the default name or change it.
5. In the **Value** field, select a variable from the drop-down list.
6. In the **Description** field, type a description for this variable.
7. Click **Add** again to enter another parameter, or click **OK** to finish.

Delete Button

To delete a custom variable:

1. Select an entry from the list.

2. Click **Delete**.

Note: In version 8.1.300.xx, ignore the **Restore System Variables Default Values** button.

Condition Property

Find this property's details under [Common Properties for Callflow Blocks](#) or [Common Properties for Workflow Blocks](#).

Logging Details Property

Find this property's details under [Common Properties for Callflow Blocks](#) or [Common Properties for Workflow Blocks](#).

Log Level Property

Find this property's details under [Common Properties for Callflow Blocks](#) or [Common Properties for Workflow Blocks](#).

Enable Status Property

Find this property's details under [Common Properties for Callflow Blocks](#) or [Common Properties for Workflow Blocks](#).

Set Call Result Block

The Set Call Result block allows the application to indicate the end of a call. You can specify the reason, results and notes corresponding to the call result. In addition to tagging calls for Voice Application Reporting (VAR), you can also use this block for Service Quality Analysis (SQA) call status (success, failure) reporting. For information on SQA, see Genesys Voice Platform 8.1 Deployment Guide and Genesys Voice Platform 8.1 User's Guide.

The Set Call Result block has the following properties:

The Set Call Result block has no page exceptions.

Name Property

Find this property's details under [Common Properties](#).

Block Notes Property

Can be used for both callflow and workflow blocks to add comments.

Notes Property

The Notes property allows you to enter text (up to 4 KB of data) associated with the end of a call. Since Composer generates <log> labels for the Reporting blocks, text entered here can appear on voice application reports as described in the Genesys Voice Platform 8.1 User's Guide. See Provisioning GVP.

To enter notes:

1. Click the Notes row in the block's property table.
2. Click the  button to open the Notes dialog box.
3. Type text notes as needed and click OK.

Reason Property

The Reason property allows you to enter text for a reason for ending the call (maximum length of 256 characters).

To enter reason text:

1. Click the Reason row in the block's property table.
2. Click the dropdown arrow and select the variable that contains the reason text.

Result Property

The Result property contains the result of the call that was just ended.

To assign a value to the Result property:

1. Select the Result row in the block's property table.
2. In the Value field, select one of the following from the drop-down list:

UNKNOWN

SUCCESS

FAILED

UNKNOWN

The call had an unknown result.

SUCCESS

The call completed successfully.

FAILED

The call did not complete successfully (failed).

This property can be used for reporting both VAR metrics and SQA services as described above. Refer to Genesys Voice Portal documentation for information usage of this field for VAR (<log> label com.genesyslab.var.CallResult) and SQA (<log>label com.genesyslab.quality.failure).

Notes:

- Composer will not log SUCCESS and UNKNOWN call results, already available for VAR, to SQA.
- MCP will still log a call as a failure if it fails to meet one of the thresholds, even if the application never explicitly calls the <log> tag to indicate SQA failure.

Condition Property

Find this property's details under [CommonPropertiesforCallflowBlocks](#) or [CommonPropertiesforWorkflowBlocks](#).

Logging Details Property

Find this property's details under [CommonPropertiesforCallflowBlocks](#) or [CommonPropertiesforWorkflowBlocks](#).

Log Level Property

Find this property's details under [CommonPropertiesforCallflowBlocks](#) or [CommonPropertiesforWorkflowBlocks](#).

Enable Status Property

Find this property's details under [CommonPropertiesforCallflowBlocks](#) or [CommonPropertiesforWorkflowBlocks](#).

Genesys Voice Platform (GVP) Blocks

Starting with Composer 8.1.430.03, Composer supplies the following **GVP** block:

- **IVR Recording Block**

IVR Recording Block

Starting with 8.1.430.03 Composer supplies an IVR Recording block that allows you to control and record an IVR application from a Composer IVR self-service application. You can use this block to both record calls and to control the recording process by using additional blocks with START/STOP/PAUSE/RESUME operations for recording. Once the application executes, recording becomes available via [Genesys Interaction Recording \(GIR\)](#).

Important

The IVR Recording block works only with GIR and is not applicable to environments where third party recording solutions are integrated with GVP.

Prerequisites

The IVR Recording block requires the following Genesys components:

- SIP Server version 8.1.102.39
- GVP Resource Manager version 8.5.170.38
- GVP Media Control Platform version 8.5.170.71

This block has the following properties:

Name Property

Find this property's details under [Common Properties for Callflow Blocks](#),

Block Notes Property

Find this property's details under [Common Properties for Callflow Blocks](#).

Action Property

Record action to perform. Select one of the following: start, stop, pause, resume, or a variable.

Additional Commands Property

Use for additional commands for GIR. Click the open the Additional Commands dialog box. Select **Add** to open a dialog box where you can enter one or more key-value pairs using a literal or variable. If applicable, check the **Value is numeric** check box. For information on these commands, refer to the [Genesys Interaction Recording](#) documentation.

Exceptions Property

Find general information about this property under [Common Properties for Callflow Blocks](#). For more specific information on these events, see the [GVP 8.1 Legacy Genesys VoiceXML 2.1 Reference Manual](#).

The IVR Recording block has the following exception events:

- `error`
- `error.semantic`
- `error.noresource.recording`

Condition Property

Find this property's details under [Common Properties for Callflow Blocks](#).

Logging Details Property

Find this property's details under [Common Properties for Callflow Blocks](#).

Log Level Property

Find this property's details under [Common Properties for Callflow Blocks](#).

Partitions Property

Note: This property requires Media Control Platform version 8.5.170.71+.

Use to set different partitions for each IVR Recording segment. Select the variable that contains the list of partitions.

GIR provides access control for recording files to allow any recording files be only accessible for certain users in GIR. To enforce access control, each recording file is provided with a set of partitions. You can individually apply a partition for the IVR recording segments using the Partitions property. For example, Partitions = sales, support can be set to a recording segment using the IVR Recording block. Once this is applied, users from sales and support will only be able to access these particular recordings in GIR.

For more information, see the *Genesys Interaction Recording Solution Guide*, [Recording Methods](#).

Since GVP as an IVR does not support dynamic recording, to set the partition for an IVR segment, use GRECORD_PARTITIONS attached data and use full time recording for the IVR. Use dynamic recording for recording the agent segments.

Enable Status Property

Find this property's details under [Common Properties for Callflow Blocks](#) or [Common Properties for Workflow Blocks](#).

Note: The IVR Recording block does not support Debugger calls.

Using Voice Blocks

This section describes:

- [Common Properties for Callflow Blocks](#)
- [Working with Grammar Builder](#)
- [Working with CTI Applications](#)
- [Working with Prompts](#)
- [Working with Database Blocks](#)
- [User Data](#)
- [Connection Pooling](#)
- [Single Session Treatments](#)

Working with Grammar Builder

Grammar Builder provides a solution for supplying simple grammars, without requiring GRXML expertise. This editor provides a hierarchical view of certain grammar concepts in a simple, abstract way. Each level of this tree contains properties which affect all child members. Following is a brief description of the key concepts of the Grammar Builder model as well their relationship with GRXML.

Note: A Grammar built with the Grammar Builder is not a GRXML file.

Grammar

The grammar is the root object of the tree. It serves to provide an implicit description of the intended use of a grammar. For example, a grammar which would be used for a bank customer could be called bankmenuinput. The selection of a grammar name is determined by the file name or the related gbuilder file, and its setting influences the file name(s) of any exported GRXML data.

Within the grammar object are properties for the setting of languages. These languages, or locales, indicate support for a particular language. For each locale that is added to a grammar, a distinct GRXML file will be created specifically to support that language. DTMF, or touch-tone input, is considered a language even though it is not spoken.

Rule

Every grammar must contain at least one rule, but may contain many. Rules provide a grouping for a spoken (or DTMF) items. Continuing the bank customer scenario, we could have rules for yes/no responses, another for menu options and perhaps another for branch cities. Rules are the product that is referenced in a voice application.

At a point in an application where we wish to retrieve the branch city, we must refer to that grammar's rule. If an application designer does not specify a rule and instead only specifies the grammar file, the default rule is used. Additionally, a rule may be hidden from outside applications by declaring it as private. Usually this is for more sophisticated grammar cross-referencing, which is not currently supported in the more elementary Grammar Builder.

Keywords

Within a rule are specific keywords that will be used to add intelligence to an end application. Keywords become the value which can be identified within the application for use in branching or other application constructs. However, this keyword is independent of what may actually be spoken and is instead an internal identifier.

To bridge the gap between what a caller says or presses on their keypad, locale-specific synonyms are defined. Remember that the languages supported are defined at the grammar level. It is at this

point that those defined languages come into play. Each keyword will have a list of words (synonyms) which relate to the keyword for a given language.

For example, assuming as part of our yes/no rule, we have a keyword for yes. This keyword could contain the word yes for English, 1 for DTMF and oui for French. Regardless of which locale ends up being used in the running application, yes (the keyword identifier) will be returned.

Working with Grammars will guide you through the process of creating a simple grammar, using a user color selection problem as the example to model.

Using the Grammar Builder

Let's create a simple grammar for use with a project and the **Grammar Menu** block. Our example will be a user color selection problem. You will perform the following steps:

1. Create a new grammar builder file with initial settings.
2. Add keywords and synonyms for a rule.
3. Save the grammar builder file.
4. Export the grammar builder file to standard GRXML format.

Composer provides a cheat sheet for building a simple grammar file:

- Select **Help > Cheat Sheets > Composer > Building Voice Applications > Creating a simple grammar**.

Creating a New Grammar Builder File With Initial Settings

The first step is to create a new grammar builder file and provide its initial settings. Follow these steps:

1. Select **File > New > Other**.
2. From the New dialog box, expand the **Composer** folder, then expand the **Grammars** folder.
3. Select Grammar builder file and click **Next** to continue.
4. In the Container field of the wizard dialog box, click **Browse** to select a project-specific folder to contain the new .gbuilder file. Genesys recommends <voiceprojectname>/Resources/Grammars for the location.
5. Set the file name to use for this grammar. File names should give an indication of the context this grammar will be used in. For example, type colors.gbuilder in the File name field.

Note: The **Grammar Menu** block does not pick up changes automatically if you change your Gbuilder file. To synchronize the block with the latest changes, click on the **Gbuilder File** property of the Grammar Menu block. In the popup make sure that the correct **Gbuilder file** and **RuleID** are selected. Click **OK** to close the dialog. Your diagram will now reflect any menu options changes made in the Gbuilder file.

6. Next, set the initial default rule. Rules contain items which form a category. All grammar builder files must have at least one rule. Since our example grammar only deals with one such categorization, type **Colors** in the **Initial Default Rule** field.
7. *Locales* are languages that this grammar will support. By default, **English** and **digit input (DTMF)** are selected in the Initial locale(s) field. If you knew you would need to support additional languages for the grammar, you would select the appropriate check box(es). For our example, the default selections are adequate.

Note: Grammar Builder treats DTMF as a separate language (locale), even though technically it is not categorized as such.

8. After making the selections described above, click **Finish**.

The file is added to the selected project (as you can see in the Project Explorer), and the Grammar Builder opens as shown in the image below.

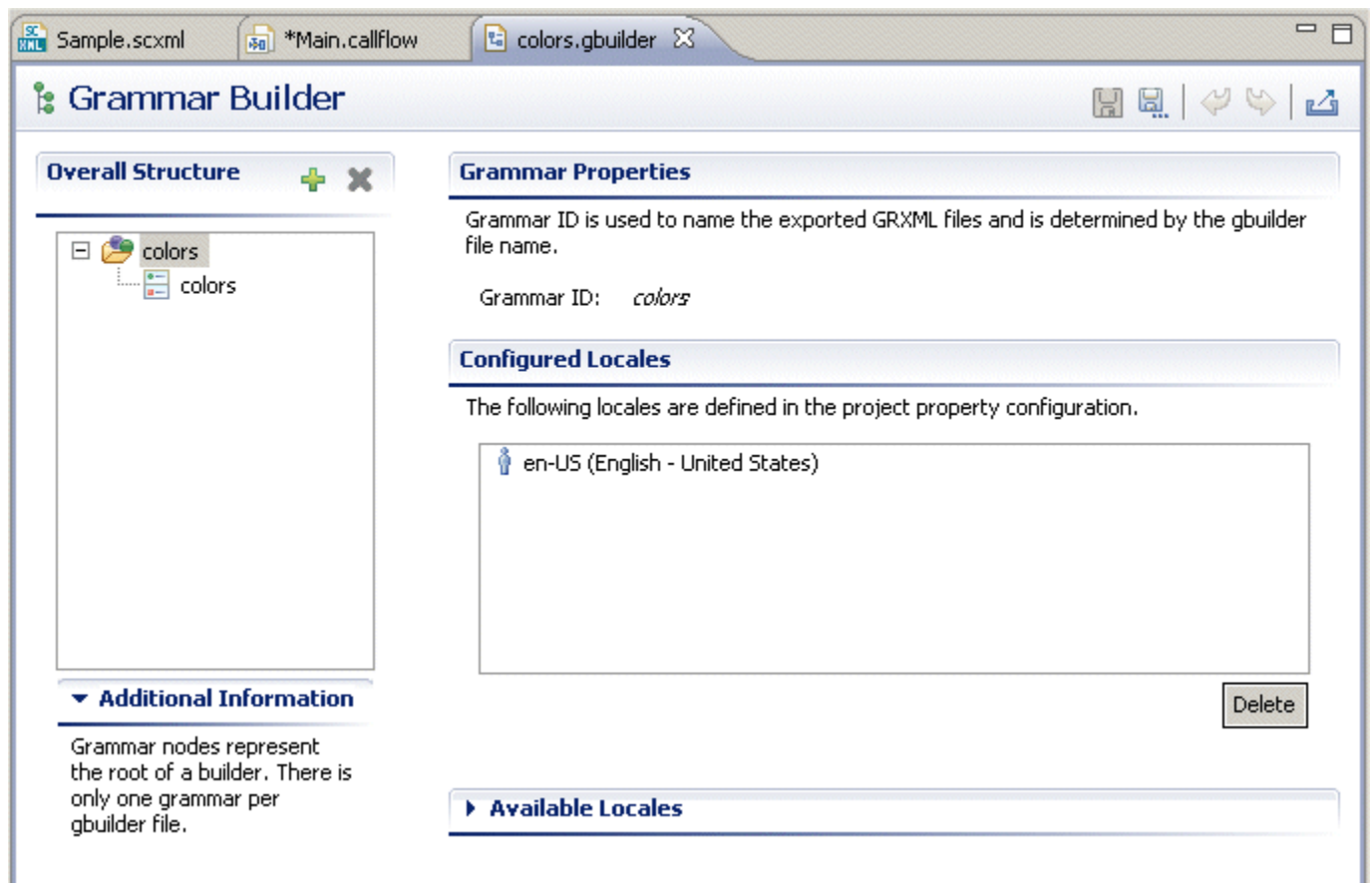

Adding Keywords and Synonyms for a Rule

Grammar builder files are created with a default rule. The next step is to define keywords for this rule. Each rule can have any number of input-agnostic keywords. These keywords will be returned

from either the speech or digit processor for use in your callflow.

By default, a keyword is not usable in an application. This is because multiple languages may use different words/sounds for your keyword. In our example, red may be an appropriate English pronunciation, but in Spanish this would not be true. Because of this, each configured locale must provide accepted input for the keyword. These inputs are called synonyms. Therefore, keywords consist of a logical identifier and a list of locale-specific synonyms.

Once you have defined keywords and synonyms for the default rule, you can then create additional rules and define keywords and synonyms for those rules as well.

To add a new keyword:

1. Select the **Colors** (default) rule in the **Overall Structure** tree.
 - The Rule Properties area shows the Public Visibility and Default Rule settings for the selected Rule ID.
 - **Default Rule.** This is selected only for the rule that has been set as the default (as is the Colors rule in this example).
 - **Note:** Not all aspects of Composer allow for specific rule targeting within grammar files (grxml). As such, it is highly recommended that you specify a default rule. This rule will be used by default when a reference to the grammar exists that does not target a specific rule. Considering that a default rule (e.g., root) is not mandatory in GRXML, no warning is given when one is not specified
 - **Public Visibility.** If selected, this indicates that this rule can be referenced by an external grammar (in a ruleref element in the grammar making the reference). A public rule can always be activated for recognition. If not selected, the rule is private, which indicates that the rule is visible only within its containing grammar. A private rule can be referenced by an external grammar if the rule is declared as the root rule of its containing grammar.
2. Click the  (**Add**) button.
3. In the Add new keyword dialog box, type a name for this keyword, which is normally an instance of the category that the rule defines. In our example, type **Red** in the **Keyword ID** field and click **OK**.
4. You can repeat the steps above to add more keywords to this rule.

To add a new synonym:

1. Select a keyword from the **Overall Structure** tree. In our example, select **Red**.

The Synonyms area allows you to add synonyms for each of the locales you have defined (each locale is a tab at the bottom of the synonyms table). Note in our example that the window has both English - United States and DTMF as bottom tabs. This allows you to switch the synonym context for the selected keyword.



1. With the English - United States tab selected, click **Add ID as Synonym**. This button allows you to add a synonym that is identical to the keyword, thus allowing red to be spoken in English and associated with the keyword **Red**.
2. You may at this time add other values, such as **Crimson** for example, which will also be accepted as Red.

3. Select the **DTMF** tab. To associate the digit 1 with the keyword Red, type 1 in the Digits field and click the Add button.
4. You can repeat the steps above to add more synonyms to this keyword.

Note: If you are using locales representing other languages, the synonyms you create for each locale would represent acceptable values for the keyword in that language. In our example, if you also defined Spanish and French locales, you could create a synonym rojo for the Red keyword in the Spanish locale, and a synonym rouge for the Red keyword in the French locale.

Saving the Grammar Builder File

When you have finished building your grammar builder file, or periodically during the course of building the file, be sure to save the changes you make to the file.

5. To save the file, click  (Save), or to save the file under a different name, click  (Save As) and provide a new file name and location.

Exporting the Grammar to GRXML Format

Because the Grammar Builder saves your grammar to a non-standard GRXML format (denoted with a .gbuilder extension on the file name), you will want to export the grammar to the standard GXML format as follows:

1. Click  (**Export**), located at the top-right corner of the Grammar Builder editor.
2. If prompted to save, click **Yes**.

You will see a message indicating the file has been successfully exported. The exported GRXML file names are displayed in the success window, and the .grxml file will display in the appropriate locale folder(s) in the Project Explorer under <voiceprojectname>/Resources/Grammars. It's important to note that DTMF is considered a **locale** for the purpose of exportation. As such, an export result for a GBuilder resource with English and DTMF would be placed in <voiceprojectname>/Resources/Grammars/en-US and <voiceprojectname>/Resources/Grammars/DTMF directories, respectively. These files can now be edited in the [GRXML Editor](#).

Locales and Grammar Builder

When using the Grammar Builder, you specify *locales*, which are the languages that a grammar file will support. The Grammar builder wizard uses the active locales for the Composer Project.

See [Locales](#) in [CommonBlocks & Functionality](#).

Dynamic Grammars

Dynamic grammars are used for automated speech recognition (ASR). They are generated "on-the-fly" based on information dynamically pulled out from data sources such as databases, web services, or the file system. Contrast this to using a static grammar file whose content is fixed. The ASR engine matches the user utterance with the grammar. Returned values are then passed back to the application based on any matches in the grammar.

There are several ways to include dynamic grammars in voice dialogs:

- Use a dynamic VXML page template that creates the dynamic grammar and insert it in-line into the VXML page. Using a dynamic VXML page will provide flexibility in terms of the data source used to generate the grammar.
- If data is being retrieved from a database, using the **DB Input** block may be another alternative. It generates a grammar based on data retrieved from a database using the **DB Data** block. It can also generate a grammar based on contents of a JSON array that may have been retrieved from alternate data sources e.g., a Web Service.

Working with CTI Applications

Composer provides **CTI blocks** for two CTI scenarios supported by GVP:

- SIP Server (SIPS) scenario, which uses the Genesys SIP Server component to gain access to CTI functionality.
- CTI Connector (CTIC) scenario, which uses GVP's CTI Connector component to access CTI functionality provided by Genesys Framework.

These two scenarios do not provide identical capabilities and key differences are highlighted later in these topics. Composer provides four CTI blocks for accessing CTI functions. It generates VXML for each of these blocks that can work in either CTI scenario (SIPS or CTIC), and does not ask the user to choose between the SIPS or CTIC scenarios at design time. The decision to use CTIC or SIPS is made at runtime based on the X-Genesys headers received from GVP's Resource Manager. Therefore, the Composer user interface does not need to expose a Project-level preference for specifying the CTI scenario. **Note:** The CTI Connector provides different capabilities depending on the configuration in which other Genesys components like the IServer are deployed. For more details, please refer to the GVP documentation. Also see [GVP Debugging Limitations](#).

Design Paradigms for CTI Applications

There are two design paradigms for building CTI applications with GVP in which Composer can be used:

- Standard VXML Applications
- URS-Centric Applications

These paradigms differ in the extent to which the VXML application is involved in performing call control. **Standard VXML Applications** In this paradigm, the VXML application gets invoked first and can go through VXML interactions with the caller before using the <transfer> tag to transfer the call to another party such as queuing for an agent. At this point, the control of the call is passed to the SIP Server or CTI Connector while waiting for an agent. During this time, SIP Server or CTI Connector may invoke additional call treatments on GVP like playing music or invoking other applications. **URS-Centric Applications** In this paradigm, the VXML application is always invoked as a treatment by Genesys URS. The incoming call is controlled by Genesys URS and a strategy retains full control of the call. The strategy invokes specific treatments on GVP IVR as a media server to play prompts, play music, collect user input or execute a VXML application. In this paradigm, the VXML application does not use tags like <transfer> nor does any other kind of call control. Those decisions are left to the strategy. The VXML application returns user input collected during the call back to the strategy and lets the strategy make all call control decisions. Composer can be used to write VXML applications following either of the above paradigms.

Typical CTI Callflow

Before you start building a typical CTI application, the following information is required:

- The Genesys Virtual Route Point destination address. This is the address/location where the Genesys strategy is present (an integer number--for example, 5001).
- Strategy application on the Framework side (IRD) to find and transfers the call to an agent.

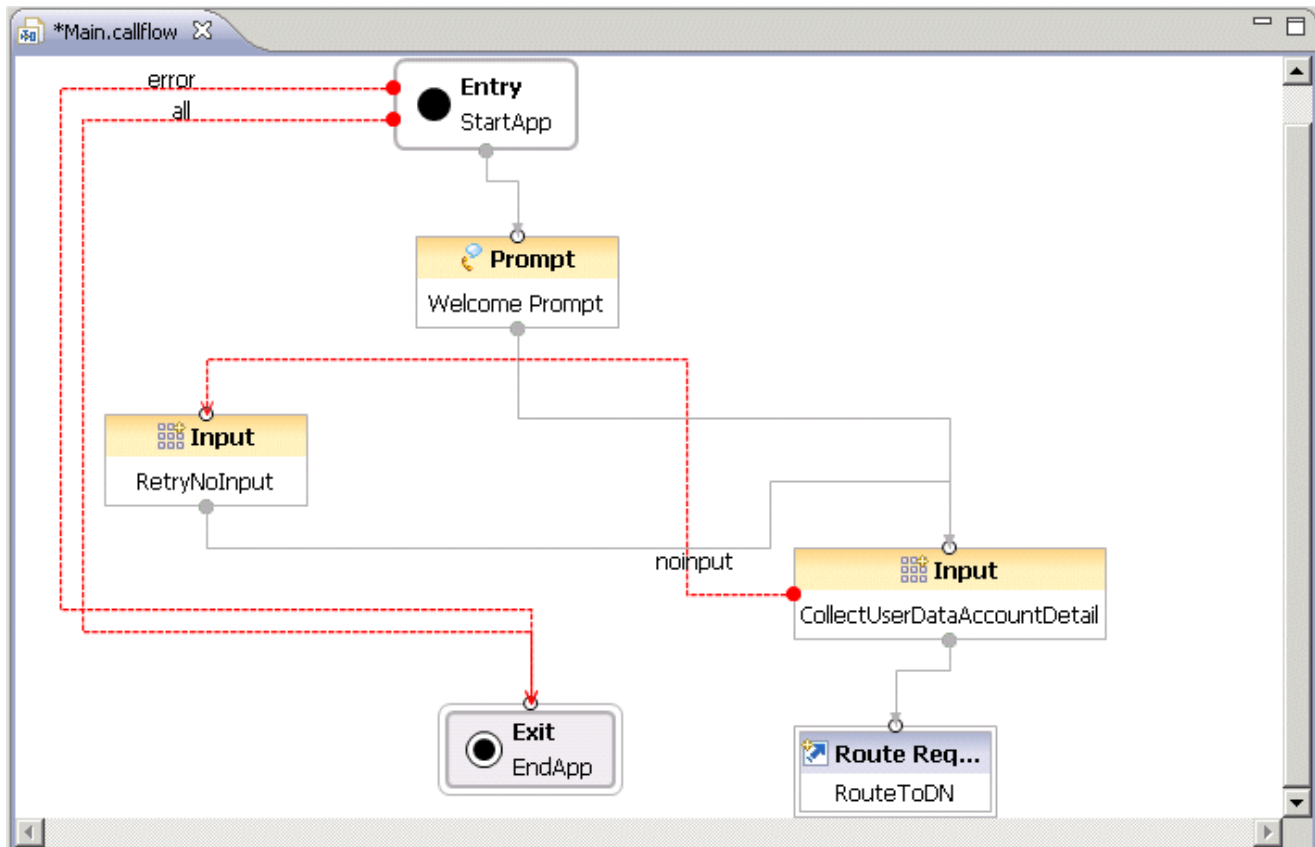

The following describes the interaction flow of this callflow:

1. GVP starts executing the generated VoiceXML application script.
2. The caller hears the Welcome prompt.
3. The caller is requested to enter the account details.
4. If the caller does not enter the required details within the maximum time frame provided, the caller is asked to retry.
5. The application issues a route request to the route DN configured in the **Route Request** block. (This occurs via the <transfer> tag, supported in both CTIC and SIP Server scenarios.)
6. The caller-entered data is sent as UserData to the routed DN, and the called strategy does the knowledge based transfer to the available agent based on the User Data .

7. This application ends after the Route Request has been issued.
8. The called strategy can play Voice treatments to the caller until the next available agent is available.
9. Finally, the caller will be transferred to the Agent.

Note: The **Route Request** block can be configured in various Transfer modes (Bridge / Consultation) to gain back the control of the callflow after the called strategy returns back the execution. Please check the Route Request topic block for more details.

CTI Scenarios

There are feature differences between the SIPS and CTIC scenarios. The following table gives a summary of the **CTI blocks**, and for each CTI block it lists the differences in behavior for the two CTI scenarios.

CTI Block Name	Supports CTIC Case?	Supports SIPS Case?	Comments
Interaction Data Block	Yes	Yes	<p>Supported operations in each scenario:</p> <p>CTIC:</p> <ul style="list-style-type: none"> • PUT • GET • DELETE • DELETEALL • REPLACE <p>SIPS:</p> <ul style="list-style-type: none"> • PUT • GET <p>Types of interaction data supported: CTIC:</p> <ul style="list-style-type: none"> • USERDATA <p>SIPS:</p> <ul style="list-style-type: none"> • USERDATA
Get Access Number Block	Yes	No	<p>Get access number block can only be used in the CTIC scenario.</p> <p>Types of interaction data supported: CTIC:</p> <ul style="list-style-type: none"> • USERDATA • EXTENSIONDATA

Statistics Block	Yes	No	Statistics block can only be used in the CTIC scenario.
Route Request Block	Yes	Yes	Types of interaction data supported: CTIC: <ul style="list-style-type: none"> • USERDATA • EXTENSIONDATA SIPS: <ul style="list-style-type: none"> • USERDATA Types of transfers supported: CTIC: <ul style="list-style-type: none"> • Blind • Bridge SIPS: <ul style="list-style-type: none"> • Consultation • Blind • bridge

In case a CTI block or feature is used in a CTI scenario in which it is not supported, appropriate exceptions will be thrown at runtime indicating that the feature is not supported. The table below gives a list of all exceptions that can be thrown by CTI blocks and other possible CTI-related exceptions that can be thrown if errors are encountered at runtime.

Block(s)	Exception	Error Message	Description
Interaction Data Block Get Access Number Block, Statistics Block	error.com.genesyslab.composer.InvalidKey	Missing <block name> key <key name>	This is the event error for handling an invalid key name.
Interaction Data Block Get Access Number Block Statistics Block, Route Request Block	error.com.genesyslab.composer.OperationTimeout	Operation timed out	This exception will be thrown when a <receive> operation, executed in the context of a CTIC specific operation, times out.
Interaction Data Block Get Access Number Block Statistics Block Route Request Block	error.com.genesyslab.composer.receiveError	<Error string returned by CTIC>	If the <receive> fails and an error is reported by CTIC, this exception will be thrown.
Interaction Data Block	error.com.genesyslab.composer.DeleteOperationNotSupported	Delete operation not supported in case of CTI using SIPServer.	If the user wants to do a userdata DELETE in the CTI using SIPS scenario.
Interaction Data Block	error.com.genesyslab.composer.DeleteASOperationNotSupported	Delete AS operation not supported	If the user wants to do a

		supported in case of CTI using SIPServer.	userdata DELETEALL in the CTI using SIPS scenario.
Interaction Data Block	error.com.genesyslab.composer.unsupported	Replace operation not supported in case of CTI using SIPServer.	If the user wants to do a userdata REPLACE in the CTI using SIPS scenario.
Get Access Number Block	error.com.genesyslab.composer.unsupported	AccessNumGet operation not supported in case of CTI using SIPServer.	If the user wants to do a AccessNumGet in the CTI using SIPS scenario.
Statistics Block	error.com.genesyslab.composer.unsupported	Statistics block not supported in case of CTI using SIPServer.	If the user wants to do a PeekStatReq or GetStatReq in the CTI using SIPS scenario.
Route Request Block	error.com.genesyslab.composer.unsupported	Consultation transfer is not supported in case of CTI using CTIConnector.	If user sets Transfer type to consultation in case of CTI using SIPS.

Script ID Usage in the GVP 8 Environment

In Genesys VoiceXML 2.1, ScriptId refers to the script identifier, as generated by the CTI Connector, to handle call treatments. The use of ScriptId is specific to GVP 7.x and was mandatory for treatments. Since the GVP 7.x design is "IVR-centric," the treatment would be invoked on the same VXML session. Things are a bit different with GVP 8.x and the Next Generation Interpreter (NGI) where APP_URI is used instead of ScriptId and the treatments are executed on different VXML sessions. **GVP 8 and NGI** In GVP 8.x, request for treatment execution comes in as a NETANN request with the APP_URI being passed in as a VoiceXML parameter. GVP executes the requested page to kick off the treatment. Unlike the GVP 7.x environment, treatments get invoked as separate VXML sessions and terminated at the end of the treatment execution. Hence, ScriptId switching is no longer needed here, unless an application wants to do branching based on ScriptId.

- Note: Composer provides support for both SIPS and CTIC scenarios for achieving the CTI functionality. However, SIPS may not support passing additional request-uri parameters like ScriptId, therefore, this option is limited only to CTIC scenarios.

Please refer to *GVP 8.x VXML Help* under Sample Voice XML Applications > CTI Interactions > Treatments for more details on this topic.

Accessing ScriptId in Composer

Use if you want your application to do ScriptId-based switching like GVP 7.x. **CTIC Scenario (IRD strategy + Composer Callflow)**

1. Use the APP_ID property in IRD's Play Application block.
2. Define a new **Input** type variable named ScriptId in the Entry block of your callflow to collect the ScriptId.

Composer Workflow + Composer Callflow)

1. On the VXML callflow side, define a new **Input** type variable named ScriptId in the Entry block to collect the APP_ID (i.e., ScriptId) passed from the workflow.
2. On the SCXML workflow side, use the **Play Application** block to invoke the callflow created using step#1. Then do an auto-synchronize for the parameters, and specify the ScriptId value.
3. The ScriptId (i.e., APP_ID) passed from the workflow will be automatically collected on the VXML side from the session.connection.protocol.sip.requesturi array.

SIPS Scenario

1. SIPS may not support passing additional request-uri parameters. Pass ScriptId as attached data on the strategy side (If using IRD) or on the SCXML side (If using Composer workflows).
2. Define a new **Input** type variable named ScriptId in the Entry block to collect the ScriptId.
3. The ScriptId (i.e., APP_ID) passed from the strategy will be automatically collected on the VXML side from the session.com.genesyslab.userdata array.

Selecting a Composer Project

To select a Composer Project for which to manage prompts, the Prompts Manager view:

- Select a project from the Composer Project drop-down list.

Selecting a Language Resource

- Select a Language Resource. If not using en-US, see the special note on [Non-US Locales](#).

The Prompts Manager displays all the prompt-related blocks for all the callflows in the selected Project.

The screenshot shows the Eclipse IDE interface. On the left, the Project Explorer displays a project structure with folders like 'Callflows', 'db', 'include', 'Interaction Processes', 'META-INF', 'Reports', 'Resources', 'Scripts', and 'src'. The main editor area shows a callflow diagram with three blocks: 'Entrv', 'Prompt', and 'Exit'. The 'Prompt' block is highlighted. Below the diagram, the Prompts Manager view is open, showing a table of prompts for the selected project and language resource.

Prompts	Type	Value	Alternate Text	Time Sta...	Instructio...	Notes
NonBusinessHrs						
VoiceMail_Prompt						
HelloWorld_Proi	Value	Please call back ...	N/A			
WeekendMsg						
WeekEndMsg_Proi						
HelloWorld_Proi	Value	Thanks for cont...	N/A			
default						
MainMenu						
PromptGoodbye						

Notes

- The Prompts Manager will not work with non-Composer projects (such as hand-coded applications).
- Note the Language Resource dropdown selection box. The prompt audio resource is located in the appropriate language resource folder location (for example: /Resources/Prompts/<locale>/audioResourceFile.vox).
- Starting with 8.0.2, a Composer Project upgrade sets the default Project locale to en-US. If other than en-US, right-click the Composer Project in the Project Explorer, and select **Properties > Locales** to set the default and active locales.
- Use only a 32-bit Eclipse environment to play audio files from the Prompts Manager view. If you are using a 64-bit version Eclipse environment, playing audio throws the following error:

```
java.lang.UnsatisfiedLinkError: .\configuration\org.eclipse.osgi\bundles\470\1\cp\
```

AFUtil.dll: Can't load IA 32-bit .dll on a 64-bit platform.

Columns in the Prompts Manager View

A prompt item row in the Prompts Manager view displays the following column details:

- **Prompts** -- A tree hierarchy consisting of the following elements; Root elements, studio diagram callflow/sub-callflow file name. Studio diagram elements may have diagram block elements. These diagram block elements may have prompt/retry prompt item elements.
- **Type** -- The type of prompt item (audio resource/value/variable)
- **Prompt Item Text** -- Any associated text with the prompt item.
- **Audio File** -- The relative path of the audio file associated with this prompt item.
- **Time Stamp** -- The Date/Time stamp when the audio file was created or recorded. This helps in identifying the newer/older prompts.
- **Instructions** -- If additional item specific information needs to be given, such as a certain word needs to be emphasized when recording at the recording studio.
- **Notes** -- Any notes that you would like to associate with the prompt item for later reference.

Non-US Locales

By default, Composer provides prompts audio resources for the en-US locale. The supplied PlayBuiltinType.js under **Resources/Prompts** in the Project Explorer defines a global variable called **promptBaseUrl** with the value **en-US**. When using a different locale in a callflow (other than en-US in the Language Resource field in Prompts Manager), you must provide the associated audio files and PlayBuiltinType.js. Adjust the path with the associated prompt resource locale folder path.

Reviewing and Managing Prompts

Once you have laid out your diagram and wish to review the flow of the application, you can use the Prompts Manager to do the review. It is useful to have the callflow and Prompts Manager view open together so that the flow of the application can be traced using the callflow while reviewing prompts using the Prompts Manager. Select the Composer Project(s) containing prompts you wish to manage. You can review and manage your prompts as follows:

1. Expand a Prompt block in the Prompts column of the Prompts Manager view to display all prompts associated with that block.
2. Select a prompt row. The Prompts Manager view displays detailed information about the prompt.
3. You can view prompt item text in the Prompts Manager.

- For prompts that have an associated audio file, click the Play icon  in the Prompts

Manager view to hear the audio file.

- Click the Stop icon  to stop playing the audio file.

Note: To play back VOX audio files in their correct encoding (U-Law/A-Law), you may need to set the encoding properties in the Composer Project settings. To change the settings, go to the Project Explorer, right-click the Composer Project folder, and select Properties. Select the Prompts Management section and set the Encoding property accordingly.

4. To modify the sequential order of the prompt items within a block, select a prompt item element row and click the Up or Down icon.



in the Prompts Manager view.

5. To locate the diagram block in the studio diagram callflow that is associated with a selected row, right-click a prompt row and select Display in callflow from the context menu. If the callflow (or studio diagram) is not currently open, it will be opened in the editor and the selected block will be highlighted with a blue outline.
6. To modify a value (for example, the prompt item name, the prompt item text, and so on) from within the Prompts Manager view, double-click the table cell, type a new value, and press Enter. Certain table cell values may not be modified.(for example, callflow diagram name, prompt type, and so on).

Supported Audio File Formats Audio files are encoded and outputted in various audio file formats. The following audio file formats are recommended and supported for playback and recording within Prompts Manager:

File Extension	Sample Rate	Sample Size	Bit rate (Bandwidth)	File Format	Encoding
.vox	8000 Hz	8-bit	64 bits/sec	Raw audio (mono)	u-law
.vox	8000 Hz	8-bit	64 bits/sec	Raw audio (mono)	a-law
.wav	8000 Hz	8-bit	64 bits/sec	Audio with .wav header (mono)	PCM

Refer to the VoiceXML 2.1 Reference Help on the [Genesys Voice Platform Wiki](#) for additional formats that GVP supports. Those additional formats can be played back and recorded using third party tools outside of Composer.

Recording Prompts

The Prompts Manager view provides a button to launch a recorder/player that can record and play back a single prompt item's audio file. The newly-recorded file will replace any existing audio file associated with the highlighted prompt item. **Notes:**

- Related prompt audio settings are located in the Composer Project Settings. In the Project Explorer,

right-click the Composer Project folder, and select Properties. Select the **Prompts Management** section for prompt audio settings.

- To record a prompt item using Prompts Manager, the prompt item must be of type Resource in the Prompts Manager view. If you do not want to specify an audio resource at this time or wish to record your own resource prompt using the Prompts Manager, you may instead define a value in the **Alternate Text** field shown below.

Important

Please note for recording prompts that are of type **Value** to interpret-as "Text," you will need to change the prompt type to **Resource**. Supply the prompt text value in the **Alternate Text** field for the Resource prompt type.

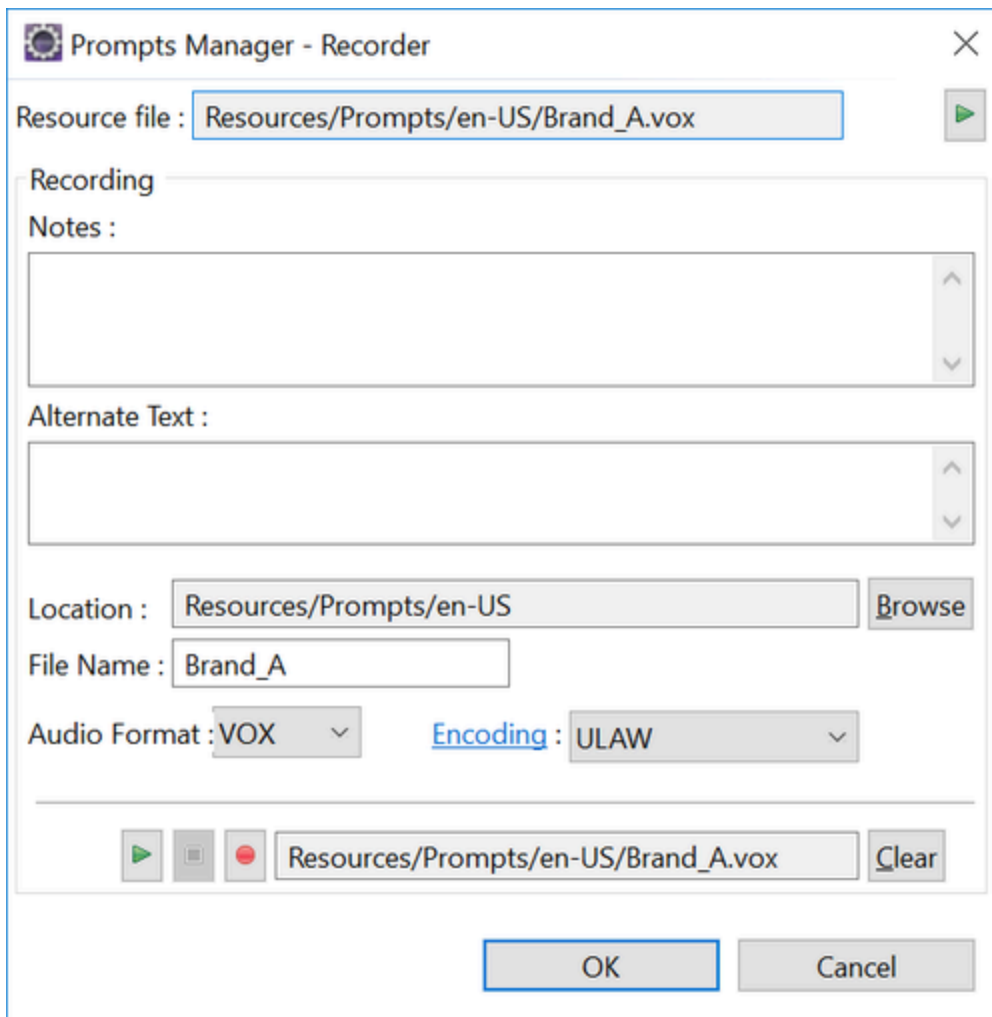

To record a prompt from within the Prompts Manager view:

1. Select a callflow within a Project.
2. Open the Prompts Manager (**Window > Show View > Prompts Manager**).
3. Select an existing prompt row of type **Resource**.
4. Click the Record icon  to open the Prompts Manager - Recorder dialog box as shown below:



The Prompts Manager - Recorder dialog box assists in the recording, playback, and storing of the audio file.

1. Type any notes for this prompt in the **Notes** field.
2. Type an alternate text string in the **Alternate Text** field. This text is used to generate audio using #Text-to-Speech in place of the audio file should the audio file not be available at runtime.
3. Select the default recording **Location**, or click **Browse** to navigate to an alternate location. Note: Genesys recommends that you keep your language specific audio files in the/Resources/Prompts/<language-code> folder.
4. Type a recording file name or keep the current name.
5. If the audio recording format displayed in the Recorder is not the format you wish to use, click **Audio Recording Format** to open the Properties dialog box for this Composer Project, from which you can change the audio format to **WAV** or **VOX**. You can also specify the encoding as **ALAW** or **MULAW**.
6. Click **OK** in the Properties dialog box to accept the new audio format setting for this Composer Project.
7. Click **Clear** if you want to clear the current resource file and create a new one.

8. Click the **Record** icon  to record your audio prompt. A microphone should be connected and volume levels should already be set properly.
9. Click the **Stop** icon  to stop the recording.
10. Click the **Play** icon  to play back the new audio prompt. You can re-record if necessary.
11. Click **OK** when you are finished to close the Prompts Manager - Recorder dialog box. At this point, Prompt Manager will save any changes you have made. If you click Cancel, no changes are saved to the project.

Exporting a Prompt Listing

The Composer Prompts Manager provides the ability to export a prompt listing of all prompts in a Composer Project along with the attributes shown in Prompts Manager, such as instructions and notes. This facility is useful if you need to send your prompts out for professional recording and want to include instructions and text to be recorded along with prompt names. To export a prompt listing from within the Prompts Manager view:

1. Click the **Export Composer Project Prompts** icon  in the Prompts Manager view, or
2. From the File menu, select **Export**. Expand **Composer** and select **Export Prompt Listing**, or
3. Right-click with any prompt or Prompt block selected, and select **Export Composer Project Prompts** from the context menu, to open the Export dialog box.
4. Select the Composer Project whose prompts you wish to export from the drop-down list.
5. Select the file format for your exported data from the drop-down list. You may select either **xml** or **csv** format.
6. Click **Browse** to navigate to a destination location to hold your prompt export file. The exported file will have the name: <voiceprojectname>.xml or <voiceprojectname>.csv.
7. Click **Finish** to complete the export request.

XML Format Description Below is an example snippet from a prompt listing export in XML format:

```
<prompts project="JavaComposerProject_Voice_Business"> <prompt callflow="Main"
block="WelcomePrompt" name="WelcomePrompt_Prompt1" type="Resource" interpret-
as="Audio" value="Resources/Prompts/en-US/Brand_A.vox" format="" alternateText=""
instructions="" notes="" /> ... </prompts>
```

XML Tag	Attribute Name	Description
<prompt>	project	The Composer project that is being exported.
<prompt>	callflow	The name of the callflow diagram where the prompt resides.
<prompt>	block	The name of the diagram block where the prompt resides.
<prompt>	name	The name of the prompt item.
<prompt>	type	The type of prompt, such as

		Value, Resource, or Variable.
<prompt>	interpret-as	The interpretation of the prompt value.
<prompt>	value	The value of the prompt item.
<prompt>	format	If applicable, the format of the value. Used for interpret-as, Date or Time. For example, 24 Hour or 12 Hour.
<prompt>	alternatetext	The alternate text for the prompt. Used for an invalid value. For example, if an audio resource does not exist or the variable data is invalid.
<prompt>	instructions	Text for additional or specific information instructions. For example, if a certain word needs to be emphasized when recording at the recording studio.
<prompt>	notes	Any further notes from the user. For example, identify if an associated audio file was recorded by the Prompts Manager or if the audio file was from a recording studio. Shows the source, which will be set by the user (Recorded/Imported/Unknown).

CSV Format Description The CSV format separates each prompt-related value by commas. The ordered values represents the following:

1. **Callflow**
2. **Block Name**
3. **Prompt Type**
4. **Interpret-As**
5. **Prompt Name**
6. **Value**
7. **Format**
8. **Alternate Text**
9. **Instructions**
10. **Notes**

The following is a snippet from the prompt listing Export in CSV format:

```
Main,WelcomePrompt,Resource,Audio,WelcomePrompt_Prompt1,"Resources/Prompts/en-US/Brand_A.vox",",",",","
```

Prompt Listing Usage For a Recording Studio

A recording studio may use the details in the sample exported prompt listing below when preparing an audio recording for a prompt item. This transcript-like format is intended to assist with producing professional sounding recordings. The five prompt items are in sequenced order to provide a sense of tone in relation to where the recorded message is at the beginning/middle/end of the overall message. The recorder:

- Uses the block name attribute to determine which set of prompt items belong together.. For example, the last five prompt items are from the same Menu1 prompt block.
- Is typically interested in prompts where type="Resource" and interpret-as="Audio", as these are the audio resources that are to be professionally replaced.
- Uses the value from the alternateText attribute to determine what should be said for the recording.
- Uses the instructions attribute for additional details from the developer, such as instructions to emphasize a certain word in the prompt message.

Sample Exported Prompt Listing

```
<prompts project="JavaComposerProject_Voice_Business"> <prompt callflow="CompanyABC"
block="Prompt1" name="Prompt1_PromptMsg1" type="Resource" interpret-as="Audio"
value="Resources/Prompts/en-US/Welcome.vox " format="" alternateText="Welcome to A B
C bank." instructions="" notes="Prompts Manager recorded file." /> <prompt
callflow="CompanyABC" block="Menu1" name="Menu1_PromptMsg1" type="Resource"
interpret-as="Audio" value="Resources/Prompts/en-US/MainMenu_A.vox" format=""
alternateText="Main menu." instructions="" notes="Default Composer audio file." />
<prompt callflow="CompanyABC" block="Menu1" name="Menu1_PromptMsg2" type="Resource"
interpret-as="Audio" value="" format="" alternateText="To check your balance press
one or say check balance." instructions="Place emphasis on 'check balance'" notes=""
/> <prompt callflow="CompanyABC" block="Menu1" name="Menu1_PromptMsg3"
type="Resource" interpret-as="Audio" value="" format="" alternateText="To make a bank
to bank transfer press two or say transfer." instructions="Place emphasis on the word
'transfer'" notes="" /> <prompt callflow="CompanyABC" block="Menu1"
name="Menu1_PromptMsg4" type="Resource" interpret-as="Audio" value="" format=""
alternateText="To repeat these options press five or say repeat." instructions="Place
emphasis on the word 'repeat'" notes="" /> <prompt callflow="CompanyABC"
block="Menu1" name="Menu1_PromptMsg5" Naming For ease of importing the new audio recordings
into Composer, Genesys recommends making the name the same as the attribute value of the
respective prompt entry. For example, MainMenu_A.vox in the below snippet. This avoids having to
rename the files when they are imported into Composer as described in the Importing Prompt
Resources topic. <prompt callflow="CompanyABC" block="Menu1" name="Menu1_PromptMsg1"
type="Resource" interpret-as="Audio" value="Resources/Prompts/en-US/MainMenu_A.vox"
format="" alternateText="Main menu." instructions="" notes="Default Composer audio
file." />
```

Importing Prompt Resources

See the [Sample Exported Prompt Listing](#), which should be used as a transcript by the recording studio. After receiving the prompt audio resources from the professional audio recording studio, be sure to place the audio files in the correct Composer Project resource path. This ensures that the resources will work properly with the existing callflows that will use them. The Composer prompt resources are stored under the Composer Project folder `../Resources/Prompts`. Example: `../Resources/Prompts/en-US/Brand_A.vox` For a prompt item with audio resource `Resources/Prompts/en-US/Brand_A.vox`, the new professionally recorded audio file must be identically located and named `Resources/Prompts/en-US/Brand_A.vox`. If you do not do this, you must go to the callflow diagram block properties to set the new prompt resource path, or rename the file to match existing prompt settings. **Note:** When importing multilingual prompts, be sure to place the audio resource files in their corresponding prompt resource locale folder. For example,

- **English** -- United States `../Resources/Prompts/en-US`
- **Spanish** -- Spain `../Resources/Prompts/es-ES`

To import file resources to the target Composer Project, use the Project Explorer. Or simply copy and paste the files to the target prompts resource folder location of the Project Explorer. As an alternative, importing may be achieved by using `File > Import...` Expand and select **General > File System**. In the Import dialog, set the **From** directory field and Into folder fields, select the desired files, and click **Finish**. A sample is shown below.

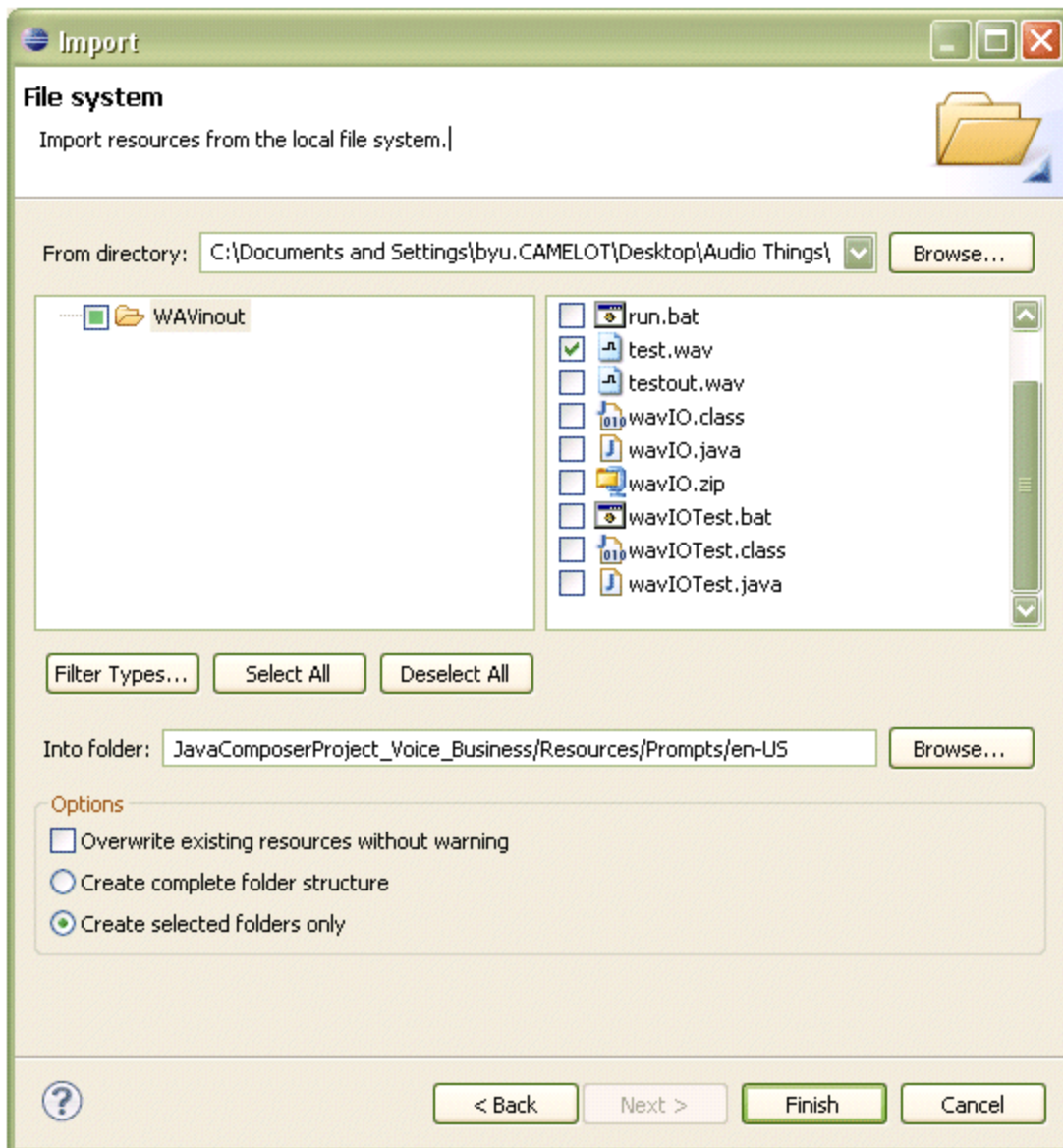

Connection Pooling

When defining a database connection profile, you can use connection pooling, which maintains a set of database connections that can be reused for requests to databases. This feature can enhance performance by avoiding time-consuming re-establishment of connections to databases. While Composer does not [support specific application servers](#), this topic presents information on configuring [Tomcat](#), [JBoss](#), and [Websphere](#) application servers to expose a pooled data source as a JNDI resource. This topic also contains information on [creating a JDBC provider for an Oracle database](#).

Important

When upgrading projects to a 8.1.5 branch (starting with version 8.1.500.03 to 8.1.541.07), please perform the following steps to avoid issues with DB connection pooling:

1. Stop the Tomcat service (if it happens to be a service) or manually shut down the server.
2. Download the `mchange-commons-java-0.2.15.jar` file from the Maven repository (<https://mvnrepository.com/artifact/com.mchange/mchange-commons-java/0.2.15>).
3. Copy the downloaded JAR to the `<tomcat_installed_directory>\lib` location in the physical directory.
4. Restart Tomcat.

Note: You do not have to perform the above steps if you are upgrading to a 8.1.5 branch that was released after version 8.1.541.07.

Connection Pooling for Tomcat Application Servers

For Tomcat, a JNDI resource is defined in a Context configuration. Do this in the global scope, at `$TOMCAT_HOME/conf/context.xml`. Here is a sample:

```
<Context> ...  
  
<Resource name="jdbc/pooledDS" auth="Container"  
    type="com.mchange.v2.c3p0.ComboPooledDataSource"  
    factory="org.apache.naming.factory.BeanFactory"  
    driverClass="com.microsoft.sqlserver.jdbc.SQLServerDriver"  
    user="john" password="doe123"  
    jdbcUrl="jdbc:sqlserver://dbserver1:1433;databaseName=composer1" />
```

```
<Resource name="jdbc/oraclePooled" auth="Container"
  type="com.mchange.v2.c3p0.ComboPooledDataSource"
  factory="org.apache.naming.factory.BeanFactory"
  driverClass="oracle.jdbc.driver.OracleDriver" user="jane" password="doe456"
  jdbcUrl="jdbc:oracle:thin:@dbserver2:1521:composer2" />... </Context>
```

Important Items

- name--should match the Connection Pool Name parameter given in the Connection Profile in Composer.
- user, password--these are the login credentials to the database.
- jdbcUrl--specifies the host, port and database name. Can be copied from the Connection Profile editor in Composer. The JDBC URL can also use advanced options that might not be otherwise exposed by Composer. For example, to enable Transparent Application Failover for a connection to an Oracle database, the URL can be given as:

```
jdbcUrl="jdbc:oracle:oci:@(DESCRIPTION=(LOAD_BALANCE=on) (FAILOVER=on) (ADDRESS=(PROTOCOL=tcp) (HOST=host2) (PORT=1521)) (CONNECT_DATA=(SERVICE_NAME=dbcluster) (FAILOVER_MODE=(TYPE=session) (METHOD=basic))))"
```

Additional Pooling Parameters

Additional pooling parameters can be customized here as well, for example:

```
<Resource name="jdbc/pooledDS" auth="Container"
  type="com.mchange.v2.c3p0.ComboPooledDataSource"
  factory="org.apache.naming.factory.BeanFactory"
  driverClass="com.microsoft.sqlserver.jdbc.SQLServerDriver"
  user="john"
  password="doe123"
  jdbcUrl="jdbc:sqlserver://dbserver1:1433;
  databaseName=composer1"
  maxPoolSize="20" acquireRetryAttempts="0" /
```

For a full list of available settings, refer to the c3p0 documentation, which is the third-party connection pooling library used by Composer

<http://www.mchange.com/projects/c3p0/index.html>
<http://www.mchange.com/projects/c3p0/index.html>.

Connection Pooling for JBoss Application Servers

To define connection pooling for JBoss:

1. Add the c3p0 and JDBC driver JARs to JBoss's global lib directory (\$JBoss_HOME/server/<instance>/lib). This is because JBoss will initialize the connection pool upon startup regardless of what applications are deployed. This is in contrast to Tomcat, which creates the connections on demand.

- Next, define the JNDI resources in a file called `c3p0-service.xml`. Copy the file into `$JBOSS_HOME/server/<instance>/deploy`.

Sample:

```
<?xml version="1.0" encoding="UTF-8"?> <!DOCTYPE server> <server> <mbean
code="com.mchange.v2.c3p0.jboss.C3P0PooledDataSource"
name="jboss:server=SQLServerDS"> <attribute name="JndiName">java:jdbc/
pooledDS</attribute> <attribute
name="JdbcUrl">jdbc:sqlserver://dbserver1:1433;databaseName=composer1</attribute>
<attribute
name="DriverClass">com.microsoft.sqlserver.jdbc.SQLServerDriver</attribute>
<attribute name="User">john</attribute> <attribute
name="Password">doe123</attribute> </mbean> <mbean
code="com.mchange.v2.c3p0.jboss.C3P0PooledDataSource" name="jboss:server=OracleDS">
<attribute name="JndiName">java:jdbc/oraclePooled</attribute> <attribute
name="JdbcUrl">jdbc:oracle:thin:@dbserver2:1521:Composer2</attribute> <attribute
name="DriverClass">oracle.jdbc.driver.OracleDriver</attribute> <attribute
name="User">jane</attribute> <attribute name="Password">doe456</attribute>
</mbean> </server>
```

Pooling Parameters

Specify pooling parameters are specified by adding more `<attribute>` elements, e.g.,

```
<mbean code="com.mchange.v2.c3p0.jboss.C3P0PooledDataSource"
name="jboss:server=OracleDS"> <attribute name="JndiName">java:jdbc/
oraclePooled</attribute> <attribute name="JdbcUrl">jdbc:oracle:thin:@dev
dbserver2:1521:Composer2</attribute> <attribute
name="DriverClass">oracle.jdbc.driver.OracleDriver</attribute> <attribute
name="User">jane</attribute> <attribute name="Password">doe456</attribute>
<!-- note that the attribute names must be capitalized --> <attribute
name="MaxPoolSize">20</attribute> <attribute
name="AcquireRetryAttempts">0</attribute> </mbean> For a full list of available settings, refer to
the c3p0 documentation, which is the third-party connection pooling library used by Composer
([http://www.mchange.com/projects/c3p0/index.html http://www.mchange.com/projects/c3p0/
index.html]).
```

Configuration Files

The following configuration files are automatically generated by Composer's WAR export functionality and do not require any user action: `web.xml` and `jboss-web.xml`

web.xml In the web application itself, the deployment descriptor (`WEB-INF/web.xml`) needs to specify a resource reference: `<resource-ref> <res-ref-name>jdbc/pooledDS</res-ref-name><res-type>javax.sql.DataSource</res-type><res-auth>Container</res-auth</resource-ref>` **jboss-web.xml**

This special JBoss-specific configuration file (`WEB-INF/jboss-web.xml`) is required to map the resource-ref to the globally defined resource.

```
<?xml version="1.0" encoding="UTF-8"?> <jboss-web> <resource-ref> <res-ref-name>jdbc/
pooledDS</res-ref-name><res-type>javax.sql.DataSource</res-type><jndi-name>java:jdbc/
pooledDS</jndi-name></resource-ref> </jboss-web>
```

Connection Pooling for WebLogic Application Servers

When the application Server is WebLogic, there must be an extra configuration file in WEB-INF called `weblogic.xml`. First, though, confirm that the following is present in `web.xml` in the exported `.war` file:

```
<resource-ref> res-ref-name=jdbc/poolDS</res-ref-name> </res-type>
<res-auth>Container</res-auth> </resource-ref>
```

`res-ref-name` should match the pool name in the `connection.properties` file, and it should be prefixed by `jdbc/`

weblogic.xml File The `weblogic.xml` can be added to the Composer Project in WEB-INF. Afterwards, you will have to export the `.war` file from Composer again and redeploy. The `weblogic.xml` should contain:

```
<?xml version="1.0" encoding="UTF-8"?>
<wls:weblogic-web-app xmlns:wls="http://xmlns.oracle.com/weblogic/weblogic-web-
app" xmlns:xsi="http://www.w3.org/2001/XMLSchema-instance"
xsi:schemaLocation="http://java.sun.com/xml/ns/javaee http://java.sun.com/xml/ns/
javaee/ejb-jar_3_0.xsd http://xmlns.oracle.com/weblogic/weblogic-web-app
http://xmlns.oracle.com/weblogic/weblogic-web-app/1.2/weblogic-web-app.xsd">
<wls:weblogic-version>12.2.1.3.0</wls:weblogic-version>
<wls:context-root>JavaComposerProject</wls:context-root>
<wls:resource-description>
<wls:res-ref-name>jdbc/poolDS</wls:res-ref-name>
</wls:resource-description>
</wls:weblogic-web-app>
```

Note the following:

The `wls:res-ref-name` should match `res-ref-name` in `web.xml`. `wls:jndi-name` should be the JNDI Name in the WebLogic configuration.

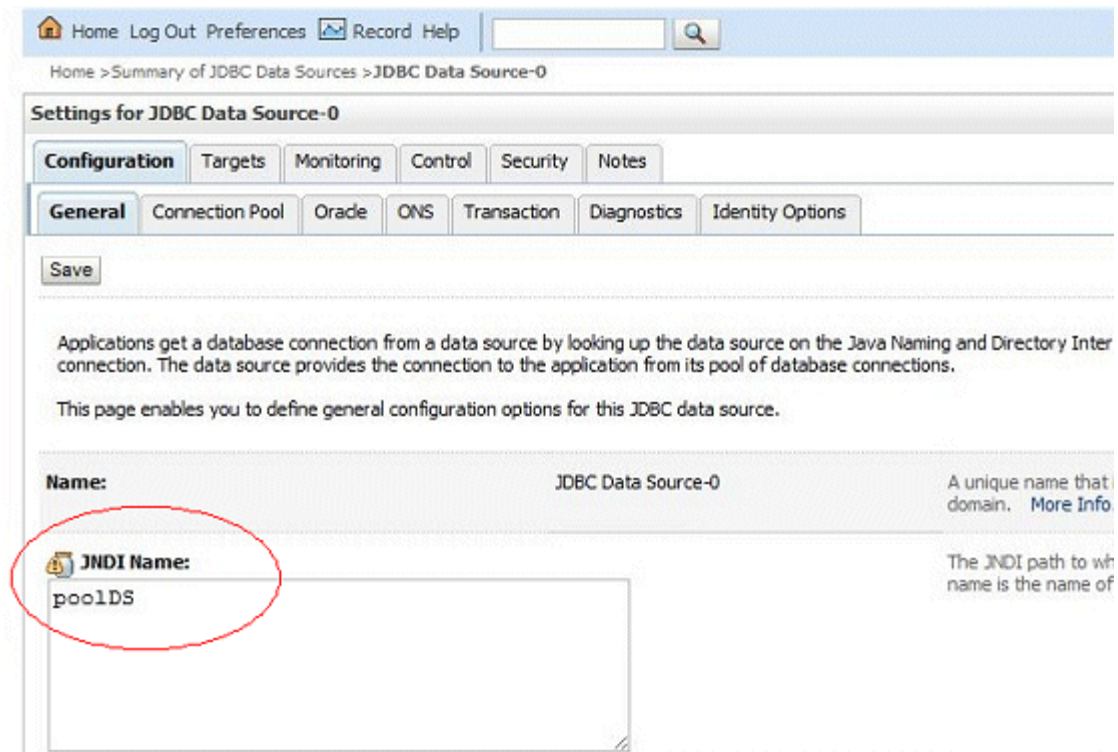

Connection Pooling for WebSphere Application Servers

WebSphere has its own connection pooling capabilities, so you won't be using c3p0. The data sources are defined in the WebSphere management console.

Configuration Files

The following configuration files are automatically generated by Composer's WAR export functionality and do not require any user action: web.xml and ibm-web-bnd.xmi

Creating a JDBC Provider for an Oracle Database

SQL Server driver is built-in for WebSphere. however, the Oracle driver must be configured as a JDBC provider.

1. From the left-hand side panel, open **Resources > JDBC > JDBC Providers**.
2. Click **New**.
3. In Step 1, choose the following:

Step 1: Create new JDBC provider

Step 2: Enter database class path information

Step 3: Summary

Create new JDBC provider

Set the basic configuration values of a JDBC provider, which encapsulates the specific vendor JDBC driver implementation classes that are required to access the database. The wizard fills in the name and the description fields, but you can type different values.

Scope
cells:qa5-h5Node01Cell

* Database type
Oracle

* Provider type
Oracle JDBC Driver

* Implementation type
Connection pool data source

* Name
Oracle JDBC Driver

Description
Oracle JDBC Driver

Next Cancel

JDBBProvider.gif

- In Step 2, specify the location of the `ojdbc14.jar` file. The JAR can be copied from Composer's `tomcat/lib` directory to a location local to the WebSphere server.

Creating Data Sources

- On the left-hand side panel, open **Resources > JDBC > Data sources**.
- Click **New**.
- Enter anything you like under **Data source name**.
- Under **JNDI name**, enter the name that matches the one given in the Connection Profile Editor. Hit **Next**.
- For the **Select JDBC provider** step, choose **WebSphere embedded ConnectJDBC** driver for MS SQL Server for SQL Server, or **Oracle JDBC** driver for Oracle. Hit **Next**.
- Enter the database name, host name and port of the database server. Click **Next**. Click **Finish** on the summary page.
- Next, you must specify the username and password for the database connection. Click on the data source that was just created and then click on the **Custom Properties** link.
- Create two new properties, called user and password, and specify the credentials for the database.
- After saving the data source, use the **Test Connection** button to test.

-
10. Use the **Connection Pool Properties**, link to customize the pooling settings. Refer to the WebSphere documentation for details.

The following items are generated by Composer's WAR export functionality and require no user action.

```
WEB-INF/web.xml is required, similar to JBoss.      <resource-ref
id="ResourceRef_1276009394684">      <res-ref-name>jdbc/pooledDS</res-ref-name>
      <res-type>javax.sql.DataSource</res-type>      <res-auth>Container</res-auth>
      </resource-ref> WEB-INF/ibm-web-bnd.xml does the same thing as jboss-web.xml does for
JBoss... <?xml version="1.0" encoding="UTF-8"?> <webappbnd:WebAppBinding
xmi:version="2.0" xmlns:xmi= "[http://www.omg.org/XMI" http://www.omg.org/XMI"];
xmlns:webappbnd="webappbnd.xmi" xmi:id="WebAppBinding_1276009185886"
virtualHostName="default_host"> <webapp href="WEB-INF/web.xml#WebApp_ID"/>
      <resRefBindings xmi:id="ResourceRefBinding_1276009394684" jndiName="jdbc/pooledDS">
      <bindingResourceRef href="WEB-INF/web.xml#ResourceRef_1276009394684"/>
      </resRefBindings> </webappbnd:WebAppBinding>
```

Common Properties for Callflow Blocks

The following properties are common to multiple blocks. Their descriptions are placed here to minimize duplication of content:

Name Property

The Name property is present in all blocks in Composer. The Name property is the first property for all blocks. Use the **Value** field beside in the **Name** property row of the block's property table to name the block.

- Block names should conform to ECMAScript and **VoiceXML** identifier naming conventions.
- There is no maximum limit to the number of characters allowed.
- Names must consist only of numbers, letters, and underscore characters.
- Names must begin with a letter or underscore.
- Except for the Entry and Exit blocks, you should give all blocks a descriptive name. For example, if an Input block asks the caller to input an account number, then the name of the block could be `Input_Account_Number`.
- The name of the block is used as the **Name** of the **VXML** `<form>` tag that gets generated for that block.

To provide a name for a block:

1. Select the **Name** row in the block's property table.
2. In the **Value** field, type a block name that conforms to the restrictions above.

Block Notes Property

Can be used to add comments.

Exceptions Property

Use this property to define which **exception events** the block is designed to handle. These are VoiceXML events that are either thrown by the interpreter, or generated in response to a caller action. Note: A catch handler called `all` has been added to catch all exception events. To handle (support) a specific event:

1. Click the **Exceptions** row in the block's property table.
2. Click the ... button to open the **Exceptions** dialog box.

3. From the list of events on the **Not Supported** pane, select the event that you want to handle.
4. Click the **Add >** button to move the event to the **Supported** pane.

An example is shown below.

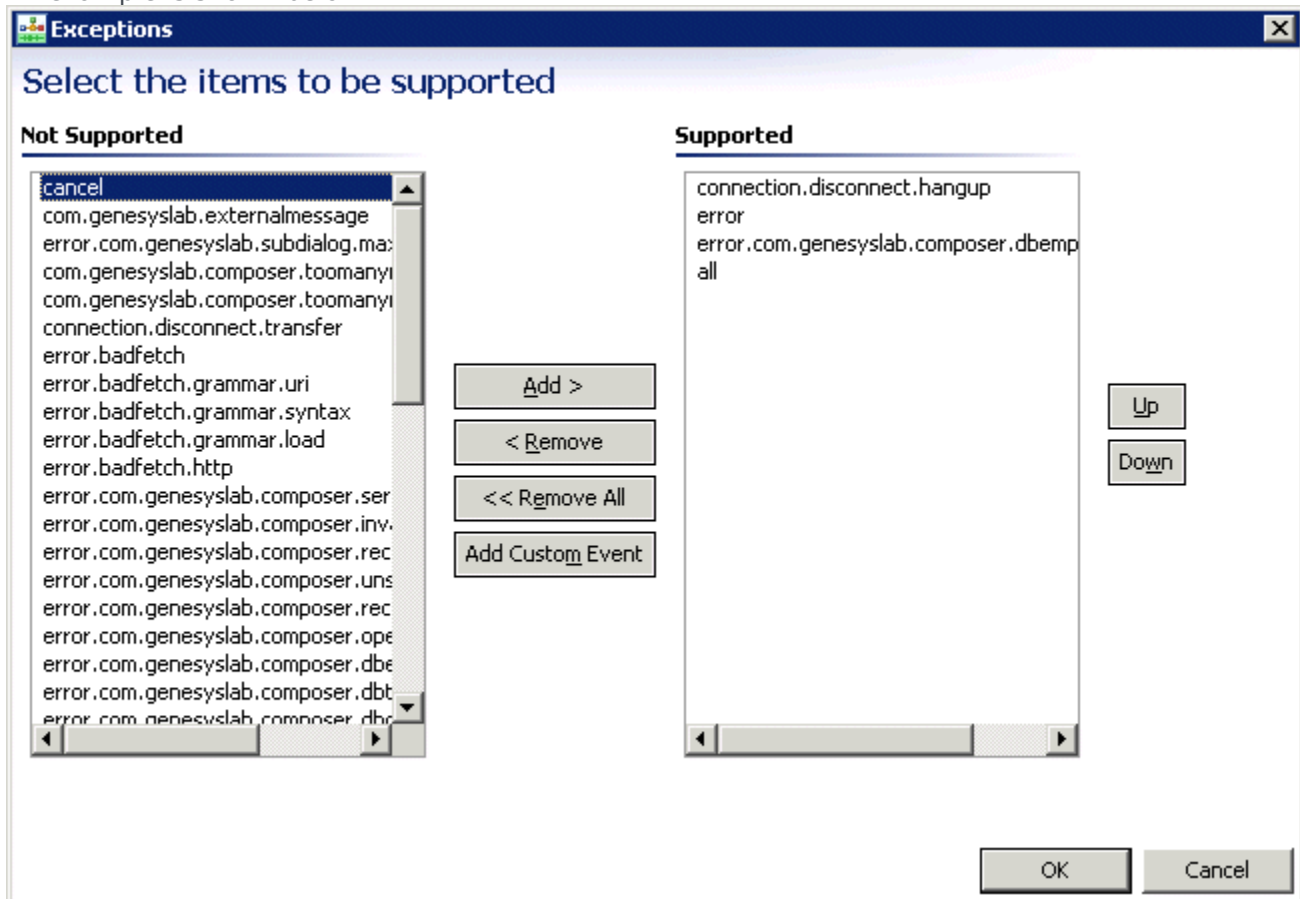

To explicitly not handle (not support) a specific event marked as supported:

1. Click the **Exceptions** row in the block's property table.
2. Click the ... button to open the **Exceptions** dialog box.
3. From the list of events on the **Supported** pane, select the event that you do not want to handle.
4. Click the **< Remove** or **< Remove All** button to move the event (or all events) to the **Not Supported** pane.

To rearrange (reorder) the sequence of events on the **Supported** pane:

1. Click the **Exceptions** row in the block's property table.
2. Click the ... button to open the **Exceptions** dialog box.
3. From the list of events on the **Supported** pane, select an event that you want to rearrange.
4. Do one of the following:

- To move the event higher in the sequence, click the **Up** button.
- To move the event lower in the sequence, click the **Down** button.

Notes:

- Each block has its own predefined set of events on the **Exceptions** property dialog box. Genesys recommends that you not remove any of the predefined events from the **Supported** list.
- Before generating code, each supported event must be handled by connecting its red node on the side of the block to the inport (input node) of another block.
- The events in the **Entry block** are global in scope.
- Events defined in other blocks are local to that block only. When an event is thrown, if a handler for that event is declared in the current block, that local event handler is called.
- If there is no local event handler for the event, but there is a global event handler declared in the Entry block, then the global event handler from the Entry block is called.

Condition Property

The Condition property indicates that the log will be active only if the given condition is true at runtime. To provide a condition setting for a log:

1. Select the **Condition** row in the block's property table.
2. Type the condition to evaluate against.

For example, assume in Entry block, there is a variable "MyVar==3. Assume also that you would like to log the session ID (GVPSessionID variable in Entry block) for all sessions where MyVar=3. In this case you must set the condition to "AppState.MyVar=3". If this condition is true, then GVPSessionID will be written to the log, otherwise it will be ignored.

Enable Status Property

This property controls whether or not a block contributes code to the application. Diagrams visually indicate when a block is disabled. You may wish to use this property if there is a need to temporarily remove a block during debugging or, for other reasons during development, temporarily disable a block. This saves the effort of having to remove the block and then add it back later. You can also right-click a block and select **Toggle Enable Status**. The GVP Debugger skips over deactivated blocks.

Logging Details Property

Logging details contains the expression that will be logged at runtime by GVP. If logging details are specified, then logging is generated for the block; if no logging details are specified, no logging is generated. To create logging details:

1. Click the **Logging Details** row in the block's property table.
2. Click the ... button to open the **Logging Details** dialog box.
3. In the **Logging Details** dialog box, click **Add** to open [Expression Builder](#).
4. Create an expression to be used for logging details, such as an expression based on the variables whose content you wish to log.

Log Level Property

To assign a value to the Log Level property:

1. Select the **Log Level** row in the block's property table.
2. In the **Value** field, select one of the following from the drop-down list:
 - **Project Default.** The block uses the project's default log level, which can be configured through the [Project properties](#).
 - **Info.** This is an Informational level to log application-specific data.
 - **Debug.** This is a Debug level used for application debugging.
 - **Error.** This is an Error level to log error details.
 - **Warn.** This is a Warning level to flag any application warnings.
 - **Alarm.** This is an Alarm level to send the message as an alarm to the Genesys management framework.

Prompts Property

Use the Prompts property to specify the audio prompts that are played to the caller. You can specify pre-recorded prompts, text, video, and several standard data types. SSML tags can be used inline in TTS prompts. For example:

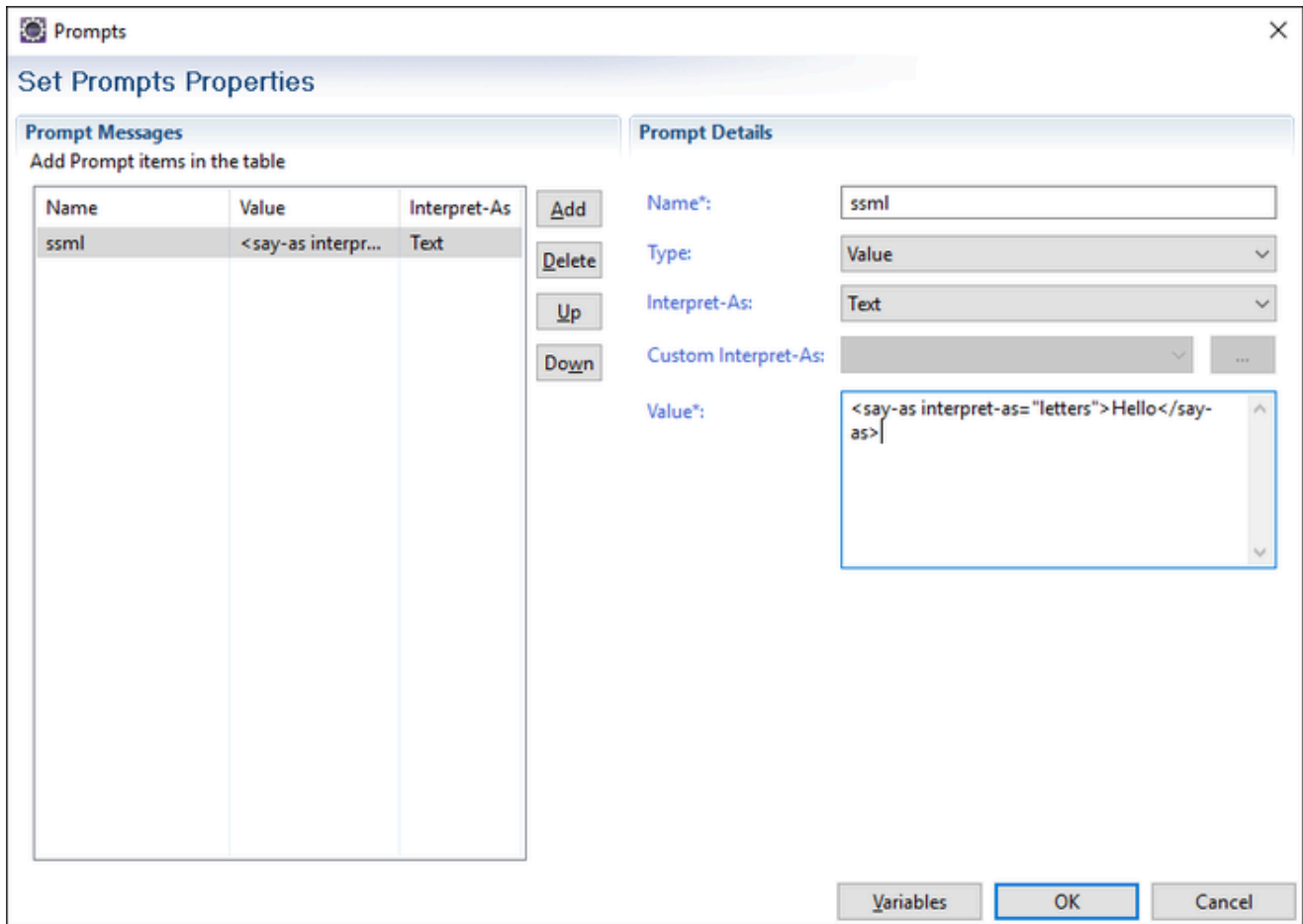

The example below shows the dialog box opening from the Prompts property when **Type** is **Resource**.

Prompt Messages
Add Prompt items in the table

Name	Value	Interpr...
Prompt1_Pr...	Prompt D...	Text

Prompt Details

Name*: Prompt1_PromptMsg1

Type: Resource

Interpret-As: Audio

Value:

Show All Files

Alternate Text:

Text Overlay Enable Text Overlay

To add, delete, or arrange prompts:

1. Click the **Prompts** row in the block's property table.
2. Click the ... button to open the **Set Prompts Properties** dialog box.

Set Prompt Properties Dialog Box

Prompt Messages Area

- **Name**--Displays the name of the prompt based on what you enter under the **Prompt Details** area.
- **Value***--Displays the prompt's value based on what you enter in the **Prompts Details** area.

- **Interpret-As**--Displays the data type of the prompt. The table below details available selections.

Prompt Details Area

Type--Displays whether the prompt is **ARM**, **Resource**, **Value**, or **Variable** based on what you enter under the **Prompt Details** area. Note that when **Type** is **Variable**, the runtime values of the specified variable should be of type string. Numerical values should be quoted, e.g. when assigning a value using the Assign block, or during a debugging session.

Type/Interpret-As Combinations When **Type** is set to **Value** and

- Interpret-As is set to **Time**, you can select the **Time Format** in the drop-down list. The time format is displayed in 12-hour mode (1:00 PM, 2:00 PM, and so on), or 24-hour mode (13:00, 14:00, and so on).
- Interpret-As is set to **Audio**, you can specify an HTTP or RTSP URL.
- Starting with 8.1.410.14, a new Phone option is introduced in the **Interpret-As** input list when **Type** is set to **Value** or **Variable** is selected. If the phone option is selected, the Value/Variable is spoken in the following manner: If a 10-digit number, the phone number is spoken out in a group, like 3 digits - 3 digits - 4 digits - with 350 milliseconds pause between the groups. If there is an extension number, the number is spoken out separately. For example, a phone with extension: 6507124455x5645. If a 7-digit number, the phone number is spoken out in a group like 3 digits - 4 digits - with 350 milliseconds pause between them. If other than 10 and 7-digit numbers, the numbers are spoken out as normal alphanumeric prompts.

When Type is set to **Variable** and **Interpret-as** is set to **Custom**, a **Custom-Interpret As** field is enabled, which can be used for custom prompt types as detailed in the table below. When Type is set to **Resource** and **Interpret-As** is set to **Audio**, the **Alternate Text** field is displayed. This text is played back to you in the event that the audio file is not available. When Type is set to **ARM** and **Interpret-As** is set to **Audio**, you can specify a base URL, audio resource ID, and personality ID. These can be used for managing audio resources in the arm (Audio Resource Management (ARM)) section of the [Genesys Administrator](#) Extension Server Application object. When Type is set to **Variable** and **Interpret-As** is set to **Audio**, you can specify a variable that contains an HTTP or RTSP URL. This applies to the [Prompts](#), [DB Prompt](#), [Input](#), [Menu](#), and [Record](#) blocks. **Add Button** Use the **Add** button to enter prompt details.

1. Click **Add** to enable the fields.
2. In the **Name** box, accept the default name or change it.
3. From the **Type** drop-down list, select **ARM**, **Resource**, **Value**, or **Variable**.
4. In the **Interpret-As** drop-down list, select from among the data types shown in the following table:

<p>AUDIO</p>	<p>Plays an audio sound file.</p> <p>Notes: If you select Audio, an audio file is optional, and you select the audio file if needed using the Browse button. Use the Clear button to remove an audio resource file selection. You can then specify an audio resource URL through Expression Builder, an audio resource identifier, personality identifier, and audio format. When you select ARM from the Type dropdown list, Interpret-As defaults to Audio. The VOXFILEDIR variable in the Entry block defines the audio file directory. For more information, see the Entry block help. You can also specify an alternative text for the audio file. This alternative text is played back to you in the event that the audio file is not available or is</p>
---------------------	--

	not provided. Typically, you can use this option during development, when the production audio files are not recorded yet.
BOOKMARK	An indicator that sets the place in a sequence of prompts. It can be used to detect the barge-in position during playback of a prompt. It uses the TTS engine.
CURRENCY	<p>An optional currency specifier followed by a number with at most two decimal places. The currency specifier can be:</p> <ul style="list-style-type: none"> • \$, British pound sign, yen sign, or Euro sign, OR • 3-character ISO4217 currency code <p>In the U.S. English locale, 11234 would be spoken as "eleven thousand, two hundred and thirty-four dollars."</p>
DTMF	<p>Plays DTMF tones.</p> <p>Any string of numerical digits, the characters a to d, #, or *</p>
DATE	<p>Speaks the specified date.</p> <p>yyyyMMdd, e.g. 20080604</p> <p>Note: If you select the DATE type, click the drop-down arrow to display a calendar from which you can select the date. You can select the format as Long Date or Short Date in the Format drop-down list. If you select Long Date, the month, day, year, and day of the week will be voiced out from the given value. For example, if user provides 20200226, <i>Wednesday February Twenty Six, Two Thousand and Twenty</i> is voiced out by the system. If you select Short Date, the month and year will be voiced out from the given value. For example, if user provides 20200226, <i>February Two Thousand and Twenty</i> is voiced out by the system.</p>
NUMBER	<p>Speaks a number. For example, 1234 would be spoken as "one thousand, two hundred, thirty-four."</p> <p>Any integer (no decimals)</p>
ORDINAL	<p>Speaks the number as an ordinal. For example, 1 would be spoken as "first."</p> <p>Any integer (no decimals)</p>
STRING	<p>Speaks a string of letters or numbers one character at a time. For example, 1234 would be spoken as "one, two, three, four."</p> <p>Note: The STRING type for U.S. English local accepts 0-9, A-Z, and +<=%->&.#*#@. All other locales accept only 0-9 and A-Z.</p>
TEXT	Plays the specified text with text-to-speech software
TIME	Speaks the specified time.

	<p>hhmm[ss][?hap] (seconds is optional, and format specifier is optional) The format specifiers mean the following: ? -- neither am or pm, e.g. two o'clock or two fifteen h -- 24-hour clock, e.g. fourteen hundred hours or fourteen fifteen a -- AM, e.g. two AM or two fifteen AM p -- PM, e.g. two PM or two fifteen PM If no format specifier is given, it defaults to ?, i.e. am/pm is unknown. Note: 12 hour time selection will show the Time value in 24 Hr format in the Prompt Message Table. (e.g. 1:45:39 PM will be shown as 134539) whereas it will work as expected in the generated code to read the value in 12 hour format during runtime. You can select the format as 12-Hour or 24-Hour in the Format drop-down list. If you select the 12-Hour format, the given time is voiced out in the 12-Hour format. For example, 052254p is voiced out by the system as <i>five twenty two PM and fifty four seconds</i>. If you select the 24-Hour format, the given time is voiced out in the 24-Hour format. For example, 172254 is voiced out by the system as <i>seventeen twenty two and fifty four seconds</i>.</p>
<p>VIDEO</p>	<p>Use to allow VoiceXML to insert text into an existing video image/stream.</p> <p>If Video is selected, you can check the Enable Text Overlay box.</p> <ul style="list-style-type: none"> • Click the Fx button to open the Video Text Overlay dialog box. • Click Add to specify: text (required), font name, font style, font color, background color, font size, font width, X axis offset, and Y axis offset.
<p>CUSTOM</p>	<p>This Interpret-As option can be used to define Custom Prompts to customize the Prompt reading functions. To define a Custom Prompt:</p> <ul style="list-style-type: none"> • Open the predefined <code>customprompts.js</code> file inside each language locale folder applicable for the Project. (<code>Resource\Prompts\\${Language\$}</code>). • Use the <code>customprompts.js</code> file present inside to define custom prompt methods. • Refer to the syntax and rules mentioned in the default <code>customprompts.js</code> file inside <code>./Resources/Prompts/en-US</code> folder. • Start each Custom Prompts methods with the language locale name to achieve Multilingual support during runtime execution (mandatory). <p>The Prompts property dialog will only parse methods defined in the <code>customprompts.js</code> file. During design time, the default language locale <code>customprompts.js</code> file is parsed and listed for method selection. During the runtime call, the <code>APP_LANGUAGE</code> variable value is</p>

	<p>used to dynamically select the language local folder.</p> <ul style="list-style-type: none"> • Use 'audio' option to play audio files in the Custom Prompts methods using <audio> tag and 'value' option to play expressions using <value> tag.
--	---

5. In the **Value** box, enter data for the selected data type.

Place the audio files in the Resources\Prompts\{APP_LANGUAGE} folder under the Java Composer Project. Audio files can be added to the project by copying and pasting from the Windows file system into the Java Composer Project in the Project Explorer. Note: By default, Genesys supplies .vox files only for mulaw 8Khz. If you are using any other audio format for playback of audio files, replace the files with the corresponding audio files in the required audio format. **Up/Down Buttons** Use the **Up** and **Down** buttons to reorder your prompt elements. Select the element you want to re-position, and then click **Up** or **Down**, as necessary. **Delete Button** To delete a prompt:

1. Select an entry from the list.
2. Click **Delete**.

This property is used in the following blocks: **Prompt Block**, **Menu Block**, **Input Block**, **Record Block**

Retry Prompts Property

The Retry Prompts property in a **Menu block**, **Input block**, or **Record block** enables you to set different retry prompts that are played to the caller when the voice application encounters a nomatch or noinput condition. You are allowed up to three retries for either a **noinput** or a **nomatch** error condition. You must select the listed items in sequence and add the necessary vox file or text input. To set retry prompt properties:

1. Click the **Retry Prompts** row in the block's property table.
2. Click the ... button to open the **Retry Prompts** dialog box.

Note: You must set the **Number Of Retries Allowed** property to a value greater than 0 in order to have access to the **Retry Prompts** dialog box. **Prompts Fields**

- Name-- Displays the name of the retry prompt.
- Type--Displays whether the retry prompt is a **Resource**, **Value**, or **Variable**.
- Interpret-As-- Displays the data type of the retry prompt.
- Alternate Text--(Enabled only when Interpret-As is set to **Audio**.) This alternative text is played back to you in the event that the audio file is not available.
- Value*--Displays the retry prompt's value (Retry Prompt).

Note: When **Interpret-As** is set to **Time**, you can select the **Time Format** in the drop-down list. The

time format is displayed in 12-hour mode (1:00 PM, 2:00 PM, and so on), or 24-hour mode (13:00, 14:00, and so on).

Retry Prompt Messages Property

For Input and Menu Blocks:

After setting a value for the **Number Of Retries Allowed** property, **Retry Prompt Messages** will contain one noinput and one nomatch entry per retry. For example, if **Number Of Retries Allowed** is set to 2, the **Retry Prompt Messages** table contains the following entries: noinput1 nomatch1 noinput2 nomatch2

For Record Blocks:

Retry Prompt Messages will contain one noinput entry by default. To set or change retry prompt properties:

1. Select a retry prompt in the **Retry Prompt Messages** table to enable **Prompt Details** fields.
2. In the **Name** box, accept the default name or change it.
3. From the **Type** drop-down list, select **Resource**, **Value**, or **Variable**.
4. In the **Interpret-As** drop-down list, select from among the data types shown in the following table:

AUDIO	<p>Plays an audio sound file. This is available only when Resource or Variable is selected as the Type.</p> <p>Note: If you select Audio, an audio file is optional, and you select the audio file if needed using the Browse button. Use the Clear button to remove an audio resource file selection. The VOXFILEDIR variable in the Entry block defines the audio file directory. For more information, see the Entry block help. You can also specify an alternative text for the audio file. This alternative text is played back to you in the event that the audio file is not available or is not provided. Typically, you can use this option during development, when the production audio files are not recorded yet.</p>
BOOKMARK	<p>An indicator that sets the place in a sequence of prompts. It can be used to detect the barge-in position during playback of a prompt. It uses the TTS engine.</p>
CURRENCY	<p>An optional currency specifier followed by a number with at most two decimal places. The currency specifier can be:</p> <ul style="list-style-type: none"> • \$, British pound sign, yen sign, or Euro sign, OR • 3-character ISO4217 currency code <p>In the U.S. English locale, 11234 would be spoken as "eleven thousand, two hundred and thirty-four dollars."</p>

DATE	Speaks the specified date. yyyyMMdd, e.g. 20080604 Note: If you select the DATE type, click the drop-down arrow to display a calendar from which you can select the date.
DTMF	Plays DTMF tones. Any string of numerical digits, the characters a to d, #, or *
NUMBER	Speaks a number. For example, 1234 would be spoken as "one thousand, two hundred, thirty-four." Any integer (no decimals)
ORDINAL	Speaks the number as an ordinal. For example, 1 would be spoken as "first." Any integer (no decimals)
STRING	Speaks a string of letters or numbers one character at a time. For example, 1234 would be spoken as "one, two, three, four." Note: The STRING type for U.S. English local accepts 0-9, A-Z, and +<=%->&.#*@. All other locales accept only 0-9 and A-Z.
TEXT	Plays the specified text with text-to-speech software
TIME	Speaks the specified time. hhmm[ss][?hap] (seconds is optional, and format specifier is optional) The format specifiers mean the following: ? -- neither am or pm, e.g. two o'clock or two fifteen h -- 24-hour clock, e.g. fourteen hundred hours or fourteen fifteen a -- AM, e.g. two AM or two fifteen AM p -- PM, e.g. two PM or two fifteen PM If no format specifier is given, it defaults to ?, i.e. am/pm is unknown. Note: 12 hour time selection will show the Time value in 24 Hr format in the Prompt Message table. (e.g. 1:45:39 PM will be shown as 134539) whereas it will work as expected in the generated code to read the value in 12 hour format during runtime.

5. In the **Value** box, enter data for the selected data type, or keep the default value of **Retry Prompt**.

See [template samples](#) that use the Menu or Input blocks.

Routing Applications and Workflows

This section introduces routing applications and workflows and summarizes how to create them.

Introduction to Routing Applications and Workflows

- [Workflow Post Installation](#)
- [IRD Functionality Included in Composer](#)
- [Frequently Asked Questions](#)
- [Upgrading Workflows](#)
- [Getting Started with Routing Applications](#)
- [Creating Routing Applications](#)
- [ORSOptions](#)

Routing FAQs

Genesys Routing Frequently Asked Questions

Related Topics

- [Composer 8.1.4 Deployment Guide](#)
- [Composer 8.1.4 Help](#)

This page provides answers to common questions that IT personnel might have when planning or considering the addition of Genesys Routing to their site. The information on this page applies to 8.1.x versions of Composer.

What is Genesys Customer Experience Routing and how is it unique?

Genesys Customer Experience Routing is computer software that helps organizations better manage customer journeys. Routing prioritizes and matches the right interaction with the right resource at the right time. Our approach is unique in the industry because it's:

- SIMPLE to support the 80% of customer interactions that are routine
- DYNAMIC to automatically adapt to fluctuations within the 80% (so this variability doesn't consume 100% of resources)
- POWERFUL to drive the 20% of interactions that are not routine but are the most valuable (across time, channels, multimedia, front and back office)

We help companies create better customer experiences. Our DYNAMIC routing frees you to do more than just what is SIMPLE. And that gives you bandwidth to apply the full POWER of Genesys to those moments that truly matter.

What is a routing application? What are the basic elements?

Routing provides instructions about how to handle and where to direct interactions under different circumstances.

Conceptually, a routing application is like a series of prioritized instructions that take into account various factors to determine the optimal routing target, and what to do next if that action is not possible within the specified constraints.

Routing applications are made up of a number of different elements, described here at a conceptual level:

- Data can come from various sources and may include customer, contextual, operational, or analytical data. Attached Data, which is included in call messaging as Key Value Pairs (KVPs), is what you know about a specific interaction. Attached data can be added and updated throughout the life of the interaction (e.g., as a call flows through the IVR, routing, agent desktop, and reporting).
- Skills are what you know about an agent. To identify the best available resource to handle a particular interaction, routing looks for desired combinations of Skills at the individual level (per agent), at the team level (per skill group, or queue'), or across a virtual pool of resources (virtual queue').

Skills should not represent absolutely everything about agents, but simply the minimum needed to accurately route and report on interactions. Because of the combinatorial power of Skills, it is best not to get too granular. Modify an agent's Skills only when the agent acquires new job functions, training, or capabilities; do not change agents' skills merely to redirect traffic.

Each Skill can optionally have a Proficiency (Rating in [Genesys Administrator](#)), which rates an agent's expertise for a particular Skill (e.g., Spanish level 5 vs. 10). This allows an organization to route to the best-skilled available agent, and then if no agents at that proficiency level are available within a certain amount of time, expand the target to agents with a lower proficiency level and/or an alternative combination of skills.

Logic provides the overall routing decisioning or instructions. Logic specifies the conditions under which the routing applies and the method of target selection. The logic can be based on a number of different considerations, such as skill targeting, service level, load balancing, percentage allocation, statistics, or workforce. (See below for more details.)

Certain aspects of routing can be configured and saved as Reusable Objects. There are various types of reusable objects, including subroutines, list objects, interaction data, etc. Reusing these building blocks within and across routing applications improves the efficiency, quality, and simplicity of the routing.

A well designed and implemented routing solution should be able to handle most of the ongoing routing needs in a dynamic and automated fashion. However, there may be some situations where the business needs or wants to make changes on a frequent or ongoing basis. These select elements can be exposed to business users either as Operational Parameters or as [Genesys Rules](#) to facilitate greater business agility while maintaining system stability:

- Operational Parameters are simple conditional variables that give business users limited control (e.g., After Hour Messages, Hours of Operation, Emergency Status, etc.). Users can make changes to these parameter settings through the [Genesys Administrator Extensions](#) (GAX) interface. (Alternatively, this can also be done via list objects in Interaction Routing Designer (IRD).) The business user cannot change the underlying logic (only the pre-specified values of the exposed parameters), and does not require any specialized technical training.
- [Genesys Rules](#) are logical representations of underlying routing that are written in plain language (i.e., meta-language, not code). They are useful when the business user (typically a business analyst) wants greater control over the conditions, logic, and actions associated with the routing (e.g., create differentiated customer service treatments based on segmentation, marketing campaigns, etc.). Users can make updates to the business rules, but only for those parts of the routing that have been exposed through the business user interface within Genesys Conversation Manager. Although the business user

isn't actually viewing or changing the code directly, they still require a clear understanding of the business logic and potential impact of changes.

What are some of the most common types of routing?

The table below lists the most common types of routing.

TYPE	DESCRIPTION
Agent Group	sRouting interactions to a specified group of agents. This may be based on job type (e.g., Tier1Agents), location or site (e.g., MiamiAgents), etc.
Auto Attendant	Routing implemented to support simple menus (e.g., audio prompts and touchtone selections), mimicking the functionality of a basic IVR.
Blended	Routing which allows the same agent or select resources to handle more than one type of interaction (e.g., Inbound/Outbound, multimedia). Blending should be used to make use of underutilized resources and to prevent service level fluctuations (e.g., forcing agents to log off a voice queue due to an influx of Social Media interactions). Consider how many interactions of each type an agent can handle at a time and define capacity rules according. Also, increment and/or cap priority values based on interaction types, so voice interactions don't always take precedence over non-voice ones, or vice-versa.
Business Case	Routing to provide differentiated customer service treatments for specific business processes or use cases (e.g., marketing campaigns, account status, payment due, collections, regulatory, etc.).
Callbacks/Virtual Hold	Routing that accounts for the prioritization and targeting when a call back to a customer is required, requested, or scheduled.
Cascading Routing	Routing that uses multiple tiers of prioritized routing decisioning, such that if the conditions for the highest priority routing instructions are not met, the routing automatically overflows to the next level of routing instructions. Conditions can also be checked in parallel, so that time is not wasted waiting to execute the first tier of decisioning before considering the next one.
Concierge Routing/Hunt Groups	Routing to a specific agent or a small group of individuals when specialized or personalized service is required. Typically the interaction is first directed to the primary agent assigned to a particular customer account. However, if that agent is unavailable, the routing will search for the next available team member within a small hunt group.

Cross-Channel	Routing based on what a customer was just doing on another channel (e.g., a customer is on the company's website or mobile application and then calls in).
Default Routing	Routing an interaction to the default destination that is to be used when none of the conditions for the previous tiers of routing decisioning have been met. This typically occurs when traffic volumes spike for some reason and the timeout thresholds for the previous tiers have been exceeded, so the interaction overflows to the final default destination.
Dynamic Routing	Routing that automatically adjusts based on pre-specified priorities and conditions. Examples include: cascading routing, target expansion, timeout thresholds, data dips, holidays, emergencies, service outages, etc. Dynamic routing is an efficient and valuable alternative to reskilling agents on the fly, an inefficient and costly practice that is often used in legacy contact center environments to manually redirect traffic.
Enterprise Workload Management	Routing of work items across the enterprise. The same Genesys routing capabilities that can be used to direct customer-facing interactions (calls, emails, chat, etc.) can also be leveraged to schedule, assign, distribute and track work activities across the back-office.
Escalations	Routing of interactions which require the support or intervention of a more highly skilled agent (e.g., 'Tier 2') or manager. This may be handled as a transfer, or it may involve a conference call or consultative support with the specialist.
eServices/Multimedia	Routing of various types of non-voice interactions (e.g., email, chat, text, social, video, open media). Different media types may require unique skills (e.g., +Written could be a skill type for email, chat, and text). Consider how many interactions of each type an agent can handle at a time and define capacity rules according (e.g., 1-4 chats per agent).
Interaction Type (a.k.a. Call Type)	Routing based on the type of customer and/or customer's intent. This is typically determined based on the number dialed (DNIS), from the caller's menu selection or activity within the IVR, or from content analysis on an email or chat.
Interactive Voice Response Integration	Routing a call to the appropriate target based on what the caller did or selected within an IVR. Based on integration with Genesys Voice Platform (GVP) or a third-party IVR.
Last Agent Routing	Routing to the last agent the customer interacted with. Especially useful for routing to a single point of contact (such as a case owner) or for dropped calls that call back in within a specified timeframe.

Outbound	Routing of interactions that are initiated by the organization and directed outward to the customer (e.g., outbound calls, marketing campaigns, collections, outbound emails, text messaging, proactive contacts, etc.).
Overflow/Sharing Agents	Routing to an alternative queue or agent group, when the primary target is unavailable or over-utilized. Lending and borrowing of resources can be contingent upon certain predetermined business conditions being met, so that spikes in one team's volume does not unduly impact another team's availability or service levels.
Percentage Allocation	Distributing interactions between queues based on a percentage of total volumes (e.g., 60% to Site A and 40% to Site B).
Priority Queuing	Routing which uses priority values to give preference for one queue or interaction over another. Priorities can be incremented over time, so if a lower-ranked interaction has been waiting longer, it will be serviced before a higher-ranked interaction that has just arrived. This ensures that no interaction ever waits too long for service.
Queue Treatments	Routing that plays audio (e.g., music, ads, messages) or provides certain functionality while callers are waiting in queue or on hold.
Ring No Answer/Redirect on No Answer (RONA)	Routing to an alternative target if the original target fails to answer (e.g., agent failed to log out). The agent will be targeted the first time, but after that an action can be specified (e.g., log out) so that agent isn't targeted again subsequently.
Segmentation	Routing based on the type of customer, the value of the opportunity, or other marketing segmentation data.
Skills-Based	Routing to the best-skilled available agent based on a combination of skills specified in the routing. This is sometimes called 'agent-level routing,' since Genesys routing is capable of looking down to an individual agent's unique set of skills. However, in practice routing typically looks for the desired skill set across a 'universal queue,' to optimize utilization across a large pool of resources.
Statistical Routing	Routing based on various database lookups and operational conditions, such as Estimated Wait Time (EWT), queue depth, service levels (SLAs), performance goals, agent occupancy, skill utilization, seasonality, special events, business processes, etc.
Target Expansion	Routing that expands its targets to increase the pool of agents able to handle an interaction, be it after a time period or triggered by the Estimated Wait Time (EWT) being greater than a defined threshold. The highest skill level is first targeted until the time limit is reached, and then routing

	expands to include the next level of skills, cascading down until all skill levels are included in the targeting. This ensures that if the best suited pool of agents are unavailable, then after the expansion timeout the next best pool of agents are included in the targeting.
Transfers	Routing to handle transfers. Need to consider the routing for transfers that are directed either into or out of the contact center. The routing priority may vary depending on whether it is an internal transfer (within the contact center) or external transfer (to/from an outside group or entity).
Workforce	Routing that factors in various workforce considerations such as schedules, shrinkage, absenteeism, training, skill development, desktop/tools, new-hires/career paths, agent affinity for particular interactions, outsourcers, unions, labor laws, etc.
Voicemail	Routing of inbound calls to voicemail (e.g., after hours group voicemail inboxes). Or outbound routing which addresses what to do if a voicemail is reached (i.e., leave a message or not).

How many skills total does an organization typically have?

It depends on the size and requirements of the organization, but generally we see a range somewhere between 20-75 skills total. Once you start to approach 100 or more skills, you need to question if you are really taking advantage of the combinatorial power of Genesys skills (i.e., where agents can be multi-skilled and Genesys routing can look for multiple combinations of skills).

The average agent is typically highly proficient in 3-4 skills each, but may have lower proficiency in other skills to provide backup. Expert agents may be highly proficient in 10 or more skills.

Skills and proficiencies grow and change over time, which is useful for staff development and retention. Skills need to be monitored and aligned across staffing and routing.

If you find there are certain skills – a, b, c – that every agent has, then maybe you've dissected the skills too granularly. Try renaming/regrouping these into one mega-skill (e.g., A). At the same time, you don't want to group so many skills together that you've gone back to queue-based routing, where each skill maps to a separate queue.

If an organization requires many skills, rather than hard-coding each one separately directly into the routing logic, a better and simpler approach may be to reference the skills as variables within the routing logic. Then do a data-dip into a database or table look-up from a separate file. That way when skills need to be modified, this can be done in the external data source housing the skill information, without having to change the actual routing logic itself. Soft-coding skills is an effective approach if you find that skills change frequently over time, but the core routing does not. Certain industries demand a high level of subject matter expertise (e.g., finance, insurance, healthcare), so there are more total skills the organization needs. At the same time, since each agent requires more specialized expertise to handle these inquiries, each agent typically handles fewer call types than in other industries where agents may be more of generalists.

Don't confuse Skills with Attached Data. For instance, consider situations in which many corporate clients need to be supported, or there are state-specific licensing requirements (e.g., 401ks, insurance plans). The specific account or plan can be identified based on the phone number dialed (DNIS) or other information gathered in the IVR and attached to the call. There may be hundreds of these possibilities. However, this doesn't necessarily mean there need to be hundreds of different skills corresponding to each. An individual agent might be trained to handle a more generalized skill (e.g., 401Ks in general), and a particular plan's specifics can be screen-popped through to the agent's desktop based on the Attached Data.

How many routing applications should an organization have?

As a rule of thumb, a large contact center solution (a major line of business) should not need more than 10 routing applications and subroutines (not counting reusable objects and subroutines used across applications).

It's important to encompass two key design considerations when planning routing – Flexibility and Simplicity. This can be done by creating generic components and modularizing parts for reuse. A routing model which is data-driven and accommodates the logic shared across applications and lines of business helps to eliminate duplicated logic or code. Functionality which is replicated should be separated out into a sub-routine to minimize the need to change multiple applications for feature enhancements and/or defect fixes. This minimizes the number of applications required and still meets the demands of complex routing requirements.

What are skill proficiency levels, and what are they used for?

Proficiency is an optional way of reflecting how relatively good an agent is at a particular skill (e.g., Spanish level 5 vs. 10). Following the 'Simplicity' design principle, it's best to keep to three (or fewer) levels of skill proficiencies – for instance, High = 9, Medium = 6, and Low = 3. This allows additional proficiency levels to be added in between if required in the future.

Proficiency enables Target Expansion – e.g., first target agents with skill of Sales ≥ 9 proficiency for 15 seconds, then target Sales ≥ 6 for 15 seconds; then target Sales > 0). This circumvents agents having to log off one agent group/queue and log into another, which is a common issue with legacy ACD-based solutions and can be avoided using Genesys routing.

How many tiers of cascading routing should there be?

With basic Skills-Based Routing, 4 tiers are typical – 3 for the three skill proficiencies and the fourth tier for emergency (e.g., breached threshold, all agents log off).

When using additional soft skills to provide an extra level of customer experience, then an additional tier will be required before the 4 tiers previously mentioned.

What Reporting considerations need to be taken into account?

First, the Reporting requirements need to be well defined. What are the business goals of the solution? How will success be measured? What are the KPIs? How does the business need to slice and dice the data? How will reporting be represented? What needs to be monitored in near real-time vs. historically? Who are the different consumers of reporting and what do they want/need to see? What business intelligence is needed – analytics, trends, outliers, outcomes, actionable insights, alerts?

Routing must then be aligned with those Reporting needs. This is typically supported through Attached Data associated with each interaction (e.g., line of business, customer segment, routing point/agent, service type, disposition code, business result, etc.). Decide on a flexible approach for attaching data. Don't attach too much (as it may have a performance impact). Consider codifying values to reduce the total data overhead. And be very clear about what data represents at the point it was attached.

What Workforce Management considerations need to be taken into account?

Genesys routing allows an interaction to be serviced by the best-skilled available agent across a virtualized pool of resources, and to expand the target (to lower proficiency level and/or a different skill set) if the desired target isn't available. Altering the original target (such as in target expansion) will always affect Workforce Management (WFM), so it's important to include WFM into the routing considerations.

- For instance, sometimes an agent might be working on a call type that is outside of what they normally work on. So supervisors/team leads need the right insight to know their people are working on the right thing at the right time.

Genesys Routing works with a variety of industry WFM solutions, but there are additional advantages to using Genesys Workforce Management:

- The Genesys WFM solution provides historical data collection and real-time analytics for all interaction types being monitored by the Genesys environment.
- Genesys WFM integrates with the Genesys suite to utilize all of the Site, Agent, Skill, and Skill level information contained therein.
- Genesys also provides the ability to base routing on agents' specific future schedule states in Genesys WFM. For instance, if an agent is scheduled to go on break soon, routing will not direct an interaction to them, to stay in adherence.

Skills should not be changed to re-route traffic, due to absenteeism or overflow.

- Frequent ad hoc re-skilling of agents (to redirect traffic flow) is inefficient, fails to leverage dynamic routing, and can wreak havoc with the accuracy of WFM forecasting for skill types.
- Agents should already have their skills and proficiencies in their profiles, but they may be scheduled to take particular call types based on their scheduling and routing logic. Re-skilling of agents typically only happens if they have acquired new skills (after training) or taken on a new job role.

- Most interaction flows should be handled via dynamic routing (such as target expansion). If traffic must be manually redirected, then rather than re-skilling agents, keep agent skills the same and redefine the 'activity set' object within Genesys WFM. This reschedules agents to work on different activities during a given time period. That way you are rescheduling the types of work they are handling, rather than changing the agents' actual skills. This approach is based on doing schedule-based routing (not just skills-based routing), and has a dependency on Genesys WFM, thus taking advantage of the interoperability across the Genesys suite of solutions.

What are the best practices for migrating from traditional queue-based routing to Genesys Customer Experience Routing?

The most common mistake that organizations make when moving away from legacy ACD environments is trying to replicate a like-for-like solution. While this is sometimes inescapable as an interim step (e.g., due to end-of-life equipment), it should be avoided at all costs as the end state. Seize the opportunity to re-evaluate your current customer experience and create an optimal solution:

- Start by identifying the business goals and customer experiences you want to deliver.
- Segment your customers and determine an appropriate customer service strategy for each (e.g., Elite Customers, High Value, Mass Market, and Low Value).
- Consider the various channels and contact drivers of customer interactions. Rather than treating these as siloed touch points, craft them into seamless customer journeys. (These journeys will likely vary per segment.)
- Evaluate your workforce and identify their hard and soft skills. Determine which skill sets and proficiencies are needed to deliver the desired customer journeys. Are there gaps? Do job roles, teams, or training need to change?
- Prioritize (rank) desired customer journeys and match with optimal skill targets for each. Then consider the next best treatment and target if these conditions cannot be met.

As a rule of thumb, routing should be designed so that:

- Your most valuable customer interactions (top 10-20%) receive the best service most of the time.
- The majority of your customer interactions (60-80%) receive good service (e.g., slightly longer wait, less skilled agents) much of the time.
- Your costly customer interactions, overflows, or exceptional situations (bottom 5-20%) receive adequate service and the minority of the time.

Getting Started with Route Applications

The information in this book will help you get started using Composer to build SCXML-based strategies (hereafter called routing applications) which can be comprised of one or more [workflows](#). It assumes you have reviewed the topics in the general [Getting Started with Composer](#) section.

Preparation

Composer provides a wide range of tools to satisfy the needs of a diverse developer population. Ideally, you will be already be familiar with SCXML, XML, and HTML. If you do not wish to write code or use existing code templates, you can build routing workflows using Composer's designer where you place, configure, and connect routing blocks.

- [View the samples](#)
- [Set preferences](#)
- [Review the blocks for routing applications](#)
- [Review the Quick Start topic](#)

Get Started

- [Create a new routing Project](#)
- [If routing multimedia interactions, review IPD planning & preparation.](#)

IRD Functionality Included in Composer

Composer enables you to create SCXML-based routing applications to run on the Universal Routing 8.x platforms and, as such, it includes functionality that was previously provided through Genesys **Interaction Routing Designer** (IRD). The information below is provided for existing Genesys customers transitioning to Composer, who are familiar with creating strategies in IRD.

Composer Blocks and IRD Objects

Composer refers to the fundamental element of a workflow as a *block*; whereas in IRD documentation, this element is referred to as an *object*. The tables below group IRD objects based on their IRD toolbar category name and point to the corresponding functionality in this release of Composer. Summary information is presented below.

- Learn about the **differences** between Composer and Interaction Routing Designer, which has historically been used to create routing applications.
- See the Composer **Quick Start** for how to create a simple routing strategy, attach data that will appear on the agent desktop, and route to the preferred agent.

Data & Services

IRD Object Name	Composer Block Name	Description
Database Wizard	DB Data	DB Data retrieves information from the database. Uses a Query Builder .
Web Service	Web Service	Invokes Web Services. GET, POST and SOAP over HTTPS are supported.
	Web Request	Invoke any supported HTTP web request or REST-style web Service. See sample: Routing Based on Web Request .

Also see Composer's **Server Side Blocks**.

Miscellaneous

IRD Object Name	Composer Block Name	Description
Assign	Assign	Assigns a computed value/ expression or a literal value to a

Multi-Assign		variable. Variables are defined in the Entry block. Capable of multiple assignments.
Call Subroutine	Subroutine	Creates reusable sub-modules.
Entry	Entry	Sets global error (exception) handlers. Defines global variables (see Variables section below).. All routing strategy diagrams must start with an Entry block.
Exit	Exit	Terminates the strategy and returns control back to calling workflow in case of a subroutine.
Error Segmentation	Multiple error output ports can be created in Composer blocks based on each block's Exception property.	
Function Multi-Function	ECMAScript	Builds an ECMAScript expression using the Expression Builder . Many URS functions are available as Genesys Functional Modules described the Orchestration Server Documentation Wiki can invoke multiple functions.
If	Assign, Branching, ECMAScript blocks all open Expression Builder	Expression Builder can be used to create IF expressions.
Multi-Attach	ECMAScript	Can be used for attaching data to an interaction.

Also see Composer's **Routing Flow Control Blocks**.

Routing

IRD Object Name	Composer Block Name	Description
Selection	Target	Routes an interaction to a target, which can be Agent, AgentGroup, ACDQueue, Place, PlaceGroup, RoutePoint, Skill, or Variable. Skill target uses Skill Expression Builder .
Percentage	Target	Statistics Order property in Target block, lets you perform percentage allocation. Also see sample: Routing Based on Percent Allocation .
Default	Default Route	Routes the interaction to the default destination. Can be

		overridden by the Set Default Route block.
Routing Rule		Orchestration Server 8.1 does not support service level routing rules.
Switch to Strategy		Orchestration Server 8.1 does not support switch to strategy routing rules.
Force Route	Force Route	Not exposed as a routing rule in Composer.
Statistics	Target	Although statistical routing rules are not yet supported as in IRD's Statistics routing object, users can use the Target object Statistic property to route based on the value of a statistic. A Statistics Manager and Builder let you create your own statistics from URS predefined statistics.

Also see Composer's **Routing Blocks**.

Segmentation

IRD Object Name	Composer Block Name	Description
ANI	Branching	See Your First Application: DNIS Routing for an example.
DNIS	Branching	See Your First Application: DNIS Routing for an example.
Date	Branching	See the sample Routing Based on Date & Time.
Day of Week	Branching	See the sample Routing Based on Date & Time.
Time	Branching	See the sample Routing Based on Date & Time.
Classification Segmentation	Branching	For classification segmentation, an ECMAScript function determines if a particular category name or ID exists in the array of category objects represented by an application variable.
Generic	Branching	Use as a decision point in a workflow. It enables you to specify multiple application routes based on a branching condition.

Also see:

Composer [Common Blocks](#)

[Context Services Blocks](#).

Voice Treatment

See [Composer Equivalent to IRD Treatment](#).

eServices Multimedia

See [Composer Equivalent to IRD Multimedia](#).

Outbound

See [Outbound Common Blocks](#)

Context Services

See [Context Services Blocks](#)

Business Process

See [Interaction Processing Diagrams Overview](#) and [Interaction Process Diagram Blocks](#). Reusable Objects

- IRD List Object: See Composer's [List Object Manager](#).
- IRD Variable List Dialog Box: See Entry block [Variables](#) property.

In contrast to IRD, which defines variables in a special dialog box outside of the strategy, Composer defines both [workflow](#) and [Project variables](#).

Workflow Post Installation

Workflow post installation steps are described below.

Tomcat

Important

Starting with Composer 8.1.561.35, only Tomcat 10.1.x are supported. Provide the Tomcat installed location and Composer installed location in Preferences. Use the button, **Update tomcat configuration** to switch between Tomcat versions and ports.

This step is necessary for both voice and routing applications. For Tomcat settings:

1. Select **Window > Preferences**, then expand **Composer** and select **Tomcat**. Starting with 8.1.420.14, Composer supports Tomcat 7. Composer installation adds the role for manager-gui to Tomcat configuration for callflows and workflows. The default username and password for the bundled Tomcat is admin. The username and password for manager-gui is tomcat.
2. Provide the same port number that you specified during installation. The default user name and password for the bundled Tomcat is admin.
3. To start Tomcat, click the  button on the main menu. If necessary, see [Tomcat Service Failed to Start](#).

If you already have Java Composer Projects in the workspace and did not perform the Tomcat configuration earlier, perform the following steps to deploy the project on Tomcat:

1. From the Project Explorer, right-click on the Java Composer Project and select **Properties**.
2. Select **Tomcat Deployment** and click the **Deploy** button.

Note: This also needs to be done if a Java Composer Project is imported or renamed as well.

Also see: [Configuring_Proxy_Settings_in_Tomcat](#).

Configuration_Server

Routing applications may be developed either:

- With a connection to Configuration Server
- Or in an offline mode, without connecting to Configuration Server

Whether or not to connect depends on what you wish to do. For example, you would need to connect to Configuration Server in order to access configuration objects through the **Target block**. You can connect to Configuration Server now or wait until strategy design time. To bring up the Connect Configuration Server dialog box:

1. From the main menu, select **Configuration Server > Connect**. Or select from the toolbar. Or use the keyboard shortcut: Alt+I+C. (To disconnect, keyboard shortcut is: Alt+I+D).
2. Enter **Username, Password, Application, Host,** and **Port** information for the Configuration Server used in your environment.
3. Enter the **Client Port Range**. When connecting to Configuration Server, Composer will attempt to find an unused client-side port within the specified range to establish the connection.
4. Select **Use Secure connection** for Transport Layer Security (TLS) when connecting to Configuration Server.
5. Click **Next:**
 - If authentication with the supplied User Name and Password is unsuccessful, Composer displays informational text in a Configuration Server Connection Error dialog box.
 - If a secure connection cannot be made, or if Transport Layer Security is not configured, a Configuration Server Connection Error dialog box appears.

In both of the above scenarios, click the **Details** button for more information.

1. Select the **Tenant**. For a single-tenant environment, select **Resources**.
2. Click **Finish**. Composer can now access Configuration Server data during validation (if configured to do so) and other operations.

Notes:

- You can configure an inactivity timeout for the connection to Configuration Server as well as the time for the timeout warning dialog. For information on these features, see the [Genesys Security Deployment Guide](#).
- For making live calls, you must manually configure the Routing Point in the Configuration Database as described in the chapter on creating SCXML-based strategies in the [Universal Routing 8.1 Deployment Guide](#). You must also configure other Universal Routing Server options as described in that guide.
- Routing applications are not stored in Configuration Server as in 7.x and earlier. They are stored in the [Workspace](#) that you specify.

MIME_Types

MIME (Multipurpose Internet Mail Extensions) refers to a common method for transmitting non-text files via Internet e-mail. By default the SCXML MIME type is already configured in the Tomcat server bundled with Composer. If you are using the Internet Information Services (IIS) Application Server to deploy SCXML strategies, add the following MIME type extensions through the IIS Manager of your webserver:

.json	text/json
.scxml	text/plain
.xml	text/xml

Predefined_Statistics

There is an option to control whether or not to create Universal Routing Server predefined statistics. You will want to do this if you plan to **route based on the value of a statistic** (for example, statistic StatTimeInReadyState).

1. Select **Window > Preferences**.
2. Expand **Composer > Configuration Server**.
3. Check the box: **Create router predefined statistics** when connecting to Configuration Server.

Orchestration

In addition to specifying the HTTP request parameters, both **Universal Routing Server (URS)** and **Orchestration Server (ORS)** must be properly configured outside of Composer using **Configuration Manager** or **Genesys Administrator**. In addition to specifying HTTP request parameters, the URS configuration option strategy must be set to ORS. This ensures that URS is prepared to process interactions according to requests received from ORS. Important! if you have both Composer and IRD set up in the same environment, check in **Interaction Routing Designer's Loading View** that you have not loaded an IRD 7.x routing strategy on the same Route Point DN where the built-in strategy is loaded. This will create a conflict and cause your SCXML application not to launch.

Stream_Manager

Perform these steps in Configuration Manager or Genesys Administrator if using Stream Manager to play treatments via the Composer treatment blocks (such as PlaySound). After installing Stream Manager as described in the **Framework 7.6 Stream Manager Deployment Guide**:

1. Set up a SIP <Switching Office and a SIP Switch.
2. Set up a SIP T-Server with an association to the SIP Switch.
3. For your SIP T-Server, ensure that the sip-port option under the **TServer** section is unique in your environment.
4. Make sure there is a connection between your SIP T-Server and Stream Manager.
5. For Stream Manager options, in the **contact** section, make sure the SIP port is unique in your environment.
6. On your SIP Switch, create a DN of type Voice over IP Service to enable Stream Manager to properly play the treatments. For information on Stream Manager and the Voice over IP Server type DN, refer to

the *Voice Platform Solution 8.1 Integration Guide*.

7. In the Annex tab of this DN, add a section called TServer with the following options:
 - Name: contact, Value: :<IP Address of Stream Manager>:<SIP Port of Stream Manager>
 - Name: service-type, Value: treatment

Optional

8. You may also need a DN of type Trunk for your SIP softphone. In the Annex tab, add a section called TServer.
 - Name: contact, Value:<IP address of where SIP softphone is running>

Defining Preferences

You can configure **Preferences** for SCXML-based routing applications now or later.

ORS_Debugger

You can configure Preferences for the **ORS Debugger** now or later. To set ORS Debugger preferences:

1. Select **Window > Preferences**, then expand **Composer** and select **Debugging**.
2. Specify the following settings:
 - **Network Interface.** Composer debugging uses this setting to make the socket connection for the Debugger control channel. Select the interface that is applicable to your scenario. The debugging server (GVP or ORS) must be able to access the Tomcat server, bundled as part of Composer, for fetching the Voice or Routing application pages. If you have multiple NIC cards of multiple networks (such as Wireless and LAN) select the interface on which GVP or ORS will communicate to your desktop. In case you are connected over VPN, select the VPN interface (such as PPP if connected via a Windows VPN connection).
 - Enter the **Name, Display Name, and IP Addresses.**
 - **Client Port Range.** Enter a port range to be used for connection to ORS for SCXML debugging sessions.
3. Expand **Debugging**, select **ORS Debugger**, and specify the fields below. You can change this information when creating a **launch configuration**.
 - **ORS Server Host Name.** Enter the IP address for the ORS Server.
 - **ORS Server Port.** Enter the debugger port for the ORS Server. This is defined in the ORS configuration as [scxml]:debug-port, and defaults to 7999. ORS must have debug-enabled set to true.

Note: New **launch configurations** are pre-populated with the above host name and port information, which can be changed.

- **Use Secure Connections.** Check to enable secure communications (SSL/TLS) between the Composer client and ORS, for SCXML debugging sessions. The connection between Composer and ORS is mutually-authenticated TLS if implemented on the ORS side. Note: As of the Composer 8.1.1 release date, this feature is not yet implemented on the ORS side.

Upgrading Workflows

Upgrading Projects and Diagrams

See topic [Upgrading Projects and Diagrams](#).

Upgrading Workflows Prior to 8.0.4

Some previously created workflow diagrams cannot be upgraded:

- Composer 8.0.2 began support for the creation and testing of SCXML-based workflows for inbound voice use cases. Upgrading workflow diagrams created in the 8.0.2 release of Composer, which introduced this new feature, is therefore not supported.
- Composer 8.0.3 began support for the Context Services option of the Universal Contact Server Database and the processing of multimedia interactions. This release also introduced interaction process diagrams, which are roughly the equivalent of IRD business processes. Upgrading workflow diagrams created in the 8.0.3 release of Composer, which introduced these new features, is therefore not supported.

Migrating IRD Strategies into Composer Projects

Starting with Composer 8.1, you can migrate routing strategies created with Interaction Routing Designer 8.0+ into Composer Projects as SCXML-based workflow diagrams. For more information, see the [IRD to Composer Migration Guide](#).

Preferences for Routing Applications

Composer preferences apply to all Projects within the workspace. To open the Preferences dialog box, select **Window > Preferences**. You can set preferences for the following:

- [Business Rules](#)
- [Composer Diagram](#)
- [Configuration Server](#)
- [Context Services](#)
- [Customizer](#)
- [ORS Debugger](#)
- [GAX Server](#)
- [Help](#)
- [ISS .NET Preferences](#)
- [Orchestration Server Options](#)
- [Orchestration Server Preferences](#)
- [Time Zone](#)
- [Tomcat](#)
- [SCXML File](#)
- [Security](#)
- [XML Preferences](#)

Tip

You can also set options in the Project Properties dialog box. Right-click a Project and select **Properties**

Business Rule Preferences

See Business Rule Preferences in [Business Rule Common block](#).

Configuration Server Preferences

To set preferences for [connecting to Configuration Server](#):

1. Select **Window > Preferences > Composer > Configuration Server**.
2. Select or clear the check box for **Connect to the Configuration Server on startup**.
3. Select or clear the check box for **Create Router predefined statistics when connecting to Configuration Server**. Set this preferences if you plan to [route based on the value of a URS predefined statistic](#). For more information on URS predefined statistics, see the chapter on routing statistics in the [Universal Routing 8.1 Reference Manual](#).
3. Select or clear the check box for **Validate Skill Expressions**. You have the option of clearing the check box when using complex skill expressions that use both literal expressions and variables, for which skill expression validation fails.
4. Specify Configuration Database object validation:
 - **No validation**. You may wish to select this option if objects that will used in routing have not yet been configured. You may also wish to select this option if you do not have the required Configuration Database permission as described in the [Genesys Security Deployment Guide](#). For the Configuration Database, permissions and security are defined in the Security tab of the properties dialog box in Configuration Manager or (for web access) [Genesys Administrator](#). The No Validation setting also allows application development to continue when access to Configuration Server is not currently available. Composer can still validate strategies with the Configuration Server items excluded.
 - **Validate if connected**. If you will not always be connected to Configuration Server, you may wish to select this option.
 - **Validate**. Select to have Composer validate that the objects exist in the Configuration Database.
5. **Published interaction process diagram when it is saved**. If checked, Composer will [publish](#) an interaction process diagram when it is saved. It will not publish or prompt to connect to Configuration Server if disconnected. Note: This auto-publish does not display a message when publishing is successful. However, it will display message if publishing fails.
6. Check or uncheck **Prompt to save before Publishing Interaction Process Diagram**.
7. uncheck **Delete published objects when Interaction Process Diagram is deleted**.
8. uncheck **Delete published objects when Project is closed or deleted**.
9. Set the **Inactivity Timeout** preference to have Composer automatically close the Configuration Server connection when the user does not interact with Composer in any way for the inactivity-timeout period as described in the Inactivity Timeout chapter of the Genesys Security Deployment Guide. Composer displays a warning dialog two minutes in advance of this time. By default, the inactivity timeout is to be set to 0 (turned off).
10. Keep the **Fetch Timeout (sec)** value to use the Composer default of 10 seconds. If configured, the Fetch Timeout value will be used as the timeout for fetching to Configuration Server queries. While fetching larger amounts of data, set the Fetch Timeout value accordingly. Note: Any change in the Fetch Timeout value requires a re-connection to Configuration Server.

Diagram Preferences

Select **Window > Preferences > Composer > Composer Diagram**. The following preferences for diagrams can be set in the Preferences dialog box:

Global Settings

1. Select or clear the check box for each of the following diagram global settings:

- **Show Connection Ports.** If enabled, connection ports (both exception ports and out ports) are always displayed on blocks. This makes it convenient to draw links between blocks and to get immediate feedback on how many ports each block provides. However, in this case, the ability to reposition connections on a block is not available. If switched off, connection ports are not displayed by default, but repositioning or finer control over connection link placement becomes available. Note: This preference applies to all projects and is not available for individual projects.)
- **Show popup bars.** If enabled, this setting displays basic blocks from the blocks palette in a pop-up bar if you hover your mouse on the diagram for one or two seconds without clicking. Note: blocks are shown in icon view only.)
- **Enable animated layout.** If enabled, causes diagrams to gradually animate to their location when the Diagram \> Arrange \> Arrange All menu option is clicked.
- **Enable animated zoom.** If enabled, while using the zoom tools, shows a gradual transition between the initial and final state of the diagram on the canvas. If off, the zoom is instantaneous. Similar behavior for animated layout when the Diagram \>\> Arrange \>\> Arrange All menu option is clicked.
- **Enable anti-aliasing.** If enabled, improves the appearance of curved shapes in the diagram. You can see its effect on the circles in the Entry and Exit blocks.
- **Show CodeGen success message.** If unchecked, then the confirmation dialog at the completion of code generation will not be shown.)
- **Prompt to Save Before Generating Code.** If checked, when you generate code for an unsaved diagram, a prompt appears indicating the diagram has been modified and asking if you want to save the changes before generating code. The dialog box also contains a checkbox: Automatically save when generating code and do not show this message again.
- **Show Validation success message.** If unchecked, then the confirmation dialog at the time of Validation will not be shown.)
- **Enable Validation for Prompt Resources.** This preference is used for voice applications. If unchecked, then a validation check for missing prompts is not performed at the time of Validation.
- **Interaction Process Diagram.** If unchecked, Composer will save Interaction Process Diagrams before publishing.
- **Prompt to delete Published objects when Interaction Process Diagram is deleted.** If unchecked, Composer will attempt to delete any Published objects when an Interaction Process Diagram is deleted. If Composer is not connected to Configuration Server, object

deletion will not work.

- **Parameters auto synchronization** (available starting with 8.1.410.14). This option reduces developer coding time by enabling Composer to automatically declare variables in a Main diagram to match input/output variable names in Subdialog block/Subroutine diagrams and to automatically perform the mapping. This feature is available for both user and system variables. For example, if a Subroutine diagram returns a variable called “xyz” and if Composer automatically declares “xyz” in the Main diagram to hold the output, then you do not have to manually do the mapping. If enabled, you are prompted for auto-synchronization whenever there is a need to change parameters names or add new variables in the dialogs.

Scenarios:

1. Subdialog or Subroutine Diagram: Entry Block—The auto-synchronization process will synchronize any newly added/updated variables and existing variables in the Subdiagram. If you add a new Input type variable, a prompt appears asking whether to add a corresponding Input parameter. You are also prompted to select or add the Input source variable in all the called Subroutine diagrams. New parameter naming in the calling Subdialog block is the same as the Input variable added in the Entry Block. If the Subroutine diagram is called from many diagrams, Composer provides a variable selection option for the called diagrams.
2. Main callflow Diagram: Entry Block—If you add a new Input type variable, a prompt appears asking whether to add the corresponding input parameter. You are also prompted to select or add an Input source variable in all the called Play Application blocks. New Parameter naming in the calling Play Application block is the same as the Input variable added in the Entry Block. If the Main diagram was called from multiple Play Application blocks, a variable selection option for all the called blocks is provided.
3. Subdialog or Subroutine diagram: Exit Block—If you change or delete a return parameter, a prompt appears on whether to delete the Output parameter and/or the missing ones in case of a change in all the called Subroutine or Subcallflow diagrams.
4. The auto-synchronization parameter option also applies when there is a change in a configured Subroutine diagram. The auto-synchronization dialog confirmation appears as soon as a Subroutine diagram is added/updated. If the confirmation dialog is selected, it automatically synchronizes the Subroutine parameters to the Main diagram. This auto-synchronization prompt always appear even though the same diagram is updated again. When Output parameters are added in the Exit block, parameter synchronization also occurs.
5. **Application URL for Publish and Debugging.** Select **Use IP Address** or **Use Host Name**.

Notes:

Composer creates unique names for auto-sync variables, such as <SubBlockName>_<VariableName>. SubBlockName is the name of the Subroutine/ Subdialog / Play Application blocks where the Subroutine diagram is being invoked. VariableName is the input variable name created in a Subroutine diagram.

2. Click **Apply**.

Colors and Fonts

1. Select **Appearance** under Composer Diagram.

2. Click **Change** and make selections to change the default font if you wish.
3. Click the appropriate color icon beside any of the following and make selections to change color:

- **Font color**
- **Fill color**
- **Line color**
- **Note fill color**
- **Note line color**

4. Click **Apply**.

Connections

1. Select Connections under Composer Diagram.
2. Select a line style from the drop-down list:

- **Oblique**
- **Rectilinear**

3. Click **Apply**.

Pathmaps

1. Select **Pathmaps** under Composer Diagram.
2. Click **New** to add a path variable to use in modeling artifacts, or If the list is populated, select the check box of a path variable in the list.
3. Click **Apply**.

Printing

1. Select **Printing** under Composer Diagram.
2. Select **Portrait** or **Landscape** orientation.
3. Select units of Inches or Millimetres.
4. Select a paper size (default is Letter).
5. Select a width and height (for inches, defaults are 8.5 and 11; formillimeters, defaults are 215.9 and 279.4).
6. Select top, left, bottom, and right margin settings (for inches, defaults are 0.5; for millimeters, defaults

are 12.7).

7. Click **Apply**

Rulers and Grid

You can make use of rulers and grids when creating diagrams. Rulers and grids can provide a backdrop to assist you in aligning and organizing the elements of your callflow diagrams.

1. Select Rulers and Grid under Studio Diagram.
2. Select or clear the **Show rulers for new diagram** check box (not selected by default).
3. Select ruler units from the drop-down list:
 - **Inches**
 - **Centimeters**
 - **Pixels**
4. Select or clear the Show grid for new diagrams check box (not selected by default).
5. Select or clear the Snap to grid for new diagrams check box (selected by default).
6. Type a value for grid spacing (for inches, the default is 0.125; for centimeters, the default is 0.318; for pixels, the default is 12.019).
7. Click **Apply**.

Setting Context Services Preferences

Go to **Window > Preferences > Composer > Context Services** to open the Context Services dialog box. If using a Composer version prior to 8.1.440.18, the dialog box will not contain a **Service management** section.

Context Services ↶ ↷ ↸

Context Services are provided by the Universal Contact Server (UCS) and the Genesys Mobile Services (GMS).

Customer Profile management. These settings apply to Profile related blocks.

Connect to the Universal Contact Server when designing diagrams

Server Hostname

Server Port

Base URL

Security Settings

Use secure connection:

Never TLS

Use authentication

User

Password

Service management. These settings apply to Service related blocks.

Use Genesys Mobile Services

Connect to the Universal Contact Server when designing diagrams

Server Hostname

Server Port

Base URL

Tenant

Security Settings

Use secure connection:

Never TLS

Use authentication

User

Password

Context Services objects Validation

No validation

Validate if connected

Validate

Locale settings

Time Zone

Guidelines for Context Services Preferences

[+] Guidelines for Context Services Preferences

The table below supplies some guidelines for defining Context Services Preferences.

Installation Type	Customer Profile Management	Service Management
Context Services 8.1 or earlier - Profile and Service APIs served by UCS	Set UCS parameters according to UCS options.	Do not check the Use Genesys Mobile Service checkbox. Set the UCS parameters according to UCS options.
Context Services 8.5 or later - No Load Balancer	Set UCS parameters according to UCS options.	Check the Use Genesys Mobile Service checkbox. Set GMS parameters according to GMS options.
Context Services 8.5 or later - Load Balancer (LB)	Set UCS parameters to match the LB options.	Check the Use Genesys Mobile Service checkbox. Set GMS parameters to match the LB options.

Customer Profile Management Section

1. Use the [Guidelines for Context Services Preferences](#) section above for selecting/unselecting the **Connect to Universal Contact Server when designing diagrams** box.
2. Under **Server Host Name**, enter the server host IP address in your Configuration Database, which identifies the Universal Contact Server. See Tip below.
3. Enter the **Server Port number** for Universal Contact Server. For the port number, open the Universal Contact Server Application object in your Configuration Database, go to **Options** tab, select the **cview** section, and the port option.
4. Enter the **Base URL** for the Context Services server. This should only be configured if you use UCS 8.1. Do not set if you use UCS 8.5.
5. Under **Security Settings, Use secure connection**, select **Never** or **TLS** if Transport Layer Security is implemented as described in the [Genesys 8.1 Security Deployment Guide](#).
6. Select **Use Authentication** to require a user name and password when connecting to Universal Contact Server. If selected, enter the **User** and **Password** fields.
7. Click the **Test Connection** button (enabled if the **Connect to Universal Contact Server when designing diagrams** box is checked). Clicking should cause connection successful to appear. If not, check that Universal Contact Server is running and that the entered host/port values are correct. Other sources of error could be that the base URL parameter value is incorrect or the UCS version is not 8.1 or higher.
8. Under **Context Services object Validation**, select one of the following: **No validation**, **Validate if connected**, or **Validate**. This setting is used and shared by the [Profile/Service blocks](#).

Tip

Host/port/URL/tenant are used at design time by Composer (when the **Connect to Universal Contact Server when designing diagrams** box is selected). They are also used by Composer when publishing an **interaction process diagram**. Composer stores these parameters in the EnhancedRoutingScript objects. SCXML applications can then read those settings at runtime to connect to UCS/GMS accordingly.

Service Management Section

1. Select either **Use Genesys Mobile Services** or **Connect to the Universal Contact Server when designing diagrams**. See [Guidelines for Context Services Preferences](#) section above for more information. Steps 2, 3, and 4 below relate to UCS or GMS, depending on the **Use Genesys Mobile Services** box.
2. Under **Server Host Name**, enter the host IP address. See above note (Tip).
3. Enter the server port number.
4. Enter the **Base URL** for the host. When using GMS, the base URL is normally /genesys/1/cs.
5. Enter the **Tenant**. GMS Context Services (optionally) supports multi-tenancy. The tenant to use is passed as a header (ContactCenterId=x) of the request. This field is disabled when **Connect to the Universal Contact Server when designing diagrams** is selected.
6. Under **Security Settings, Use secure connection**, select **Never** or **TLS if Transport Layer Security** is implemented as described in the [Genesys 8.1 Security Deployment Guide](#).
7. Select **Use authentication** to require a user name and password. If selected, enter the User and Password fields.
8. Click the **Test Connection** button. Clicking should cause connection successful to appear. When using GMS, no connection is made from Composer to GMS. Connections to GMS are initiated only at runtime by ORS/MCP.
9. Under **Context Services object Validation**, select one of the following: **No validation**, **Validate if connected**, or **Validate**. This setting and the setting below is used and shared by the [Profile/Service blocks](#).
10. Under **Local Settings**, select the time zone.

Tip

Composer can successfully communicate with UCS at design stage whatever the UCS mode is (production or maintenance). However, UCS needs to be in production mode at runtime stage (when running Context Services SCXML or VXML applications, even when using GVP Debugger).

Customizer Preferences

To bring up Customizer Preferences:

1. Click the **Window** menu.
2. Select **Preferences**.
3. Expand **Composer**.
4. Select **Customizer Preferences**. The Customizer Preferences dialog box opens. The Callflow Diagram Editor and Workflow Diagram Editor customization plug-ins are display only and can be used for debugging.

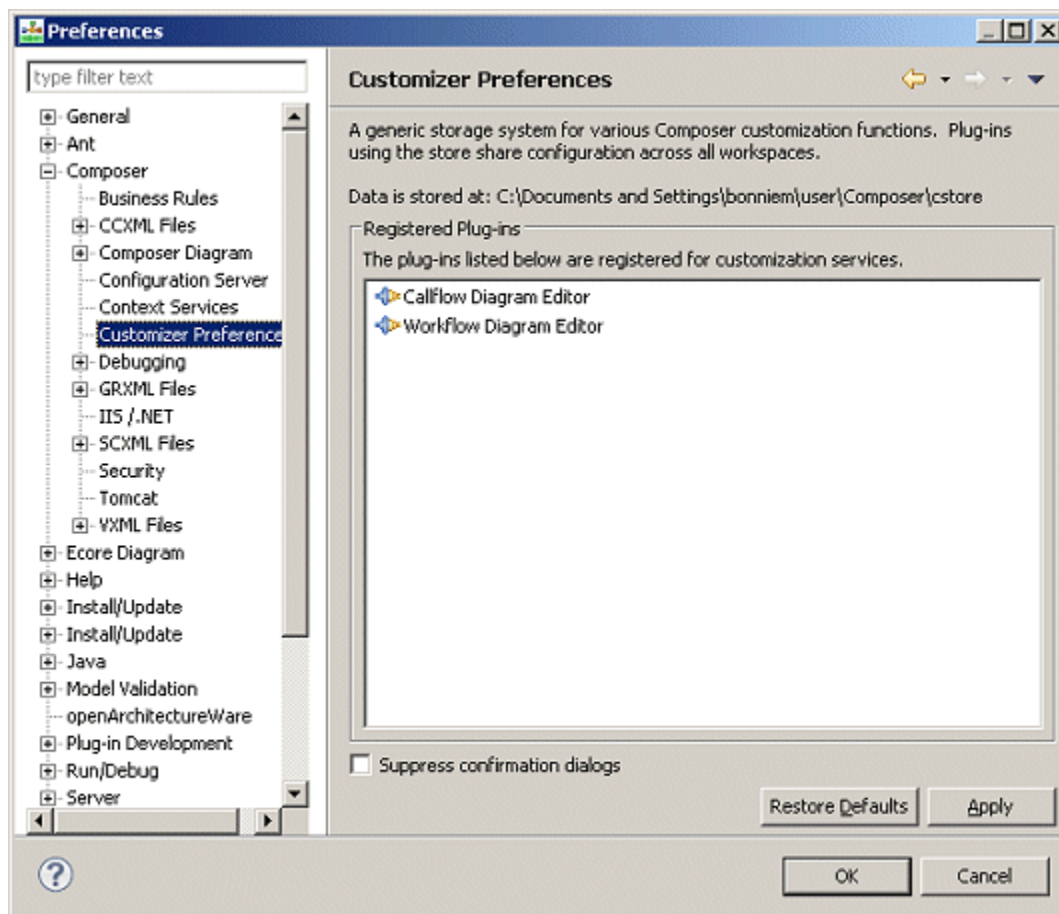

The Customizer

Preferences dialog box:

- Reports on the location of the storage area (cstore directory) on disk. Diagrams that you save as templates are stored here.
- Lists registered plug-ins as shown in the Customization Manager view.
- Allows you to suppress confirmation dialogs associated with plug-ins. If checked, it suppresses the

success/failure indicator message when you save a diagram as a template.

ORS Debugger Preferences

Select **Window > Preferences > Composer > Debugging > ORS Debugger**. **ORS Debugger preferences** are usually set during **post-Installation configuration**, when you first run Composer. A Debugger Cheat Sheet (**Help > Cheat Sheets > Composer > Routing Applications**) also provides detailed configuration instructions.

GAX Server Preferences

Select **Window > Preferences > Composer > GAX Server**.

If using the **OPM Block** for a voice or routing application, you must set GAX Server Preferences.

Tip

GAX refers to a **Genesys Administrator** Extension (GAX) plug-in application used by **Genesys EZPulse**, which is accessible from a web browser. EZPulse enables at-a-glance views of contact center real-time statistics in the GAX user interface. Composer diagrams connect to GAX using the preference login credentials for fetching the Audio Resource Management (ARM) parameters or IDs list configured for the tenant as described in the Configuration options appendix of the *Genesys Administrator Extension Deployment Guide*.

The following preferences can be set in the GAX Server Preferences dialog box:

- **Server Host Name/IP.** Enter the hostname or address of the Application server hosting the GAX Server.
- **Port Number.** Enter the port number for the GAX Server used in your environment.
- **Username.** Enter the username defined in the Configuration Database for logging into the GAX server.
- **Password.** Enter the password defined in the Configuration Database for logging into the GAX server.

Help Preferences

Window > Preferences > Composer > Help

The resulting page contains a link to the online Composer help wiki. For example:

<http://docs.genesys.com/?title=Special:ComposerHelp&keyword={keyword}&locale={locale}&version={version}>

IIS.NET Preferences

Select **Window > Preferences > Composer > IIS/.NET**.

IIS/.NET preferences are usually set during post-installation configuration, when you first run Composer. Detailed post-installation configuration instructions are provided in the Setting IIS Preferences Cheat Sheet (**Help > Cheat Sheets > Composer > Building Voice Applications**), and also in [Post-Installation Configuration](#).

Orchestration Preferences

Select **Window > Preferences > Composer > Orchestration Server**. Enter the **Orchestration Server Load Balancer** URL.

Also see:

- [Orchestration Options](#)
- [Orchestration Extensions](#)

Orchestration Options

Using Composer, you can create **Routing applications** for the Genesys **Orchestration Platform 8.x** (ORS)—which takes the Genesys core capability of routing, extends it, and integrates it tightly with other Genesys products.

There are two ways to view **Orchestration Server** options:

1. Right-click a Project and selecting Properties.
2. When a Project is selected, click the Properties menu and select Properties.

In the resulting dialog, select Orchestration Options. The options are:

- **Use External Events**
- **Start Workflow SCXML application on interaction.onrouterrequest event** (described below)
- **Use Single GVP Session to Execute Treatments**
- **Use Interaction Submitters**
- **Interaction Detach**

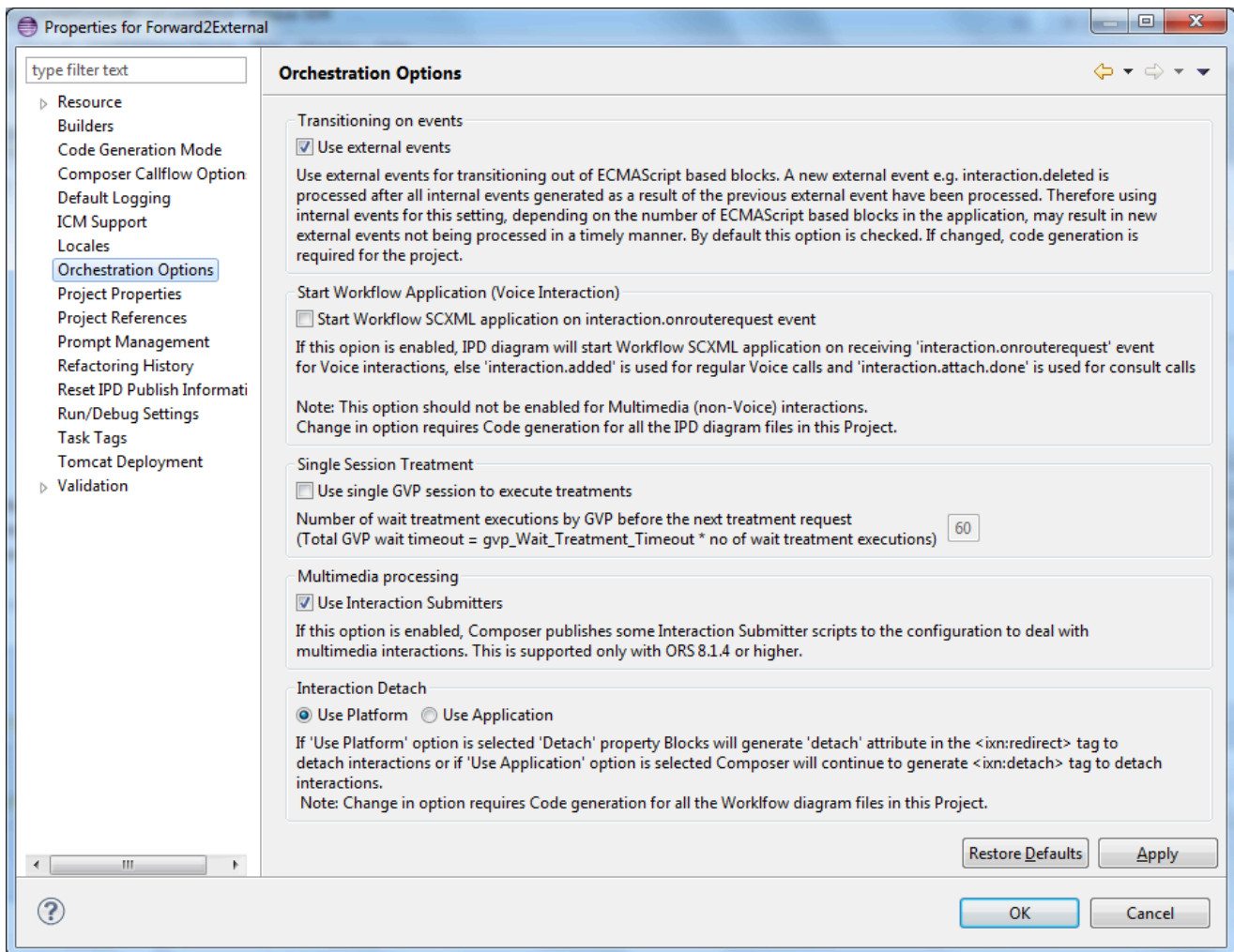

Also see:

- [Orchestration Preferences](#)
- [Orchestration Extensions](#)

Start Workflow SCXML application on interaction.onrouterequest Event

Starting with 8.1.400.37, Composer adds a Project-level option, **Start Workflow SCXML application on interaction.onrouterequest event**, that you can use to control the start of a workflow SCXML application. If enabled, an interaction process diagram will start the workflow diagram SCXML upon receiving the `interaction.onrouterequest` event for voice interactions. If this option is not enabled, Composer will use the `interaction.added` event for regular voice calls and

the `interaction.attach.done` event for consult calls. To change this option, you must generate code for all the interaction process diagram files in a Project. By default, this option is not enabled. As result, older applications will continue to start the workflow diagram SCXML upon receiving the `interaction.added` event. This option should not be enabled for multimedia (non-voice) interactions. Composer also adds the `interaction.onrouterequest` event to the default set of voice event handlers.

Orchestration Extensions

Starting with 8.1.4, Composer blocks used to build routing applications (with the exception of the Disconnect and EndParallel blocks) add a new ORS Extensions property. Use this property to add custom attributes into any/all states and sub-states for any block they are configured in. Add the ORS Extensions property to the Properties view for a selected block by clicking the **Show Advanced Properties** button.

Show Advanced Properties

When creating a new diagram in Composer perspective, this button appears on the right side of the Composer GUI, between the palette of blocks and the Properties view.



This property gives the ability to use any attribute **Orchestration Server** supports in addition to the SCXML standard. For information on these attributes, see the attributes prefixed with "_" in the **SCXML Elements** section of the *Orchestration Server Developer's Guide*. For example, you can specify additional attributes to be added into the SCXML <state> element, which Orchestration Server can then use to control **persistence** on a <state> level and for other functionality in the future.

Orchestration Options

Selecting Properties from the Project menu opens a dialog box showing the properties of the selected Project or of the Project that contains the selected resource. Select **Orchestration Options** to view other settings.

Detaching Interactions

Starting with Release 8.1.400.35, Composer adds a new Project properties option, **Interaction Detach**, in the Orchestration Options dialog (shown below), which can generate the detach attribute in the `ixn:redirect` tag in the following Routing blocks: (**Default Route**, **Force Route**, **Queue Interaction**, **Route Interaction**, **Routing Rule**, and **Target**).

Selecting **Use Platform** in the dialog sets the attribute value to `true` and instructs Orchestration Server to detach an interaction from the current session before routing to the specified target, which can free Orchestration Server to start processing the next session. Keeping the default of **Use Application** causes the detach attribute not to be used, in which case the `<ixn:detach>` tag will be used by the generated SCXML application.

Notes:

- Previously created Projects upgraded to this version will have the **Use Application** detach option and generate the `<ixn:detach>` tag for the detach operation. Also, the default value of the Detach property for the above Routing blocks is changed to `true`.
- Any new Routing blocks added will have the Detach Property default set to `true`.
- Diagrams upgraded to this version will continue to have the previously set values for the Detach property.

You can specify the detach method at the Composer level, at the Project level, or at the Block level.

Composer Level

Use the **Detach** and **Attach** blocks available from the Flow Control palette group.

Project Level

Right-click a Project, select **Properties > Orchestration Options**. The dialog box below opens.

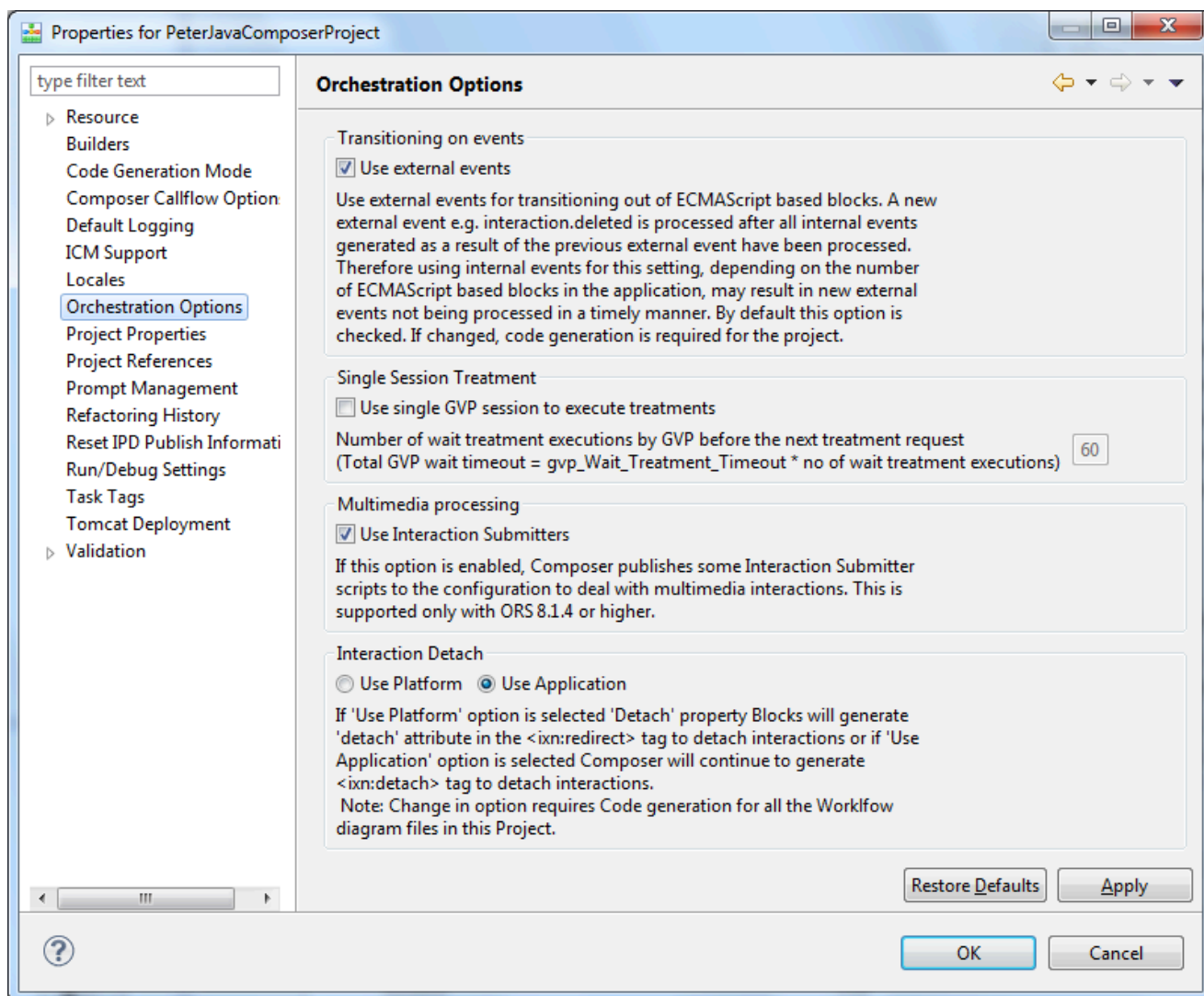

Under **Interaction Detach**, the options are **Use Platform** or **Use Application**.

[+] Use Platform

Interaction Detach = Use Platform (default value for new Projects)

If **Use Platform** is selected, Composer will generate the new detach attribute in the `<ixn:redirect>` tag in the above Routing blocks that have the Detach property enabled.

```
<state id="_reserved_Target1_redirect">
  <onentry>
    <ixn:redirect detach="true" requestid="App_Target1['requestid']"
interactionid="system.InteractionID" from="system.ThisDN"
    to="App_Target1['targetResource']" type="_genesys.queue.rType.RouteTypeDefault"
hints="_data.All_Locations"/>
  </onentry>
  <transition event="interaction.redirect.done">
```

```
cond="_event.data.requestid==App_Target1['requestid']" target=
  "$$_MY_PREFIX_$_reserved_NextBlock"/>
</state>
```

eServices Blocks and Use Platform

Use Platform in SCXML code generation is applicable only for blocks that use the `<ixn:redirect>` tag. The following eServices blocks do not use `<ixn:redirect>` tag and therefore cannot use the Use Platform option shown above: Chat Transcript, Create Email, Email Forward, Email Response, and Create SMS. You can still change the default value for the Detach property in these blocks.

Event Handling

When enabling the **Use Platform** option, Composer-generated code for the Routing blocks with the Detach property enabled will no longer handle detaching (`<ixn:detach>`) the interaction and re-attaching (`<ixn:attach>`) the interaction after a failed `<ixn:redirect>`.

The following events will no longer be handled by the generated code for these blocks: `interaction.detach.done` and `interaction.attach.done`.

Starting with 8144, Composer validates `error.interaction.attach` and `error.interaction.detach` exceptions in the Detachable blocks. If **Platform Detach** is enabled, the Detachable blocks having the above said exceptions will throw a warning.

The `interaction.deleted` event will be discarded at the application level (interaction process dialog Events) when its `resultof` attribute value is `detaching` in order to prevent premature application termination. As a result, application developers are no longer be required to handle the `interaction.deleted` event in multiple places when detaching interactions.

[+] Use Application

Interaction Detach = Use Application (default value for upgraded Projects)

If **Use Application** is selected, Composer will continue to generate the `<ixn:detach>` tag to detach interactions, in addition to the `<ixn:redirect>` tag.

```
<state id="_reserved_Target1_detach_run">
  <onentry>
    <ixn:detach interactionid="system.InteractionID"
requestid="App_Target1['requestid']"/>
  </onentry>
  <transition event="interaction.detach.done"
cond="_event.data.requestid==App_Target1['requestid']"
target="$$_MY_PREFIX_$_reserved_Target1_redirect"/>
</state>
<state id="_reserved_Target1_redirect">
  <onentry>
    <!-- NO detach attribute attribute usage. This code must run on ORS without in-
redirect detach support -->
    <ixn:redirect requestid="App_Target1['requestid']"
interactionid="system.InteractionID" from="system.ThisDN" to="App_Target1['targetResource']"
type="_genesys.queue.rType.RouteTypeDefault" hints="_data.All_Locations"/>
  </onentry>
```

```

    <transition event="interaction.redirect.done"
cond="_event.data.requestid==App_Target1['requestid'])"
target="$$_MY_PREFIX_$$._reserved_NextBlock"/>
    <transition event="error.interaction.detach"
cond="_event.data.requestid==App_Target1['requestid'])"
target="$$_MY_PREFIX_$$._reserved_Target1_attach">
        <script>
            App_Target1['error.rethrow'] =
{'name':_event.name,params: {'requestid':_event.data.requestid,'error':_event.data.error,'description':_event.da
        </script>
    </transition>
</state>
<state id="_reserved_Target1_attach">
    <onentry>
        <ixn:attach interactionid="system.InteractionID"
requestid="App_Target1['requestid']"/>
    </onentry>
    <transition event="interaction.attach.done"
cond="_event.data.requestid==App_Target1['requestid'])"
target="$$_MY_PREFIX_$$._reserved_NextBlock">
        <!-- re-throw original error.interaction.redirect for the application -->
        <script>
            __Raise('error.interaction.redirect', App_Target1['error.rethrow'].params);
        </script>
    </transition>
</state>

```

Block Level

If the `Detach` property is set to `true` for the above Routing blocks, Orchestration Server uses the new detach attribute and the interaction is detached from the session before routing to the specified target.

If the `Detach` property value is set to `false` (default), then no detach occurs before routing.

If the `Target` block `Route` property = `true`, then code generation will detach the interaction before `queue:submit` since the Orchestration Platform will redirect after `queue:submit`. This is applicable for both **Use Platform** and **Use Application** under **Interaction Detach**.

Inter-Session Communication

Composer-generated applications support passing context from the source application session to the destination application session when the interaction is associated with a new Orchestration session after a detaching operation in the originating Orchestration session. This allows the new application that runs in the new session to access data (variables) previously collected in the originating session.

This feature is controlled by properties `Pass Context`, `Pass Context Timeout` of detachable blocks in the originating Orchestration session, and by properties `Read Context`, `Read Context Timeout` of the destination interaction process diagram (IPD).

To support this feature, the Composer originating application writes some data to the interaction user data just before detaching the interaction. When enabling the **Use Platform** option, this user data

update must be done right before the `<ixn:redirect>`.

SCXML File Preferences

To set SCXML file preferences:

1. Select **Window > Preferences > Composer > SCXML Files**.
2. Select the suffix that Composer should add to SCXML files. The default is scxml.
3. Select the encoding for the file. The encoding attribute in an SCXML document specifies the encoding scheme. The encoding scheme is the standard character set of a language. The SCXML processor uses this encoding information to know how to work with the data contained in the SCXML document. UTF-8 is the standard character set used to create pages written in English. Select from the following:
 - ISO 10646/Unicode(UTF-16LE) Little Endian
 - US ASCII
 - ISO Latin-1
 - Central/East European (Slavic)
 - Southern European
 - Arabic, Logical
 - Arabic
 - Chinese, National Standard
 - Traditional Chinese, Big5
 - Cyrillic, ISO-8859-4
 - Cyrillic, ISO-8859-5
 - Greek
 - Hebrew, Visual
 - Hebrew
 - Japanese, EUC-JP
 - Japanese, ISO 2022
 - Japanese, Shift-JIS
 - Japanese, Windows-31J
 - Korean, EUC-KR
 - Korean, ISO 2022
 - Thai, TISI
 - Turkish
4. Check the box to warn if no grammar is specified when validating SCXML files (not selected by default).
5. Click **SCXML Templates**.

SCXML Templates

Composer provides a set of predefined templates when writing SCXML code to create routing strategies. You can either start off from scratch in the SCXML editor or use one of the available templates as a starting point. Use this preference to create, edit, or remove templates as well as to import and export templates.

1. Select **Window > Preferences > Composer > SCXML Templates**.
2. In the resulting Templates dialog box, do one of the following:
 - To create a new template click **New...** The New Template dialog box opens for naming and describing the new template.
 - To edit an existing template, select its row and then click **Edit...** The Edit Template dialog box opens for editing.
 - To remove a template, select its row and click **Remove**. If you change your mind, click **Restore Removed**,
 - To import a template, click the **Import...** button, navigate to the folder containing the SCXML file, select the file, and click **Open**.
 - To export one or more templates, select the row(s) and click the **Export...** button. In the Export Templates window, click the target location and click **Save**.
 - If you change your mind after editing a predefined template, click **Restore Defaults**.
3. Click **Source**.

Source

Source preferences are based on the [XML Editor preferences](#). See that topic for more information.

Syntax Coloring

Syntax coloring preferences are based on the [XML Editor preferences](#). See that topic for more information.

Security Preferences

Use the Security preferences page to specify the location of the Trust Store that holds security certificates.

Window > Preferences > Composer > Security

The certificates are used, for example, when Composer **connects to Universal Contact Server** with a **secured connection**. By default, Composer uses the Java Runtime Environment (jre) Trust Store. The default password for the Trust Store is `changeit`.

Tomcat Preferences

Select **Window > Preferences > Composer > Tomcat** Tomcat preferences are usually set during post-installation configuration, when you first run Composer. Detailed post-installation configuration instructions are provided in the Configure Tomcat and Debugger Settings Cheat Sheet (**Help > Cheat Sheets > Composer > Building Voice Applications**), and also in [Callflow Post-Installation Configuration](#) or [Workflow Post Installation Configuration](#).

Introduction to Routing Workflows

This section gives a high-level overview of creating SCXML-based routing strategies ("workflows") in Composer's integrated development environment.

- [What is a Routing Workflow](#)
- [Architecture Diagram for Workflows](#)
- [Workflow Example and Palette](#)
- [SCXML File Editor](#)
- [Sessions and Interactions](#)
- [Interaction Process Diagrams](#)

What is a Routing Workflow?

What is Routing?

In the simplest terms, *routing* is the process of sending an interaction to a target, for example, sending an incoming telephone call to an agent. In practice, an interaction must undergo various types of processing between the time it arrives at the contact center and the selection and routing to the appropriate target. Each processing-point is an opportunity for some sort of processing to take place or for Universal Routing Server (URS) to make a decision based on the current situation—with the goal of getting the interaction delivered to the most appropriate target.

What is a Routing Workflow?

A **routing workflow** is a set of decisions and instructions that tells Universal Routing Server how to handle and where to direct interactions under different circumstances.

At any given processing-point in the workflow, only one of several possible outcomes can be optimal. Universal Routing Server uses the workflow instructions to determine which outcome is optimal and sends the interaction along a specified route accordingly.

There are various ways to create an SCXML-based workflow in Composer:

1. By working with blocks to **create a workflow** in **Composer or Composer Design perspective**.
2. By writing code in the **Composer_Code_Editors** (which may include using templates).
3. By **importing an existing workflow**.

Routing Blocks and Ports

Each processing-point is represented graphically in a workflow by a **routing block**, which has:

- One entry port
- One or more red exception ports
- One or more green exit ports.

The figure below shows how these ports appear for a block in Composer's workflow designer.

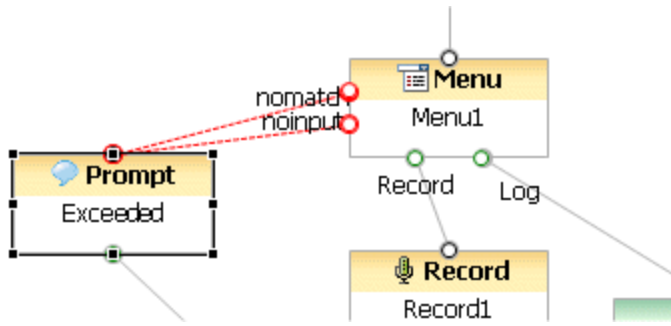

Architecture Diagram for Workflows

To give the "Big Picture" and show the various Genesys components used for SCXML-based workflows, below is a high-level diagram of the Universal Routing 8.x architecture.

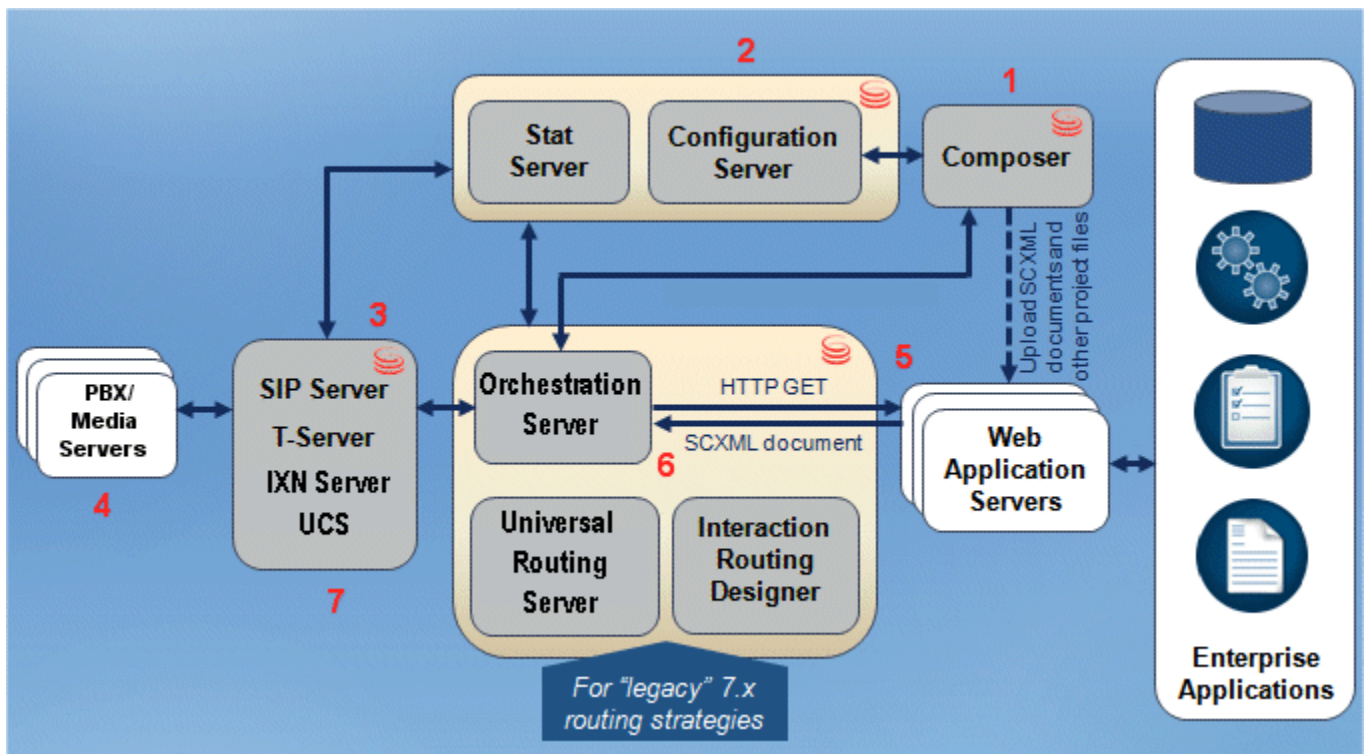

The SCXML-based strategy creation and processing steps above are keyed to the numbers below.

1. The developer specifies **Configuration Server** objects as routing **targets** prior to creating the routing application in **Composer**. For example, a routing target could be an agent (Person object) or Agent Group or an interaction can be sent to a queue. The developer may also create workflows that route based on the value of a **Stat Server statistic** or a statistic that you defined in **Composer's Statistics Builder**.
2. The developer (or other persona) creates and tests the routing application and manually deploys it on a **web application server**. Once this is done, the runtime life cycle of the routing logic can begin with a routing request.
3. URS gets an **EventRouteRequest** message from **T-Server** or another **media server** such as an **eServices media server**.
4. The request goes to the Routing Point. URS gets the URL of the application server to be contacted about SCXML strategy to be provided, which is a property of the Routing Point. After the URL is obtained, ORS issues the **HTTP GET** (or **POST**) request to the application server.
5. The application server executes the request and returns the SCXML document back to ORS.
6. Upon getting the response, ORS passes the received SCXML document to the SCXML engine. The SCXML

engine runs the SCXML application, invoking ORS/URS services as needed.

7. ORS or URS issues a RequestRouteCall message to the media server.

Delivering an Interaction to Agent Desktop

Once ORS/URS identifies a routing target, other servers are involved in the process of delivering the interaction to the agent desktop.

- In the case of voice interactions, SIP Servers /T-Servers are involved.
- In the case of PBX based architectures (not SIP servers), PBXes are involved (by the commands from T-Servers).

In summary:

Interaction Type	Target Identification	Deliver to Desktop
Multimedia	URS/ORS	Interaction Server > Media Server
Voice Over IP	URS/ORS	SIP Server (includes media control)
Old/PBX architectures	URS/ORS	T-Server > PBX

Workflow Example and Palette

The figure below shows an example routing workflow in Composer Design **perspective**.

The screenshot shows the Composer Design interface with a workflow diagram. The workflow consists of the following blocks and connections:

- Entry** block (black circle) connects to the **Assign** block.
- Assign** block (AssignDateTime) connects to the **Branching** block.
- Branching** block (Branching1) has three outgoing paths:
 - WeekEnd** path
 - default** path
 - An unlabeled path (likely for business hours)

A yellow callout box on the right provides the following details:

- Assign block:** Using assign block we are assigning variable CallerDay with `_genesys.session.dayInZone('ECT')` and CallerTime with `_genesys.session.timeInZone('ECT')`.
- Branching block:** In Branching block following conditions are checked:
 - If CallerDay is weekend then Weekend message will be played to the caller
 - If CallerDay is weekday and CallerTime is after business hours then After business hours message will be played to the caller
 - If CallerDay is weekdays and CallerTime is within business hours, then the call is load balanced between two agent groups

The Properties tab at the bottom shows the configuration for the selected **Assign** block:

Property	Value
Alias	
Name	AssignDateTime
Annotation	
Block Notes	
Assign	Assign Data
Assign Data	CallerDay=_genesys.session.dayInZone('EC...

As shown above, in Composer Design perspective, the palette of blocks appears on the left. When creating workflows, you drag blocks from palette, drop them in the center canvas area, configure their properties in the lower Properties tab, and connect them.

SCXML File Editor

Composer also has an editor for those who like to write their own code. The figure below shows example strategy code in Composer's [SCXML editor](#).

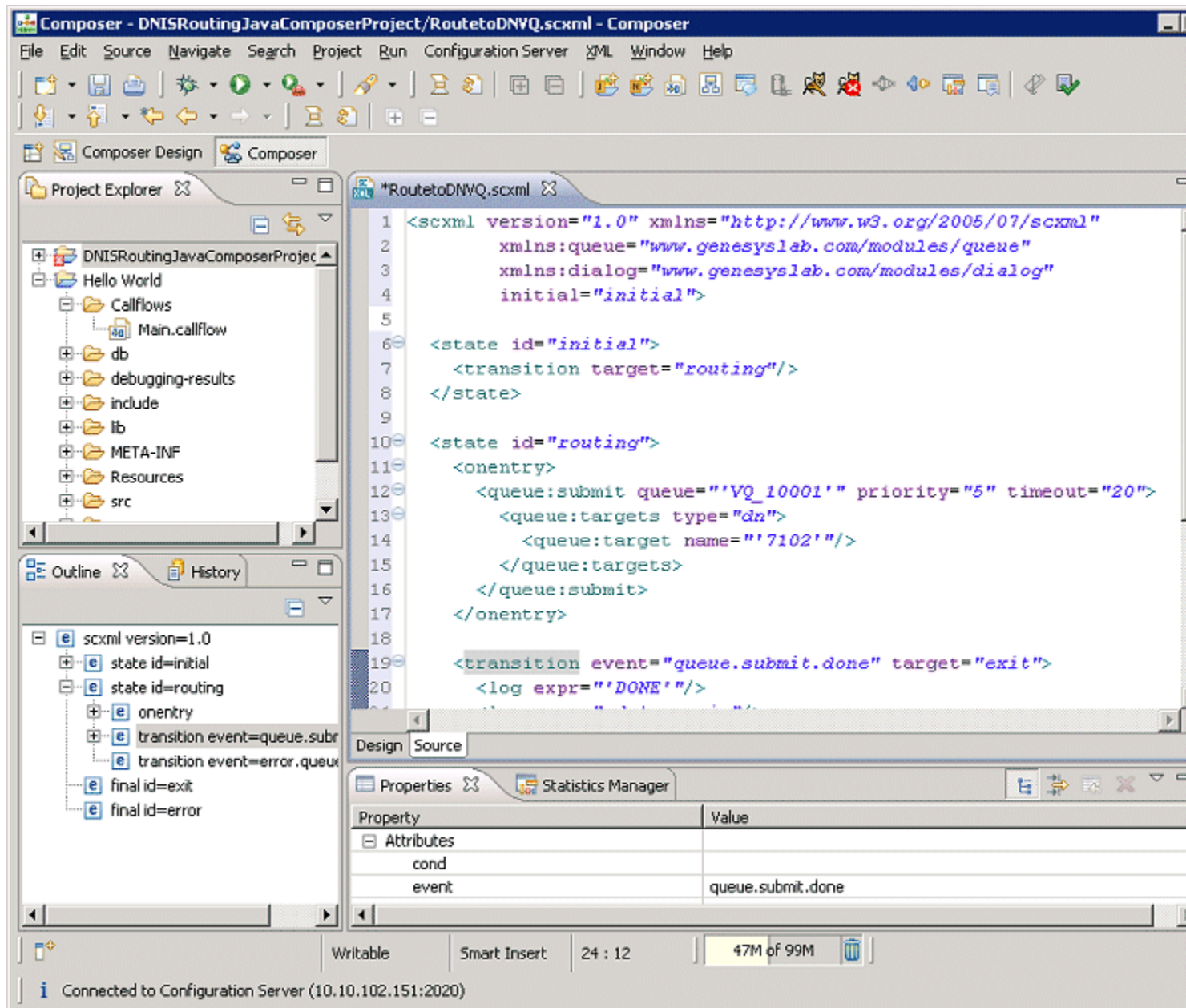

- [SCXML File Preferences](#) control colors and other aspects of SCXML editing.
- For editing functionality, see [Accessing the Editors and Templates](#).

- For sample strategies, see [Universal Routing 8.1 SCXML Strategy Samples](#).

Sessions and Interactions

Orchestration Server introduces the concept of sessions. An understanding of these concepts is important to effectively use Routing functionality in Composer. Please consult the *Orchestration Server 8.1 Deployment Guide* for references to detailed technical information.

Composer generated SCXML applications make sure that an SCXML session is created whenever an interaction is pulled from an Interaction Queue and presented to the SCXML application. This behavior applies to:

- All new interactions received by Orchestration platform.
- Interactions that have been placed in the interaction by an SCXML application.
- New interaction created by Orchestration platform as a result of an action (e.g., **E-mail Response** and **Create SMS** blocks).

However, under certain circumstances, use of the **SCXML State block** or a hand-coded subroutine may result in a new interaction being created. In such cases, special care must be taken to process the new interaction since the default behavior is to take action on the original interaction that resulted in the session being created. One of the following approaches is recommended in such cases.

- If the Interaction ID is not known, retrieve the Interaction ID from the `_genesys.ixn.interactions[x].g_uid` list.
- Place the new interaction in a different queue using the **Queue Interaction block**. When the interaction is presented to the workflow connected to the queue, a new session is created, thereby all further actions are performed on the presented interaction.

Interaction Process Diagrams

What is an IPD?

An interaction process diagram (IPD) provides a high level view of how multimedia interactions flow through various components like media servers, interaction queues, workbins, and workflows. An IPD is somewhat similar to a Business Process in [Interaction Routing Designer](#), but is [SCXML-based](#), contains additional functionality and works with [Orchestration Server](#).

Starting SCXML Page

In addition, an IPD functions as the starting SCML page for both voice and multimedia interactions and results in using the same session across the entire interaction process. It also updates objects in Configuration Server and activates the linkages specified in the IPD.

- When used for voice interactions or [interaction-less processing](#), an IPD contains a single [Workflow block](#).
- When used for multimedia interactions, an IPD contains at least one and possibly multiple [Media Server](#), [Interaction Queue](#), and [Workflow](#) blocks. The example shown below is available as a [template](#) (Routing After Sending Autoresponse) when you [create a new Project](#).

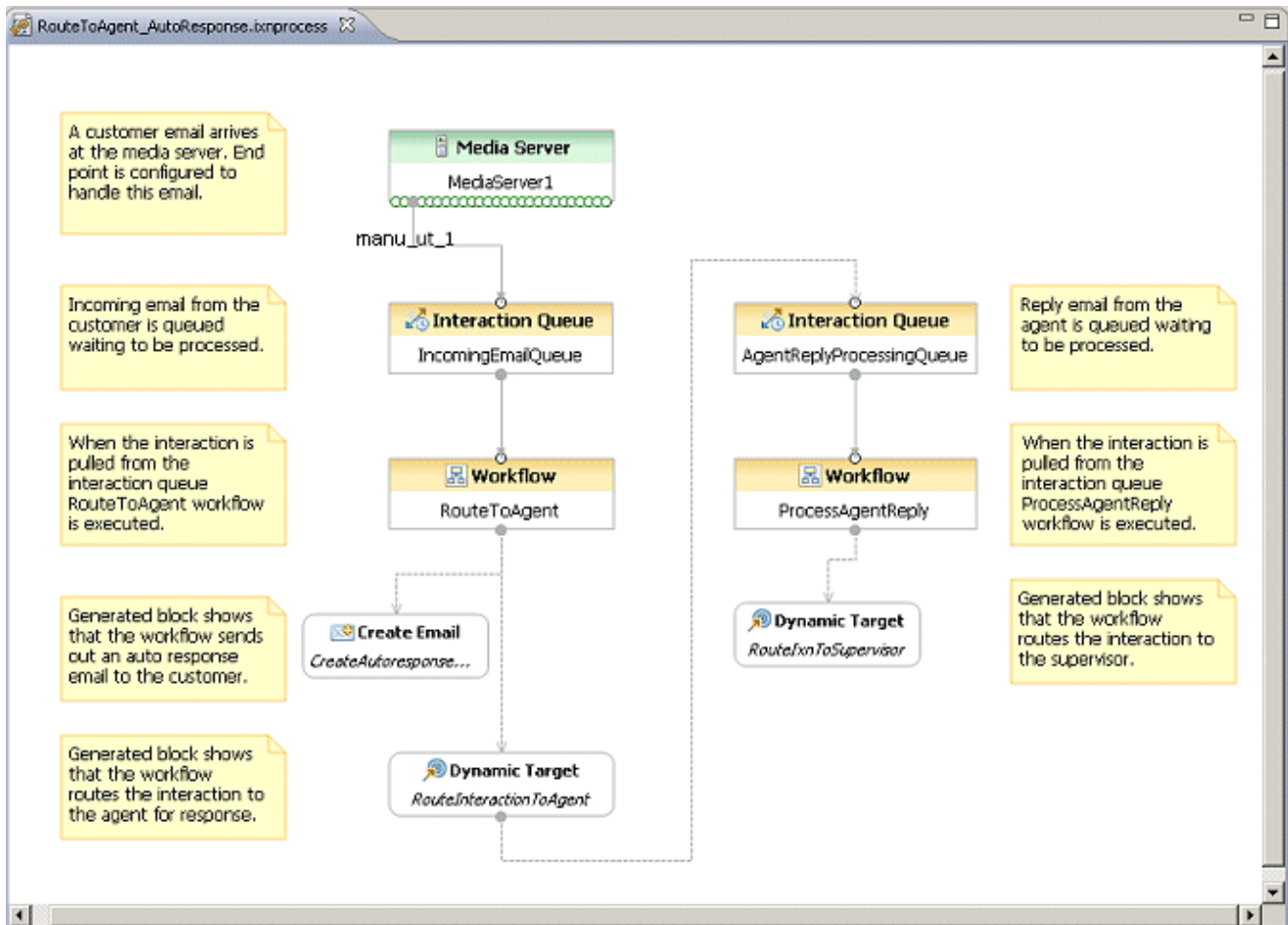

An IPD used for multimedia interactions:

- Visually presents and directs the flow of interactions through various processing blocks (**media servers, queues, and workflows**).
- Defines what happens to customer multimedia interactions from the point of arrival at your contact center to the point of completion.
- Can implement the procedures used by agents, supervisors, quality assurance, and other personnel in your company to accomplish your company's business objectives related to incoming multimedia interactions.

An IPD also enables visual configuration of the associated Configuration Server objects. When **connected to Configuration Server**, you trigger the actual Configuration Database update by using Composer's **Publish** operation. Publishing causes Composer to push out relevant subsets of the configuration information to Configuration Server. Here platform components can query for the information and use it for processing interactions.

SCXML File Creation

Composer expects IPDs (*.ixnprocess files) to be present in the Interaction Processes folder. This

folder is accessible from the Project Explorer. The code generation step creates SCXML files for the following types of diagrams:

- Interaction process diagram: One SCXML file is created for:
 - Each Interaction Queue block present in the diagram with the name IPD_<Diagram Name>_<Interaction Queue Block name>.scxml (Multimedia interaction scenarios).
 - Each Workflow block present in the diagram, that is not connected to an Interaction Queue block with the name IPD_<Diagram Name>_<Workflow Block name>.scxml (voice or interaction-less scenarios). Each of these files represents an entry point into this application and can be specified in the EnhancedRoutingScript object. This Script object should never point directly to a workflow or sub-workflow SCXML file.
- Workflow diagram, sub-workflow diagram: Both types of files have the .workflow extension. Code generation creates an SCXML file for each diagram with the same name as the diagram name.

The IPD SCXML file includes one or more workflow SCXML files which, in turn, can contain a hierarchy of sub-routine SCXML files. Orchestration Server combines all these related files into a single document and then executes the resulting combined SCXML document. Due to this reason, the line numbers mentioned in Orchestration Server logs may not match the line numbers in individual Composer SCXML files. See the Orchestration Server documentation for information on how to obtain access to this merged document.

Starting a New IPD

See [Starting a New IPD](#) when creating a routing application.

Executing an IPD

The following Genesys servers work together to execute an interaction processing diagram:

- For multimedia interactions, handles queue processing, delivery of interactions to selected resources, and invoking multimedia services. For information on Interaction Server, start with the *eServices/Multimedia 8.1 Deployment Guide*.
- (ORS) interprets the top-level SCXML document created as a result of the interaction processing diagram. For information on ORS, start with *Orchestration Server 8.1 Deployment Guide*.
- ORS provides the Genesys Functional Modules (Queue, Interaction, Voice Interaction, Dialog, Resource), which are described in the *Orchestration Server 8.1.3+ Developer's Guide*.

ORS sends requests to [Universal Routing Server](#), invoking actions from these modules based on its SCXML interpretation. URS then determines available resources (which may be another queue or the final target, such as an agent) where interactions can be delivered to and returns responses back to ORS with the resultant action information.

Creating Routing Applications

This section describes how to create routing applications, both in the workflow designer and in the editor after [workflow post installation configuration](#).

- [IPD Planning and Preparation](#)
- [IPD is Starting SCXML Page](#)
- [Creating a New Routing Project](#)
- [Creating the IPD](#)
- [Creating a New Workflow Diagram](#)
- [Using the SCXML Editor](#)
- [Using SCXML Templates](#)
- [Your First Routing Application](#)
- [Using URS Functions](#)

Also see the video below on one way (out of many) to create a routing strategy. This video demonstrates the use Composer's Project and diagram templates. To optimize viewing, use the video button at the bottom to expand to full-screen.

Creating a Simple Routing Strategy

[Link to video](#)

IPD Planning & Preparation

This topic discusses preparation and planning for creating an **interaction process diagram (IPD)** that will process multimedia interactions. An IPD for voice interactions contains only a single workflow block. When planning an IPD for multimedia processing, start by considering the basic stages in the interaction life-cycle. You can then design an IPD that encompasses all stages, just one stage, or multiple stages. This topic presents four basic stages, which are especially applicable to e-mail processing, but could apply to other media types as well. The stages are:

1. Pre-Route
2. Route-to-Agent
3. Review
4. Pre-Send

Each stage is summarized below. **Pre-Routing Stage** The main activities in the pre-routing stage of e-mail handling can potentially include:

- Determining whether an e-mail has already been processed by Genesys. This can be accomplished via the absence or presence of an Interaction Subtype Business Attribute assigned by Interaction Server.
- Classifying e-mails based on content analysis, which can assign a category code. Once a category code is assigned to an e-mail, you can configure other types of processing to occur based on the category code.
- Screening e-mails for certain words or patterns of words. Once a screening rule match occurs, you can configure other types of processing based on the match.
- Sending an acknowledgement and/or automatic standard response to the customer originating the e-mail.
- Determining the agent (if any) who previously handled the interactions related to this service.

Route-to-Target Stage This may or may not be an agent target. For example, the e-mail may be:

- Sent to a queue for submittal to other routing strategies and further processing.
- Sent to a queue for failed interactions.
- Forwarded outside the contact center to an expert with the expectation of getting a response back.
- Redirected to another agent without the expectation of getting a response back.
- Routed to an agent target for construction of a response.

Review Stage The reviewer could be a manager, supervisor, or QA Person. You may want to have two different types of quality assurance review:

- A supervisor review that checks the skills of the agent who constructed the response.
- An analysis that performs a sanity check; for example, to prevent sending out a bank account password in an interaction or to screen interactions for inappropriate language.

Pre-Send Stage The cycle of going from queue to routing workflow to queue can continue until the interaction reaches some final outbound queue. The pre-send stage performs last-minute quality checking and allows for attaching additional information to interactions when needed.

IPD Preparation

This section summarizes the preparatory steps for creating an IPD prior to actually creating, configuring, and placing blocks in Composer. It also describes the Configuration Database and Universal Contact Server Database objects that must exist first so they can be selected from Composer blocks.

1. Determine the interaction life cycle at your contact center.
2. Determine the media server, which will be referenced by the **Media Server block**. Check that the required **Endpoints** have been defined.
3. Determine which Composer blocks will be used in routing **workflows** reference by the **Workflow block** to perform the various processing required at each stage of interaction processing as described in the IPD Planning topic.
4. For each interaction processing stage, assign a name to the required IPD.
5. If you plan on having multiple IPDs **linked via workflows**, name the queues that will connect the workflows contained within each IPD.
6. Determine the selection criteria for extracting interactions from queues (**Views property** in the **Interaction Queue block**). For example, you may wish to extract certain interaction types earlier than other interaction types.
7. Create the required Knowledge Manager objects, such as categories and standard responses. For more information, see the *eService/Multimedia 8.0 Knowledge Manager Help*.
8. Create the required Configuration Manager/Genesys Administrator objects, such as media server Applications, Skills, Persons, Agent Groups, Places, Place Groups, and Business Attributes, just to mention a few. For more information, see the *Framework 8.1 Configuration Manager Help*.
9. Optionally, map Context Services attributes to Configuration Server Business Attributes. Once this is done, you can select a Business Attribute DB ID for a value in many **Context Services** block fields.
10. Create the routing workflow(s) that will perform the specialized processing tasks, which will be referenced by Workflow block(s).

Starting SCXML Page

The starting SCXML page for any Composer routing project is the SCXML page generated from an **interaction process diagram** (IPD) and not the SCXML page generated from a **workflow**. IPD SCXML pages internally include workflow SCXML pages. An **IPD** is therefore required for both voice and multimedia workflows. When an IPD diagram is **Published**, Composer sets the URL of the starting SCXML page in the resultant Script object of type Enhanced Routing.

When executing an IPD, the **Orchestration Platform** "merges" the IPD SCXML page and any included workflow SCXML pages to create a single page and then executes that page.

Note: One **Composer Project** may contain multiple IPDs. Both Java Composer Projects and .NET Composer Projects support IPDs.

Creating a New Project

When building any application in Composer, you first need to create a **Project**. A Project contains all the workflows and other files for your application. It also automatically creates the required **interaction process diagram**. By associating a callflow or workflow or other routing application with a Project, you enable Composer to manage all the associated files and resources in the **Project Explorer**.

The information below describes creating a new Java Composer Project. For information on creating a new .NET Composer Project, see [Composer Project Types and Directories](#).

Creating a Project

Before creating a new Project, you may wish to review [Your First Application DNIS Routing](#) for the sample GVP voice application, [Hello World Sample](#).

To create a new Composer Project:

1. In the menu bar, click the Create a Java Composer Project button. Or click the button for a **.NET Composer Project**. Or click the New button above the Project Explorer and select **Composer > Composer > Projects**.
2. In the Project dialog box, type a name for your Project.
3. If you want to save the Composer Project in your default workspace, select the **Use default location** check box. If not, clear the check box, click Browse, and navigate to the location where you wish to store the Composer Project.
4. Select the Project type:
 - **Integrated Voice and Route**. Select to create a Project that contains both callflows and workflows that interact with each other; for example a routing strategy that invokes a GVP voice application.
For a video tutorial on an Intergrated Voice and Route Project, see [Integrated Voice and Route Application](#).
For more information on both voice and routing applications, see [What is GVP and How Do Voice Apps Work](#) and [What Is a Routing Strategy](#), respectively.
Note: This selection grayed out if you have not enabled Composer's routing functionality as described in the [Hiding File Types](#) topic.
 - **Voice**. Select to create a Project associated with the GVP 8.x. This type of Project may include callflows, and related server-side files. For more information on this type of Project, see topic [What is GVP and How Do Voice Apps Work](#).
 - **Route**. Select to create a Project associated with the URS 8.x SCXML Engine/Interpreter. For more information on this type of Project, see topic, [What Is a Routing Workflow](#). This selection grayed out if you have not enabled Composer's routing functionality as described in the [Hiding File Types](#) topic.
5. Click **Next**.

6. If you want to use templates, expand the appropriate Project type category and select a **template** for your application. Templates are **sample applications** for different purposes. If you want to start from scratch, choose the Blank Project template and click **Next**.
7. Select the default **locale** and click **Next**.
8. Optional. If using the GVP ICM Adapter in a VoiceXML application, select the **Enable ICM** checkbox to enable integration. When checked, ICM variables will be visible in the Entry block. See the **ICM Interaction Data block** for more information.
9. Click **Finish**.

Composer now creates your new Project. Your new Project folder and its subfolders appear in the Project Explorer. The canvas area shows default.ixprocess tab for the interaction process diagram.

Creating the IPD

Note: Composer automatically creates a default IPD as part of new Project creation. You can also create an IPD on demand using the main toolbar button. This topic presents typical high-level steps for creating:

- [IPDs for Voice Workflows](#)
- [IPDs for Multimedia Workflows](#)

Notes:

- IPDs are not stored in Configuration Server. Your Workspace (Interaction Processes folder in Project Explorer) is the only location where these diagrams exist (and, of course, in source control if enabled).
- If a Composer Project contains a folder at `include/user`, then any files with extension `.js` will be included in the generated SCXML. This allows you to write custom ECMAScript and include it in the application.



Creating IPDs for Voice Workflows

An IPD for a voice workflow contains a single Workflow block. After [creating a new Project](#) (which automatically creates an IPD with a Workflow block), the typical high level steps are as follows:

1. Click the `default.ixprocess` tab on the canvas that will contain the IPD.

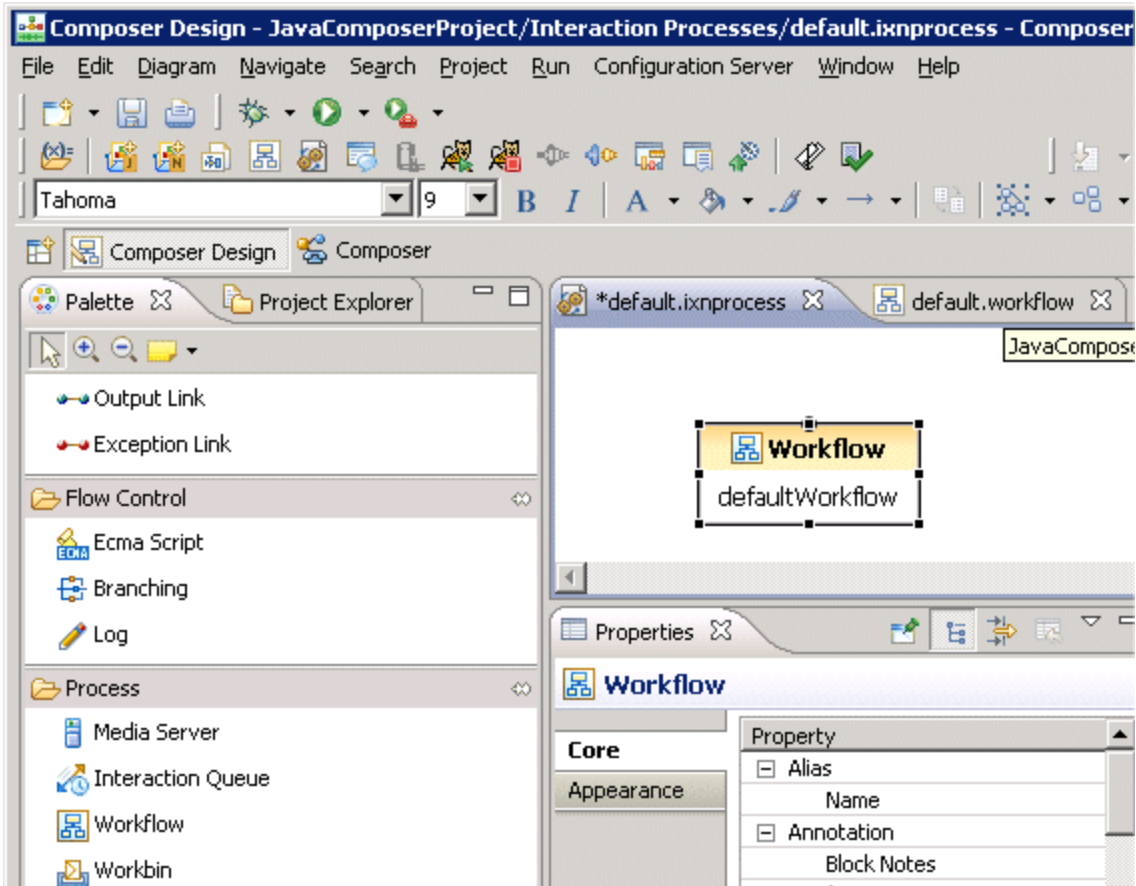
Note: You can change the name of an interaction process diagram file by right-clicking the file name in the Project Explorer and selecting **Rename**. This brings up a preview dialog. After accepting the change, the `default.ixprocess` tab reflects the name change.



2. Double-click the Workflow block to display its **properties** in the Properties tab below.
3. Opposite Resource, click under Value to display the  button.
4. Click the  button to open the Select Resource dialog box and select the empty workflow diagram. If you have not changed the name, this will be default.workflow.

Note: There is no need for a Media Server block or an Interaction Queue block when creating an IPD for a voice workflow.

5. Click the default.workflow tab on the canvas as shown above and **use the designer to develop your workflow diagram**. This includes saving and **validating**. For more information on developing a workflow, see the **Example Diagram** section in the Creating a New Workflow topic.
6. **Validate the code** and **Publish** your IPD diagram.
7. Generate the code by selecting **Diagram > Generate Code**, or by clicking the Generate Code icon on the upper-right of the Composer main window when the canvas is selected. Check the **Problems** tab for errors and fix any problems. If code generation succeeds, click **OK** at the confirmation dialog box. The SCXML code is generated in the src-gen folder. The generated file name in the src-gen folder will follow the format:

<ipd_diagram_name>_<workflow_block_name>.scxml Note: One file per voice/interaction-less (see **Interaction ID**) workflow block will be generated.

8. [Debug the workflows.](#)
9. [Deploy the Project.](#)

Note: Composer Diagram Preferences includes the following:

- **Prompt to Save before Publishing Interaction Process Diagram.**
- **Prompt to delete Published objects when Interaction Process Diagram is deleted.**

Creating IPDs for Multimedia Workflows

After [creating a new Project](#) (which automatically creates an IPD with a Workflow block), the typical high level steps for creating an IPD for multimedia interactions are as follows:

1. Click the default.ixprocess tab on the canvas that will contain the IPD.
2. Add a [Media Server block](#) that has at least one [Endpoint](#) defined to the canvas by double-clicking or dragging and dropping. Configure the Media Server block properties in the Properties view.
3. Add an [Interaction Queue block](#) to the canvas by double-clicking or dragging and dropping. Configure the Interaction Queue block properties in the Properties view. This includes defining at least one [interaction queue view](#).
4. Connect the Media Server Endpoint to the Interaction Queue block.
5. Click the default.workflow tab and [use the designer to develop your workflow diagram](#).
6. Click the default.ixprocess tab and open the Workflow block. Use the [Resource property](#) to point the workflow diagram you just developed.
7. Connect the view from the Interaction Queue block to the Workflow block.

The subsequent steps of adding additional blocks to complete the IPD or [linking IPDs with workflows](#) are user-defined and reflect your company's business logic. This includes saving and [validating](#). For example, you may choose to continue processing interactions in this IPD by repeating the process of sending interactions from workflows back to queues, using views to extract the interactions, and then sending the interactions for further specialized processing by other workflows.

8. [Validate the code](#) and [Publish](#) your IPD diagram.
9. [Generate the code for the IPD and workflow diagram](#) All generated files go into the src-gen folder of the Project.
10. Click the tab on the canvas that contains the IPD and generate the code. The generated file name in the src-gen folder will follow the format: <ipd_diagram_name>_<interactionqueue_block_name>.scxml

Note: One file will be generated for each interaction queue. Functionally these files will be equivalent. Generating one file per queue makes it easier to configure the application URL manually. As the developer, you will know the interaction queue you have submitted the interaction to and therefore can easily identify the correct SCXML page.

11. [Debug the workflows.](#)
12. [Deploy the Project.](#)

Manually execute any other configuration steps in Configuration Server using Genesys Administrator or Configuration Manager. For example, you must hook up your mailbox to send e-mails to the new end point defined in your e-mail server.

Generated Files

Multiple top level SCXML files are generated, one for each Interaction Queue connected to the Media Server block Endpoints. This allows different start states and different sessions for different interactions pulled from different Interaction Queues connected to the media servers. File names for the generated files use the following format:

- For IPDs that do not contain Interaction Queue blocks: IPD_<ipdname>_<Workflow block name>.scxml
- For IPDs that use interaction queues: IPD_<ipdname>_<InteractionQueue block name>.scxml

Each top level SCXML file for an IPD includes:

- All workflows (generated SCXML files) referred to by the Workflow blocks in the IPD.
- All workflows (generated SCXML files) referred to indirectly via Interaction Queues in other IPD's.

The SCXML file inclusion in the top-level document is done using <xi:include>. The workflow file name without the .scxml extension is used for the _prefix attribute.

Creating a New Workflow Diagram

Cheat Sheets

Composer provides a cheat sheet to walk you through the steps for building a routing strategy.

- In the **Welcome Screen (Help > Welcome)**, click the Composer link and select the Create a Routing Strategy tutorial. It will also describe the steps for how to simulate calls.
- If you are already inside the **workbench**, access the same cheat sheet from the Menu bar at the top by selecting **Help > Cheat Sheets > Composer > Routing Strategy**.

Adding a Workflow Diagram to a Project

To add a new workflow diagram to an existing Composer Project:

1. Click the **button** on the main toolbar to create a new workflow .
 - Or use the keyboard shortcut: Ctrl+Alt+R.
 - Or select **File > New > Workflow Diagram**.
 - Or right-click the Workflows folder in a Project and select **New > Other > Workflow Diagram**.
2. In the wizard, select the tab for the type of the workflow. There are two main types of workflows in Composer represented by wizard tabs:
 - **Main Workflow**: Used for the main application where the call will land or be transferred to from another application.
 - **Subworkflow**: Used for modularizing your applications. It is useful for structuring large applications into manageable components.
3. Select either **Main Workflow** or **Subworkflow**.
4. Select the type of diagram.
5. Click **Next**.
6. Select the Project.
7. Click **Finish**.
8. Create the workflow. [See Your First Application "DNIS Routing"](#) on how to get started.

Note: The condition expression for event-related properties in interaction process (IPD) and workflow diagrams are not XML-escaped when generating the SCXML code. For more information, see Troubleshooting [ORS Compile Errors and Non Escaped Special Charcters](#).

Using the SCXML Editor

The Composer SCXML editor is embedded/integrated within the user interface and are made available to you whenever an .scxml file is created or accessed within Composer.

Creating a New Project

Follow the steps below after you have created a **Project**.

1. Switch to Composer **perspective**.
2. Click the File menu and select **New > SCXML File**. The Create New SCXML File dialog box opens.
3. Select the Project.
4. Name the file. You now have two choices:
 - If you do not wish to use a template, click **Finish**.
 - To use a template, click Next, Use SCXML Template, select the template, and click Finish.

The Workflows folder in the Project Explorer shows the name of the file under your Project. Composer displays the SCXML Editor.

5. Create the code.

Open an Existing or Imported File

The SCXML editor also opens whenever you open an existing .scxml file, whether previously created as described above, or previously **imported** into Composer. Open an existing file as follows:

- Select **File > Open File** and navigate to the file to open, OR

Open a Project's src or src-gen folder in the Project Explorer, then double-click the file to open it in the editor.

Using SCXML Templates

To create a new SCXML file for an existing [Project](#):

1. Select from the menu: **File > New > Other**
2. Select from Wizard: **Composer > Other > SCXML file.**
3. Select the Project name for the new file.
4. Type a file name for your new file and click **Next**. The Select SCXML Template dialog box opens. The **Use SCXML Template** check box is selected.
5. Select a template to preview.
6. Click **Finish**. The SCXML editor opens with your new file.

Also see [ProjectTemplates](#).

Your First Application: Routing Based on DNIS or ANI

The steps below lead you through creating a simple routing strategy workflow for voice interactions. This workflow routes incoming calls based on the number dialed by the customer (DNIS) English-speakers dial one number; Spanish-speakers dial another number. Assume this number is attached to the interaction when it arrives at the contact center.

Note: The same type of Composer configuration could also be used to route incoming calls based on the originating phone number (ANI).

Starting the Workflow

After **creating a new Project** in Composer Design or Composer **perspective**:



1. Click the  button on the main toolbar to create a new workflow and continue with step 2.
Alternatives:

- Select **File > New > Workflow Diagram** or select **File > New > Other**. In the New dialog box, expand **Composer > Diagrams**. Select **Workflow Diagram** and click **Next**. Continue with step 2.
 - Or use the keyboard shortcut: Ctrl+Alt+R and continue with step 2.
2. In the Main workflow tab, select **Empty Diagram** and click **Next**.
 3. Select the parent Project.
 4. Name the diagram (must have an extension of .workflow) and click **Finish**. The Workflows folder in the Project Explorer shows the name of your diagram under your Project.
 5. Select the Workflows folder in the Project you just created.
 6. Build the diagram as described below.

Creating the Workflow Diagram





For general guidelines on placing, configuring, and connecting blocks, see the [Using the Designer](#) topic.

1. [Connect to Configuration Server](#). You can also use the keyboard shortcut: Alt+I+C.
2. [Create a new project](#) called "DNIS_Routing."
3. Add the following blocks from the Palette to the canvas area: [Entry](#), [Branching](#), [Target](#) (add two), and

Exit.

4. Use the ConnectionLinks to connect the Entry block to the Branching block.

Typically, you start by segmenting incoming interactions to take different paths in the workflow. For example, you could segment by date, time of day, day of week, number dialed (DNIS), or originating number (ANI), just to mention a few examples. You could also segment based on a logical expression that you create in Expression Builder. You can use the Branching block for this purpose as described below.

1. Select the Branching block to cause the lower Properties tab to show the fields associated with the block. An alternative method is to right-click the Branching block and select **Show Properties View** from the shortcut menu.
2. In the Properties tab, opposite the **Conditions** field, click under the **Value** column. This brings up the  button.
3. Click the  button. This brings up the Branching Conditions dialog box.
4. In the Branching Conditions dialog box, select **Add**. Condition0 appears under **Node Name**.
5. Change Condition0 to 8004662809.
6. Click opposite 8004662809 under **Expression**. This brings up the  button.
7. Click the  button to bring up Expression Builder.



Using Expression Builder

We will now define two sample expressions in **Expression Builder**. In the case of the Branching block, the expressions will define the branching conditions that will cause interactions to take different paths in the strategy.

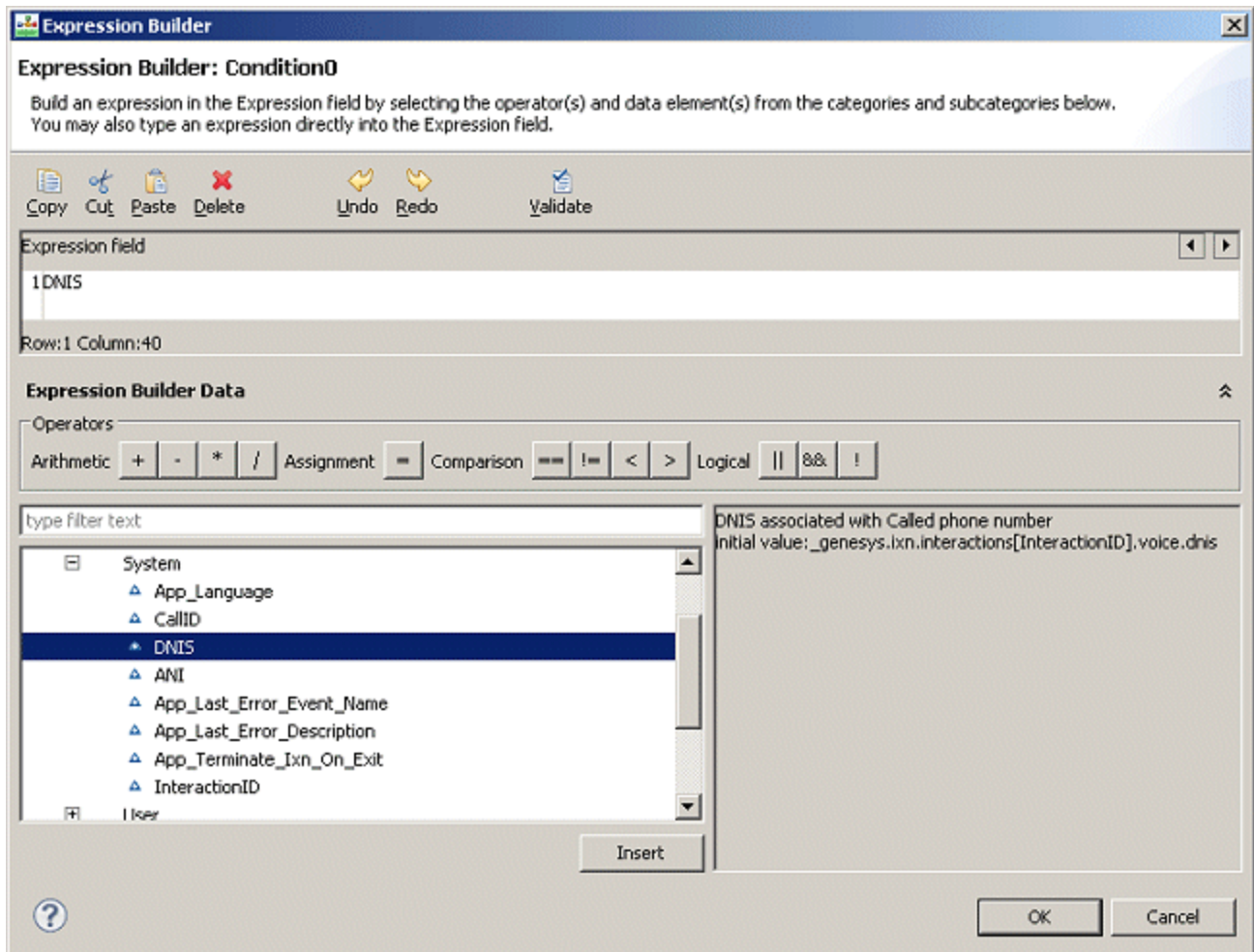
1. Click the  button on the right to expand Expression Builder.
2. Expand **Workflow variables** followed by **System**.
3. Double-click **DNIS**. Expression Builder appears as shown below.



4. Continuing with this example, note that "DNIS" appears under Expression field opposite 1. ANI and DNIS correspond to URS functions getDNIS() and getANI(). These functions can be used in a call or workflow to read the DNIS and ANI of the call. ANI is the originating phone number (user name of the calling SIP phone). DNIS is the number that the user dialed (provisioned number for the application, or "dialog" if you're making the call through the **debugger**).
5. Opposite **Operators**, click the button for the equal sign (=). data.DNIS= now appears under Expression field.
6. Type a single quote after the equal sign.
7. Type the 800 number. For this example, use 8004662809.
8. Type a single quote after the number. Expression field now shows data.DNIS='8004662809'.
9. Click the  button to validate the expression. No syntax error found appears above.
10. Click **OK** to close the Expression Builder dialog box and return to the Branching Conditions dialog box.
11. In the Branching Conditions dialog box, select **Add**. This time Condition1 appears under **Node Name**.
12. Change Condition1 to 8008361447.

13. Click opposite 8008361447 under **Expression**. This brings up the  button.
14. Click the  button to bring up Expression Builder.
15. Repeat the Expression Builder steps to add the second expression: DNIS='8008361447' and click **OK**. The Branching Conditions dialog box now appears as shown below.

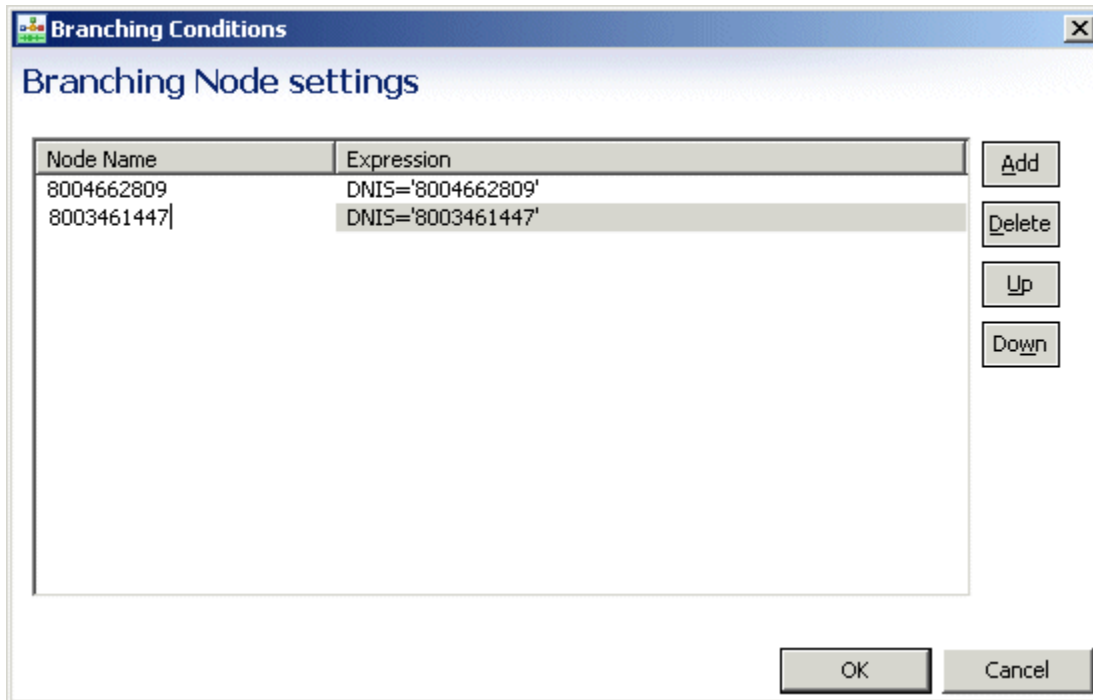

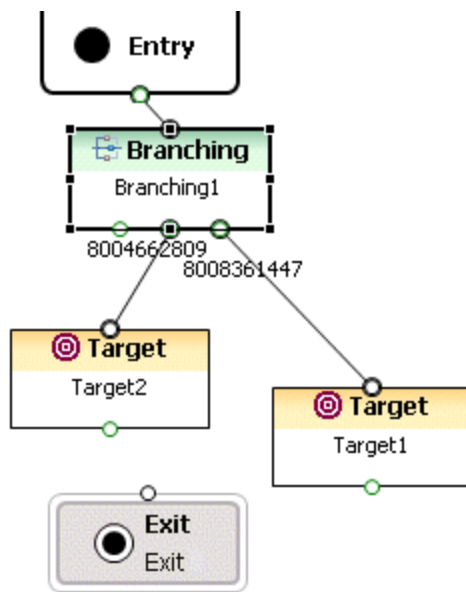

16. Click **OK** in the Branching Conditions dialog box. The Branching block now shows three ports.
 - The second and third ports correspond to the conditions defined in the Expression Builder.
 - As described ahead, the first port could be used for default routing or another purpose.
17. Connect the second port to the Target block below it.
18. Connect the third port to the Target block below it. The routing strategy diagram (8.0.3) now appears as shown below.



19. Save the diagram as it exists so far by selecting **File > Save**.

Target Selection

This section describes how to configure the Target blocks in our example strategy diagram. Targets refers to routing target objects that exist in your Configuration Database. For example: Agent, Agent Group, ACD Queue, Place, Place Group, Route Point, Skill, or Variable.

1. Click a Target block to cause the lower Properties tab to show fields. An alternative method is to right-click the block and select **Show Properties View** from the shortcut menu.
2. In the Properties tab, opposite the **Name** property, type EnglishAgents. The name must start with an underscore or a letter.
3. Click under **Value** opposite the Targets property to display the  button.
4. Click the  button. The Targets dialog box opens.
5. Click **Add** in the Targets dialog box.
6. Click under Type to display a down arrow.
7. Click the down arrow and select the target type. Available selections are: **Agent, AgentGroup, ACDQueue, Place, PlaceGroup, RoutePoint, Skill, or Variable**.
8. Select **AgentGroup**. **AgentGroup** appears under **Type**.
9. Click under the **Name** field to display the  button.

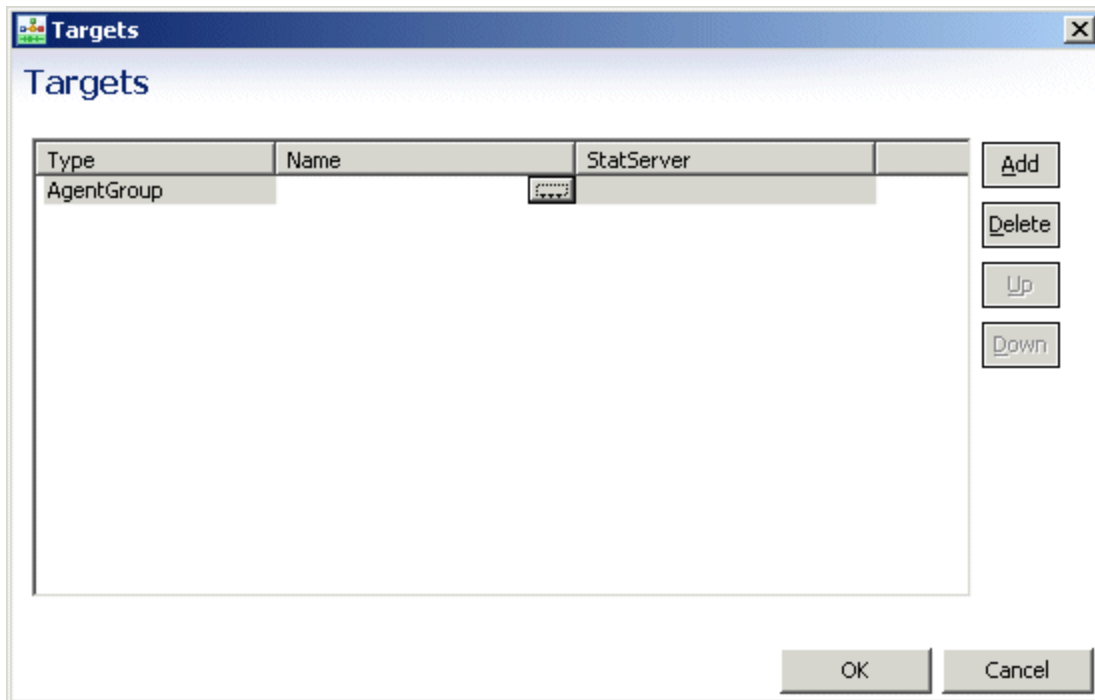

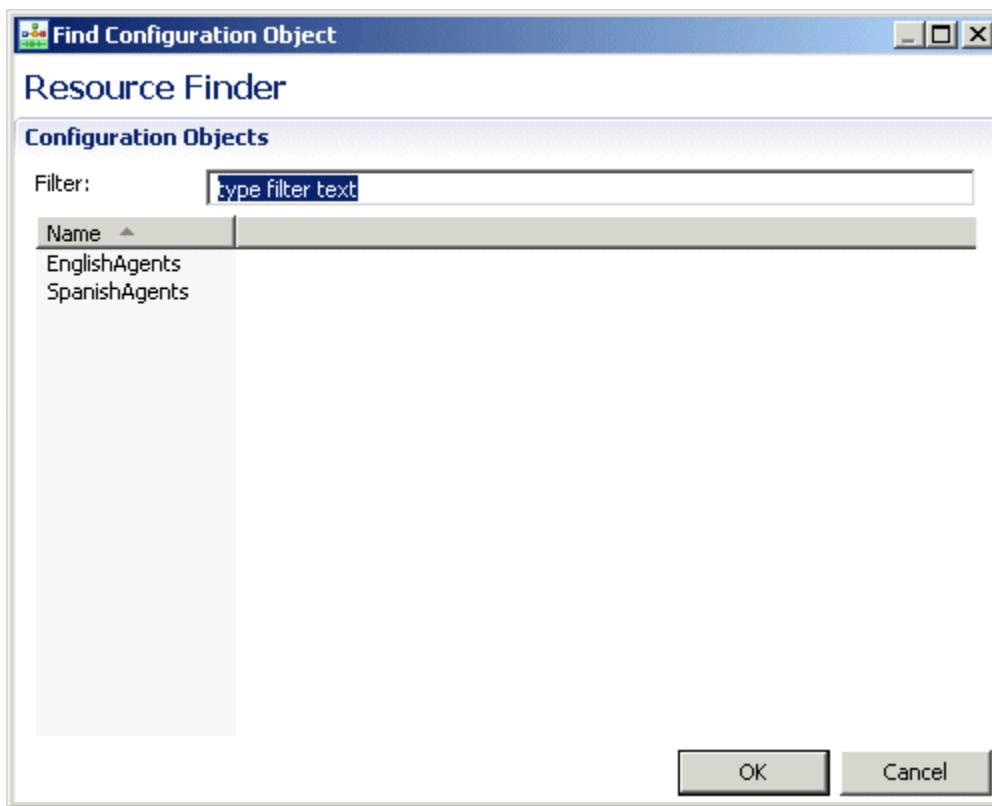

10. Click the  button. Targets of type **AgentGroup** appear for selection. An example is shown below.



11. Select a routing target. In this case, select **EnglishAgents** and click **OK**.
12. Click **OK** in the Targets dialog box.

Routing Based on the Value of a Statistic

You have the option of instructing Universal Routing Server to use the value of a statistic during target selection. For example, you may wish to route to an agent who has been in a "Ready" state for the longest period of time.

1. If you have not already done so, make sure the **Configuration Server preference** is set to control whether or not to create Router predefined statistics when connecting to the Configuration Server.
2. In the Properties tab, opposite the **Statistic** property, click under the **Value** column to display the  button.
3. Click the  button to open the Statistics dialog box.

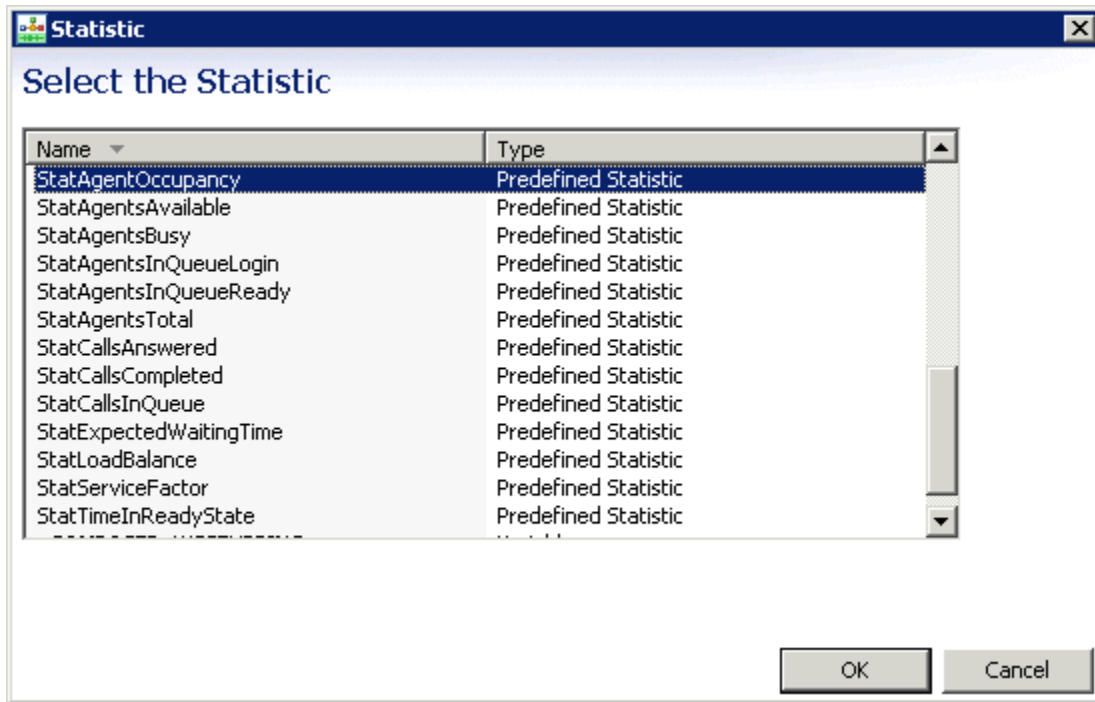

You can select from the following statistics:

CallsWaiting	RStatLoadBalance	StatTimeInReadyState
InVQWaitTime	StatAgentsTotal	StatAgentsAvailable
PositionInQueue	StatCallsAnswered	StatAgentsBusy
RStatLBEWTLAA	StatCallsCompleted	StatAgentsInQueueLogin
RStatCallsInQueue	StatCallsInQueue	StatAgentsInQueueReady

RStatCallsInTransition	StatEstimatedWaitingTime	StatAgentLoading
RStatCost	StatExpectedWaitingTime	StatAgentLoadingMedia
RStatExpectedLBEWTLAA	StatLoadBalance	StatAgentOccupancy
RStatExpectedLoadBalance	StatServiceFactor	

For a definition of each statistic, refer to the chapter on routing statistics in the *Universal Routing 8.1 Reference Manual*.

4. For the sample strategy, select StatTimeInReadyState.
5. In the Properties tab, opposite the Statistics Order property, click under the **Value** column to display a drop-down menu.
6. Select **Max** from the drop-down menu since we want the agent who has spent the maximum amount of time in a Ready state. You have no finished configuring the first Target block.

Adding Additional Blocks and Connecting

1. Repeat the steps in the **Target Selection** section to define properties for the second Target block for Spanish-speaking Agents.
2. Repeat the steps in the **Target Selection** section to add a third Target block named DefaultRouting for default routing where you route to an Agent target type.
3. Connect the three Target blocks to the Exit object. The routing strategy diagram now appears as shown below.

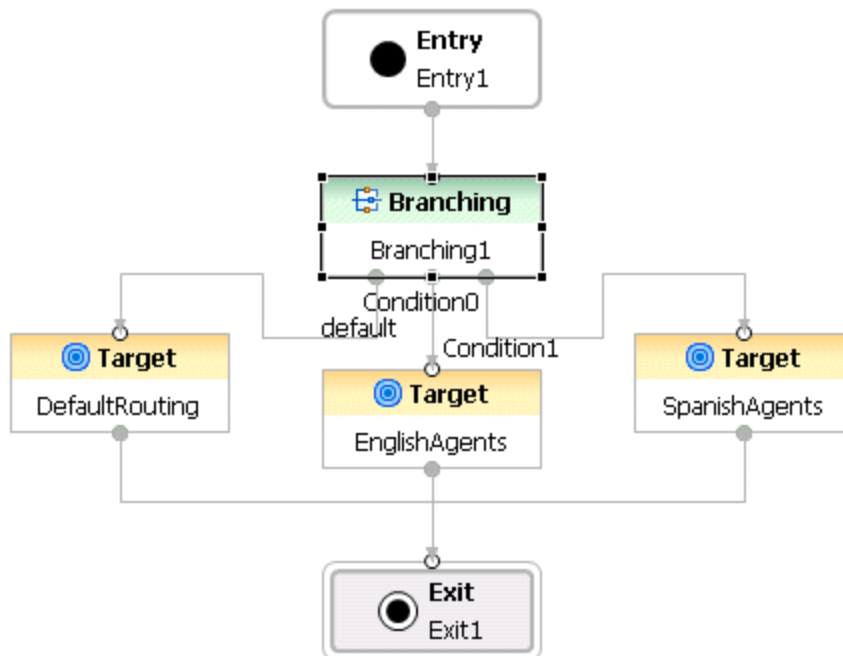

YourFirstApp8.gif

Saving

1. Save the diagram as it exists so far by selecting **File > Save**. You will not be able to generate code if you do not save the file.
2. If you have set your [Configuration Server preferences](#) to do so, validate the code by selecting **Diagram > Validate**.

You can also click the Validate icon  on the upper-right of the Composer main window when the workflow canvas is selected. The Problems tab shows the results of validation for this particular Resource. Fix any problems before continuing.

Generating Code

1. Generate the code by selecting **Diagram > Generate Code**, or by clicking the Generate Code icon  on the upper-right of the Composer main window when the canvas is selected. Check the Problems tab for errors and fix any problems. If code generation succeeds, click **OK** at the confirmation dialog box. The SCXML code is generated in the src-gen folder.
2. Test the workflow.

3. **Deploy the workflow.**

Using URS and ORS Functions

Composer's [Expression Builder](#) allows you to use SCXML elements and extensions as described the [Orchestration Server Developer's Guide](#) as well as [Universal Routing Server \(Workflow\) functions](#).

Expression Builder opens from many blocks; to name a few:

- [Assign--Assign Data Property](#)
- [Branching--Conditions Property](#)
- [ECMAScript \(for workflows\)--Script Property](#)
- [Entry--Variables Property](#)
- [Log--Logging Details Property](#)
- [Looping--Exit Expression Property](#)

Using one or more of the above blocks in a workflow gives access to functions for SCXML-based strategies. The [_genesys](#) subcategory is where you will find modules that access Genesys-platform related objects, properties, and functions. Starting with Release 8.1.410.14, Composer exposes `SetIdealAgent` and `GetIntegerKey()` URS equivalent functions in Expression Builder.

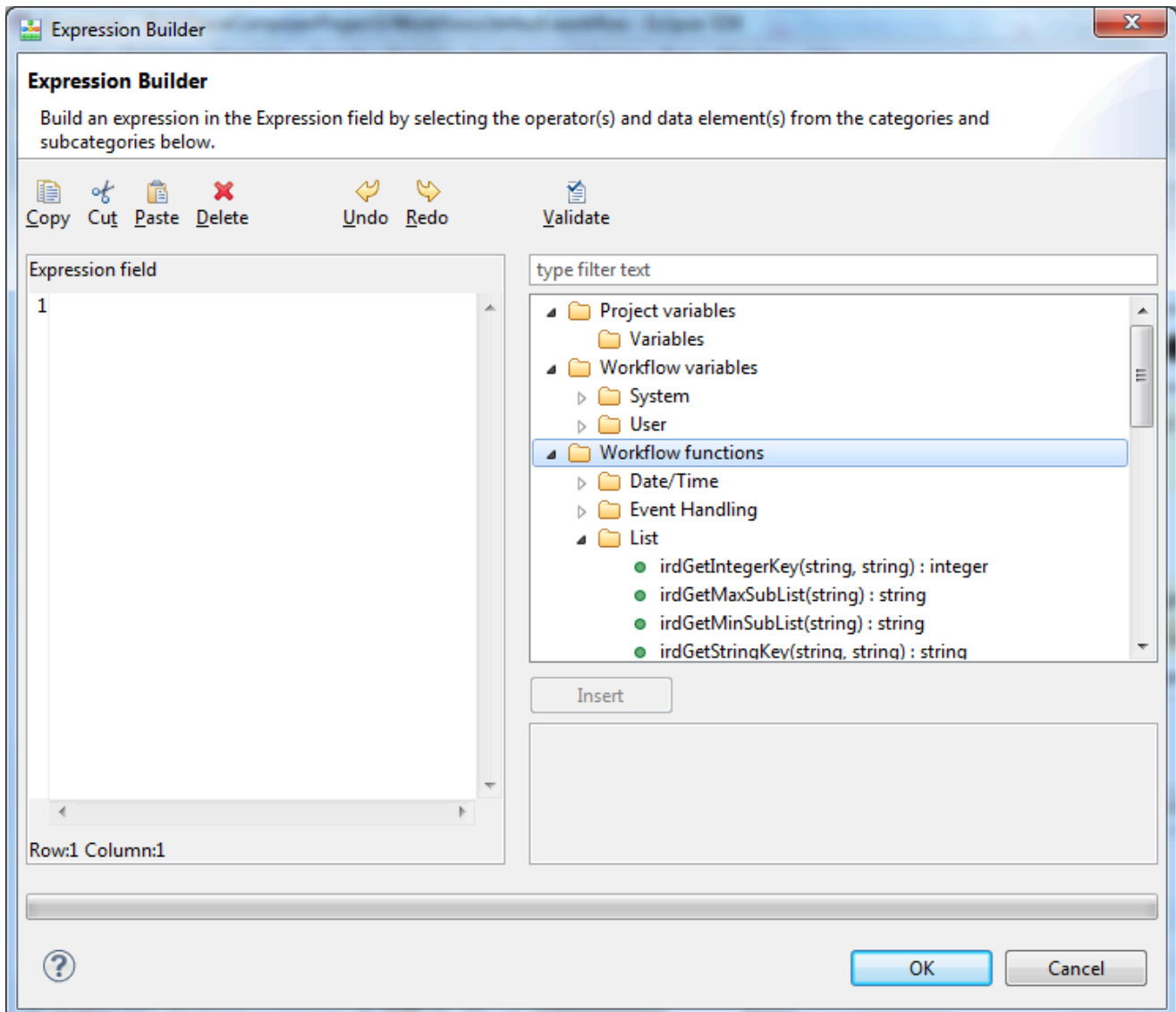

Below is summary information on certain functions accessible via Expression Builder.

Interaction Priority

URS always puts interactions into waiting queues according to their priorities. The `priorityTuning` function defines how URS handles interactions with the same priorities. By default, interactions with the same priority are ordered according to the time the interaction began to wait for some target.

- `useAge` parameter (true or false). If true, URS uses the time the interaction was created instead of the time interaction is placed into the waiting queue. Age of interaction is usually the time that URS starts the strategy for the interaction.
- `usePredict` parameter (true or false). If true, then URS calculates the estimated time for the interaction to be answered and will use this time instead of the time that the interaction has already

waited.

- useObjective parameter (true or false). This parameter works with the URS use_service_objective option (*Universal Routing 8.1 Reference Manual*), which allows you to scale the time interval for processing different interactions. If this option set to true, URS scales the time interval that the interaction waits (or is going to wait) according to the Service Objective of the interaction

If two interactions wait the same time, such as 60 seconds, but interaction #1 has a Service Objective of 30 seconds and interaction #2 has a Service Objective of 120 seconds, then URS puts interaction #1 ahead of interaction #2 in the queue ($60/30 > 60/120$). The figure below shows how to access the priorityTuning function in Expression Builder.

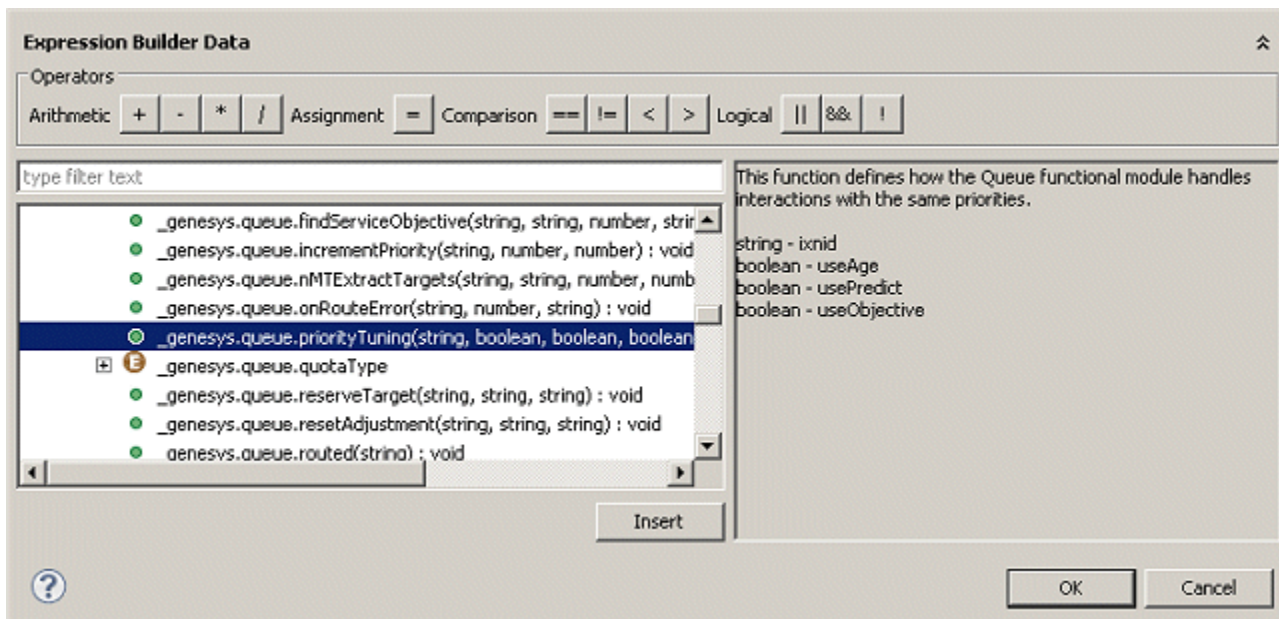

- For more detailed information on using this function, see the *Universal Routing 8.1 Reference Manual* and the *Universal Routing 8.1.Routing Application Configuration Guide* located on the [Universal Routing Wiki](#).
- For information on Orchestration Server functions, see Orchestration Extensions and Core Extensions topics in the *Orchestration Developers Guide*.

Routing Block Palette Reference

When you **create an application**, Composer's **palette** contains the diagram building blocks. The block categories that appear depend on what **tab** is selected above the design area or what workflow or callflow is selected in the Project Explorer. For example, to see blocks for creating GVP voice applications, click a ***.callflow** tab. To see blocks for creating routing applications, click a ***.workflow** tab, such as **default.workflow**.

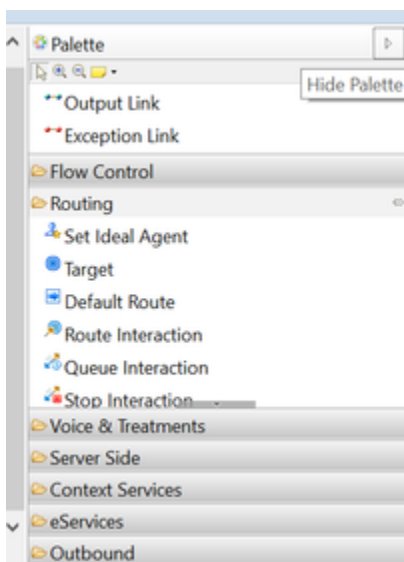

The palette contains the link tools, and various categories of blocks used to build routing workflow diagrams:

- **Output Links** are used to connect blocks in the order that the application should follow. **Exception** links indicate error conditions.
- **Flow Control Blocks**. Use to control interaction flow control within a workflow diagram.
- **Routing Blocks**. Routing blocks specify a routing action to be performed with the current interaction, such as sending an interaction to a specific agent group.
- **Voice Treatment Blocks**. Voice Treatment blocks specify an action to be performed with the current interaction, such as playing music for the caller.
- **Server Side Blocks**. Server-Side blocks provide the ability to interact with internal and external custom server-side pages, Web Services, and URLs. These blocks can be used to exchange data like VoiceXML and SCXML variables, JSON strings between GVP interpreter, and custom server-side pages.
- **Context Services Blocks**. Context Services refers to an optional capability of Universal Contact Server and its Universal Contact Server (UCS) Database, a repository of customer-related service, and interaction-centric data (current and historical) from Genesys and third party sources.

- **eServices Blocks.** Use to create a routing workflow that performs specialized processing of multimedia (non-voice) interactions.
- **Outbound Blocks.** Use to support Genesys Outbound Contact, a product for creating, modifying, running, and reporting on outbound campaigns for proactive customer contact.
- **Interaction Process Diagram Blocks** appear when such a diagram is selected. Use to provide a high level view of how multimedia routing interactions flow through various components like media servers, interaction queues, workbins, and workflows. In addition, an IPD functions as the starting SCXML page for both voice and multimedia interactions.

Tip

Should you accidentally cause the palette to disappear, click the Hide/Show Palette button.

Interaction Process Diagram Blocks

The following blocks can comprise an **interaction process diagram (IPD)**:

- **Interaction Queue block** to define or select a multimedia (non-voice) interaction queue in an interaction process diagram and to create Views, which defines conditions for pulling interactions out of the queue for submittal to workflows.
- **Media Server block** to get interactions of a particular media type (other than voice) into an interaction process diagram.
- **Workflow block** to point to a workflow resource (workflow diagram or SCXML file) to which interactions should be sent for processing.
- **Workbin block** to define a temporary storage area called a workbin, which is accessible from the agent desktop.
- **Flow Control blocks** to support multiple views per interaction queue, the following Flow Control blocks are available when creating an IPD: Branching, ECMAScript, Log.
- **Workflow-Generated Blocks**

Working with IPDs

Information on working with IPDs is presented below.

- [IPD Overview](#)
- [Starting a New IPD](#)
- [Interaction Queue Views](#)
- [Linking IPDs with Workflows](#)
- [Publishing Updates](#)

IPD Differences Voice and Multimedia

There is a difference between interaction process diagrams (IPDs) used for voice-only interactions and IPDs used for multimedia interactions.

- An IPD for multimedia interactions will contain [Interaction Queue](#), [Media Server](#), and [Workflow](#) blocks and possibly multiple instances of each block depending on the design.
- An IPD for voice interactions will only contain a Workflow block that points to a single workflow resource.
- An IPD for multimedia interactions may contain [workflow-generated blocks](#) whereas an IPD for voice interactions will not show these nodes.

For more information, see:

- [Example Multimedia Workflow](#)
- [Starting SCXML](#)

Starting a New IPD

Use these instructions after reviewing the [IPD Planning and Preparation](#) topic. Before starting a new IPD, you may wish to [Connect to Configuration Server](#) (optional). You can do this now or during the validation phase. When not connected, Configuration Database objects do not appear for selection in Composer dialog boxes; you must know the names in advance.

Method #1: Create a New Java Composer Project

1. [Create a new Java Composer Project](#). In Composer Design [perspective](#), this automatically creates an Interaction Processes folder and default.ixprocess file in the Project Explorer. It also automatically creates the following tabs on the canvas:

- default.ixprocess
- default.workflow

The default.ixprocess tab contains a starting Workflow block. The Palette tab shows the [Media Server](#), [Interaction Queue](#), and [Workflow](#) blocks. It also access certain Flow Control blocks.

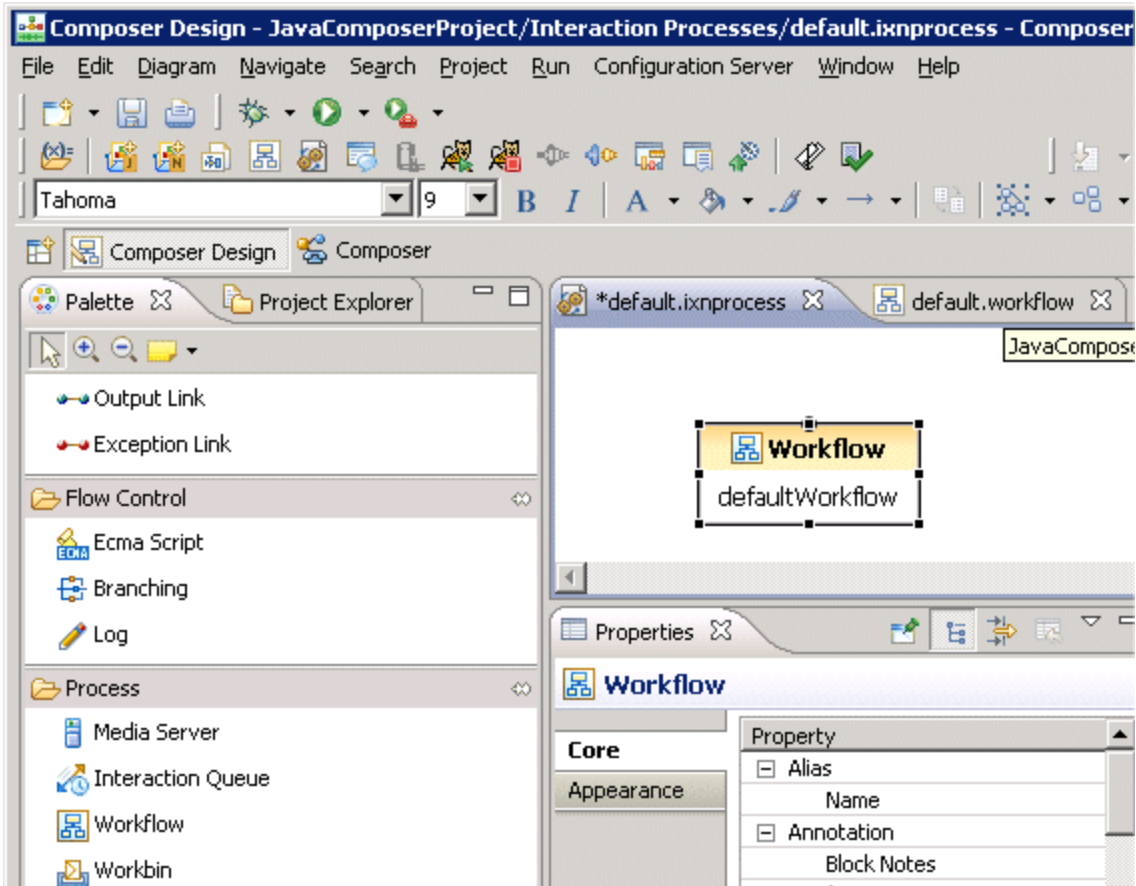

You can rename the IPD at any time by right-clicking the `default.ixnprocess` file in the Interaction Processes folder in the Project Explorer and selecting **Rename**. The renaming operation does not result in any changes being written to Configuration Server.

Method #2: New IPD Diagram Wizard

1. Bring up the wizard. There are various ways:
 - Click the Create New Interaction Process button on the toolbar.
 - Or select **File > New > Other > Composer > Diagrams > Interaction Process Diagram**.
 - Or in the Project Explorer > Right-click > **New > Other > Composer > Diagrams > Interaction Process Diagram**.
2. Name the IPD
3. Select or create the associated Project.
4. Click **Finish**.

Composer creates an Interaction Processes folder and default.ixprocess file in the Project Explorer. It also automatically creates default.ixprocess and default.workflow tabs on the canvas. The default.ixprocess tab contains a starting Workflow block. The palette shows the **Media Server**, **Interaction Queue**, and **Workflow** blocks. Note: An IPD does not use Entry or Exit blocks.

Tip

To display the IPD properties below, select an *.ixn.process tab above the design area, then click inside the design area,

An IPD contains the following properties:

Name Property

This property shows the name of the diagram. An IPD diagram can be renamed at any time. The renaming operation will not result in any changes being written to Configuration Server.

Events Property

With the .ixnprocess tab selected, click the empty space in the IPD to see Events in the Properties view.

The Events property (which replaces the 8.1.2 Wait for Event property) works with the Interaction ID property in Routing and certain eServices blocks. You select/enter the event(s) that the generated code will wait for before the workflow code is invoked. If unset, the IPD code will not wait for any event before invoking the workflow code. ORS will transition on the first event received. The Application does not need to receive all declared events to transition to the next block.

Starting with Release 8.1.400.33, Composer supplies default handler sets (voice, multimedia, interaction-less processing) and a **Custom** option for customizing handlers. You can change the set at any point of time and generate code. Pre-defined sets are non-editable and should be used for specific media processing. The **Custom** type can be used to customize the handlers. The Configure Events dialog box, which opens from the Events property, is shown below when interaction.added is selected.

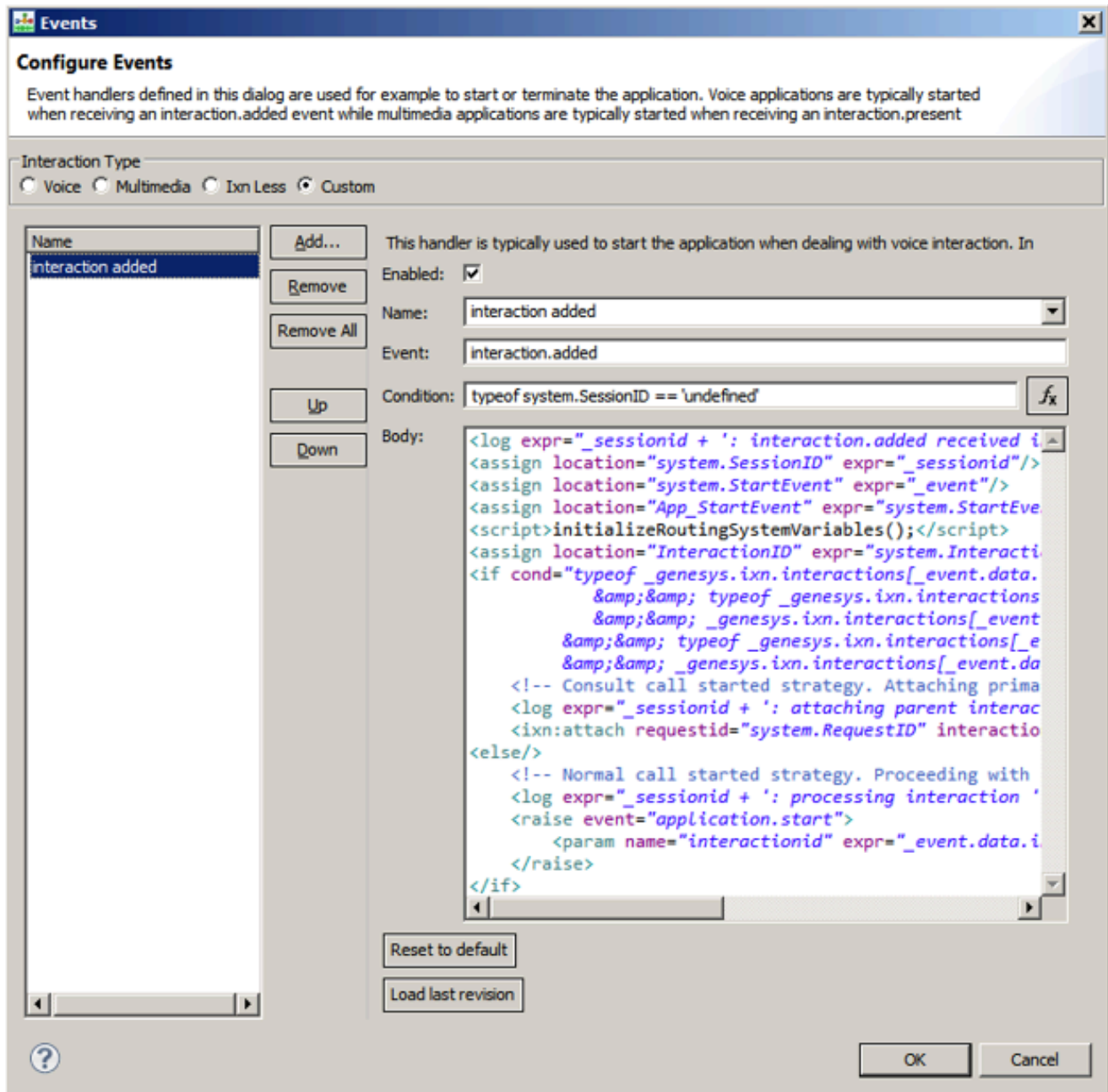

Refer to [Intra Version Upgrades](#) for event upgrade logic.

Event Handlers

All system handlers run into the system thread of the application while the workflow generated code runs into the user thread of the application.

Event handlers can control the lifecycle of the user thread by raising the application.start event (to start the application, see the interaction added event handler) or the application.exit event (to

terminate the application, see the `interaction.deleted` event handler).

To define this property in case of "interaction-less" processing (defined below), you may:

- **Wait for a user-defined event:**
 - Add a new Event item in the Events property list.
 - Specify the appropriate Event name.
 - In the body of that event, add the code: `<raise event="application.start">` to start the user thread (to run the workflow SCXML).
- **Start the application without waiting for any event:**
 - Remove all Events items
 - Or disable all Events items
 - Or in the Events dialog box, add the predefined "interaction-less processing" event (or any similar event having no Event AND no Condition defined).



In addition to catch all errors, Composer defines the following events:

- `interaction.present` or `interaction.added`. This property will be used by default as a value of the IPD/Events property.
- `interaction.onmerge`. This event will be caught by the generated IPD SCXML. The value of the variable `system.InteractionID` will be updated when the transfer is completed. The parent or primary interaction ID will be referred to instead of the consult interaction ID.
- `interaction.deleted` (active interaction id). This event will be caught by the generated IPD SCXML. Default behavior will be to exit the session. Default behavior can be overridden if `interaction.deleted` is handled in the workflow diagram.
- `interaction.deleted` (consult interaction id). This event will be caught by the generated IPD SCXML. Default behavior will be to exit the session if the parent interaction is gone or to do nothing otherwise. Default behavior can be overridden if `interaction.deleted` is handled in the workflow diagram.

Note: The condition expression for event-related properties in interaction process (IPD) and workflow diagrams are not XML-escaped when generating the SCXML code. For more information, see [Troubleshooting ORS Compile Errors and Non Escaped Special Charcters](#).

Interaction-less Processing

In the case of "interaction-less" processing (for example, see the [Force Route Block Interaction ID Property](#)), you can start an ORS session using the ORS REST API and then decide either not to wait (no Wait For Event defined) or to wait for a user-defined event. The ORS REST API allows you to send an event to a particular ORS session. To define this property:

1. Click under Value to display the  button.
2. Click the  button to open the Wait For Event dialog box.
3. Do one of the following:
 - Leave `interaction.present` to keep the default value, the system variable `InteractionId`, which will be initialized automatically in this case.

- Click Add and select from the list of SCXML events or enter the event name. After selecting an event, the dialog box displays a description of the event.

A system variable, AppStartEvent, will be generated in the IPD <datamodel>, which will be initialized to the contents of the specified start event. If unset, the variable will be set to undefined (not the string undefined).

- If necessary, click Remove to clear a selected event.

4. Click OK.

Created By Property

To be filled in by the user/author of the document.

Created On Property

Auto-populated by Composer to indicate the timestamp when the diagram was created.

Designed Using Property

Auto-populated by Composer to indicate version of Composer used to create this diagram.

Last Modified By Property

Provided by the user to indicate who updated the diagram last.

Last Modified On Property



Filled in by Composer when the diagram is modified.

Version Property

Provided by the user for versioning purposes during development.

Namespaces Property

Use to refer to custom namespaces in the generated code. To define this property:

1. Click under Value to display the  button.
2. Click the  button to open the Namespaces dialog box.
3. Click Add.
4. Enter the namespace prefix (see example below)
5. Enter the namespace URL (see example below)
6. Click OK.

When an event is sent to an ORS session via http, a response can be sent back from the session via http by using the `ws:response` tag as shown below. `<ws:response requestid="_data.reserveSendId" resultcode="JSON.stringify(resultReserve)" />`
Namespace: `xmlns:ws=[http://www.genesyslab.com/modules/ws http://www.genesyslab.com/modules/ws]`

Extensions Property

This attribute allows arbitrary attributes to be added to the root `<scxml>` element and is used by Orchestration Server to control persistence, session recovery, and other functionality.

Note: Composer-generated SCXML applications do not support the `w3c` value for the `_transitionStyle` extension attribute.

Refer to `<scxml>` element, `_transitionStyle` extension attribute in the SCXML Language Reference section of the [Orchestration Server Developer's Guide](#) for details.

Read Context Property

This is the counterpart of the Pass Context property in the [Routing Blocks](#). The value of this property is true or false. When true, the application will try to read the URL of the originating session from the interaction's User Data. If that URL is defined, it will then attempt to fetch the context from the originating [Orchestration Session](#).

Session Persistence Property

With the `.ixnprocess` tab selected, click the empty space in the IPD to see Session Persistence in the Properties view.

Select true or false. Use this property to set the `_persist` attribute of the `<scxml>` tag when

generating the SCXML code. For more information, see the `<scxml>` element Attribute Details, SCXML Language Reference section, in the [Orchestration Server Developer's Guide](#).

Deleting Blocks

IPD diagram non-linked blocks can only be deleted directly from the IPD Diagram canvas. To delete the linked blocks, go to the corresponding workflow diagram and delete or modify the routing blocks.

Interaction Queue Block

Note:

- Starting with 8.1.4, Composer-created SCXML-based routing applications are assigned to Views instead of being assigned to interaction queues (as in previous releases) and use a Submitter object for this purpose. This change enables enhanced **pulling of multimedia interactions from interaction queues**.

The Interaction Queue block is used only for multimedia workflows. Use it to define or select a multimedia (non-voice) interaction queue in an **interaction process diagram** and to create **Views**, which defines conditions for pulling interactions out of the queue for submittal to workflows. You can create multiple Views per queue.

In contrast, you use the **Queue Interaction block** to place interactions in queues, not to define queues.

- The **Publishing** operation pushes the interaction queue into the Configuration Database. Its definition is stored as a CfgScript object of type Interaction Queue. After defining or selecting an interaction queue, you can direct incoming (outside) interactions into the queue using the Media Server block and end points.

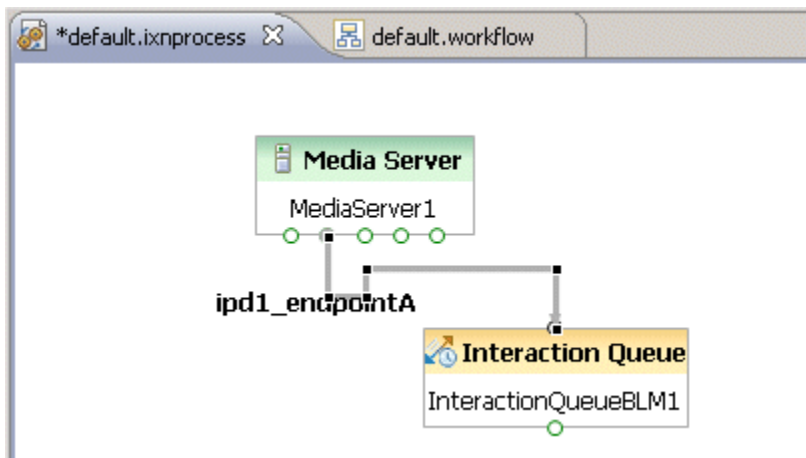

- Queues that you defined with the Interaction Queue block appear for selection in the Queue Interaction block.
- Composer shows one output port per defined View (Views property below). This allows the user to route interactions coming through this View to a specific workflow.
- For all properties below, no updates to Configuration Server are created until you invoke the **Publish** operation.
- You cannot reuse an existing interaction queue in the same IPD, but you can use the same interaction queue in different IPDs. For more information, see **Linking IPDs with Workflows**.
- Composer points Interaction Queue objects directly to EnhancedRoutingScript (ERS) objects. It does not point Interaction QueueView objects to EnhancedRoutingScript objects.

- If routing blocks refer to previously unpublished queues, these references may become incorrect when the queue is published. These errors are caught by workflow validations and should be fixed by selecting the published queue in any block properties that show this validation error.

The Interaction Queue block has the following properties:

Name Property

Find this property's details under [Common Properties](#).

Block Notes Property

Click under Value to display the  button. Enter text to describe the block.

Object Name

A unique Configuration Server Object Name will be created once a [Publish](#) operation is executed. No updates to the database are created until you invoke the Publish operation. If no name is specified for the interaction queue, it will default to the currently implemented naming convention of <project name>.<diagram name>.<block name>. Note: If you rename the block after its corresponding CfgScript object is created in Configuration Server, the original published object name in Configuration Server remains unchanged. For more information, see [Publishing Updates](#).

Enabled Property

This property controls whether or not a block contributes code to the application. You may wish to use this property if there is a need to temporarily remove a block during debugging or, for other reasons during development, temporarily disable a block. This saves the effort of having to remove the block and then add it back later.

Existing Queue Property

Use this property to select an existing interaction queue. Any changes made to the queue in the IPD are updated in Configuration Server during the [Publish](#) operation.

Queue Description Property

Enter a description of the interaction queue. This property will map to the Description key in the annex section Queue of the CfgScript object for the interaction queue.

Views Property

Use the **Views** property to open a dialog box where you can define parameters for Interaction Server to use when processing multimedia interactions waiting in queues. The Composer GUI creates one output per View. It is mandatory to define at least one View for an interaction queue in an IPD. These parameters work with the **Workflow block** Maximum Interactions property and Interaction Server's own option settings as described in the **eServices 8.1 Reference Manual**. See the Interaction Server options section in **Interacting with eServices** in the *Orchestration Server 8.1.4 Deployment Guide*.

In Configuration Server, each View will be created as a separate CfgScript object of type InteractionQueueView.

ORS Extensions Property

Starting with 8.1.4, Composer blocks used to build routing applications (with the exception of the Disconnect and EndParallel blocks) add a new **ORS Extensions** property.

Submitter Objects

In the Composer GUI, the connection between interaction queue View and a workflow (strategy) is represented by interaction Submitter Script object. When you add an interaction queue to a IPD, define a View, point the Workflow block to a .workflow file, and **publish**, this creates a Submitter Script object in the Configuration Database. This is applicable when using the eServices/Orchestration Server feature **enhanced pulling** of interactions from queues and **Use Interaction Submitters** is set to true within Composer.



Use Interaction Submitters

Selecting Properties from the Project menu opens a dialog box showing the properties of the selected Project or of the Project that contains the selected resource. Select Orchestration Server Options to set **Use Interaction Submitters**. For older Projects upgraded to 8.1.4, Use Interaction Submitters is off by default. This option is enabled by default for new 8.1.4 Projects.

You must manually enable this option in the Project Properties to continue with the new way of **publishing**.

Defining a View

To define a view:

1. Click under Value to display the  button.
2. Click the  button to open the View Properties dialog box (see the [Interaction Queue Views](#) topic).
3. Click **Add** to display Main, Parameterized Conditions, and Segmentation tabs.
4. After you complete the applicable fields in these tabs, click **OK** to close the View Properties dialog box.

Note: Multiple views are supported on a single queue. This enables certain interactions to be processed earlier than others.

Interaction Queue Definition

To clarify the term, interaction queue, interaction queues used for multimedia (non-voice interactions) are compared with virtual queues used for voice interactions. Genesys software maintains both **interaction** and **virtual queues**.

- A queue in an [interaction process diagram](#) is called an *interaction queue*. You use Composer's Interaction Queue block to create/configure an interaction queue, which can also be thought of as a persistent queue. Once an interaction queue is configured and activated, multimedia interactions arriving from media servers are selected and extracted using the View block property. They are then submitted to Workflows that send them to another interaction queue or a target (such as an agent, workbin, or server). The definition of an interaction queue defined is stored as a Script object in the Configuration Database.
- In contrast, all voice interactions arriving from T-Servers are submitted to Universal Routing Server (URS), which places them in virtual queues. A virtual queue is not a physical queue but rather a logical queue to which all voice interactions are queued if the specified targets within a routing workflow are not available.

Deleting Interaction Queues

If you delete an Interaction Queue block from an IPD, Composer does not allow deletion of the Interaction Queue block itself. In this case, you must manually clean up the objects using Genesys Administrator.

Adding an Interaction Queue

Starting with Release 8.1.410.14, you can use a queue defined in referenced Projects:

In the Project (A) containing the queue you want to use in another Project (b):

1. Add an **Interaction Queue** block to the interaction process diagram (IPD).
2. Publish the IPD so that the Interaction Queue gets published to the Configuration Server.
3. In the Project (b) where you want to use the interaction queue contained in Project A, open **Project Properties > Project References** and add a reference to Project A.
4. Edit the Queue property for a workflow block. You can now select queues defined in the Project A IPD as well as Project B IPD.

This feature is available via the following blocks/properties:

- Email Forward/ Output Queue
- Create SMS/Interaction Queue
- Email Response/Output Queue
- Route Interaction/ Queue For Existing Interaction
- Route Interaction/Queue for Outgoing Interaction
- Queue Interaction/ Interaction Queue Name
- Create email/ Output Queue
- Chat Transcript/Output Queue

Interaction Queue Views

This topic applies to the Views property for the [Interaction Queue Block](#) and [Workbin Block](#) topics. Views contain parameters used when pulling interactions from queues and workbins for submittal to all workflows for further processing.

Notes:



- Starting with 8.1.4, Composer-created SCXML-based routing applications are assigned to Views instead of being assigned to interaction queues (as in previous releases) and use a Submitter object for this purpose. This change enables enhanced [pulling of multimedia interactions from interaction queues](#).
- This block is used only for multimedia workflows.

Multiple Views Per Queue

You can create multiple views per queue, with each view managing submission of an interaction to a separate routing workflow. Composer creates a dedicated output port on the Interaction Queue block for each view defined in the block. You can connect multiple [workflows](#) to the same view. Flow Control blocks are available.

Defining Views

You are required to create at least one view. To define a view: From the Views property in the Interaction Queue or Workbin block:

1. Click under **Value** to display the  button.
2. Click the  button to open the **View Properties** dialog box.

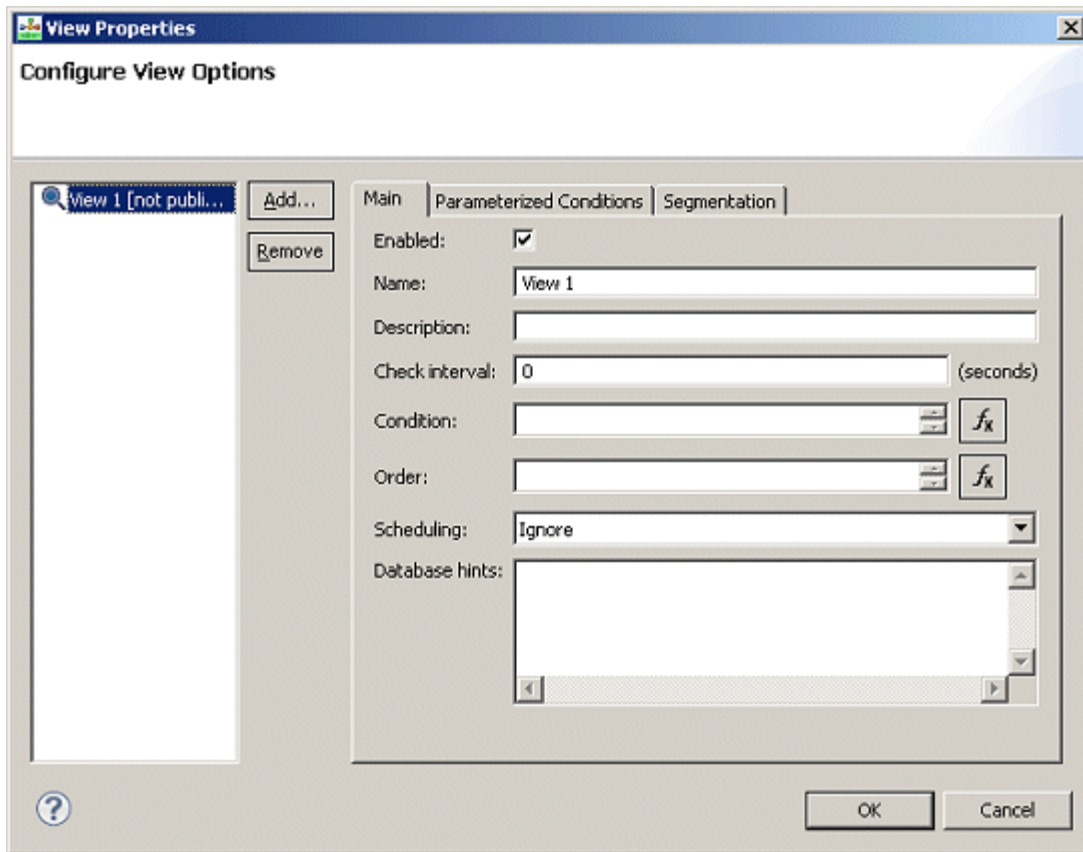

3. Click **Add** to display fields in the Main tab.
4. Complete the fields as described below.

Main Tab

Fields in the Main tab are described table below.

Field	Description
Enabled	Check the box to make the view ready to extract interactions.
Name	Enter a name for the view to be used when saving as Configuration Database Script object.
Description	Enter text describing the view.
Check Interval	Enter the number of seconds to specify the frequency (time interval) that Interaction Server will use to check the queue and, if necessary, adjust the number of interactions that can be submitted to the workflow based on the Scheduling field.
Condition	You have the option of creating an expression to be

	<p>used as the basis for extract interactions from the queue. Examples:</p> <pre>customer_segment='gold' AND service_type='sales' _time_in_queue[] > 4320</pre> <p>You can specify one or more expressions, which can be comprised of:</p> <ul style="list-style-type: none"> • An interaction attribute name from the interactions table. The <i>eServices/Multimedia User's Guide</i> lists and describes the interaction attributes that you can use when building an expression. • A relational operator, such as an equal sign or a greater than sign. • The attribute value in single quotes. • The expression is used for interaction selection as if you were constructing a SQL SELECT statement and specifying a WHERE clause.
Order	<p>You have the option of defining the order for extracting interactions from the queue:</p> <pre>order:= [property_order[,order]]property_order:= property_name [asc desc]</pre> <p>Example using an attribute found in the eService/Multimedia interactions table: priority DESC</p>
Scheduling	<p>Use to specify the scheduling condition that Interaction Server should use, based upon the scheduled time contained in interactions. The interaction scheduling functionality uses a database field called <code>scheduled_at</code>, which is mapped to an interaction property called <code>ScheduledAt</code>. For information on this field, see the chapter on interaction properties in the <i>eService/Multimedia User's Guide</i>.</p> <p>Select one of the following:</p> <ul style="list-style-type: none"> • Ignore Scheduling. Default. Select if there is no scheduled processing. Even if the value of <code>ScheduledAt</code> is set for some interactions, Interaction Server ignores it. • Scheduled Only. Select to process only interactions that are scheduled (<code>ScheduledAt</code> is set) as per the value of the scheduled time. If selected, Interaction Server uses the following condition: <code>(_current_time() >= scheduled_at)</code> and the following order: <code>scheduled_at, received_at, id</code>. <p>This condition and the conditions below are stored in the Scripts folder of Configuration Manager, <code>InteractionQueueView</code> object, Annex tab.</p> <ul style="list-style-type: none"> • Scheduled and Unscheduled. Select to process scheduled interactions at scheduled times

	<p>(ScheduledAt is set) and after that, process unscheduled interactions. In this case, scheduled interactions are delayed until the scheduled time, and all others are processed immediately afterwards. If selected, Interaction Server uses the following condition: ((scheduled_at is NULL) OR (_current_time() >= scheduled_at)) and the following order: scheduled_at, received_at, id.</p> <ul style="list-style-type: none"> • Unscheduled Only. Select to process only interactions that are unscheduled (ScheduledAt is not set). Interaction Server uses the following condition: (scheduled_at is NULL)
Database Hints	<p>This field is only applicable to an Oracle database.</p> <p>Background: Oracle allows special tags in SQL queries that cause queries to execute in a way that optimizes performance. These tags are called Hints. For example, you may wish Oracle to use a certain index to reorder data during query execution. You can apply a Hint, which will cause Oracle to use a specific index. One Hint that Oracle provides is: /*+ index (interactions interactions_default_view_idx) */. You could enter this Hint in the Database Hints field.</p>

Parameterized Conditions Tab

Use the **Parameterized Conditions** tab to specify interaction attributes that can be used in pull requests from clients of Interaction Server (for example, from an agent desktop). Each pull request can use any listed attribute, a combination of listed attributes, or none. If an attribute is not listed on this tab, then client applications cannot use it. For details on pull requests, see the RequestPull section in the chapter on Interaction Management Protocol in the *eService/Multimedia Open Media Interaction Models Reference Manual*. For example, if the Parameterized Conditions tab lists the from_address attribute, then a pull request from a client can include a condition such as from_address=joe_customer@myisp.com. This would retrieve all interactions from a particular contact. The Condition tab and the Parameterized Conditions tab both make use of interaction attributes (see the chapter on Interaction Properties in the *eService/Multimedia User's Guide*. The difference between them is:

- The Condition tab states a condition that applies to all pull requests.
- The Parameterized Conditions tab only lists attributes that can be used as parameters in a pull request, but it is up to the client whether or not to use these attributes.

You can: Select the attribute from a drop-down list of interaction attributes. This list includes most of the attributes in the interactions table. The exceptions are abandoned_at, destinations, moved_to_queue_at, scheduled_at, server_id, and snapshot_place_id. You can also enter the name of a custom property that you have created in Configuration Manager. Creating custom properties is described in the Interaction Properties section of the chapter on Interaction Properties in the *eService/Multimedia User's Guide*.

Using the Parameterized Conditions Tab

1. Click the **Parameterized Conditions** tab in the View Properties dialog box.
2. Click **Add**. The **Property Configuration** dialog box opens.

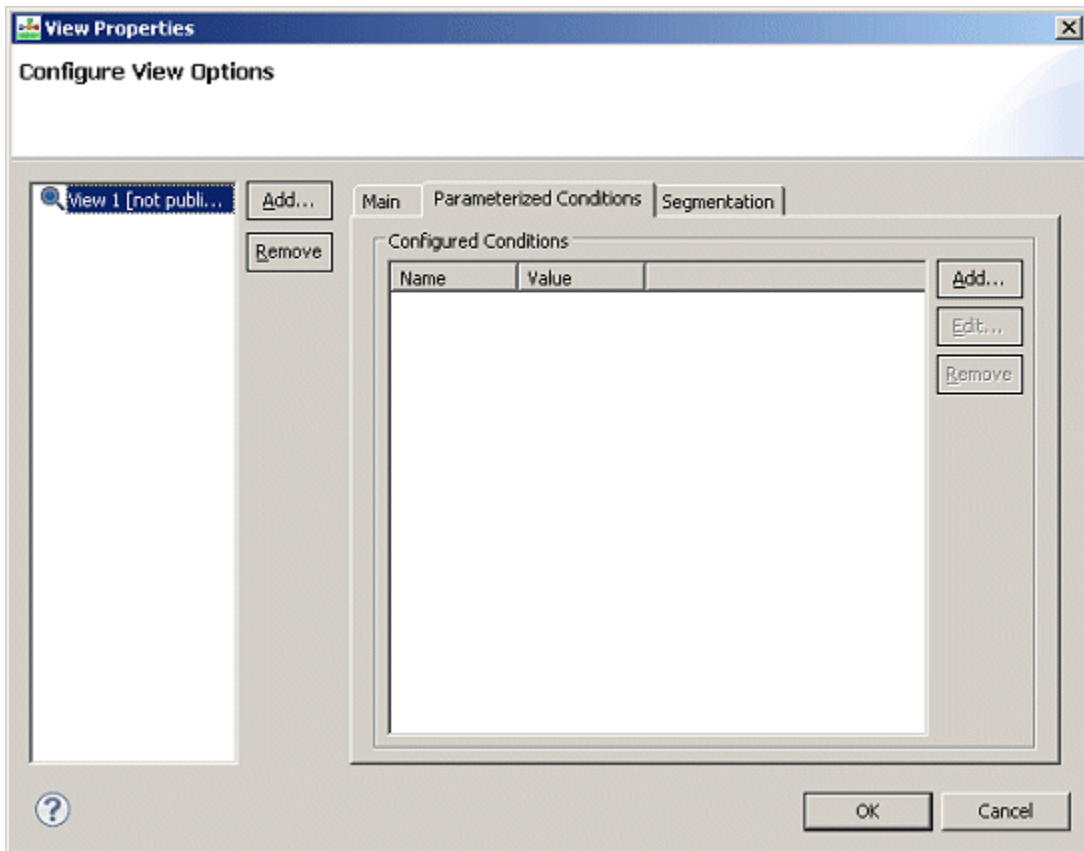

3. Under Name, enter an Interactions table attribute.
4. Under Value, enter a value.
5. Click **OK**. The **View Properties** dialog box shows your entry.

Segmentation Tab

Use the **Segmentation** tab on the View Properties dialog box to submit an equal number of interactions of different segments, to define a default limit for each segment pulled from a queue, and to limit the total number of interactions that can be submitted to a workflow.

Use Case

Assume the following:

- You have a simple business process: a queue, the queue's view, a strategy, and a submitter that submits interactions from the queue to the strategy through the view.
- There are two groups of agents equal in number. One group is trained to handle only customers of the gold Customer Segment and another group is trained to handle only customers of the bronze Customer Segment.
- The strategy directs interactions to the corresponding group of agents based on the value of the `customer_segment` property of an interaction (assume the value could be either gold or bronze).
- Next, start placing interactions into the queue, five interactions from bronze customers, then four interaction from gold customers, then again five interactions from bronze customers, three from gold, and so on.

If the strategy has a limit of five interactions that may be submitted into it, when the limit is reached, the strategy will be full of interactions from bronze customers, but will have no interactions from gold customers. As a result, interactions from gold customers will be waiting back in the queue and free agents, who are able to handle them, will also be waiting. Because the interactions are not yet in the strategy, the strategy is unable to route the interactions. To avoid such a scenario, you could add the `customer_segment` value to the Segmentation tab of the View Properties dialog box. After that, Interaction Server will fetch all interactions from the queue, grouping by the `customer_segment` property. It will find two distinct values of the property: gold and bronze. Interaction Server will then divide strategy limit by two (the number of distinct values) and limit the submission of each group of interactions to the strategy by the calculated value. As a result, Interaction Server submits an equal number of interactions from each group.

Using the Segmentation Tab

1. Click the **Segmentation** tab in the View Properties dialog box.

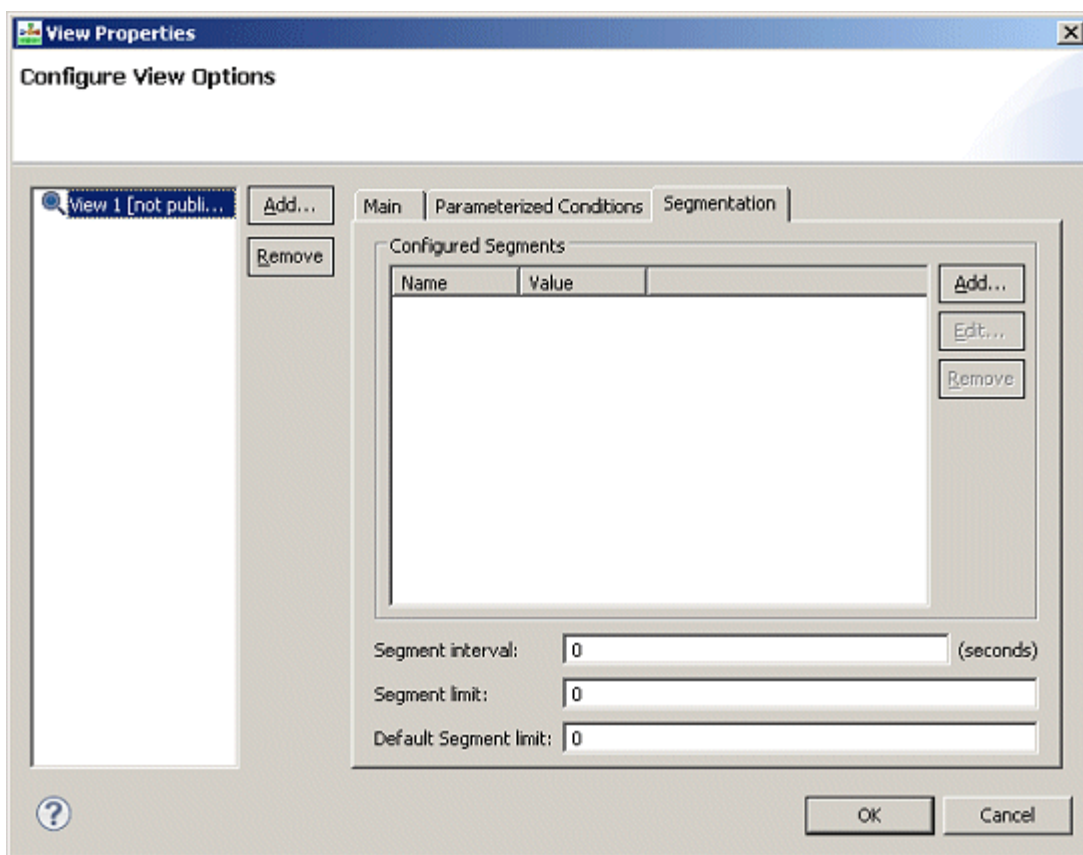

2. Click **Add**. The Property Configuration dialog box opens.
3. Opposite **Name**, enter an Interactions table attribute.
4. Opposite **Value**, enter a value.
5. Enter a **Segment Interval**. Specifies the time, in seconds, that elapses before Interaction Server rechecks the queue and adjusts the number of interactions that can be submitted to the strategy according to segmentation options. If you do not specify a value, Interaction Server uses the default value (set in the General tab). Use this parameter when the default interval at which a queue is checked for new interactions is too long, causing highly time-sensitive interactions to remain in the queue too long.
6. Enter a **Segment Limit**. Enables you to override the maximum number of interactions that can be submitted to a strategy according to the configured segmentation options. If you do not enter a value, Interaction Server uses the limits set in the strategy. Starting with 81410, the IPD View publish logic does not generate default-limit option in the View section if the value is 0. The default-limit option is generated only if the value is greater than zero. For existing Diagrams, republishing the IPD diagram removes the default-limit option if the value is zero and updates the value if it is greater than zero.
7. Enter a **Default Segment Limit**. Enables you to control the segmentation feature by specifying default number of interactions per segment. The segmentation feature ensures that equal number of interactions that belong to different segments are submitted into the URS strategy. By default, Interaction Server calculates that number by dividing the total limit for number of interactions in the strategy by the actual number of unique segments present. This Default Per Segment option overrides this behavior and uses this option value instead of calculating the limit dynamically. This feature is useful when the number of segments is large (> 1000) and changes rapidly in a wide range. In this

case, it might take too long for the segmentation algorithm to balance the number of interactions submitted to URS. The Default-Segment Limit is generated only if the value is greater than zero. For existing diagrams, republishing the IPD remove the Default Segment Limit if the value is zero; updates the value if it is greater than zero.

8. Click **OK**. The View Properties dialog box shows your entry.

Media Server Block

This block is used only for multimedia workflows. Use the Media Server block to get interactions of a particular media type (other than voice) into an interaction process diagram.

Endpoints

A Media Server is associated with one or more Endpoints, with each Endpoint connecting the Media Server to an interaction queue. For a Media Server block to show Endpoints, those Endpoints must first exist in the Configuration Database. Then, after you select the Media Server via the Composer Application Property, the Endpoint ports appear on the Media Server block as well as being listed opposite the Composer Endpoints property. The figure below illustrates this.

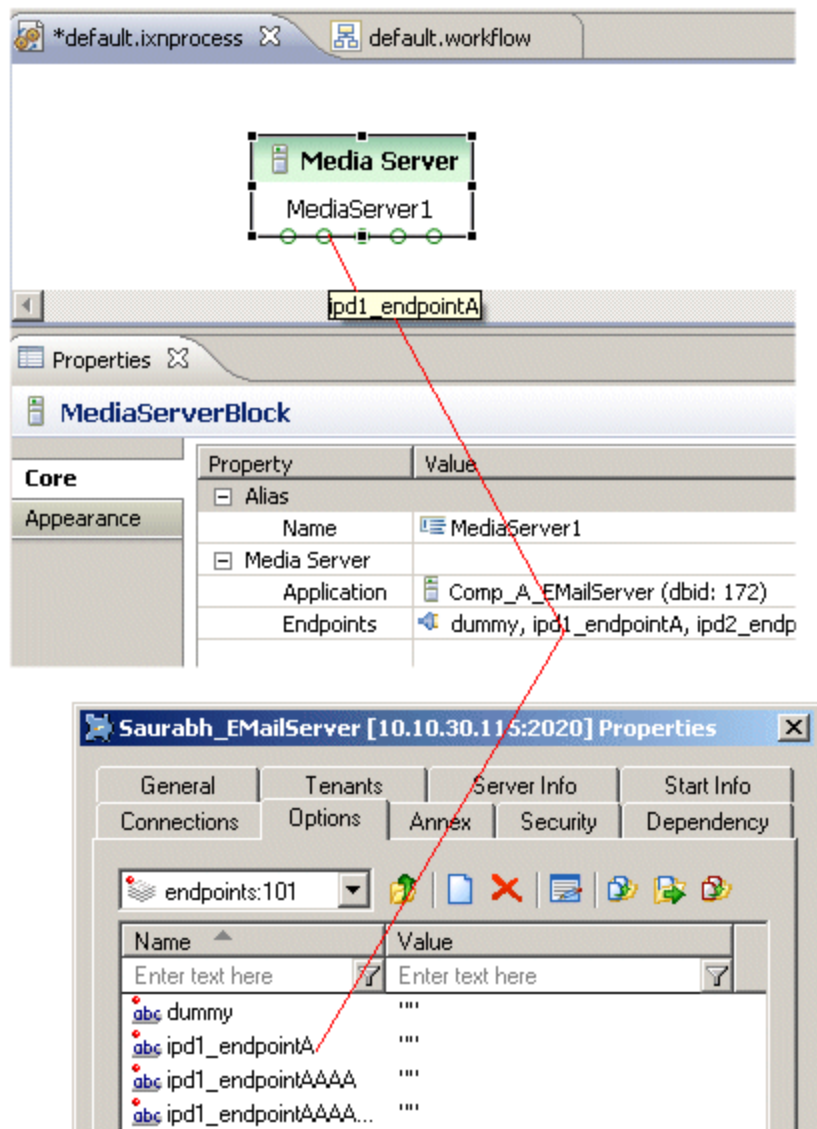

Endpoints1.gif

The **Publishing** operation causes Composer to push the information into the Configuration Database. Its definition is stored as a CfgScript object. The Media Server block will usually be the first block in a multimedia IPD followed by an **Interaction Queue block**, and then a **Workflow block**. The process goes like this: You connect a Media Server Endpoint to an Interaction Queue block and the Interaction Queue block to a Workflow block. This arrangement directs multimedia interactions from the media server into a queue. A **view** defined for the queue then pulls interactions from the queue and sends them to a workflow for specialized processing. **Notes**

- A Media Server block has one or more outputs; no input ports are available.
- Multiple Media Server blocks in an IPD cannot refer to the same media server application.

Media Servers Supported

Composer supports using the following Genesys eService/Multimedia media servers in IPDs:

- E-mail Server Java--interfaces with the enterprise mail server and the Genesys Web API Server, bringing in new e-mail interactions from customers and sending out replies or other outbound messages.
- SMS Server--used for the common text messaging service available on cellphones and other handheld devices.
- Chat Server--works with Web API Server to open, conduct, and close chat.
- Third Party Server, such as Capture Point applications. Capture Point applications are defined in two possible ways:
 1. An application with type `CFGCapturePoint`.
 2. An application with type `CFGThirdPartyServer`, containing a configuration option called `capture-point-type` in the settings section.

For more information on the above server types, see the *eServices 8.1 Deployment Guide*. The Media Server block has the following properties:

Name Property

Find this property's details under [Common Properties](#).

Application Property

Select a media server to specify the `CfgApplication` object in Configuration Server that this block represents. Any media server already referenced by other Media Server blocks in the same IPD will not be listed. Once the media server Application object is selected, each Endpoint defined in its `CfgApplication` object will be shown as an outport on the block. **Notes:**

- Different Media Server blocks in the same IPD cannot refer to the same Media Server Application instance in Configuration Server.
- The same Media Server instance in Configuration Server may be referenced by multiple IPDs.
- One IPD can have multiple Media Server blocks.

Endpoints Property

Click under Value to display the Media Server Endpoints dialog box and select one or more Endpoints. An Endpoint connects a media server to a queue (Interaction Queue block) within an IPD. The dialog box lists all the Endpoints associated with the media server specified in the Media Server Application property. When you connect an Endpoint to an Interaction Queue block in the IPD diagram, this will

cause interactions coming out of this Endpoint to go into the named interaction queue. **Notes:**

- For endpoints already existing on the selected Media Server, only those that were previously unused are displayed as outports on the block. All endpoints are displayed in the Endpoints dialog, with information about which diagram is using each endpoint.
- You may define Media Server Endpoints in offline mode. The changes will take effect immediately in the local IPD diagram. However, other IPD diagrams that use this Media Server will not see the changes as that will require that Configuration Server be updated with Endpoint details.
- In offline mode, you may input multiple Endpoints and have those definitions stored. Updates to Configuration Server occur when Composer is connected to Configuration Server and you invoke the **Publish** action.
- If an Endpoint of a Media Server is already assigned in Configuration Server, then the Endpoint for the Media Server block is not available for connection to an Interaction Queue block.
- If a Media Server block is deleted, its definition will be removed from the IPD. However, the Media Server object in Configuration Server will not be modified. Any Endpoints created in the current Media Server block will remain and may be deleted using Genesys Administrator. You can, however, delete the Endpoints first and then delete the block.

ORS Extensions Property

Starting with 8.1.4, Composer blocks used to build routing applications (with the exception of the Disconnect and EndParallel blocks) add a new **ORS Extensions** property.

Workflow Block

This block can be used for voice workflows, multimedia workflows, or [interaction-less processing](#) when the block is not connected to an Interaction Queue block. Use this block in an [interaction process diagram](#) to point to a workflow resource (workflow diagram or SCXML file) to which interactions should be sent for processing. Outgoing connections automatically appearing from a Workflow block that represent objects specified inside the workflow are referred to in this help as "[workflow-generated blocks](#)."

Important

When a workflow is part of an interaction process diagram used for multimedia interactions, always finish the workflow (and each workflow branch) with one of these blocks: [Stop Interaction](#), [Queue Interaction](#), or [Route Interaction](#).

The Workflow block has the following properties:

Name Property

Find this property's details under [Common Properties](#).

Block Notes Property

Click under Value to display the  button. Enter text to describe the block.

Object Name Property

A unique Configuration Server object name will be created once a Publish operation is executed. No updates to the database are created until you invoke the Publish operation. Note: If you rename the block after its corresponding CfgScript object is created in Configuration Server, the original published object name in Configuration Server remains unchanged. For more information, see [Publishing Updates](#).

Workflow Blocks and Publishing an IPD

When publishing an interaction process diagram (IPD) to Configuration Server, Workflow blocks are handled in two different ways:

Use Case #1: The Workflow block is dedicated to voice or interaction-less processing. In that case,

you must use a stand-alone block (the block is not connected to any other block).



- When generating the code: Composer generates one SCXML file per such Workflow block (Name=IPD_<ipd file name>_<workflow block name>.scxml).
- When publishing: Composer creates one Enhanced Routing Script object (Name=<Project Name>.<IPD name>.<Workflow block name>) per such Workflow block in the IPD being published. The Application/url property of the ERS refers to the SCXML url (if deployed). The Workflow block Object Name property (read only property) is updated to the name of the EnhancedRoutingScript object.

Use Case #2: The Workflow block is dedicated to multimedia processing. In this case, the block is connected (directly or indirectly) after a Workbin block or an Interaction Queue block.

- When generating the code: Composer generates one SCXML file per Interaction Queue/Workbin block (Name=IPD_<ipd file name>_<interaction queue block name>.scxml). If an IPD has an Interaction Queue block connected to multiple Workflow blocks (multiple views are defined on the Interaction Queue block), only one SCXML file is generated when generating the code for that IPD. This unique IPD SCXML is used to initiate the execution for all Workflow blocks. At runtime, the Workflow SCXML to execute is selected depending on the view the interaction is pulled from.
- When publishing: Composer creates one Interaction Queue Script object (Name=<Project Name>.<IPD name>.<Interaction Queue block name>) per Interaction Queue block. Composer creates one Interaction Queue **InteractionQueueViews** Script object (Name=<Project Name>.<IPD name>.<Interaction Queue block name>.<View name>) per Interaction Queue block defined view. Composer creates one EnhancedRoutingScript object (Name=<Project Name>.<IPD name>.<Interaction Queue block name>.Routing) per Interaction Queue block in the IPD being published. The Application/url property of this EnhancedRoutingScript object refers to the Queue IPD SCXML url (if deployed). Composer does NOT create an EnhancedRoutingScript object for the workflow blocks. The Workflow block Object Name property (read only property) is NOT updated.

Resource Property

To define a resource:

1. Click under **Value** to display the  button.
2. Click the  button to open the Select Resource dialog box.
3. Select a workflow resource, which can be:
 - A workflow diagram that exists in any of the Projects in the Composer workspace.
 - An SCXML file created in Composer's **SCXML Editor**.
4. Select the workflow resource.
5. Click **OK**. An example is shown below.

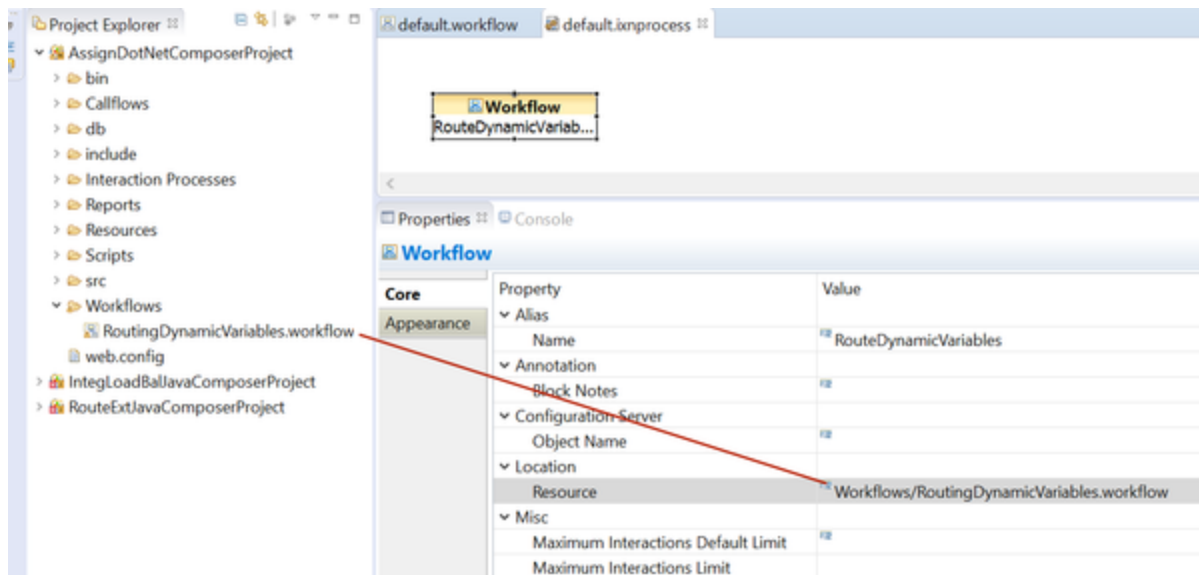

Maximum Interactions Default Limit

(Maximum Interactions in Composer versions previous to 8.1.440.18.) Use this property to specify the maximum number of interactions allowed for a strategy to process at any given time. Possible valid values are 1 - 50,000 and If not specified, Interaction Server uses the default limits configured in its options as described by the max-submitted-interactions option, which includes the URS and InteractionServer object name. For more information on this option, see the eServices [Reference Manual](#).

Important

This block property is only relevant for interactions queued on Interaction Server and takes precedence over any settings configured in Interaction Server and on the Annex tab of the Interaction Queue.

During an **IPD publish**, the EnhancedRoutingScript object in Configuration Server will have this configured value published under the "Default" section.

Maximum Interactions Limit

This property allows you to enter multiple sets of URS and Interaction Server names with limits. The same combination of URS Server name and Interaction Server name is allowed only once. During an IPD Publish operation, the EnhancedRoutingScript object in the Configuration Database will have these values published under the \$URSServerName\$ section. Possible valid values are any integer between 1-50,000.

Shortcut Menu

Right-clicking a Workflow block opens a menu with the following options:

- **Add Note**
- **File**
- **Edit**
- **Delete From Model**
- **Format**
- **Open Workflow**
- **Show Properties View**

Selecting **Open Workflow** opens the workflow resource file in Composer.

- If the resource is a workflow, the diagram will be opened in the workflow diagram editor.
- If the resource is a SCXML file, it will be opened in the SCXML editor in Composer.

Workbin Block

This block is used only for multimedia workflows. Use this block in an [interaction process diagram](#) to define a temporary storage area called a workbin, which is accessible from the agent desktop. You can then use the [Workbin property](#) in the Route Interaction block when redirecting interactions for continued processing. Internally, a workbin has a queue and can support [views](#). The workbin owner (agent, agent group, place, or place group) can view contents of the workbin and pull interactions out in any order. An agent associated with a workbin may get a notification when interactions are put into the workbin.

Input and Output Ports

A Workbin block:

- Does not have any input ports. You add Interactions to a workbin via the Route Interaction block in a workflow diagram.
- Has only one output, which can be connected to a Workflow block in the IPD. Floating workbins are also allowed that are not required to be connected to Workflow blocks. This allows interactions routed to workbins to remain in workbins until they are pulled out by agents

The Interaction Workbin block has the following properties:

Name Property

Use this property to define the name of the workbin, which will appear on the block in the IPD (this is not the Configuration Database name). Find this property's details under [Common Properties](#).

Block Notes Property



Click under Value to display the  button. Enter text to describe the block.

Object Name Property

A unique Configuration Server Object Name will be created once a [Publish](#) operation is executed. No updates to the database are created until you invoke the Publish operation. Note: If you rename the block after its corresponding CfgScript object is created in Configuration Server, the original published object name in Configuration Server remains unchanged. For more information, see [Publishing Updates](#).



Interaction Queue Property

Specifies the queue to be used with this workbin. This may be an existing queue in the IPD or it can be a private queue exclusive to this workbin. Multiple workbins can use the same queue.

1. Click under Value to display the  button.
2. Click the  button to open the Workbin Interaction Queue dialog box.
3. Select one of the following:
 - Use **Private Queue** for a queue exclusive to this workbin.
 - Use **Queue** to select an interaction queue already defined in this IPD.
4. Click OK.

Views Property

A workbin can have one or more views defined in it. Each view represents an exit channel from the workbin (or workbin's queue). The criteria defined in the view must be satisfied before an interaction can exit out from the view. You can also use a view to enable certain types of interactions to be processed earlier than others. Note: Irrespective of the number of views defined in the Workbin block, the block will have only one output and will feed interactions to only one workflow. To define a view:

1. Click under Value to display the  button.
2. Click the  button to open the View Properties dialog box.
3. Click Add to display Main, Parameterized Conditions, and Segmentation tabs. For information on these tabs, see [Interaction Queue Views](#).
4. After you complete the applicable fields in these tabs, click OK to close the View Properties dialog box. Each view will be created as a separate CfgScript object of type Interaction Queue View.

Description Property

Enter text that describes the workbin.

Display Name Property

Enter a display name for the workbin to appear in the interaction process diagram.

Enabled Property

Select **true** or **false** to enable or disable this queue as ready to accept interactions. A queue may be enabled during design time. Note: Setting this property is equivalent to enabling or disabling the Workbin object from Genesys Administrator or Configuration Manager.

Order Property

Use this property to specify the WHERE clause of a SQL statement, which will determine the order in which interactions will be sorted in the workbin.

Owner Property

A workbin may be owned by (associated with) one or more agents. Click the down arrow and select one of the following:

- **Agent**
- **Agent Group**(default)
- **Place**
- **Place Group**

Agents associated with a workbin may get a notification if an item is placed in the workbin.

Enabled Property

This property controls whether or not a block contributes code to the application. You may wish to use this property if there is a need to temporarily remove a block during debugging or, for other reasons during development, temporarily disable a block. This saves the effort of having to remove the block and then add it back later.

ORS Extensions Property

Starting with 8.1.4, Composer blocks used to build routing applications (with the exception of the Disconnect and EndParallel blocks) add a new **ORS Extensions** property.

Deleting Workbins

If you delete a Workbin block from an IPD in online mode, Composer displays a prompt asking if you wish to delete its Configuration objects. These will include:

- Interaction Workbin (CfgScript:: InteractionWorkBin)
- Interaction Queues (CfgScript::InteractionQueue)
- Interaction Queue Views (CfgScript:: InteractionQueueView)

If you indicate Yes," then the Interaction Queue object and view objects will be deleted from Configuration Server. If you indicate No," Composer will not delete these objects from Configuration Server. You must manually clean up these objects outside of Composer. In offline mode, if you delete a Workbin block from an IPD, the Configuration Server connection dialog is shown. If a connection cannot be established, object deletion will fail and you must manually delete the objects outside of Composer.

Flow Control Blocks

In an IPD, when an interaction is submitted from an **interaction queue** to a routing **workflow**, you can create multiple views per queue, with each **view** having its own set of conditions and managing submission of an interaction to a separate routing workflow. To support multiple views per interaction queue, the following Flow Control blocks are available when **creating an IPD**:

- **Branching**
- **ECMAScript**
- **Log**

ORS Extensions Property

Starting with 8.1.4, Composer blocks used to build routing applications (with the exception of the Disconnect and EndParallel blocks) add a new **ORS Extensions** property.

Workflow Generated Blocks

Outgoing connections automatically appearing from a **Workflow block** that represent objects specified inside the workflow are called *workflow-generated blocks*. Composer generates the following types of workflow-generated blocks:

- **Forward to External** (Email Forward Block)
- **Autoresponse**
- **Chat Transcript**
- **Classify Interaction**
- **Dynamic Target**
- **Queue Reference**
- **Stop**
- **Workbin Reference**

For example, assume a Workflow block in an IPD references a workflow that contains a **Queue Interaction block** that references an interaction queue, a **Route Interaction block** that specifies a **routing target**, and a **Stop Interaction block**. The workflow-generated Stop, Queue Reference, and Dynamic Target blocks appear as shown in the figure below.

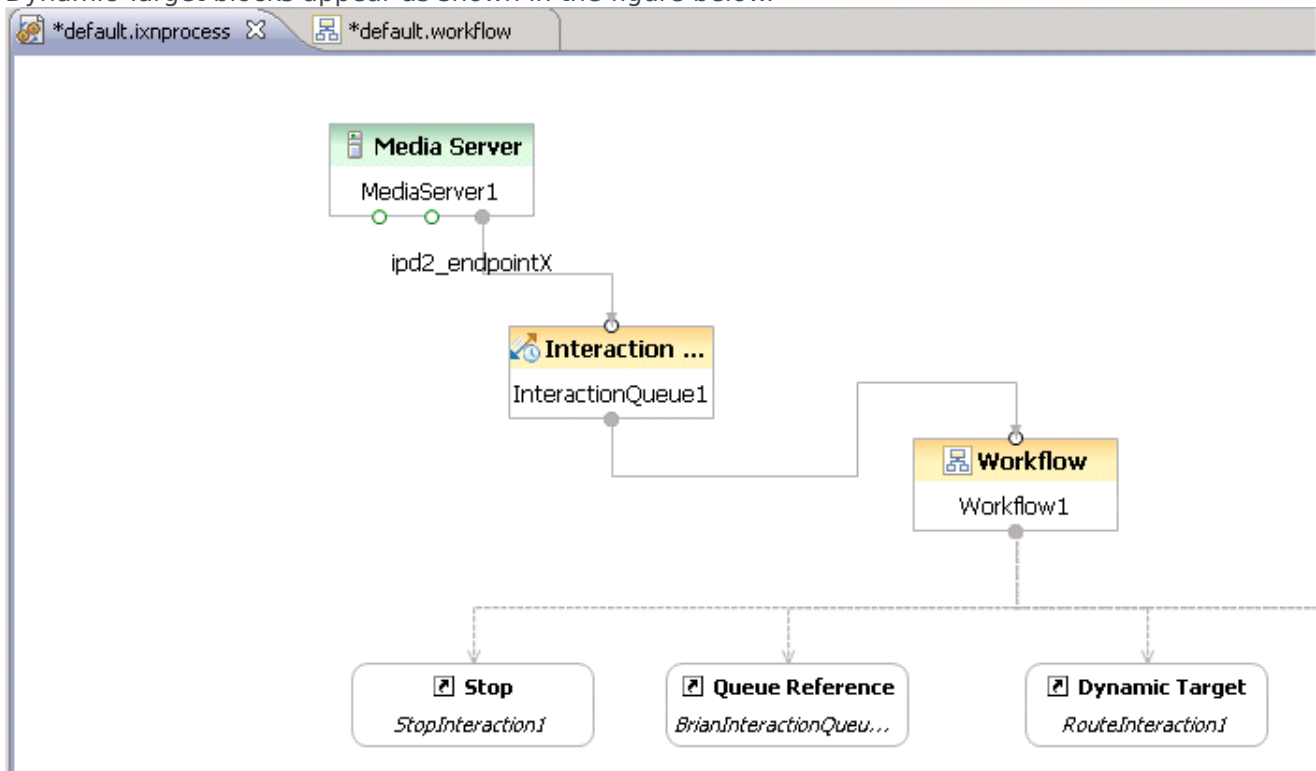

Queue Reference Block

If a workflow referenced in any Workflow blocks puts an interaction into a queue using the Chat Transcript, Email Response, E-mail Forward, or **Queue Interaction** block, the IPD shows this information. It displays an additional block of type Queue Reference to represent the interaction queue and shows an interaction going from the Workflow block to this Queue Reference block. This block is automatically generated by Composer, therefore is not available on the IPD **palette**. Composer uses a different color, appearance, and structure for the Queue Reference block allowing you to easily differentiate it from other blocks selectable from the palette. If a workflow referenced in any Workflow block creates a new interaction, the IPD shows this information using the Queue Reference block. The connector for the new interaction from the Workflow block to the 'Queue Reference' block will be shown with a distinctive line pattern in a different color from normal connectors. UI team will be consulted. If the queue used in the Queue Interaction block was already defined in the IPD, the workflow will connect back to the Interaction Queue block already present in the diagram. **Blocks Linking to Queue Reference Blocks**

- IPDs will show a linked Chat Transcript workflow-generated block if a referenced workflow uses a **Chat Transcript block**. The linked Chat Transcript block will link to a Queue reference block representing the queue used in the relevant block in the workflow.
- IPDs will show a linked E-mail Response workflow-generated block if a referenced workflow uses an **E-mail Response block**. The linked E-mail Response block will link to a Queue reference block representing the queue used in the relevant block in the workflow.
- IPDs will show a linked Forward workflow-generated block if a referenced workflow creates a reply e-mail using the **E-mail Forward block** with Forward to External as the Forward Type property. The linked Forward block will link to a Queue reference block representing the queue used in the relevant block in the workflow.
- IPDs will show a linked Classify Interaction workflow-generated block if a referenced workflow uses a **Classify Interaction block** to classify an interaction.

Dynamic Target Block

If a workflow referenced in any Workflow blocks routes the interaction to a dynamic target via the **Route Interaction block**, the IPD diagram will show this information using an additional block of type "Dynamic Target." This block is not available in the IPD palette since it is automatically generated by Composer. A Dynamic Target block gives a visual indication of the type of target the interaction is being routed to. A note attachment is added to the block giving details of the targets.

Stop Block

If a workflow referenced in any Workflow block stops an interaction using the Stop Interaction block, the IPD shows this information using an additional block of type "Stop." This block is not available in the IPD palette since it is automatically generated by Composer.

Workbin Reference

If a workflow referenced in any Workflow blocks uses the Route Interaction block to put an interaction into a workbin, the IPD diagram shows this information using a workflow-generated blocks of type "Workbin Reference." If a referenced Workbin block uses a non-private queue, a Queue Reference block is shown in the IPD originating from the Workbin Reference block. This is helpful if the Workbin block uses a queue that is defined in another IPD in the same Project. These blocks are not available in the IPD palette since they are automatically generated by Composer. The figure below shows example Queue Reference and Workbin Reference blocks.

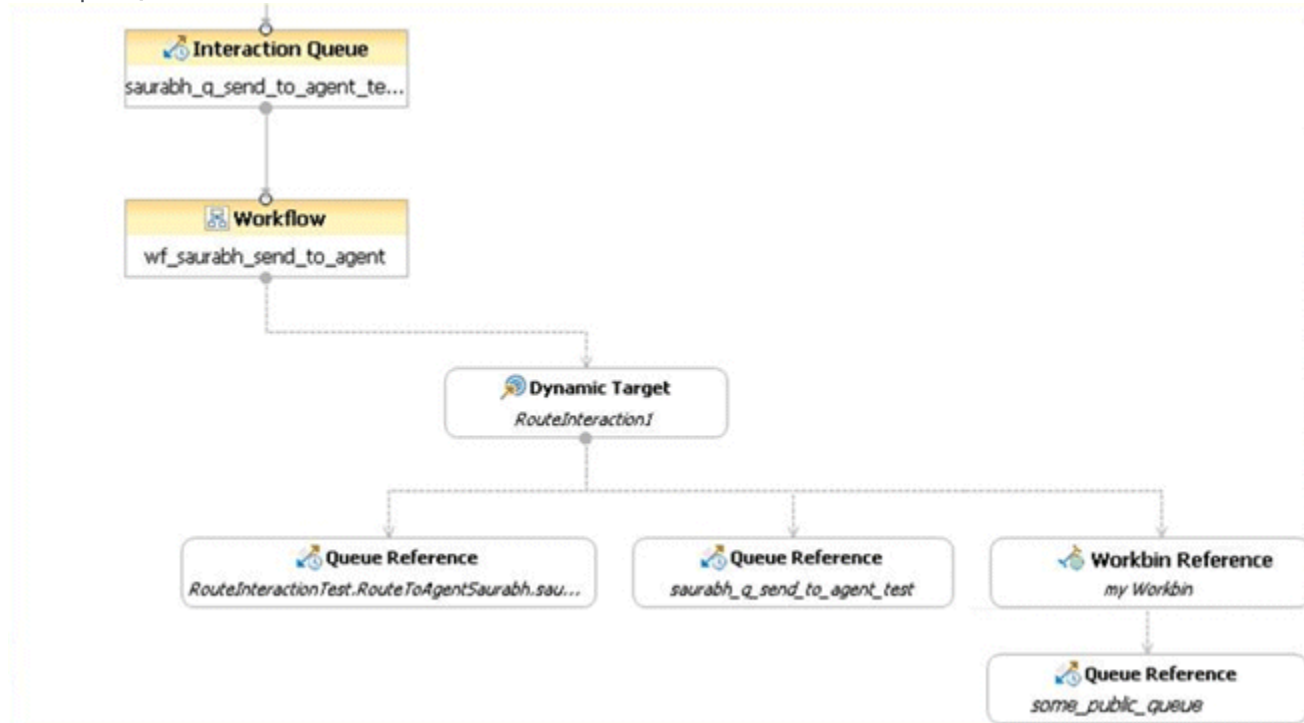

Linking IPDs with Workflows

You can't explicitly link IPDs together as there is no higher-level diagram in Composer that shows IPDs as blocks and then allows you to interconnect them. To clarify:

- IPDs are linked via the workflows they are connected to. For example, assume IPD1 references Workflow1 and this workflow uses an Queue Interaction block. The block can be set to route the interaction to a Queue2 and Queue2 could exist in IPD2. Therefore IPD1 gets connected to IPD2.
- Interaction Queue blocks in IPDs don't reference queues; they are queues.
- An interaction queue can be defined in only one IPD. Once defined and **Published**, a corresponding object is created in Configuration Server. This interaction queue cannot exist in any other IPD. It can, however, be referenced by blocks in any number of workflows in the same Project.

Note: IRD allows moving a queue from one business process to another. Once moved, the queue can be used in the new business process. To do the same in Composer, you can copy an Interaction Queue block from one IPD and paste into another. Then delete the block from the original IPD. The same Interaction Queue block cannot exist in two IPDs.

Publishing Updates

Publishing an **interaction process diagram** validates Project configuration information and pushes the information out to Configuration Server. When you configure an Interaction Queue, Workflow, or Workbin block, Composer does not send the information to Configuration Server until you invoke the Publish operation. This gives you complete control of the update process. When publishing an interaction process diagram, Composer also updates the Configuration Server/Object Name property of the IPD blocks for which a configuration object was created (applies to Workflow, Workbin, Interaction Queue blocks). You can set Configuration Server Preferences to:

- Automatically publish upon saving.
- Display a prompt to save before publishing.
- Delete published objects when an interaction process diagram is deleted.
- Delete published objects when a project is closed or deleted.

For information on resetting IPD Publish information, see the figure under the Reset IPD Publish Information heading in the **Project Properties** topic.

When to Publish

- Any time properties for any of the blocks in the IPD are changed or blocks are added/removed.
- For example, to create a **Submitter** Script object in the Configuration Database.
- Any time a workflow diagram is renamed. In such cases, you must go back to the Workflow block in the IPD diagram and point the block to the renamed workflow.
- If you rename your workflow Project -- this will change the deployment URL for the Project. Publishing again will point the enhanced routing object to the new URL.
- If you delete Published objects in Configuration Server, you can re-publish the diagram to create new objects.

Note: If routing blocks refer to previously unpublished queues, these references may become incorrect when the queue is published. These errors are caught by workflow validations and should be fixed by selecting the published queue in any block properties that show this validation error.

How to Publish

1. Before publishing, you must **connect to Configuration Server**.
2. Right-click an interaction process diagram in the Project Explorer.
3. Select Publish to Configuration Server. The following message appears: The selected IPD diagram's data was successfully published to Configuration Server.

Once these objects are created successfully in Configuration Server, some manual configuration is still required before interactions can work. For example, to redirect e-mails to an Endpoint, you must set endpoint key in the pop-clientX section of the e-mail server Application to the correct end-point. For more details, see [Deploying a Routing Application](#).

Overwriting Published Queues

Starting with Composer 8.1.520.##, Composer supports the ability to overwrite published queues. Users can now choose to override or ignore the existing script objects on Configuration Server when republishing an interaction script. This new functionality is very useful in multiple user environments. Prior to this release, only the first user publishing a script was considered as the owner of the project and other users (even from the same team) were restricted from publishing IPD objects to Configuration Manager.

Consider two users, A and B. A starts initial development, publishes the IPD objects, and shares the project with B. B imports the project and makes some additional improvements to contribute to the project. Prior to this release, when B tries to republish the IPD objects, the following error message is displayed:

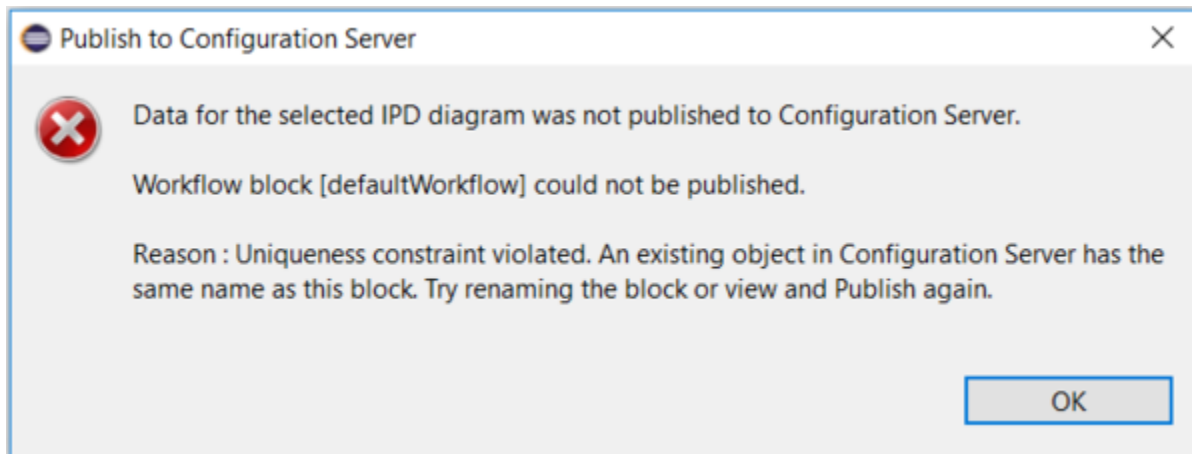

Instead, beginning with this release, a new dialog box is now displayed when a user tries to publish interaction scripts which have already been published to Configuration Manager. The user can then select the items which needs to be re-published.

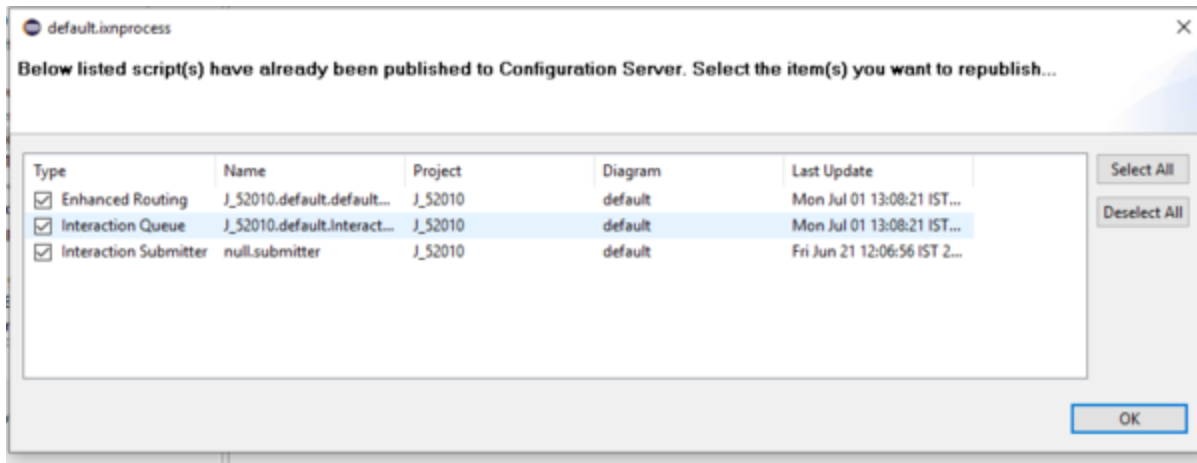

Composer Marker Section

The Publish operation puts a marker section in each Configuration Database object it creates. The section name is `__COMPOSER__`. The section has the following keys:

Key Name	Value	Description
source	composer	Hard-coded value to indicate object was created by Composer
last_updated	<timestamp>	Indicates the timestamp when the publish operation was initiated that modified this object. Example: Thu Jan 07 11:26:36 PST 2010. I
owner_diagram	<string>	Name of the Composer diagram that published this object.
owner_project	<string>	Name of the Composer project that owns the IPD diagram in owner_diagram.
owner_uuid	<string>	Identifier of the Composer diagram that published this object.

IRD Objects Not Modified

The Publish operation does not modify queue and view objects that were not created by Composer. This avoids accidentally modifying objects previously created by Universal Routing's Interaction Routing Designer (IRD), which may cause issues in a legacy IRD/URS system. Using the marker section described above to indicate where the object was created, the following types of objects are not modified if they were not created by Composer:

- CfgScript of type Interaction Queue
- CfgScript of type Interaction Queue View
- CfgScript of type Workflow

Media Server Block Update Detail

The following updates are written to Configuration Server for all **Media Server blocks** in all IPD diagrams in the Project:

- Updates **endpoints**:<tenant DBID> section of specified CfgApplication.
- Each endpoint name attribute's value is set to the name of the interaction queue's CfgScript object that it is connected to. Only endpoints that were owned by this diagram, or were previously unconnected, are updated.

Interaction Queue Block Update Detail

The following updates are written to Configuration Server for all **blocks** in all IPD diagrams in the Project:

- A CfgScript object (type = Interaction Queue) is created under the current tenant/Scripts folder. If the object already exists, its properties are updated.

Block Property	Configuration Server Object/Option
Description	CfgScript object/Annex Section Queue/Description property
Queue Enabled	State property of the CfgScript object. If TRUE, set to CFGEnabled. If FALSE, set to CFGDisabled.

- In the Annex of the CfgScript object, the property application is created in section Orchestration. Composer writes the value in this format: script:<name of Enhanced Routing CfgScript object> where <name of EnhancedRouting CfgScript object> will be replaced with the workflow name.

This will essentially cause all views of the interaction queue to submit interactions to the SCXML application that the Enhanced Routing object points to. In the IPD, this will be a **Workflow block** pointing to an existing workflow diagram or an SCXML file. Note: If you rename an Interaction Queue block after its corresponding CfgScript object has been created, the object name in Configuration Server remains unchanged. Instead, the key Name in the Annex section Namespace and its value are set to the new name. Composer displays the changed name.

Interaction Queue View Property Update Detail

The following updates are written to Configuration Server for all **Views** defined for all Interaction Queue blocks and Workbin blocks in all IPD diagrams in the Project:

- A CfgScript object (type = Interaction Queue View) is created under the current tenant/Scripts folder. If the object already exists, its properties are updated. The name of the object follows this format: <container queue CfgScript object name>/<view name>

Block Property	Config. Server Object Type	Annex/Option Section	Key/Property
View Name	CfgScript	Namespace	Name
Description	CfgScript	View	Description
Enabled	CfgScript	-	State property
Check Interval	CfgScript	View	Freeze Interval
Condition	CfgScript	View	Condition
Order	CfgScript	View	Order
Scheduling	CfgScript	View	scheduling-mode
Parameterized Conditions (multi-valued)	CfgScript	View	Each value creates a key like "Condition.<value>"
Database Hints (Oracle)	CfgScript	View	sql-hint
Segmentation (multi-valued)	CfgScript	View	segment-by Value will be "value1,value2,...valueN"
Segment Check Interval	CfgScript	View	segment-check-interval
Segment Limit	CfgScript	View	segment-total-limit

Note: If you rename a View after its corresponding CfgScript object has been created, the object name in Configuration Server remains unchanged. Instead, the key Name in the Annex section Namespace and its value are set to the new name. Composer displays the changed name.

Workflow Block Update Detail

The following updates are written to Configuration Server for all **Workflow blocks** in the Project.

- A CfgScript object of the Enhanced Routing type is created under the current tenant/Scripts folder.
- In its annex, property url is created in section Application. The value is the URL of the generated SCXML document on the Composer web server (bundled Tomcat or local IIS). You can change this property using Configuration Manager or Genesys Administrator to set the correct value for the deployment environment.

In its annex, in section ApplicationParams, the key CustomerView_URL is added. Its value is in this format: [http:// http://]<configured CV host>:<configured CV port>. Context Services port and host

values are picked up from Composer preferences.

Workflow Blocks and Publishing an IPD

This use cases below apply when **Use Interaction Submitters** is not enabled and you are not using **Interaction Submitters**.

In this case, when publishing an interaction process diagram (IPD) to Configuration Server, Workflow blocks are handled in two different ways:

Use Case #1: The Workflow block is dedicated to voice or interaction-less processing. In that case, you must use a stand-alone block (the block is not connected to any other block).

- When generating the code: Composer generates one SCXML file per such Workflow block (Name=IPD_<ipd file name>_<workflow block name>.scxml).
- When publishing: Composer creates one Enhanced Routing Script object (Name=<Project Name>.<IPD name>.<Workflow block name>) per such Workflow block in the IPD being published. The Application/url property of the ERS refers to the SCXML url (if deployed). The Workflow block Object Name property (read only property) is updated to the name of the Enhanced Routing Script object.

Use Case #2: The Workflow block is dedicated to multimedia processing. In this case, the block is connected (directly or indirectly) after a Workbin block or an Interaction Queue block.

- When generating the code: Composer generates one SCXML file per Interaction Queue/Workbin block (Name=IPD_<ipd file name>_<interaction queue block name>.scxml). If an IPD has an Interaction Queue block connected to multiple Workflow blocks (multiple views are defined on the Interaction Queue block), only one SCXML file is generated when generating the code for that IPD. This unique IPD SCXML is used to initiate the execution for all Workflow blocks. At runtime, the Workflow SCXML to execute is selected depending on the view the interaction is pulled from.
- When publishing: Composer creates one Interaction Queue Script object (Name=<Project Name>.<IPD name>.<Interaction Queue block name>) per Interaction Queue block. Composer creates one Interaction Queue View Script object (Name=<Project Name>.<IPD name>.<Interaction Queue block name>.<View name>) per Interaction Queue block defined view.

Composer creates one Enhanced Routing Script object (Name=<Project Name>.<IPD name>.<Interaction Queue block name>.Routing) per Interaction Queue block in the IPD being published. The Application/url property of this Enhanced Routing Script object refers to the Queue IPD SCXML url (if deployed). Composer does NOT create an Enhanced Routing Script object for the workflow blocks. The Workflow block Object Name property (read only property) is NOT updated.

Workbin Block Update Detail

The following updates are written to Configuration Server for all **Workbin blocks** in the Project.

- A CfgScript object of the Interaction Workbin type is created under the current tenant/Scripts folder. If the object already exists, its properties are updated.
- A CfgScript object of the Interaction Queue type is created under the current tenant/Scripts folder. The name of the object follows this format: <Workbin CfgScript object name>.PrivateQueue.

-
- A CfgScript object of the Interaction Queue View type is created under the current tenant/Scripts folder. The name of the object follows this format: <Workbin CfgScript object name>.PrivateView.
 - A CfgScript object of the Enhanced Routing type is created under the current tenant/Scripts folder. The name of the object follows this format: <Workbin CfgScript object name>.PrivateQueue.Routing.
 - A CfgScript object of the Interaction Queue View type is created under the current tenant/Scripts folder for each of this workbin user defined view. The name of the object follows this format: <Workbin CfgScript object name>.<view name>.

Starting with Composer 8.1.410.14, Composer generates one Submitter for each not-private view (<project name>.<IPD name>.<Workbin name>.<View name>.submitter). Each Submitter is published with the following parameters:

```
Submitter>Strategy=<project name>.<IPD name>.<Workbin name>.PrivateQueue.Routing  
Submitter>View=<project name>.<IPD name>.<Workbin name>.<View name>
```

Deleting Items from Configuration Server

Configuration Server objects (Enhanced Routing, Interaction Queue, Interaction Queue View, Workbin) might be deleted from the Configuration Server in following situations:

- An interaction process diagram is deleted and that IPD contained blocks for which configuration objects were created. See also Configuration Server Preferences, Delete published objects, when Interaction Process Diagram is closed or deleted option. Note that Composer must be connected to the Configuration Server in order to be able to effectively delete the Configuration objects.
- A project containing interaction process diagrams is closed or deleted and those IPD contained block(s) for which configuration objects were created. See also see Configuration Server Preferences, Delete published objects when Project is closed or deleted option. Note that Composer must be connected to the Configuration Server in order to be able to effectively delete the Configuration objects.
- An interaction process diagram is published and
 - some blocks of that IPD, for which configuration objects were created, have been deleted.
 - some blocks of that IPD, for which configuration objects were created, have been updated (for example some views were removed from an Interaction Queue block).

In all cases, the user is prompted for deletion confirmation for each Configuration Server object that Composer is going to delete.

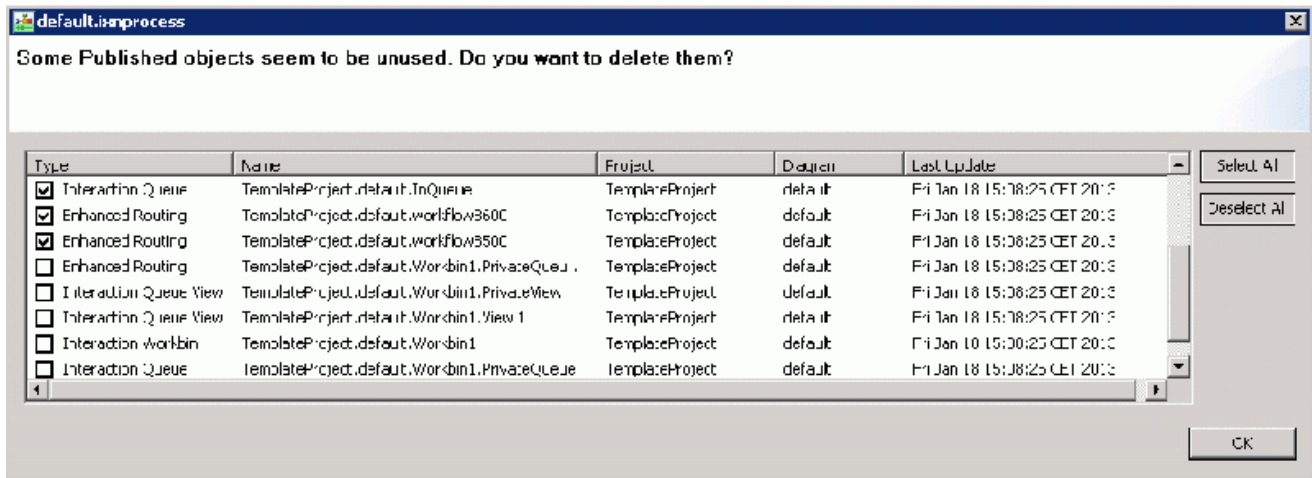

Route Flow Control Blocks

The table below summarizes the routing blocks used for flow control.

Assign Block	Use to assign a computed value/expression or a literal value to a variable
Attach Block	Use for attaching a specific interaction to the current Orchestration Server session.
Begin Parallel Block	Use to enable the design of multiple threads, such as running busy treatments in parallel files.
Branching Block	Use as a decision point in a callflow or workflow. It enables you to specify multiple application routes based on a branching condition. Depending on which condition is satisfied, the call follows the corresponding application route.
Cancel Event Block	Use to cancel a custom event.
Detach Block	Use for detaching a specific interaction from the current Orchestration Server session.
Disconnect Block	Use to invoke the Cancel Call treatment, which ends the strategy and deletes the interaction from URS memory.
ECMAScript Block	Use to build an ECMA Script expression for routing decisions.
End Parallel Block	Use to mark the end of the threads that were started by a matching Begin Parallel block.
Entry Block	All routing strategy diagrams must start with an Entry block. Defines variables that can be shared across different blocks in the same workflow. The Entry block cannot have any incoming connections.
Exit Block	Use to terminate the workflow or to return control back to calling workflow in case of subworkflow (subroutine).
Log Block	Use to log information about the application; for example, caller-recorded input that is collected while the application is running, or error messages.
Looping Block	In cases where multiple records are returned, the Looping block can loop through all the records.
Raise Event Block	Use to throw custom events.
Response Block	Sends a response to a request-based event from an external application to the Orchestration Platform.
SCXML State Block	Use to write custom SCXML code for Composer to include in the SCXML document that it generates based on the workflow diagram.
Subroutine Block	Use to invoke external SCXML documents or a sub-workflow created using Composer.

User Data	Use to update an interaction's User Data.
Wait Event Block	Use to have ORS transition out when one of the defined events is received and the associated condition is true.

Assign Common Block

Use the Assign common block to assign a computed value/expression or an entered value to a variable. Function `getSIPHeaderValue(headername)` returns the SIP header value associated with the given SIP headername. You may wish to use this function with the Assign block. By default, this option is disabled for backward compatibility. To set this preference, right-click the Project, select **Properties, Default Logging** and check **Log Assign block Variable assignments**. Applicable for both Java and .NET Projects.

Starting with 8.1.440.18, Composer Assign blocks are enhanced to generate logging statements as part of code generation. With this enhancement ORS and MCP logs will show the Assign variables and expressions.

VXML script

```
<assign name="AppState.var0" expr=""This is a callflow diagram file"" />
<log expr=""Assigning variable AppState.var0 with value ' '+This is a callflow diagram file""/>
```

SCXML script

```
<script>
    var0 = 'Welcome to workflow diagram';
    __Log('Assigning variable var0 with value ' +'Welcome to workflow diagram');
</script>
```

A new Project-level property, Default Logging, is added to control this logging capability. By default, this option is disabled for backward compatibility. Applicable for both Java and .NET Projects.

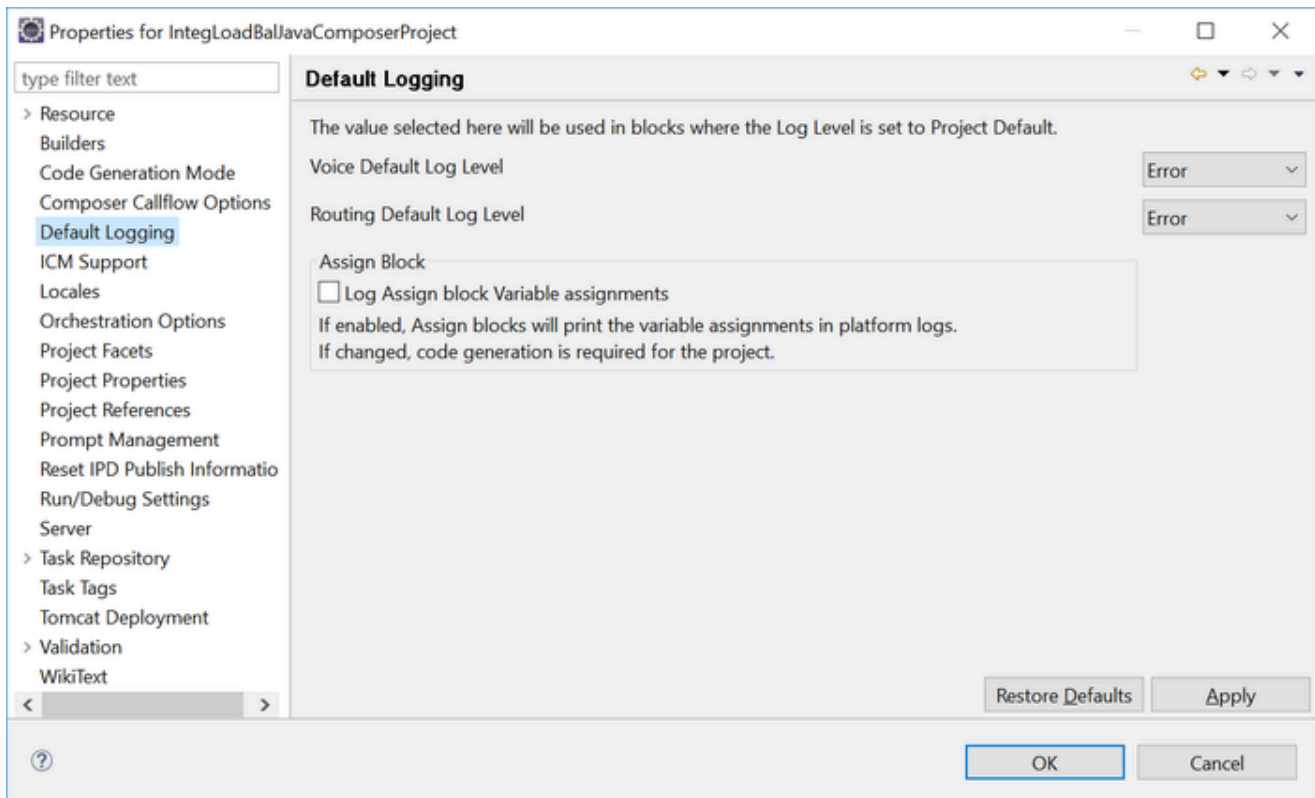

The Assign block has the following properties:

Name Property

Find this property's details under [Common Properties for Workflow Blocks](#).

Block Notes Property





Find this property's details under [Common Properties for Workflow Blocks](#).

Assign Data Property

This property assigns a value (expression) to a variable. You select the **variable** and then enter an expression, either a literal or one created in [Expression Builder](#).



To select a variable and assign a value:

1. Click the **Assign Data** row in the block's property table.

2. Click the  button to open the Assign Data to Variables dialog box.
3. Click in the **Variable** field to display a down arrow.
4. Click the down arrow and select a variable whose value will be evaluated to determine the branching condition. Default application variables are described in the [Entry](#) block for voice applications and the [Entry](#) block for routing applications. You can also use a custom variable.
5. Click under Expression to display the  button.
6. Click the  button to open Expression Builder. For examples of how to use Expression Builder, see the [ExpressionBuilder](#) topic.
7. Select an operator for the branching condition. Your variable's value will be equal to (==), less than (<), greater than (>), less than or equal to (<=), greater than or equal to (>=) or not equal to (!=) to value you enter in the Expression field.
8. In the Expression field, create a value to compare to the variable's value. Enclose the value in single quotes (' ').
9. Click the  button to validate the expression. Syntax messages appear under the Expression Builder title.
10. Click **OK** to close Expression Builder and return to the Assign Data to Variables dialog box.
11. You can make multiple variable/value assignments. Click the **Add** button if you wish to add more assignments and repeat the steps above.

Editing Expressions

To edit an expression:

1. Click its row under Expression in the Assign Data to Variables dialog box. This causes the  button to appear.
2. Click the  button to re-open Expression Builder where you can edit the expression.

Exceptions Property

Find this property's details under [Common Properties for Workflow Blocks](#).

- For callflows, invalid ECMAScript expressions may raise the following exception event: `error.semantic`.
- For workflows, invalid ECMAScript expressions may raise the following exception events: `error.script.SyntaxError`, and `error.script.ReferenceError`.

You can use [custom events](#) to define the ECMAScript exception event handling.

Condition Property

Find this property's details under [Common Properties for Workflow Blocks](#).

Logging Details Property

Find this property's details under [Common Properties for Workflow Blocks](#).

Log Level Property

Find this property's details under [Common Properties for Workflow Blocks](#).

Enable Status Property

Find this property's details under [Common Properties for Workflow Blocks](#).

ORS Extensions Property

Starting with 8.1.4, Composer blocks used to build routing applications (with the exception of the Disconnect and EndParallel blocks) add a new [ORS Extensions](#) property.

Attach Block

Use the Attach block for attaching a specific interaction to the current [Orchestration Server](#) session. For more information see `<attach>` in the *Orchestration Server Developer's Guide*, [Interaction Interface Action Elements](#).

The Attach block has the following properties:

Name Property

Find this property's details under [Common Properties](#).

Block Notes Property

Find this property's details under [Common Properties](#).

Exceptions Property

This property provides the ability to define a set of exceptions handled by this block. Any exception not caught by a block in a thread might be caught by the enclosing [Begin Parallel block](#). Find more detail under [Common Properties](#).

Condition Property

Find this property's details under [Common Properties](#).

Logging Details Property

Find this property's details under [Common Properties](#).

Log Level Property

Find this property's details under [Common Properties](#).

Interaction ID Property

This property specifies the ID of the Interaction to attach to this Orchestration Server session. Set to a meaningful value or keep the default value, which is the system variable InteractionId. Find more details under [Common Properties](#).

Enable Status Property

Find this property's details under [Common Properties](#).

ORS Extensions Property

Starting with 8.1.4, Composer blocks used to build routing applications (with the exception of the Disconnect and EndParallel blocks) add a new [ORS Extensions](#) property.

Begin Parallel Block

Use this block to enable the design of multiple threads, such as running busy treatments in parallel files. A thread is a list of blocks that run one after another. Use the [End Parallel block](#) to mark the end of the threads that were started by a matching Begin Parallel block. Starting with 8.1.2, Composer removes the restriction on the type of blocks that can be used in a busy treatments chain in 8.1.0 and earlier. Blocks such as the ECMAScript block, Database blocks, and so on, are now usable in busy treatment chains. Blocks that work on an interaction or create new interactions may not be used as busy treatments.

Name Property

Find this property's details under [Common Properties](#).

Block Notes Property

Find this property's details under [Common Properties](#).

Exceptions Property

Find this property's details under [Common Properties](#).

Condition Property

Find this property's details under [Common Properties](#).

Logging Details Property



Find this property's details under [Common Properties](#).

Log Level Property

Find this property's details under [Common Properties](#).

Body Property

This property represents the SCXML that is mandatorily executed in the Parallel block before the parallel regions or legs begin to execute. This is useful for initialization of variables or other logic that should be completed before parallel regions begin to execute.

1. Click opposite **Body** under **Value**. This brings up the  button.
2. Click the  button to bring up the Configure Body dialog box.



3. Enter the executable content of the <state> element. . All content (children) of the state are editable. You also have the option of adding code to <onentry> and <onexit>.
4. When through, click **OK**. Note: The editor does not validate against the SCXML schema.

Complete All Threads Property

This property controls when Orchestration Server is to transition out of the <parallel> structure.

Threads Property

block will have a Threads property to specify the number of threads to run in parallel. The number of output will be automatically adjusted accordingly.

Enable Status Property

Find this property's details under [Common Properties](#).

ORS Extensions Property

Starting with 8.1.4, Composer blocks used to build routing applications (with the exception of the Disconnect and EndParallel blocks) add a new [ORS Extensions](#) property.

Branching Common Block

The Branching block is used for both routing and voice applications. For an example of using the branching block in a strategy, see the [Your First Application](#) topic. Use the Branching block as a decision point in a callflow or workflow. It enables you to specify multiple application routes based on a branching condition. Depending on which condition is satisfied, the call follows the corresponding application route. A default path is automatically created once the conditions have been defined. If the application cannot find a matching condition, it routes the call to the default flow. **Note:** To support creating multiple [views](#) per interaction queue, the Branching block is available when [creating an IPD](#).

Date/Time Functions

You can open [Expression Builder](#) from the [Condition](#) property and access the following date/time URS functions (**Data Category=URS Functions > Data Subcategory=genesys**):

- `_genesys.session.timeInZone(tzone)`
- `_genesys.session.dayInZone(tzone)`
- `_genesys.session.dateInZone(tzone)`
- `_genesys.session.day.Wednesday`
- `_genesys.session.day.Tuesday`
- `_genesys.session.day.Thursday`
- `_genesys.session.day.Sunday`
- `_genesys.session.day.Saturday`
- `_genesys.session.day.Monday`
- `_genesys.session.day.Friday`

The Branching block has the following properties:

Exceptions Property

The Branching block has no page exceptions.

Name Property

Find this property's details under [Common Properties for Workflow Blocks](#).

Block Notes Property

Find this property's details under [Common Properties for Workflow Blocks](#).

Condition Property

Find this property's details under [Common Properties for Workflow Blocks](#).

Conditions Property

Selecting this property open a dialog box with Name, Expression, and Post Action columns. Here you have the option of specifying some ECMAScript code to be executed when a condition evaluates to true and the branching path is selected. Any javascript code you type in Post Action column will be executed as part of the <transition> body related to the condition.

Exceptions Property

Find this property's details under [Common Properties for Workflow Blocks](#). You can also define [custom events](#).

Ignore Script Errors Property

This property is related to the Conditions property, Post Action column. Any scripting error raised while executing the Post Action code is discarded when the Ignore Script Errors property is set to true.

Logging Details Property

Find this property's details under [Common Properties for WorkflowBlocks](#).

Log Level Property

Find this property's details under [Common Properties for Workflow Blocks](#).

Enable Status Property

Find this property's details under [Common Properties for Workflow Blocks](#).

ORS Extensions Property

Starting with 8.1.4, Composer blocks used to build routing applications (with the exception of the Disconnect and EndParallel blocks) add a new [ORS Extensions](#) property.

Cancel Event Block

Use cancel a custom event. You specify the event name and a message, which is selection of a dynamic variable. It is a terminating block (can end an application instead of an Exit block). Orchestration Server 8.1.2+ versions are required for Raise and Cancel Event blocks.

The Cancel Event block has the following properties:

The Cancel Event block has no page exceptions.

Name Property

Find this property's details under [Common Properties for Workflow Blocks](#).

Block Notes Property

Find this property's details under [Common Properties for Workflow Blocks](#).

Condition Property

Find this property's details under [Common Properties for Workflow Blocks](#).

Exceptions Property

Find this property's details under [Common Properties for Workflow Blocks](#).

Logging Details Property

Find this property's details under [Common Properties for Workflow Blocks](#).

Log Level Property

Find this property's details under [Common Properties for Workflow Blocks](#).

Request Id Property

Select the variable containing the request ID.

Enable Status

This property controls whether or not a block contributes code to the application. You may wish to use this property if there is a need to temporarily remove a block during debugging or, for other reasons during development, temporarily disable a block. This saves the effort of having to remove the block and then add it back later.

ORS Extensions Property

Starting with 8.1.4, Composer blocks used to build routing applications (with the exception of the Disconnect and EndParallel blocks) add a new **ORS Extensions** property.

Detach Block

Use the Detach block for detaching a specific interaction from the [Orchestration Server](#) session. For more information see the *Orchestration Server Developer's Guide*, `<detach>` interface action element. The Detach block has the following properties:

Name Property

Find this property's details under [Common Properties](#).

Block Notes Property

Find this property's details under [Common Properties](#).

Exceptions Property

This provides the ability to define a set of exceptions handled by this block. Any exception not caught by a block in a thread might be caught by the enclosing Begin Parallel block. Find more details under [Common Properties](#).

Condition Property

Find this property's details under [Common Properties](#).

Logging Details Property

Find this property's details under [Common Properties](#).

Log Level Property

Find this property's details under [Common Properties](#).

Interaction ID Property

This property specifies the ID of the Interaction to detach from this ORS session. Set to a meaningful value or keep the default value, which is the system variable InteractionId. Find more details under [Common Properties](#).

Pass Context

This property accepts true/false values. When set to true and Detach is also true:

- URL built with the block name is stored into this interaction's user data (user data key name is '_composer_originating_session') just before detaching the interaction. That URL will be used by the orchestration destination session (that is the new orchestration session started to handle the interaction after it was redirected to an other routing point) to request the context of the originating session. After the processing for this block is over, the originating session is blocked until the destination session actually reads the context. The context consists of the system and user [variables](#).

Pass Context Timeout

This property can be passed a positive integer value or a variable. This is the maximum time to wait (in seconds) for the destination session to read the originating session's context.

Enable Status Property

Find this property's details under [Common Properties](#).

ORS Extensions Property

Starting with 8.1.4, Composer blocks used to build routing applications (with the exception of the Disconnect and EndParallel blocks) add a new [ORS Extensions](#) property.

Disconnect Block Routing

Use to disconnect the caller and end the call. The Disconnect block invokes the CancelCall treatment, which ends the workflow and deletes the interaction from URS memory. The Disconnect block has the following properties:

Name Property

Find this property's details under [Common Properties](#).

Block Notes Property

Find this property's details under [Common Properties](#).

Exceptions Property

Find this property's details under [Common Properties](#).

Interaction ID Property

Set to a meaningful value or keep the default value, which is the system variable InteractionId. Find more details under [Common Properties](#).

Terminate Session Property

Select true or false.

Condition Property

Find this property's details under [Common Properties](#).

Logging Details Property

Find this property's details under [Common Properties](#).

Log Level Property

Find this property's details under [Common Properties](#).

Enable Status Property

Find this property's details under [Common Properties](#).

Single Session Treatments

When using the Play Application, Play Sound (Music and ARM Types) Exit, and Disconnect blocks, voice applications can now optionally use a single VXML session on Media Control Platform to play/run multiple treatments instead of using one session per treatment. This enables DTMF buffering between multiple MSML treatments. For more information, see [Single Session Treatments](#).

ECMAScript Block

Orchestration Server (ORS) 8.0+ supports **SCXML** plus ECMAScript as a routing language for use in Composer when creating routing workflows. While the core SCXML provides State Chart functionality, you can specify ORS-specific instructions, such as conditions that can be used for routing decisions, in the form of ECMAScript. The Script property brings up Composer's Expression Builder for creating those conditions in the form of expressions. Use the ECMAScript block to build an ECMAScript expression.

Notes:

- The ECMAScript block supports general ECMAScript in addition to ORS-specific **Extensions**.
- If the Composer Project contains a folder at include/user, then any files with extension .js will be included in the generated SCXML. This allows you to write custom ECMAScript and include it in the application.
- To support creating multiple **views** per interaction queue, the ECMAScript block is available when **creating an IPD**.
- To set external event processing when transitioning out of ECMAScript blocks, select Properties from the Project menu. A dialog box opens showing the properties of the selected Project or of the Project that contains the selected resource. Select Orchestration Server Options to set **external event processing**.
- Also see the **SCXML State Block**.

Important

Composer currently supports ECMAScript (ES) 5.

The ECMA Script block has the following properties:

Name Property

Find this property's details under **Common Properties**.

Block Notes Property

Find this property's details under **Common Properties**.

Exceptions Property

Find this property's details under [Common Properties](#).

- For callflows, invalid ECMAScript expressions may raise the following exception event: `error.semantic`
- For workflows, invalid ECMAScript expressions may raise the following exception events: `error.script.SyntaxError` and `error.script.ReferenceError`

You can use [custom events](#) to define the ECMAScript exception event handling.

Condition Property

Find this property's details under [Common Properties](#).

Logging Details Property

Find this property's details under [Common Properties](#).

Log Level Property



Find this property's details under [Common Properties](#).

Enable Status Property

Find this property's details under [Common Properties](#).

Script Property

To create an ECMAScript expression in [Expression Builder](#):

1. Click opposite **Script** under **Value**. This brings up the  button.
2. Click the  button to bring up Expression Builder.

Expression Builder gives access to various [categories of data](#), which can be used in expressions. To create an expression, follow the instructions in the [Creating Expressions](#) topic.

Excluding Agents

Note: When `_genesys.queue.excludeAgents` is used in a routing workflow before a Target block, the URS-provided list of excluded agents will be applied to the current or any future Target block. The effect of the `_genesys.queue.excludeAgents` execution can be cancelled only by the execution of another `_genesys.queue.excludeAgents` or if URS stops this interaction processing.

ORS Extensions Property

Starting with 8.1.4, Composer blocks used to build routing applications (with the exception of the Disconnect and EndParallel blocks) add a new **ORS Extensions** property.

Using Genesys Extensions

Assume you expand Orchestration Server Functions in Expression Builder.

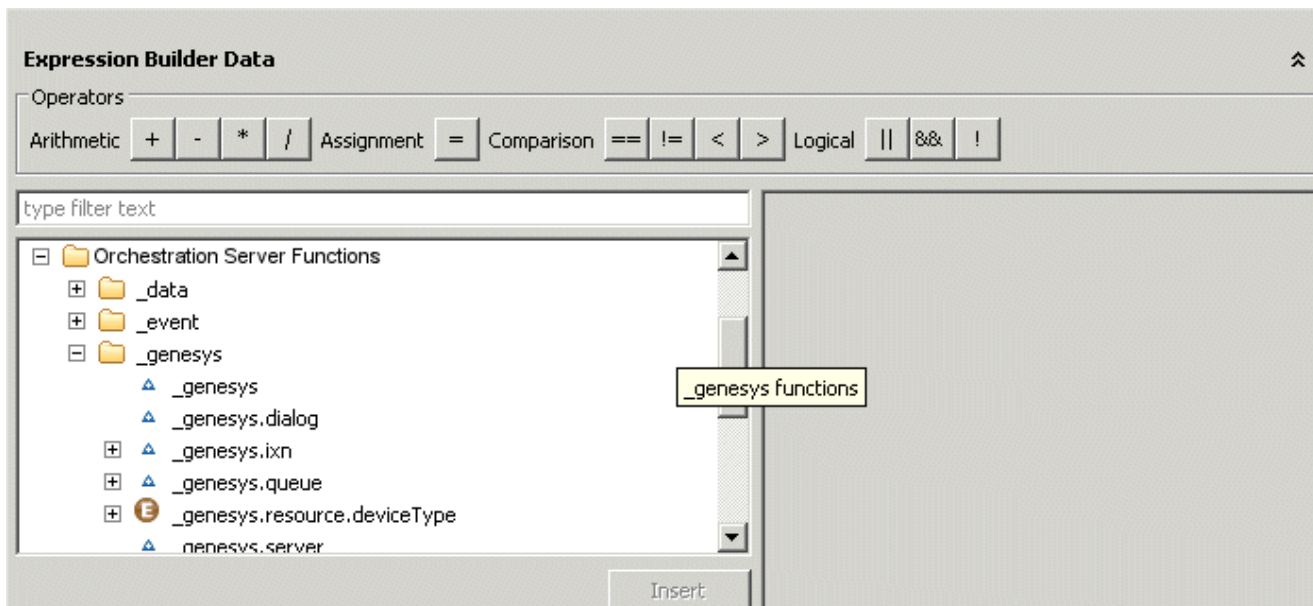

The Orchestration Server Functions category shows various Genesys-supplied Orchestration Extensions described in the *Orchestration Server Developer's Guide*, such as the `genesys.queue.checkAgentState` extension shown below. Also, the *Universal Routing 8.1 Reference Manual* describes many URS equivalent functions, which have similar names but are not necessarily equivalent. For example, the Functions chapter of that manual describes a `CheckAgentState` function. These functions are intended to be called in *Interaction Routing Designer*, which was historically used to create routing strategies prior to Composer.

Assume you double-click `genesys.queue.checkAgentState`. Expression Builder now appears as shown below.

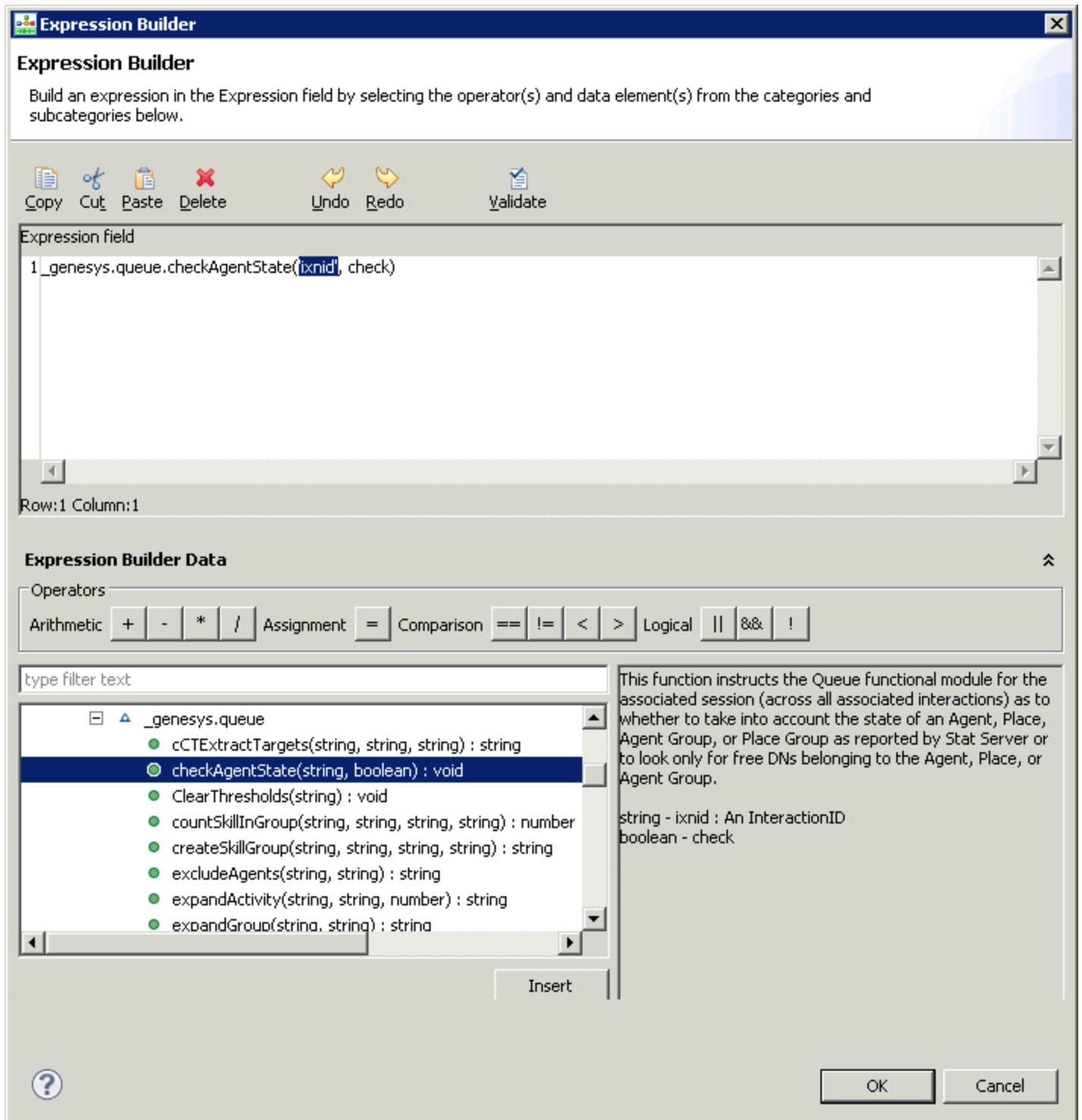

ECMA1.gif

In this case, the `genesys.queue` module implements the target selection functionality of URS (finding resources for interactions and delivering interactions to the resource). When URS executes these extensions, it returns events back to the instance of logic running the SCXML document that requested the action.

End Parallel Block

This block works with the [Begin Parallel Block](#) to enable the design of multiple threads. Use the End Parallel block to mark the end of the threads that were started by a matching Begin Parallel block.

Name Property

Find this property's details under [Common Properties](#).

Block Notes Property

Find this property's details under [Common Properties](#).

Condition Property

Find this property's details under [Common Properties](#).

Logging Details Property

Find this property's details under [Common Properties](#).

Log Level Property

Find this property's details under [Common Properties](#).

Enable Status Property

Find this property's details under [Common Properties](#).

ORS Extensions Property

Starting with 8.1.4, Composer blocks used to build routing applications (with the exception of the Disconnect and EndParallel blocks) add a new **ORS Extensions** property.

Entry Block and Variables

Use the Entry block to:

- Set global error (exception) handlers.
- Define global [variables for the workflow](#).

All workflow and callflow diagrams must start with an Entry block, which cannot have any incoming connections. There are different Entry blocks for routing workflows and [voice callflows](#). The Entry block is used as the entry point for a main workflow or subworkflow (subroutine). Composer throws a validation message if the Entry block is missing or more than one is added.

The Entry block defines the initial entry state for interactions, all global state variables, and the datamodel. In the SCXML code for the workflow, all subsequent blocks are added as child states inside the Entry block's state. This allows the event handlers in the Entry block to act as global event handlers for the entire workflow. Any events not caught at the local level (for individual blocks) are caught at the global level by the Event handlers in the Entry block.

The Entry block global variables define the State for the application and are maintained as the <datamodel> in the SCXML engine. The [Back End](#) block provides a Pass State property to pass state information to the Server side.

An Entry block user-defined variable can be used to access the results of a Stored Procedure call specified in a [DB Data block](#) for both voice and routing applications. Note: [Outlinks](#) starting from the Entry block cannot be renamed or assigned a name through the Properties view.

The Entry block has the following properties:

Name Property

Find this property's details under [Common Properties](#).



Block Notes Property

Find this property's details under [Common Properties](#).

Exceptions Property

Use this property to define which exceptions or events to handle at the Entry block. This block contributes a state in the generated SCXML code that is a parent state for all blocks in a Workflow.

This allows an event received for any of the workflow blocks to be handled at the Entry block.

1. Click opposite **Exceptions** under **Value**. This brings up the  button.
2. Click the  button to bring up the Exceptions dialog box. The sample below shows the dialog with the `interaction.deleted` event selected.

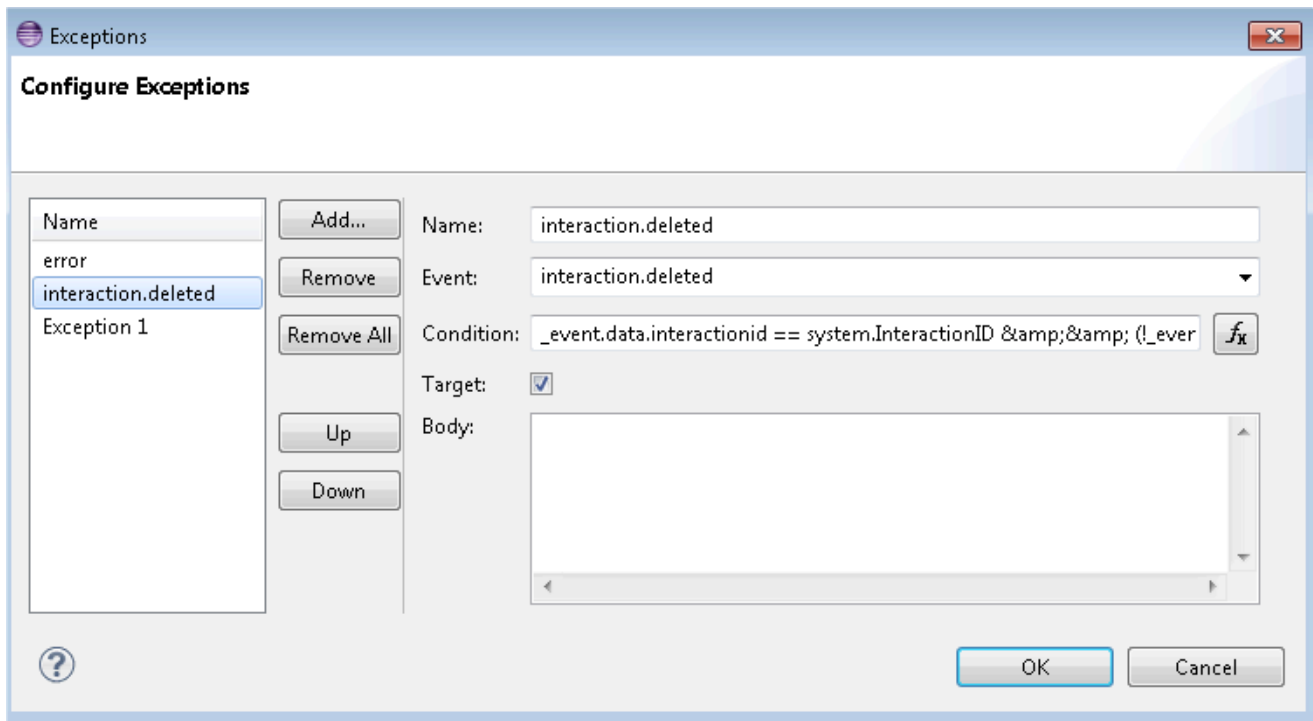

Starting with 8.1.410.14, a result of guard condition check is now made when processing eServices/child interactions. The Entry block `interaction.deleted` event handlers are updated with the following guard conditions:

- Current interaction deletion.
- The `interaction.deleted` event is from an interaction deletion and not from a detach operation.

```
_event.data.interactionid == system.InteractionID && (!_event.data.resultof ||
_event.data.resultof == 'deletion')
```

3. Click **Add** to add new exceptions to the list of handled exceptions.
4. For each exception, specify a unique name and an exception event. Also see [handling eServices Switchovers](#).
 - **Name**--Composer uses the name of the exception to label the output.
 - **Event**--Use to select the specific exception event.
 - **Condition**--The guard condition for this exception, which you define in [Expression Builder](#). The exception is selected only if the condition evaluates to true.

- **Target**--If true, an exception port is created and the user can connect it to the block this exception will transition to when it is executed. If false, the exception will not cause a change in the state configuration when it is executed. The executable content contained in the exception will still be executed, so the exception will function as a simple exception event handler.
- **Body**--(optional) Executable scxml code that will be executed when this event is received and any specified condition evaluates to true. This code is executed before any other blocks that are connected as this exception's event handlers.

5. When done with the dialog box, click **OK**.

You can also find general information on the Exceptions property under [Common Properties](#).

Variables Property

You have the option of defining [application variables](#) in the Entry block ([Application variables](#) can also be defined outside the Entry block via the toolbar). Variable descriptions entered in the Entry block are visible when selecting the variable for use in other blocks, such as the [Assign](#) block. Composer supports passing variables between a workflow and [sub-workflow](#). To view variables:

1. In the Properties tab, click opposite Variables under Value to display the  button.
2. Select Project, System, or User Variables.
3. Click the arrow to display the selected type. An example System Variables dialog box is shown below.

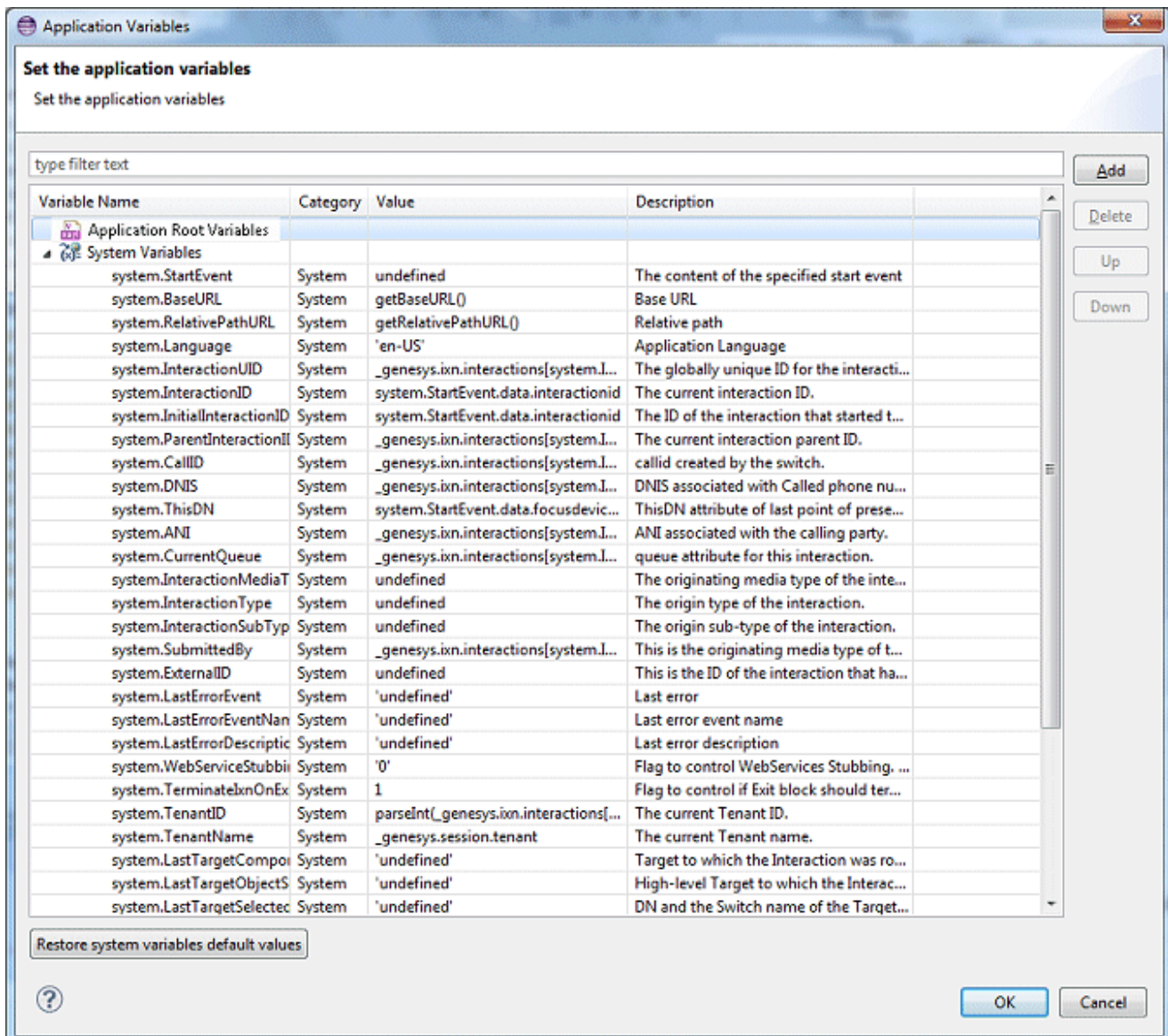

The Entry block lists all the variables associated with the workflow. Composer supports the following types of variables for workflow diagrams in the Entry block:

- **Predefined system variables**, which cannot be edited or deleted, but applications can modify their values.
- **Project variables** local to the diagram file.
- **Input variables**, which are only used for Subroutines. These are user-defined and should be passed from the main diagram to the called Subroutine diagram file.

Starting with 8.1.410.14 you can:

- Invoke the Entry Block variables dialog when a property is selected in the Properties view using ALT+V.
- Enable Composer to automatically declare variables in a Main callflow to match input/output variable

names in Sub-callflows and automatically perform the mapping. For more information, see the **auto synchronization** option in [Diagram Preferences](#).

Also see:

- The DB Data Common Block, Column Names and Records Variable properties.
- The User Data Block, Variable Naming section.

Restore System Variables Default Values

Projects created in earlier versions of Composer may throw runtime errors due to incorrectly initialized system variables after upgrading to Composer 8.1.3. This was due to changes in how system variables are stored and handled in 8.1.3. To resolve this, the Entry block Variables dialog contains a button to restore system variables to default values. This can be used to reset variables and fix initialization. However, this also removes any custom values set in system variables. After resetting system variables, these custom values will need to be set again.

When upgrading to 8.1.4+ versions from prior 8.1.300.58 versions, make sure the workflow diagram Entry Block System variables have the latest default values. If not, workflow diagram file validation generates a warning message in the Problems view: System variables have non-default values. To restore the System variables to Composer-supplied default values, open the Entry Block > Variables dialog and use the **Restore system variables default values** button to reset the system variables.

Defining Variables

Important! When defining a variable name, the name:

- Must not start with a number or underscore.
- May consist of letters, numbers, or underscores.

When you define and initialize a variable that is expected to be played as a date later on in the workflow, define the value using the following format: `yyyymmdd`. Example: `MyDate=20090618`. You must use this format; Composer does not perform any conversions in this case. When you define and initialize a variable that is expected to be played as a time later on in the workflow, define a 12 hour-based value using the following format: `hhmmssa` or `hhmmssp`. Examples: `MyTime=115900a` or `MyTime=063700p`. Define a 24 hour-based value using the following format: `hhmmssh` Example: `MyTime=192000h`. You must use this format; Composer does not perform any conversions in this case. **Default Application Variables** See the [Variables: Project and Workflow](#) topic. **Adding a New Variable** To add a new variable in the Application Variables dialog box:

1. Click **Add**. Composer add a row for variable and generates a temporary name and number; for example: `var7`.
2. Select the row and supply the **Name**, **Type**, **Value**, and **Description** fields.
3. Click OK.

Variable Name You can use the Variable name field for either of the following purposes:

- To enter the name of a new variable.
- To change the name of an existing variable. To do this, select an existing variable from the list of variables. The variable's name appears in the Variable box, and you can change its value in the Value box.

Excluded Characters The Variable name field will not accept the following special characters:

- less-than sign (<)
- greater-than sign (>)
- double quotation mark (")
- apostrophe (')
- asterisk (*)
- ampersand (&)
- pound (#)
- percentage (%)
- semi colon (;)
- question mark (?)
- period (.)
- all characters that are considered ECMAScript operators; example: "-"

The variable Value field will not accept the following special characters:

- less-than sign (<)
- greater-than sign (>)
- double quotation mark (")
- apostrophe (')
- ampersand (&)
- plus sign (+)
- minus sign (-)
- asterisk (*)
- percentage (%)

Condition Property

Find this property's details under [Common Properties](#).

Logging Details Property

Find this property's details under [Common Properties](#).

Log Level Property

Find this property's details under [Common Properties](#).

Enable Status Property

Find this property's details under [Common Properties](#).

ORS Extensions Property

Starting with 8.1.4, Composer blocks used to build routing applications (with the exception of the Disconnect and EndParallel blocks) add a new [ORS Extensions](#) property.

Refactoring Variables

Starting with Composer 8.1.450.33, when you rename a variable in the Entry block's **Application Variables** dialog and click **OK**, a new refactoring dialog is displayed as follows:

`thumb|center|300px`

The refactoring dialog displays the other impacted instances of the variable you are renaming. Previously, when a variable was refactored, Composer displayed validation error messages to notify users to change the variable name in other impacted blocks, only when the particular diagram was validated. This new feature allows users to select variables to be refactored in the different impacted blocks of a diagram when they rename any variable in the Entry block.

- Select the instances that you want to refactor and click **OK**. The selected variables are refactored. If you close the refactoring dialog before the process completes, the operation is cancelled.

Important

If you do not want to refactor any of the listed instances through the dialog, click Cancel and then click OK on the confirmation dialog to update the variables manually.

- Once the process is completed, a confirmation dialog is displayed.

- If any errors are encountered during the process, a dialog listing the exceptions is displayed. You can revert any changes using the **Revert** option on this dialog.

Important

Refactoring does not automatically save the diagram file. The diagram file must be saved manually.

Note: For variables that you do not select from the refactoring dialog, Composer generates validation error messages (after diagram validation) to notify users to manually change those variables' names in the impacted blocks.

The following objects are not considered while refactoring:

- VXML Form Block (in Callflows)
- SCXML State Block (in Workflows)
- ECMA Script Block (in Workflows)
- Script Block (in Callflows)
- Project Variables in Workflow Diagrams
- Root Document Variables in Callflow Diagrams

Important

This feature is enabled by default. To turn it off, deselect the **Enable Variable Refactoring** option under **Preferences > Composer Diagram**.

Exit Block Routing

Use to terminate the workflow or to return control back to calling workflow in case of a subworkflow (subroutine). Every strategy flow must have at least one Exit block (multiple Exit blocks are allowed, such as when using the [Branching](#) block). Composer generates a validation message if an Exit block is missing. If a workflow does not perform target selection and reaches the Exit block, the call is default routed to the default destination in Configuration Server, which is a configured DN. For more information, see option `default_destination` in the [Universal Routing 8.1 Reference Manual](#). The Exit block has the following properties:

Name Property

The Name property is present in all blocks in Composer. The Name property is the first property for all blocks.

- Use the Value field beside in the Name property row of the block's property table to name the block. Block names should conform to ECMAScript and SCXML identifier naming conventions, and they are limited to a maximum of 255 characters.
- Names may consist only of numbers, letters, or initial underscores (_).
- Names should only begin with a letter or underscore.
- Names can end only with a letter or a number.
- Except for the Entry and Exit blocks, you should give all blocks a descriptive name. For example, if an Input block asks the caller to input an account number, then the name of the block could be `Input_Account_Number`.
- The name of the block is used as the Name of the `<form>` tag that gets generated for that block.

To provide a name for a block:

1. Select the Name row in the block's property table.
2. In the Value field, type a block name that conforms to the restrictions above.

Block Notes Property

Find this property's details under [Common Properties](#).

Condition Property

Find this property's details under [Common Properties](#).

Logging Details Property

Find this property's details under [Common Properties](#).

Log Level Property

Find this property's details under [Common Properties](#).

Enable Status Property

Find this property's details under [Common Properties](#).

Interaction ID Property

Set to a meaningful value or keep the default value, which is the system variable `InteractionId`. Can be used for "interaction-less" processing for scenarios where the `InteractionId` variable is not automatically initialized, but instead must wait for an event. An example would be an SCXML application triggered by a Web Service that does not add an interaction. Background: Previous to 8.1.1, Composer did not expose an Interaction ID property. Instead, when ORS started processing an interaction, a generated SCXML application automatically initialized the system variable, `InteractionId`. This variable was then used internally by Routing and certain eServices blocks when interacting with ORS. With the introduction of support for Interaction-less processing, you can now define a specific event (**IPD** (Event property) to initialize `InteractionId`, or not define an event at all. For scenarios with an interaction (`IPD Diagram/Event=interaction.present` for example), you may keep the default value for the Interaction ID property. The default value is the system variable `InteractionId`, which is initialized automatically in this case. For other scenarios (any scenario where the system variable `InteractionId` is not set), you may choose to:

1. Not use blocks that require an Interaction ID
2. And/or set the Interaction ID property to a meaningful value
3. And/or assign a meaningful value to the `InteractionId` system variable

Return Values Property

This property is visible only for subworkflows. Use to specify the variable(s) whose value(s) will be returned once the Exit block is executed. To select return variables:

1. Click the **Return Values** row in the block's property table.
2. Click the  button to open the **Return Values** dialog box.

3. Select individual variables, or click **Select all** or **Deselect all** as needed.
4. Click OK to close the **Return Values** dialog box.

ORS Extensions Property

Starting with 8.1.4, Composer blocks used to build routing applications (with the exception of the Disconnect and EndParallel blocks) add a new **ORS Extensions** property.

Single Session Treatments

When using the Play Application, Play Sound (Music and ARM Types) Exit, and Disconnect blocks, voice applications can now optionally use a single VXML session on Media Control Platform to play/run multiple treatments instead of using one session per treatment. This enables DTMF buffering between multiple MSML treatments. For more information, see [Single Session Treatments](#).

Response Block

The Response block works with the <response> Action Element, an Orchestration Server extension, which can be used in SCXML code. For more information, see the *Orchestration Server Developer's Guide*, Core Extensions, Web Services Interface, [Action Elements](#), <response> Action Element.

Use the Responses block to send a response to a request-based event from an external application to the [Orchestration Platform](#).

In summary, the Response block:

- Waits for and responds to a particular request sent to Orchestration Server's HTTP interface.
- Responds to a particular request that was received earlier and referenced by its `_sendid`.
- Supports a timeout capability to transition out if no request is received within a specified time range.
- Reads parameters from the request.
- Specifies parameters in the response.

Name Property

Find this property's details under [Common Properties for Workflow Blocks](#).

Block Notes Property

Find this property's details under [Common Properties for Workflow Blocks](#).

Exceptions Property

This property provides the ability to define a set of exceptions handled by this block. Find more detail under [Common Properties](#).

Condition Property

Find this property's details under [Common Properties for Workflow Blocks](#).

Logging Details Property

Find this property's details under [Common Properties for Workflow Blocks](#).

Log Level Property

Find this property's details under [Common Properties for Workflow Blocks](#).

Event Property

Use this optional property to store the content of the request (JSON data) in a variable. Click the down arrow and select a variable. The default value is `system.ANI` set in the Entry block, Variables property.

Request ID Property

Use `requestid` to create an expression identifying the request to which the Response block is going to reply. Expression Builder will show `_event.sendid` representing the request that was received earlier. The default value is `_event.sendid` where `_event` is the last event received by this session.

Requests Property

When this property is specified, the Response block will block the application execution (or the parallel leg of the application it belongs to) until one of the specified events is received and the (optional) associated condition expression returns `true`. The Request ID Property should be assigned to its `_event.sendid` default value.

Parameters Property

Use this property to specify parameters and values for the response to the external request.

1. Click the **Parameters** row in the block's property table.
2. Click the  button to open a dialog box and **ExpressionBuilder** for configuring the parameters and values for the response to the external request.

Result Property

Use the Result property to create a string which will represent the result code associated with the response to the external request. For more information see the *Orchestration Server Developer's Guide*, [Action Elements](#), resultcode.

Type Property

Use the Type property to specify whether the response to the external request is positive or negative. For more information, see the *Orchestration Server Developer's Guide*, [Action Elements](#), type.

Timeout Property

Use this property to select a variable containing a timeout value, which will be used to transition out if no request is received within a specified time range or keep the default of 30 (added starting with 8.1.440.18).

This property supports the following:

- Literal integer value. For example: Timeout=4 & Unit=second <send event="'WaitEvent1.wait.timeout'" delay="'4s'"/>.
- Variable with integer value. For example: Timeout=Variable(4) & Unit=second <send event="'WaitEvent1.wait.timeout'" delay="'4s'"/>.
- Variable with string value. For example: Timeout=Variable('6') & Unit=second <send event="'WaitEvent1.wait.timeout'" delay="'6s'"/>.
- Variable with string value including unit. For example: Timeout=Variable('6ms') & Unit=second <send event="'WaitEvent1.wait.timeout'" delay="'6ms'"/>. In this case, the unit specified in the variable is used instead of the static property unit.

Unit Property

Use this property to specify the units for the Timeout property.

Enable Status Property

This property controls whether or not a block contributes code to the application. You may wish to use this property if there is a need to temporarily remove a block during debugging or, for other reasons during development, temporarily disable a block. This saves the effort of having to remove the block and then add it back later.

ORS Extensions Property

Starting with 8.1.4, Composer blocks used to build routing applications (with the exception of the Disconnect and EndParallel blocks) add a new **ORS Extensions** property.

Log Common Block

Use a Log block to record information about an application. For example, you can log caller-recorded input collected while an application is running or error messages. You can use the Log block for any of the following purposes:

1. Informational - To log the application specific data
2. Error - for logging error details
3. Warning - to flag any warnings
4. Debug - for debugging

The categories in the Log Level property correspond to the above.

When used for a callflow, the Log block writes the log to the Genesys Voice Platform logs (Media Control Platform) using the VoiceXML <log> tag.

The Log block has the following properties:

The Log block has no page exceptions.

Name Property

Find this property's details under [Common Properties for Callflow Blocks](#) or [Common Properties for Workflow blocks](#).

Block Notes Property

Find this property's details under [Common Properties for Callflow Blocks](#) or [Common Properties for Workflow Blocks](#).

Exceptions Property

Find this property's details under [Common Properties for Callflow Blocks](#) or [Common Properties for Workflow Blocks](#).

For callflows, invalid ECMAScript expressions may raise the following exception events: error.semantic. For workflows, invalid ECMAScript expressions may raise the following exception events:

- `error.log.ReferenceError`

- `error.illegalcond.SyntaxError`
- `error.illegalcond.ReferenceError`

You can use [custom events](#) to define the ECMAScript exception event handling.

Condition Property

Find this property's details under [Common Properties for Callflow Blocks](#) or [Common Properties for Workflow Blocks](#).

Label Property

This property applies to workflows only. It provides meta-data for the logging details.

Logging Details Property

Find this property's details under [Common Properties for Callflow Blocks](#) or [Common Properties for Workflow Blocks](#).

Log Level Property

Find this property's details under [Common Properties for Callflow Blocks](#) or [Common Properties for Workflow Blocks](#).

Enable Status Property

Find this property's details under [Common Properties for Callflow Blocks](#) or [Common Properties for Workflow Blocks](#).

ORS Extensions Property

Starting with 8.1.4, Composer blocks used to build routing applications (with the exception of the Disconnect and EndParallel blocks) add a new [ORS Extensions](#) property.

Looping Common Block

Use this block to iterate over a sequence of blocks multiple times in the following scenarios:

1. Iterate over a sequence of blocks based on a self-incrementing counter (FOR).
2. Iterate indefinitely until an exit condition is met (WHILE).
3. Iterate over records/data returned by the [DB Data block](#) (CURSOR/FOREACH). Also, populate variables if variables mapping is defined.
4. Iterate over data returned by [Context Services blocks](#) (FOREACH). Also, populate variables if [Variables Mapping](#) is defined.
5. Iterate over JSON Array defined in the application.

For scenarios 1 and 2 above, use the Looping block with a reference to the block retrieving the data. Scenarios 3 and/or 4 can be used in conjunction with 1 or 2, in which case the loop will exit when either of the exit conditions is met.

Prerequisite

You must perform the following steps in order for the Looping block to be used to iterate over data returned by the DB Data block:

1. Create a folder named Scripts in the Project folder.
2. In the Entry block, specify a value for the Scripts property such as `../include/DBRecordSetAccess.js`

The Looping block has the following properties:

Name Property

Find this property's details under [Common Properties for Callflow Blocks](#) or [Common Properties for Workflow Blocks](#).

Block Notes Property

Find this property's details under [Common Properties for Callflow Blocks](#) or [Common Properties for Workflow Blocks](#).

Counter Initial Value Property

A Counter variable controls the number of loops. Specify the initial value by entering a positive integer (including zero) or selecting the variable that contains the initial value. Composer will increment the Counter variable after each iteration. The value of the Counter variable is available after the looping has exited. This is a mandatory property if the Counter Variable property is specified.

Counter Variable Property

Enter a name for the variable used to store the Counter value or select the variable that contains the name. This is a mandatory property if the Counter Initial Value property is specified.

Current Record Variable Property

Select a variable to be used to store the current record when iterating over records. Composer will assign the current record after each iteration. This property is ignored if the Data Source Property is not set

Data Source Property

Specify a block reference to the DB Data or a Context Services block (with [Variables Mapping](#) support) that provides the data to be iterated or select the variable that contains a JSON Array. This is a mandatory property if Counter Initial Value and Counter Variable are not specified.

Exceptions Property



Find this property's details under [Common Properties for Callflow Blocks](#) or [Common Properties for Workflow Blocks](#). You can also define [custom events](#).

Counter Max Value Property

Specify the maximum value by entering a positive integer greater than the initial value or selecting the variable that contains the maximum value. When the Counter variable reaches the maximum value, then the block connected to the Exit port is executed. This is a mandatory property if the Counter Variable property is specified or if the Data Source property is not specified.

Exit Expression Property

This property is optional. If specified, prior to each iteration the exit expression is evaluated. If true, the flow goes out via the Exit port of the block. This condition is used in conjunction with max records (if Data Source is specified) or Counter Max Value (if Counter Variable is specified). To enter an exit expression

1. Opposite the **Exit Expression** property, click under **Value** to display the  button.
2. Click the  button to open Expression Builder. For examples of how to use Expression Builder, see the [Expression Builder](#) topic.
3. Create the exit expression and click **OK**.

Condition Property

Find this property's details under [Common Properties for Callflow Blocks](#) or [Common Properties for Workflow Blocks](#).

Logging Details Property

Find this property's details under [Common Properties for Callflow Blocks](#) or [Common Properties for Workflow Blocks](#).

Log Level Property

Find this property's details under [Common Properties for Callflow Blocks](#) or [Common Properties for Workflow Blocks](#).

Enable Status Property

Find this property's details under [Common Properties for Callflow Blocks](#) or [Common Properties for Workflow Blocks](#).

ORS Extensions Property

Starting with 8.1.4, Composer blocks used to build routing applications (with the exception of the Disconnect and EndParallel blocks) add a new [ORS Extensions](#) property.

Using the Looping Block (Counter-based without a Data Source)

1. Add a Looping block and connect the previous block outputport to the Looping block.
2. Connect the Next outputport to the sequence of connected blocks.
3. Connect the outputport of the last block in the sequence in step 2 back to the looping block to form a loop.
4. Connect the Exit outputport of the looping block to the block(s) to continue processing after the loop has exited. The diagram when a looping block is used should appear as follows:

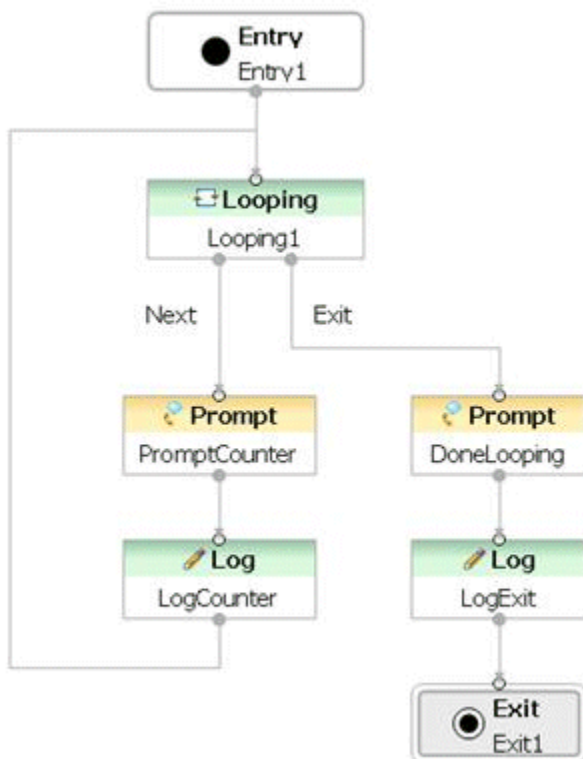

FOR loop: To iterate over the PromptCounter block 10 times, the following properties are set:

- Counter Initial Value is 1.
- Counter Variable Name is Variable(MyCounterVariable).
- Counter Max Value is 10.

WHILE loop: To iterate over the PromptCounter block until a condition is satisfied, the following property is set:

- Exit expression is loginSuccessful != true.

Using the Looping Block with a DB Data/Context Services Block

1. Add a Looping block and connect the DB Data/Context Services block output to the Looping block.
2. Connect the Next output to the sequence of connected blocks.
3. Connect the output of the last block in the sequence in step 2 back to the looping block to form a loop.
4. Connect the Exit output of the looping block to the block(s) to continue processing after the loop has exited. The diagram when a looping block is used should appear as follows:

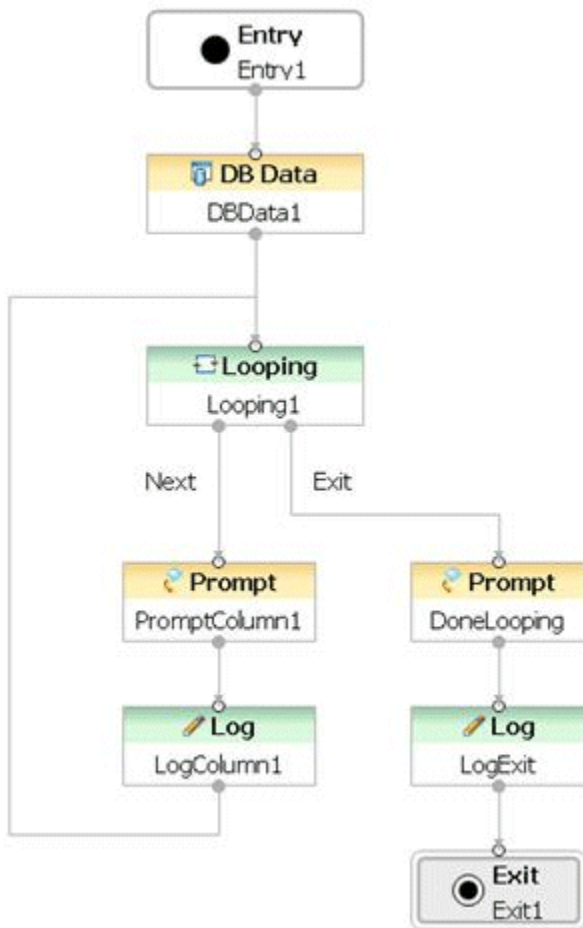

CURSOR/FOREACH loop: To iterate over the PromptColumn1 block for each record returned by the DBData1 block, the following property is set:

- Data Source = Block Reference (DBData1)

This example assumes variables were mapped for Column1 in DB Data1. If variables were not mapped, then another Assign block would be needed to store the value into a variable and the variable is then specified in the PromptColumn1 block.

Raise Event Block

Use the Raise Event block for Composer to throw custom events. You specify the event name and a message, which is selection of a dynamic variable. It is a terminating block (can end an application instead of an Exit block). Orchestration Server 8.1.2+ versions are required for Raise and Cancel Event blocks.

Also see [CustomEvents](#).

The Raise Event block has the following properties:

- The Raise Event block has no page exceptions.

Name Property

Find this property's details under [Common Properties for Callflow Blocks](#) or [Common Properties for Workflow Blocks](#).

Block Notes Property

Find this property's details under [Common Properties for Callflow Blocks](#) or [Common Properties for Workflow Blocks](#).

Delay Property

Enter the timeout or select a variable. Maps to [send delay](#).

Enter a value or select a variable. Examples are shown below using Timeout. This property supports the following:

- Literal integer value. For example: Timeout=4 & Unit=second <send event="'WaitEvent1.wait.timeout'" delay="'4s'"/>.
- Variable with integer value. For example: Timeout=Variable(4) & Unit=second <send event="'WaitEvent1.wait.timeout'" delay="'4s'"/>.
- Variable with string value. For example: Timeout=Variable('6') & Unit=second <send event="'WaitEvent1.wait.timeout'" delay="'6s'"/>.
- Variable with string value including unit. For example: Timeout=Variable('6ms') & Unit=second <send event="'WaitEvent1.wait.timeout'" delay="'6ms'"/>. In this case, the unit specified in the variable is used instead of the static property unit.

Unit Property

Select seconds or milliseconds for the delay. Maps to <send delay>.

Condition Property

Find this property's details under [Common Properties for Callflow Blocks](#) or [Common Properties for Workflow Blocks](#).

Logging Details Property

Find this property's details under [Common Properties for Callflow Blocks](#) or [Common Properties for Workflow Blocks](#).

Log Level Property

Find this property's details under [Common Properties for Callflow Blocks](#) or [Common Properties for Workflow Blocks](#).

Event Property

Maps to [send event](#). Enter a value or select a variable.

Parameters Property

Add a list of key-values. Maps to <param>.

Enable Status

This property controls whether or not a block contributes code to the application. You may wish to use this property if there is a need to temporarily remove a block during debugging or, for other reasons during development, temporarily disable a block. This saves the effort of having to remove the block and then add it back later.

ORS Extensions Property

Starting with 8.1.4, Composer blocks used to build routing applications (with the exception of the Disconnect and EndParallel blocks) add a new **ORS Extensions** property.

SCXML State Block

Use to write custom SCXML code for Composer to include in the SCXML document that it generates based on the workflow diagram. The SCXML State block has the following properties:

Name Property

Click under Value and enter the block name. Composer will use the name to identify the block in the diagram and as the state name in the SCXML code.

Block Notes Property



Find this property's details under [Common Properties](#).

Exceptions Property

Use to configure the exception nodes, with each port being hooked up to an event configured by you and selectable using Add Custom Event. Find this property's details under [Common Properties](#).

Body Property

This property contains all the executable content of the <state> element (<onentry>, <onexit>, <final>, ...).

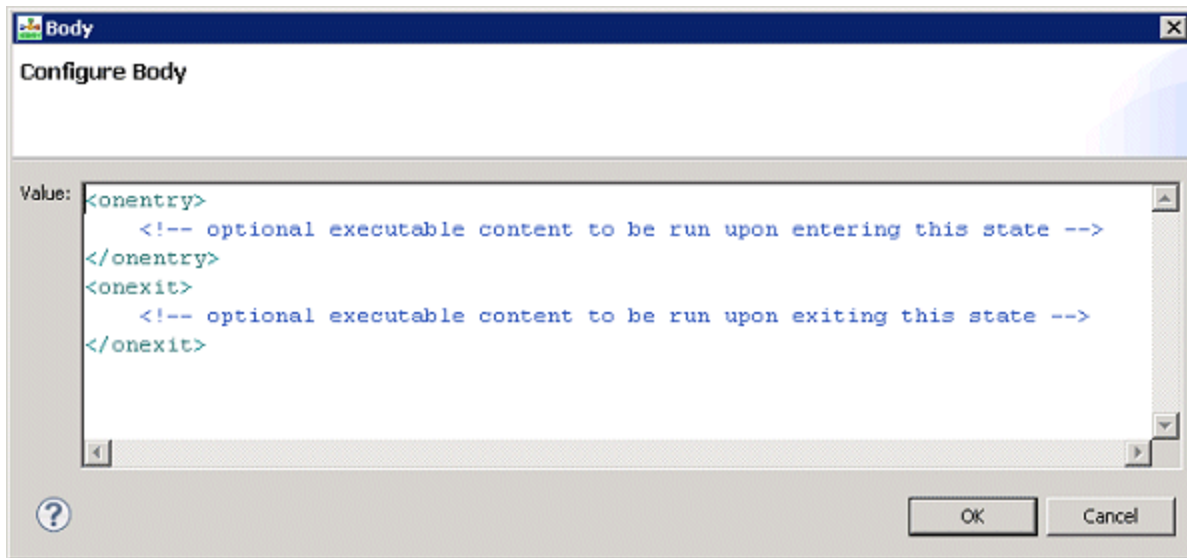

1. Click opposite **Body** under Value. This brings up the  button.
2. Click the  button to bring up the Configure Body dialog box.



3. Enter the executable content of the `<state>` element. . All content (children) of the state are editable. You also have the option of adding code to `<onentry>` and `<onexit>`.
4. When through, click **OK**. Note: The editor does not validate against the SCXML schema.

Transitions Property

Use this property to add additional outputs (transitions) using the block's custom Transitions dialog.

1. Click opposite **Transitions** under **Value**. This brings up the  button.
2. Click the  button to bring up the Configure Transitions dialog box.
3. Click **Add**. The dialog box now appears as shown below.

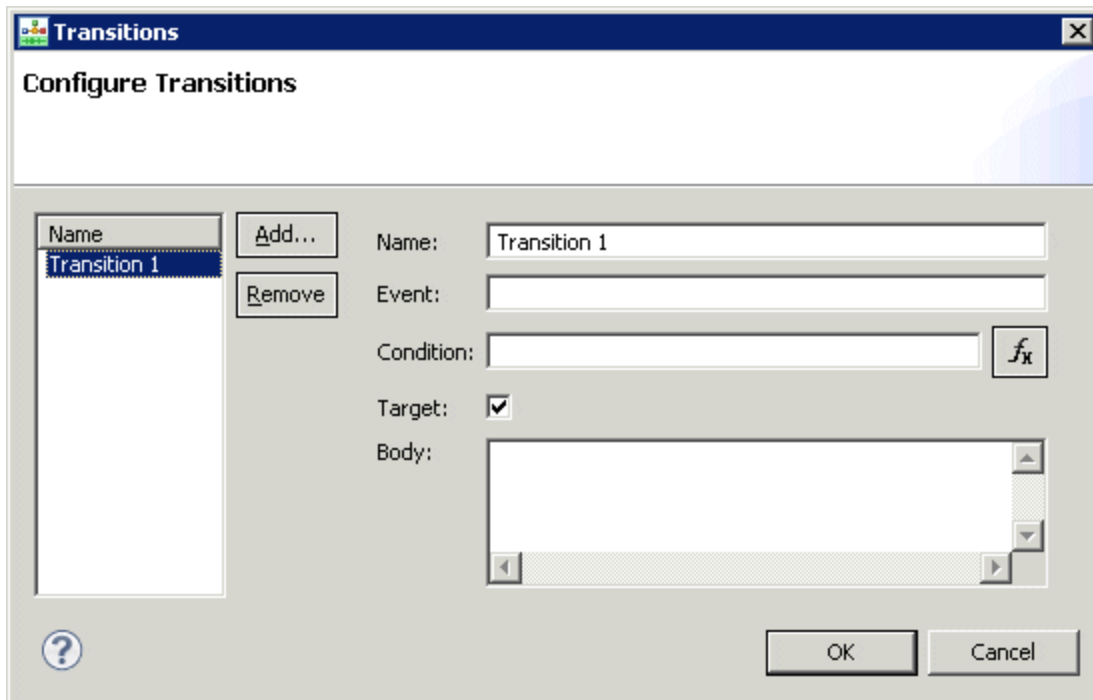

4. For each transition, specify at least one name, event, condition, or target (you are not required to complete all three fields). An output port is created for every transition

- **Name**--Composer uses the name of the transition to label the output.
- **Event**--Use to select the event that will trigger this transition.
- **Condition**--The guard condition for this transition. The transition is selected only if the condition evaluates to true.
- **Target**--If true, an output port is created and the user can connect it to the block this transition will transition to when it is executed. If false, the transition will not cause a change in the state configuration when it is executed. The executable content contained in the transition will still be executed, so the transition will function as a simple event handler.

If a target is set, an output port for that transition will appear and you can connect it to other blocks. If a target is not set, an output port for that transition does not appear; in this case, you can add some SCXML code to handle the event. When through in the dialog box, click **OK**.

Condition Property

Find this property's details under [Common Properties](#).

Logging Details Property

Find this property's details under [Common Properties](#).

Log Level Property

Find this property's details under [Common Properties](#).

Enable Status Property

Find this property's details under [Common Properties](#).

Using the SCXML State Block

The sample below demonstrates one way of using the SCXML State block to:

1. Register an Agent-DN (Needed in order to send a Logoff request)
2. Logoff Request for an Agent
3. Unregister the Agent-DN

Below is an example diagram using the SCXML State block and example code. If you do not have the Agent information, retrieve it from the Configuration Database with `FindCfgObjURS`. Register the Agent, make the Agent not ready, and then log out the Agent, all using the URS `trek` function. The details of this function can be found by the `http` request—for example:

```
http://< urs host>:< urs http port>/urs/help/misc/trek
```

where the `http port` is defined in the URS options section `http`. Also you must enable this method by setting `methods to all` in the same section.

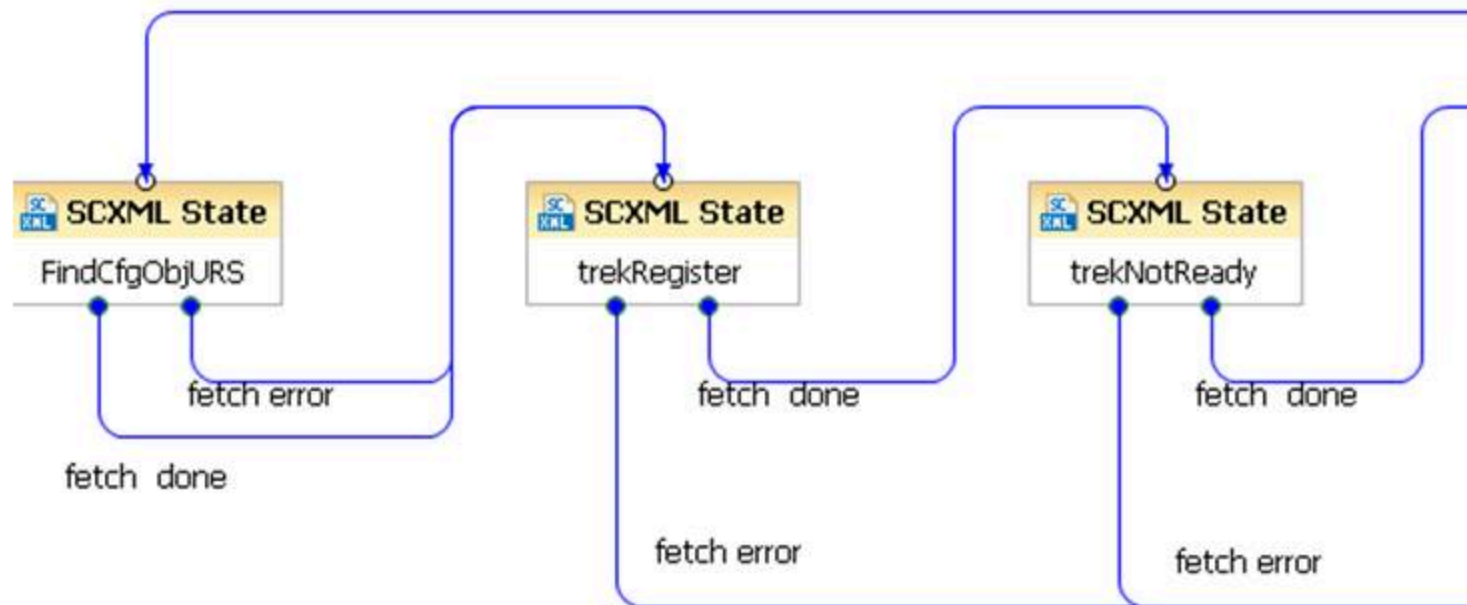

For this example, create the following Project variable: vursFetchReqID.

[+] Restrictions, Disclaimer and Copyright Notice

Any authorized distribution of any copy of this code (including any related documentation) must reproduce the following restrictions, disclaimer and copyright notice:

The Genesys name, the trademarks and/or logo(s) of Genesys shall not be used to name (even as a part of another name), endorse and/or promote products derived from this code without prior written permission from Genesys Telecommunications Laboratories, Inc.

The use, copy, and/or distribution of this code is subject to the terms of the Genesys Developer License Agreement. This code shall not be used, copied, and/or distributed under any other license agreement.

THIS CODE IS PROVIDED BY GENESYS TELECOMMUNICATIONS LABORATORIES, INC. ("GENESYS") "AS IS" WITHOUT ANY WARRANTY OF ANY KIND. GENESYS HEREBY DISCLAIMS ALL EXPRESS, IMPLIED, OR STATUTORY CONDITIONS, REPRESENTATIONS AND WARRANTIES WITH RESPECT TO THIS CODE (OR ANY PART THEREOF), INCLUDING, BUT NOT LIMITED TO, IMPLIED WARRANTIES OF MERCHANTABILITY, FITNESS FOR A PARTICULAR PURPOSE OR NON-INFRINGEMENT. GENESYS AND ITS SUPPLIERS SHALL NOT BE LIABLE FOR ANY DAMAGE SUFFERED AS A RESULT OF USING THIS CODE. IN NO EVENT SHALL GENESYS AND ITS SUPPLIERS BE LIABLE FOR ANY DIRECT, INDIRECT, CONSEQUENTIAL, ECONOMIC, INCIDENTAL, OR SPECIAL DAMAGES (INCLUDING, BUT NOT LIMITED TO, ANY LOST REVENUES OR PROFITS).

Copyright © 2008—2016 Genesys Telecommunications Laboratories, Inc. All rights reserved.

[+] Example SCXML Code

```

<onentry>
    <script>
        var KVPs = 'number:' + '704' + '|tenant:' + system.TenantName +
'|switch:' + _genesys.ixn.interactions[system.InteractionID].location.media_server;
        var vLocalParms = [2, KVPs ];
        var ursFunc = 'urs/call/' +
_genesys.ixn.interactions[system.InteractionID].voice.connid + '/func/FindConfigObject';
    </script>
    <session:fetch requestid="vursFetchReqID" srcexpr="ursFunc" method="'urs'">
        <param name= "params" expr="uneval(vLocalParms)" />
    </session:fetch>
</onentry>

```

Transitions:

```

Event:          session.fetch.done
Condition:      _event.data.requestid == vursFetchReqID
Body: ( if you want the data to be in JSON form )

```

```

var vEventData = _event.data.content.toString();
vEventData = vEventData.replace(/[/]/g, "");
vEventData = vEventData.replace(/\\u000a/g, "");
vEventContent = JSON.parse(vEventData);

```

Results will be:

```

vEventContent =
{
    dbid:159,
    type:1,
    number:"704",
    name:"",
    switchdbid:103,
    switch:"SipSwitch",
    tenantdbid:101,
    tenant:"orchestration",
    annex:{TServer:["true"]}
}

```

```

Event:          error.session.fetch
Condition:      _event.data.requestid == vursFetchReqID
Body: ( whatever you want to do if an error happens )

```

trekRegister:

```

<onentry>
    <script>
        var ursFunc = 'urs/trek/exec';
    </script>
    <session:fetch requestid="vursFetchReqID" srcexpr="ursFunc" method="'urs'">
        <param name= "switch" expr="'SipSwitch'"/>
        <param name= "thisdn" expr="'704'"/>
        <param name= "event" expr="'RequestRegisterAddress'"/>
    </session:fetch>
</onentry>

```

Transitions:

```
Event:          session.fetch.done
Condition:      _event.data.requestid == vursFetchReqID
Body: ( if you want the TEvent data to be in JSON form )
```

```
    var vEventData = _event.data.content.toString();
    vEventData = vEventData.replace(/[/]/g, ",");
    vEventData = vEventData.replace(/\\u000a/g, "");
    vEventContent = JSON.parse(vEventData);
```

Results will be:

```
vEventContent =
{
    event:"EventRegistered",
    AddressType:1,
    AddressInfoType:8,
    AddressInfoStatus:1,
    AgentID:"704",
    ThisDN:"704",
    AgentWorkMode:0,
    ReferenceID:53,
    TimeinSecs:1461257507,
    TimeinuSecs:61000,
    return:"ok",
    Extensions:
    {
        AgentStatus:2,
        AgentStatusTimestamp:1461257264,
        AgentStatusReliability:0,
        AgentLoginTimestamp:1461257264,
        AgentLoginReliability:0,
        AgentSessionID:"7MQNHM3BJ15RN2NS1ABJKTUT0K00006G",
        AgentWorkMode:0,
        status:0,
        EmulateLogin:"true"
    }
}
```

Event error.session.fetch – handled as in first example.

trekNotReady:

```
<onentry>
    <script>
        var ursFunc = 'urs/trek/exec';
    </script>
    <session:fetch requestid="vursFetchReqID" srcexpr="ursFunc" method="'urs'">
        <param name= "switch" expr="'SipSwitch'"/>
        <param name= "thisdn" expr="'704'"/>
        <param name= "event" expr="'RequestAgentNotReady'"/>
    </session:fetch>
</onentry>
```

trekLogout:

```
<onentry>
    <script>
        var ursFunc = 'urs/trek/exec';
    </script>
    <session:fetch requestid="vursFetchReqID" srcexpr="ursFunc" method="'urs'">
        <param name= "switch" expr="'SipSwitch'"/>
        <param name= "thisdn" expr="'704'"/>
        <param name= "event" expr="'RequestAgentLogout'"/>
    </session:fetch>
</onentry>
```

```
    </session:fetch>  
</onentry>
```

Subroutine Block

Use the Subroutine block to create reusable sub-modules (sub-workflows). You can invoke external SCXML documents or use a sub-workflow created using Composer. The input and output parameter names will be automatically picked from the sub-workflow created by Composer. Composer supports passing variables between a workflow and sub-workflow.

Also see [Using Composer Shared Subroutines](#).

Important

Starting with Composer 8.1.3 versions, the callflow diagram Subdialog block and the workflow diagram Subroutine block use absolute paths with the Project name to refer to the location of the selected resource in the Workspace, e.g., `workspace:///WFM/Workflows/subroutine.workflow`. Renaming or copying Projects requires a manual update to change the Project name in the Subroutine and Subdialog blocks.

Creating a Subroutine Using A Sub-Workflow

1. Create the main workflow diagram file using **New > Other > Composer > Workflow diagram > Main Workflow**.
2. After designing the main workflow diagram, create the sub-workflow diagram using **New > Other > Composer > Workflow diagram > Sub-Workflow**.
3. In the Entry Block of the sub-workflow diagram, enter the parameters, which will be passed as input from the main to the sub-workflow diagram.

Variable Name	Type	Value	Description
App_Language	System	en-US	Application Language
CallID	System	_genesys.ixn.interactions[0].voice.callid	callid created by the switch
DNIS	System	_genesys.ixn.interactions[0].voice.dnis	DNIS associated with Call...
ANI	System	_genesys.ixn.interactions[0].voice.ani	ANI associated with the c...
App_Last_Error	System	undefined	Last error
App_Last_Error_Description	System	undefined	Last error description
_COMPOSER_WSSTUBBING	User	0	Flag to control WebServic...
Input1	Input	Enter Value	Enter Description

4. Design the sub-workflow diagram.

5. In the Exit block of the sub-workflow diagram, select the variables, which will be returned back to the called main diagram.

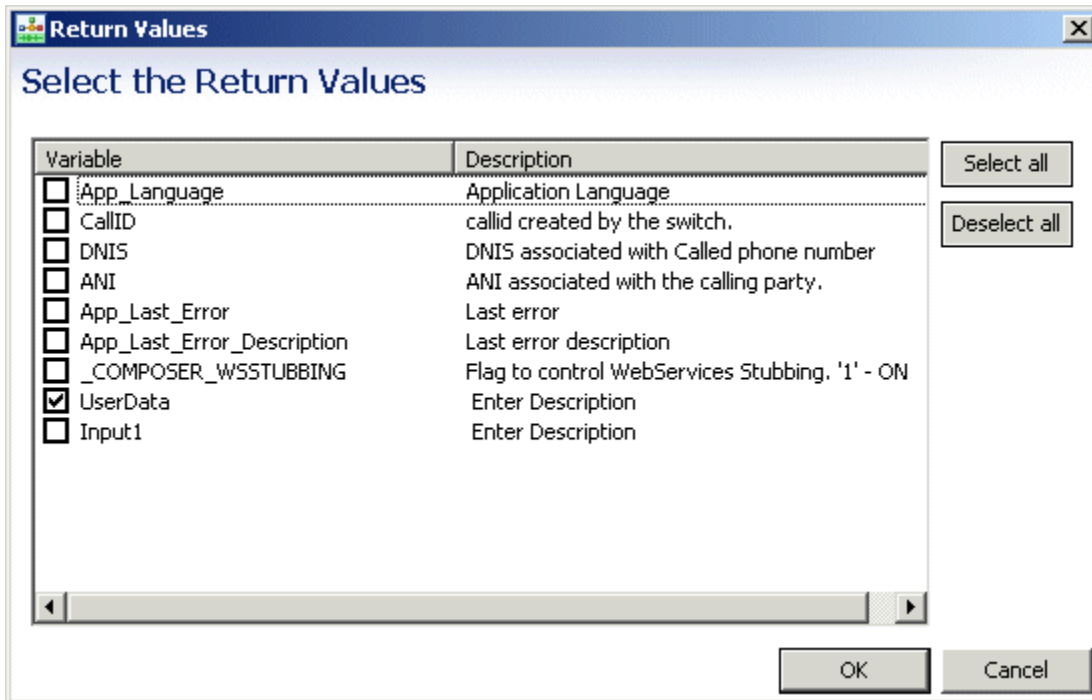

6. In the main diagram, use the Subroutine Block to call the newly created sub-workflow and the input and output parameters. For input/output synchronization, use the Uri property of the Subroutine block to select the sub-workflow diagram.

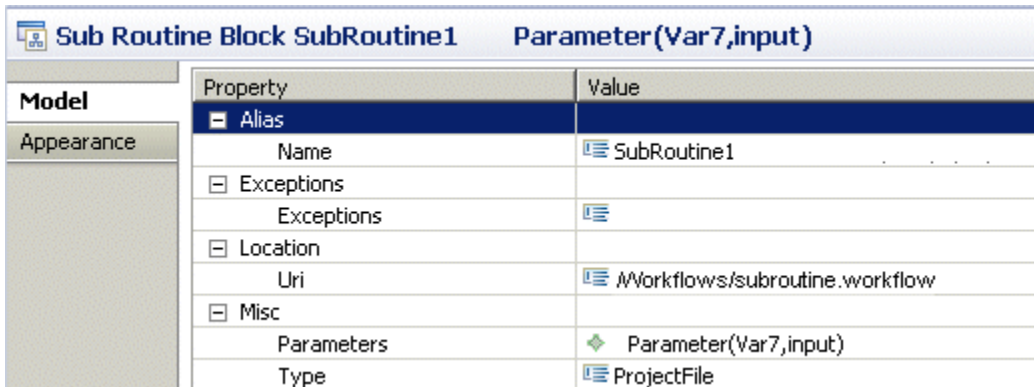

Now the Parameters property can be used for the Parameter Synchronization. The main diagram implicitly parses the sub-workflow parameters and lists them in the Parameter settings dialog as shown below.

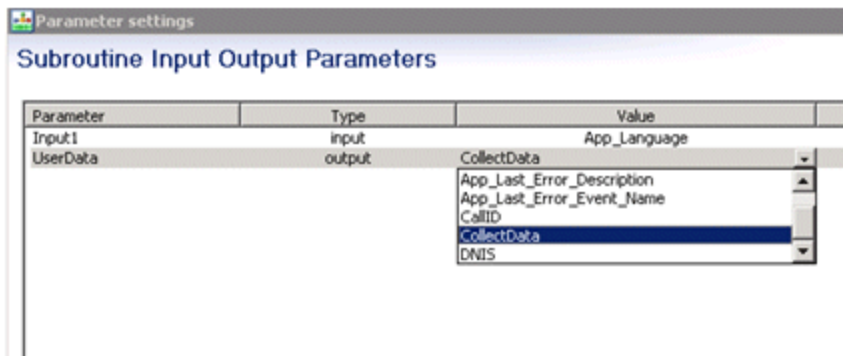

7. Define the value for the input type variables and collect the returning output type variables in a variable.

The Subroutine block has the following properties:

Name Property

Find this property's details under [Common Properties](#).

Block Notes Property

Find this property's details under [Common Properties](#).

Exceptions Property

Find this property's details under [Common Properties](#).

Uri Property

The Uri property specifies the destination (URL or Composer Project) depending on the value of the Type property. To set a URL destination for the Uri property (**Type** property is set to **URL**):

1. Select the **Uri** row in the block's property table.
2. In the **Value** field, type a valid URL. Variables should not be selected as all subroutines are fetched by Orchestration Server before it starts executing the application at which time variables do not exist.

To set a Project destination for the Uri property (**Type** property is set to ProjectFile):

1. Click the **Uri** row in the block's property table.

2. Click the  button to open the Uri dialog box.
3. Select a workflow in the list.
4. Click **OK** to close the dialog box.

Type Property

The Type property sets the type of the invoked subroutine. There are two options:

- **URL**--The invoked sub-workflow can be found at the location specified in the Uri property.
- **ProjectFile**--The invoked sub-workflow is another workflow in the Project.

To select a value for the Type property:

1. Select the **Type** row in the block's property table.
2. In the **Value** field, select URL or ProjectFile from the drop-down list.

Condition Property

Find this property's details under [Common Properties](#).

Logging Details Property

Find this property's details under [Common Properties](#).

Log Level Property

Find this property's details under [Common Properties](#).

Enable Status Property

Find this property's details under [Common Properties](#).

Parameters Property

Use the Parameters property to specify parameters to pass to the invoked sub-workflow. To specify

parameters: The URI field must contain a value.

1. Click the **Parameters** row under **Value**.
2. Click the  button to open the Subroutine Input Output Parameters dialog box.
3. Click the **Add** button to enter parameter details.
4. In the **Parameter** field, accept the default name or change it.
5. From the **Type** drop-down list, select input, output, or inout:

input	Input parameters are variables submitted to the sub-workflow.
output	Output parameters are variables that the sub-workflow returns and will be reassigned back to the current workflow.
input/output	Inout parameters are parameters that act as both input and output.

6. In the **Expression** drop-down list, select from among the variables shown, type your own expression, or click the  button to use **Expression Builder**.
7. In the **Description** field, type a description for this parameter.
8. Click **Add** again to enter another parameter, or click **OK** to finish.

ORS Extensions Property

Starting with 8.1.4, Composer blocks used to build routing applications (with the exception of the Disconnect and EndParallel blocks) add a new **ORS Extensions** property.

User Data Block

You can use in a routing application to update an interaction's **User Data** and for attaching Business Attributes, Categories and Skills. Corresponds to function `_genesys.ixn.setUserData` under Functions in the *Orchestration Developer's Guide* and available in **Expression Builder**. This block generates ECMAScript inside an SCXML state and does not rely on **External Service Protocol** via `<session:fetch>`. For manually attaching categories to an interaction, the User Data block can be used and then a **Branching block** can be (optionally) used to segment interactions to different logical branches based on the different categories. Important! **See Mandatory User Data For UCS Blocks.**

Important Notes

- Do not assign the value of a variable named data to a key-value pair. This will not work since the generated code also declares a variable named data.
- When the Wait for Event property is set to true and User Data blocks are used in both the parallel legs, use **Internal Key Prefix** to reliably verify the user data attachment.

The User Data block has the following properties:

Name Property

Find this property's details under **Common Properties**.

Block Notes Property

Find this property's details under **Common Properties**.

Assign Data Property

This property specifies one or more key-value pairs to add to the interaction's User Data. To specify key-value pairs, click in the Value column to display the  button and click it to bring up the dialog. Data from various sources can be attached as well as free form key value pairs can be specified (Default). However, **note that only one category can be used in a block. Switching categories will erase previously specified values.**

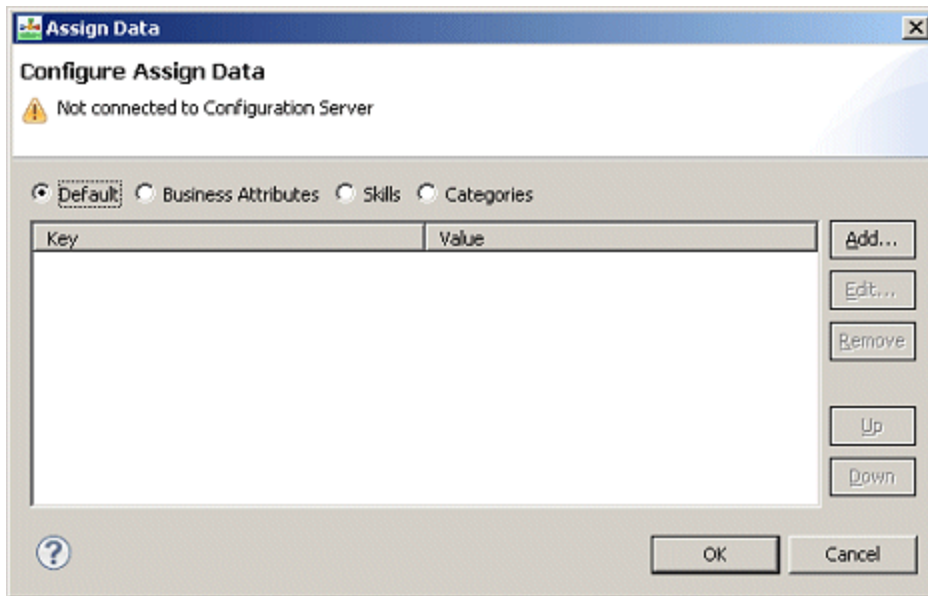

UserData1.gif

1. **Default** This option can be used to specify both the key name and the key value as literals or variables.

Note: In case the key or value contains special characters that may require encoding e.g. '<', '-', or quotes, define a variable and set its value to this literal and use the variable as the value.

2. **Business Attributes** This picks up specific business attributes and if connected to Configuration Server, shows a list of values configured for these attributes.
3. **Skills** One or more skills can be specified. If connected to Configuration Server, a list of skills is shown.
4. **Categories** This option requires an active connection to **Configuration Server** and supports attaching categories defined in Configuration Server as well as **Relevancy** for the category. **Relevancy** is a number from 1 to 100 that reflects the minimum relevance percentage that each classification category must have in order for **Classification Server** to consider an interaction as belonging to that category.

Click the Add button to add a key-value pair of the selected type. When done, click Ok to dismiss the dialog and Save the diagram.

Condition Property

Find this property's details under **Common Properties**.

Logging Details Property

Find this property's details under **Common Properties**.

Exceptions Property

Find this property's details under [Common Properties](#).

Interaction ID Property

Set to a meaningful value or keep the default value, which is the system variable `InteractionId`. Can be used for "interaction-less" processing for scenarios where the `InteractionId` variable is not automatically initialized, but instead must wait for an event. An example would be an SCXML application triggered by a Web Service that does not add an interaction. **Background:** Previous to 8.1.1, Composer did not expose an `InteractionId` property. Instead, when ORS started processing an interaction, a generated SCXML application automatically initialized the system variable, `InteractionId`. This variable was then used internally by Routing and certain eServices blocks when interacting with ORS. With the introduction of support for Interaction-less processing, you can now define a specific event to initialize `InteractionId`, or not define an event at all. For scenarios with an interaction (IPD Diagram/`Wait For Event=interaction.present` for example), you may keep the default value for the Interaction ID property. The default value is the system variable `InteractionId`, which is initialized automatically in this case. For other scenarios (any scenario where the system variable `InteractionId` is not set), you may choose to:

1. Not use blocks that require an Interaction ID
2. And/or set the Interaction ID property to a meaningful value
3. And/or assign a meaningful value to the `InteractionId` system variable

Log Level Property

Find this property's details under [Common Properties](#).

Enable Status Property

Find this property's details under [Common Properties](#).

ORS Extensions Property

Starting with 8.1.4, Composer blocks used to build routing applications (with the exception of the `Disconnect` and `EndParallel` blocks) add a new [ORS Extensions](#) property.

Internal Key Prefix

Starting with 8.1.420.14, Composer attaches an internal key along with the configured user data. When the Wait for Event property is set to true and User Data blocks are used in both parallel legs, use Internal Key Prefix (the **Show Advanced Properties** button) to reliably verify the user data attachment. The value of the internal key is the time stamp of the application change. This key is used internally to verify whether the `interaction.udata.changed` event has been received. If parallel User Data blocks are used in a workflow, the internal keys might mismatch, which leads to a timeout of User Data blocks. You can configure the internal key prefix either directly through this property or through variables. The configured value will be attached as a prefix to the existing Composer-generated internal key; for example:

```
Composer_<Internal Key Prefix>_internal_key = <timestamp>
```

Important

Use the Internal Key Prefix only when setting user data from two parallel legs and waiting for confirmation in both legs.

Wait For Event Property

This property allows you to choose whether to wait for the user data changed event before transitioning to the next block.

1. Click **Wait for Event** under **Property**.
2. Under **Value**, select one of the following:
 - **True**
 - **False**

Timeout Property

Select the variable that contains the timeout value for the user data change event. This property supports the following:

- Literal integer value. For example: `Timeout=4 & Unit=second <send event="'WaitEvent1.wait.timeout'" delay="'4s'"/>`.
- Variable with integer value. For example: `Timeout=Variable(4) & Unit=second <send event="'WaitEvent1.wait.timeout'" delay="'4s'"/>`.
- Variable with string value. For example: `Timeout=Variable('6') & Unit=second <send event="'WaitEvent1.wait.timeout'" delay="'6s'"/>`.
- Variable with string value including unit. For example: `Timeout=Variable('6ms') & Unit=second <send event="'WaitEvent1.wait.timeout'" delay="'6ms'"/>`. In this case, the unit specified in the

variable is used instead of the static property unit.

Wait Event Block

Use to have ORS transition out when one of the defined events is received and the associated condition is true. The Wait block has the following properties:

Name Property

Find this property's details under [Common Properties](#).

Block Notes Property



Find this property's details under [Common Properties](#).

Event Property

Enter a value or select the variable that contains the data associated with the event that makes ORS transition out.

Transitions Property

Use this property to define the events/condition pairs that makes ORS transition out. ORS does not need all the events in the list to occur in order to transition out, but only one of them. The condition is optional. If not set, it behaves as if condition was true (ORS transitions out of the block). To specify events/condition pairs:

1. Click the **Transitions** row in the block's property table.
2. Click the  button to open the Configure Transitions dialog box.
3. Click **Add** to add an entry.
4. Enter the Event.
5. Click under **Conditions**.
6. Click the  button to use [Expression Builder](#) to define the conditions.

Condition Property

Find this property's details under [Common Properties](#).

Logging Details Property

Find this property's details under [Common Properties](#).

Log Level Property

Find this property's details under [Common Properties](#).

Enable Status Property

Find this property's details under [Common Properties](#).

Timeout Property

Select the variable that contains the timeout value or keep the default of 30 (added in 8.1.440.18). If the timeout expires before one of the targets is available, the interaction is routed to the error port (if the Exception property is configured for the block). This property supports the following:

- Literal integer value. For example: `Timeout=4 & Unit=second <send event='WaitEvent1.wait.timeout' delay='4s' />`.
- Variable with integer value. For example: `Timeout=Variable(4) & Unit=second <send event='WaitEvent1.wait.timeout' delay='4s' />`.
- Variable with string value. For example: `Timeout=Variable('6') & Unit=second <send event='WaitEvent1.wait.timeout' delay='6s' />`.
- Variable with string value including unit. For example: `Timeout=Variable('6ms') & Unit=second <send event='WaitEvent1.wait.timeout' delay='6ms' />`. In this case, the unit specified in the variable is used instead of the static property unit.

Unit Property

Select the unit of measure for the timeout.

ORS Extensions Property

Starting with 8.1.4, Composer blocks used to build routing applications (with the exception of the Disconnect and EndParallel blocks) add a new **ORS Extensions** property.

Routing Blocks

The table below summarizes the Routing blocks.

Cancel	Removes a route request from a queue and from target consideration.
Default Route	Instructs URS to route a voice interaction to the default destination.
Queue Interaction	Places an a non-voice interaction into an existing queue.
Force Route	Force Universal Routing Server to route the interaction to the first target type without any other operations.
Query	Queries the status of a route request.
Single Step Transfer	Use this block for both voice and multimedia interactions to force Universal Routing Server (URS) to route the interaction to the first target type (ACD Queue, Destination Label, or Routing Point) without any other operations.
Route Interaction	Routes a non-voice interaction to one or more target objects.
Routing Rule	Selects routing rules that currently exist in the Configuration Database, such as those created with Interaction Routing Designer.
Stop Interaction	Requests Interaction Server to stop processing an interaction.
Target	Routes a voice interaction to a target. Can be used for percentage and/or conditional routing using threshold expressions.
Update	Updates the criteria associated with an outstanding submit request.
Ideal Agent Block	Routes to the most ideal agent to handle an interaction when more than one is available.

Also see:

- [Percent and Conditional Routing](#)
- [Statistics Manager and Builder](#).

Cancel Block

Use the Cancel block to remove a route request from a queue and from target consideration. Can be used for both voice and multimedia interactions. For more information, see the *Orchestration Server Developer's Guide*, Queue Interface, [Action Elements](#), <cancel> Action Element.

Name Property

Find this property's details under [Common Properties](#).

Block Notes Property

Find this property's details under [Common Properties](#).

Condition Property

Find this property's details under [Common Properties](#).

Enable Status Property

Find this property's details under [Common Properties](#).

Logging Details Property

Find this property's details under [Common Properties](#).

Log Level Property

Find this property's details under [Common Properties](#).

Interaction ID Property

Set to a meaningful value or keep the default value, which is the system variable `system.ANI`. If the queue is present, then all outstanding requests are cleared from the defined queue. The `interactionid` attribute is only used in conjunction with the queue attribute and is only needed when your application is handling multiple interactions. For more information, see the *Orchestration Server Developer's Guide*, Queue Interface, [Action Elements](#), `<cancel>` Action Element, `Interactionid`.

Request ID Property

Specify either:

- a variable holding the request ID of an outstanding queuing request;
- or a Target/Route Interaction block (Block Reference)

Queue Property

Optional. To specify a queue:

1. Click under **Value** to display the  button.
2. Click **Add** to open the Configure Queue dialog box. Do one of the following:
 - If you are [connected to Configuration Server](#), select **Configuration Server**. Select the queue from the **Value** field. This is the queue containing the route request to be cancelled. Queues listed here were previously defined with the [Interaction Queue](#) block.
 - Select **Literal** and enter the name of the queue in the Value field.
 - Select **Variable** and select the variable that contains the value.
3. Click **OK**.

ORS Extensions Property

Starting with 8.1.4, Composer blocks used to build routing applications (with the exception of the Disconnect and EndParallel blocks) add a new [ORS Extensions](#) property.

Default Routing Block

Instructs URS to route the interaction to the default destination, as specified by the default DNs at the Routing Point or by the URS configuration option `default_destination`. When you use the Default Route block in a strategy, it sends the interaction to that destination. Once set this will be applicable for the entire duration of the strategy unless overridden by a **Default Routing** block in the workflow execution.

The Default Route block has the following properties:

Name Property

Find this property's details under [Common Properties](#).

Block Notes Property

Find this property's details under [Common Properties](#).

Exceptions Property

Find this property's details under [Common Properties](#).

Hints Property

This property is for future use by Orchestration Server. Its use will be described in various action elements referenced in the Orchestration Server wiki.

Interaction ID Property

Set to a meaningful value or keep the default value, which is the system variable `InteractionId`.

Can be used for **interaction-less processing** for scenarios where the `InteractionId` variable is not automatically initialized, but instead must wait for an event. An example would be an SCXML application triggered by a Web Service that does not add an interaction.

Background: Previous to 8.1.1, Composer did not expose an Interaction ID property. Instead, when ORS started processing an interaction, a generated SCXML application automatically initialized the

system variable, InteractionId. This variable was then used internally by Routing and certain eServices blocks when interacting with ORS.

With the introduction of support for Interaction-less processing, you can now define a specific event (IPD Diagram Wait_For_Event_Property) to initialize InteractionId, or not define an event at all.

For scenarios with an interaction (IPD Diagram/Wait For Event=interaction.present for example), you may keep the default value for the Interaction ID property. The default value is the system variable InteractionId, which is initialized automatically in this case.

For other scenarios (any scenario where the system variable InteractionId is not set), you may choose to:

1. Not use blocks that require an Interaction ID.
2. And/or set the Interaction ID property to a meaningful value.
3. And/or assign a meaningful value to the InteractionId system variable.

Detach Property

Controls whether the Orchestration Platform should <detach> an interaction from the current session before routing to the specified targets. When this property is set to true, the interaction is detached from the current session.

Note: A Project properties option, **Interaction Detach**, in the Orchestration Options dialog can generate the detach attribute in the <ixn:redirect> tag in the Routing blocks. See [Detaching Interactions from Sessions](#).

Detach Timeout Property

Use to specify how long to attempt to <detach> if an initial attempt fails with an invalidstate error. Specify the timeout in milliseconds. If set to 0, no further attempt to detach is made. After the timeout, if the <detach> is not successful, no further attempts will be made and the block will attempt to reclaim the interaction back into the current session using <attach>.

Condition Property

Find this property's details under [Common Properties](#).

Logging Details Property

Find this property's details under [Common Properties](#).

Log Level Property

Find this property's details under [Common Properties](#).

Enable Status Property

Find this property's details under [Common Properties](#).

Pass Context Property

This property accepts true/false values. When set to true and Detach is also true:

- URL built with the block name is stored into this interaction's user data (user data key name is '_composer_originating_session') just before detaching the interaction. That URL will be used by the orchestration destination session (that is the new orchestration session started to handle the interaction after it was redirected to an other routing point) to request the context of the originating session. After the processing for this block is over, the originating session is blocked until the destination session actually reads the context. The context consists of the system and user [variables](#).

ORS Extensions Property

Starting with 8.1.4, Composer blocks used to build routing applications (with the exception of the Disconnect and EndParallel blocks) add a new [ORS Extensions](#) property.

Force Route Block

Use this block for both voice and multimedia interactions to force Universal Routing Server (URS) to route the interaction to the first target type (ACD Queue, Destination Label, or Routing Point) without any other operations. The interaction is then routed unconditionally, i.e., URS does not check the status of the destination. Warning! Force should always be thought of as a last plan of action and therefore used infrequently. The Force Route block has the following properties:

Name Property

Find this property's details under [Common Properties](#).

Block Notes Property

Find this property's details under [Common Properties](#).

Destination Property

Use this property to specify the forced routing destination. The property also supports specifying a Resource type, which allows you to specify key-values. Find this property's details under [Common Properties](#).

Exceptions Property

Find this property's details under [Common Properties](#).

From Property

A value expression, which returns the address that this interaction is to be redirected from. Set this property to the variable DNIS for voice interactions, or to the variable InteractionID for multimedia interactions. Composer will automatically set this property to DNIS or to InteractionID when the Destination property is set (respectively) to a Target Block or to a Route Interaction block. When the Destination property is not assigned a Block Reference value, you must select the appropriate From value.

1. Click under Value to display the  button.

2. Click the  button to open the From dialog box.
3. Select one of the following:

- **Literal.** For Value, you can specify:
 - An agent: <agent id>
 - A place: <place id>
 - A DN: <number>
 - An e-mail address: <username>@<host> or _origin or _origin.all or _udata
 - A customer number: <dn number>
 - A target format addresses: <Target DN>

See the [Orchestration Server Documentation Wiki](#) for those literals that apply to multimedia interactions only.

- **Variable.** If the variable contains a string, see Literal above. If the value is a JSON object, Value can refer to:
 - An agent: {agent: <agent id>, type:A}
 - An agent group: {agent: <name>, type:AG}
 - A place: {place: <place id>, type:AP}
 - A place group: {place: <name>, type:PG}
 - A DN: {dn: <number>, type:Q or RP or DN, switch:<switch name>}
 - An interaction queue: {id: <q name>, type:iq }
 - A workbin: {id: <wb name>, type:wb<owner>}
 - A customer number: {dn: <number>}
 - A target format addresses: Resource object from the queue.submit.done event (the Target Block [Resource Selected property](#)).

See the [Orchestration Server Documentation Wiki](#) for those literals that apply to multimedia interactions only.

- **Configuration Server** to select the from Switch//DN if [connected](#).
- **Resource** to select a resource using properties that will form a JSON object.

See the [Orchestration Server Documentation Wiki](#).

4. Click **OK** to close the From dialog box.

Condition Property

Find this property's details under [Common Properties](#).

Logging Details Property

Find this property's details under [Common Properties](#).

Log Level Property

Find this property's details under [Common Properties](#).

Interaction ID Property

Set to a meaningful value or keep the default value, which is the system variable InteractionId. Can be used for **interaction-less processing** for scenarios where the InteractionId variable is not automatically initialized, but instead must wait for an event. An example would be an SCXML application triggered by a Web Service that does not add an interaction. **Background:** Previous to 8.1.1, Composer did not expose an Interaction ID property. Instead, when ORS started processing an interaction, a generated SCXML application automatically initialized the system variable, InteractionId. This variable was then used internally by Routing and certain eServices blocks when interacting with ORS. With the introduction of support for Interaction-less processing, you can now define a specific event **IPD Wait_For_Event** property to initialize InteractionId, or not define an event at all. For scenarios with an interaction (IPD Diagram/Wait For Event=interaction.present for example), you may keep the default value for the Interaction ID property. The default value is the system variable InteractionId, which is initialized automatically in this case. For other scenarios (any scenario where the system variable InteractionId is not set), you may choose to:

1. Not use blocks that require an Interaction ID
2. And/or set the Interaction ID property to a meaningful value
3. And/or assign a meaningful value to the InteractionId system variable

Hints Property

This property is for future use by Orchestration Server. Its use will be described in various action elements reference in the Orchestration Server wiki.

Detach Property

Controls whether the Orchestration Platform should <detach> an interaction from the current session before routing to the specified targets. When this property is set to true, the interaction is detached from the current session.

Note: A Project properties option, **Interaction Detach**, in the Orchestration Options dialog can generate the detach attribute in the <ixn:redirect> tag in the Routing blocks. See [Detaching Interactions from Sessions](#).

Detach Timeout Property

Use to specify how long to attempt to <detach> if an initial attempt fails with an invalidstate error. Specify the timeout in milliseconds. If set to 0, no further attempt to detach is made. After the timeout, if the <detach> is not successful, no further attempts will be made and the block will attempt to reclaim the interaction back into the current session using <attach>.

Type Property

Use to define the type of redirection processing that is to be done. For more information and individual values, see the [Orchestration Server Documentation Wiki](#).

Enable Status Property

Find this property's details under [Common Properties](#).

Pass Context Property

This property accepts true/false values. When set to true and Detach is also true:

- URL built with the block name is stored into this interaction's user data (user data key name is '_composer_originating_session') just before detaching the interaction. That URL will be used by the orchestration destination session (that is the new orchestration session started to handle the interaction after it was redirected to an other routing point) to request the context of the originating session. After the processing for this block is over, the originating session is blocked until the destination session actually reads the context. The context consists of the system and user [variables](#).

ORS Extensions Property

Starting with 8.1.4, Composer blocks used to build routing applications (with the exception of the Disconnect and EndParallel blocks) add a new **ORS Extensions** property.

Force Routing to an External Number

Scenario: When force routing and doing a single-step consult to a routing point, where an external is dialed.

If you get these error messages:

```
expr='Error message: Cannot get link and/or device from call'. 'invalid source'
```

Check that the `system.ThisDN` variable has the right value when it reaches the Force Route block.

Queue Interaction Block

Use this block to place a multimedia (non-voice) interaction into an existing queue created with the [Interaction Queue](#) block. The generated SCXML code instructs Universal Routing Server to request Interaction Server to move the current interaction into the specified queue. You can select an existing interaction queue from within this block or specify a variable that contains the name of an interaction queue. You can also send an interaction to a queue in another IPD within the same Project. The selected interaction queue appears as a [Queue Reference block](#) in the [interaction process diagram](#). Important Note! Each interaction path in a workflow for multimedia interactions should end with one of these blocks: [Stop Interaction](#), [Queue Interaction](#), or [Route Interaction](#). Also see information on the [App Terminate Ixn On Exit](#) variable.

Use Case

The logic of a routing workflow may determine some attributes of an interaction, such as by looking at the Subject line of an inbound e-mail, and then use different interaction queues as a method of segmenting these different types of interactions. You could use the [Branching block](#) for this purpose. The Queue Interaction block has the following properties:

Name Property

Find this property's details under [Common Properties](#).

Block Notes Property

Find this property's details under [Common Properties](#).

Exceptions Property

Find this property's details under [Common Properties](#).

Condition Property

Find this property's details under [Common Properties](#).

Logging Details Property

Find this property's details under [Common Properties](#).

Log Level Property

Find this property's details under [Common Properties](#).

Enable Status Property

Find this property's details under [Common Properties](#).

Interaction Queue Name Property

Use this property to specify the queue where the interaction is to be placed.

1. Click under Value to display the  button.
2. Click the button to open the Interaction Queue dialog box. Your dialog box may include existing IRD business processes with associated interaction queues underneath.
3. Select an interaction queue to which the incoming interaction has to be sent.
4. Click OK.

Starting with Release 8.1.410.14, you can use a queue defined in referenced Projects. For more information, see [AddingQueues](#).

Starting with Release 8.1.440.18, the Interaction Queue property supports selecting a queue dynamically through a variable. The selected variable will be used in the generated code in the destQueue variable 'id' option. Example:

```
<state id="_reserved_QueueInteraction1_redirect">
    <onentry>
        <script>
            var destQueue = {'type':'IQ','id':var0};
        </script>
        <ixn:redirect detach="true"
requestid="App_QueueInteraction1['requestid']" interactionid="system.InteractionID"
from="system.InteractionID" to="destQueue"/>
    </onentry>
</state>
```

Interaction ID Property

Set to a meaningful value or keep the default value, which is the system variable InteractionId. Can be used for "interaction-less" processing for scenarios where the InteractionId variable is not automatically initialized, but instead must wait for an event. An example would be an SCXML application triggered by a Web Service that does not add an interaction. Background: Previous to 8.1.1, Composer did not expose an Interaction ID property. Instead, when ORS started processing an interaction, a generated SCXML application automatically initialized the system variable, InteractionId. This variable was then used internally by Routing and certain eServices blocks when interacting with ORS. With the introduction of support for Interaction-less processing, you can now define a specific event (IPD Diagram Wait For Event property) to initialize InteractionId, or not define an event at all. For scenarios with an interaction (IPD Diagram/Wait For Event=interaction.present for example), you may keep the default value for the Interaction ID property. The default value is the system variable InteractionId, which is initialized automatically in this case. For other scenarios (any scenario where the system variable InteractionId is not set), you may choose to:

1. Not use blocks that require an Interaction ID
2. And/or set the Interaction ID property to a meaningful value
3. And/or assign a meaningful value to the InteractionId system variable

Hints Property

This property is for future use by Orchestration Server. Its use will be described in various action elements reference in the Orchestration Server wiki.

Detach Property

Controls whether the Orchestration Platform should <detach> an interaction from the current session before queueing it. When this property is set to true, the interaction is detached from the current session.

Note: A Project properties option, **Interaction Detach**, in the Orchestration Options dialog can generate the detach attribute in the <ixn:redirect> tag in the Routing blocks. See [Detaching Interactions from Sessions](#).

Detach Timeout Property

Use to specify how long to attempt to <detach> if an initial attempt fails with an invalidstate error. Specify the timeout in milliseconds. If set to 0, no further attempt to detach is made. After the timeout, if the <detach> is not successful, no further attempts will be made and the block will attempt to reclaim the interaction back into the current session using <attach>.

Pass Context Property

This property accepts true/false values. When set to true and Detach is also true:

- URL built with the block name is stored into this interaction's user data (user data key name is '_composer_originating_session') just before detaching the interaction. That URL will be used by the orchestration destination session (that is the new orchestration session started to handle the interaction after it was redirected to an other routing point) to request the context of the originating session. After the processing for this block is over, the originating session is blocked until the destination session actually reads the context. The context consists of the system and user **variables**.

ORS Extensions Property

Starting with 8.1.4, Composer blocks used to build routing applications (with the exception of the Disconnect and EndParallel blocks) add a new **ORS Extensions** property.

Query Block

Use the Query block to query the status of a route request. Can be used for both voice and multimedia interactions. For more information, see the *Orchestration Server Developer's Guide*, Queue Interface, [Action Elements](#), <query> Action Element.

Name Property

Find this property's details under [Common Properties](#).

Block Notes Property

Find this property's details under [Common Properties](#).

Condition Property

Find this property's details under [Common Properties](#).

Enable Status Property

Find this property's details under [Common Properties](#).

Logging Details Property

Find this property's details under [Common Properties](#).

Log Level Property

Find this property's details under [Common Properties](#).

Request ID Property

Request ID is an input parameter. Specify either:

- a variable holding the request ID of an outstanding queuing request;
- or a Target/Route Interaction block (Block Reference)

Expected Wait Time Property

Select a variable to contain the expected wait for the route request. Also see:

- [Expected Wait Time](#)
- [Login Size](#)
- [Position in Queue](#)
- [Request ID](#)
- [Total Size](#)
- [Queue Poll Rate](#)

Login Size Property

Select the variable to contain the number of agents logged in currently targeted for the route request (you must have URS 8.1.3+). The selected variable will be populated with the respective output value obtained from the operations described in the [Expected Wait Time](#) property.

Position in Queue Property

Click the down arrow under Value and select the variable to contain the position that the route request currently has in the queue. The selected variable will be populated with the respective output value obtained from the operations described in the [Expected Wait Time](#) property.

Priority Property (Queue)

To use this optional property, click the down arrow under Value and select the variable, which contains a value expression returning the current priority of the route request in the queue. For more information, see <http://www.w3.org/TR/scxml/#ValueExpressions>.

Total Size Property

Select the variable to contain the total number of agents that could be targeted for the route request. The selected variable will be populated with the respective output value obtained from the operations described in the [Expected Wait Time_Property](#). You must have installed Universal Routing Server 8.1.3+.

ORS Extensions Property

Starting with 8.1.4, Composer blocks used to build routing applications (with the exception of the Disconnect and EndParallel blocks) add a new [ORS Extensions](#) property.

Route Interaction Block

Use this block to route a multimedia (non-voice) interaction to one or more target objects (use the [Target block](#) for voice interactions). You can also route to a target based on the value of a [Skill expression](#). An [interaction process diagram](#) associates routing targets with queues, either [interaction queues](#) or [virtual queues](#). When defining Route Interaction block properties, you have the option of selecting queues for both the existing interaction and a new outgoing interaction that may be created. You can also define a new interaction queue from within the block so you don't have to navigate away. Important Note! Each interaction path in a workflow for multimedia interactions should end with one of these blocks: [Stop Interaction](#), [Queue Interaction](#), or Route Interaction. Also see information on the [App Terminate Ixn On Exit](#) variable.

Use Case

- An inbound interaction hits a virtual route point, initiating a workflow routing strategy.
- The workflow strategy looks up data for the interaction in the customer database to determine the last agent who helped this customer and to determine the intent of the customer interaction.
- Next, the workflow sets priority to the interaction based on media type (for example, e-mail or chat) and customer segment (for example, Gold or Silver). Note: Setting the priority of an interaction is a Universal Routing Server function that is not directly related to target selection, but is normally done prior to target selection as a way to segment interactions.
- If the last agent exists, the workflow routes to the agent based on variable, setting a timeout of five seconds.
- If the last agent used is unavailable (timeout exceeded), the workflow routes to an Agent Group that is properly skilled to handle this type of interaction.
- There is an Escalation interaction queue configured as an outgoing interaction queue, so the agent can select this interaction queue from the desktop application in case he cannot handle the interaction himself and he needs to escalate it.

The Route Interaction block has the following properties:

Name Property

Find this property's details under [Common Properties](#).

Block Notes Property

Find this property's details under [Common Properties](#).

Condition Property

Find this property's details under [Common Properties](#).

Detach Property

Controls whether the Orchestration Platform should <detach> an interaction from the current session before routing to reserved targets. When this property is set to true, the interaction is detached from the current session.

Note: A Project properties option, **Interaction Detach**, in the Orchestration Options dialog can generate the detach attribute in the <ixn:redirect> tag in the Routing blocks. See [Detaching Interactions from Sessions](#).

Detach Timeout Property

Use to specify how long to attempt to <detach> if an initial attempt fails with an invalidstate error. Specify the timeout in milliseconds. If set to 0, no further attempt to detach is made. After the timeout, if the <detach> is not successful, no further attempts will be made and the block will attempt to reclaim the interaction back into the current session using <attach>.

Activity Property

Optional. Click the down arrow and select the variable that contains the Activity to be used for Workforce Management-based routing.

Clear Targets Property

Optional. Select **true** if targets listed in the object should be retained after the interaction moves on through the workflow and encounters other Route Interaction object. For more information, see the [Clear Targets](#) description for the voice interaction Target block.

Cut Off Time Property

Optional. Click the down arrow and select the variable that contains the cut-off time (in seconds) that defines the time window in which a potential target must be assigned to the activity defined in the Activity property above.

Enable Status Property

Find this property's details under [Common Properties](#).

Exceptions Property

Find this property's details under [Common Properties](#).

Expected Wait Time Property

To use this optional property, click the down arrow under Value and select a variable to contain the expected wait time that the interaction will be given in the queue. The selected variable will be populated with the respective output value obtained from the operations described next.

Starting with 8.1.4, the Target block and Route Interaction block provide an integrated mechanism to playback the estimated waiting time to customers, including defining the playback repeat interval. To implement this mechanism, the Target and Route Interaction blocks have new properties (variables) to capture the result of [queue.query.done](#).

- [Expected Wait Time](#)
- [Login Size](#)
- [Position in Queue](#)
- [Request ID](#)
- [Total Size](#)
- [Queue Poll Rate](#)

If any of the above five properties are set, the application does a `queue:query` after the `queue.submit.requestid`.

The `queue:query` is repeated every x secs until `queue.submit.done` is received. There is no additional output.

The variables used for the five properties can be used in a Busy Treatment block, such as [Play Application](#). Or you may put the Target block in a parallel leg and use the variables (for example, to speak the estimate wait time) in another leg.

If the call is distributed right away, then the application is presented an `error.queue.query` event (the `queue:query` is processed after the `queue.submit.done`). If nothing is done, that unexpected error will terminate the application. As a result:

- When assigning a variable to any of the above five properties, you will be prompted to automatically add a target-less exception for `error.queue.query`.
- Diagram validation will show a warning if one of the five properties is set and no handler is defined in the Target block (or one of its parents, // or the [Entry block](#)).

Hints Property

This property is for use by Orchestration Server. Its use is described in various action elements referenced in the *Orchestration Developer's Guide*.

It can be used to specify extension data in Treatment blocks. To do this, use an ECMAScript block to create an ECMAScript object and assign properties to it. Then specify this object in the Hints property by selecting the variable whose content is a JSON object. This object is passed to ORS at runtime.

For example, define variable `myExtensions` and `myHints` and set them as shown below in an ECMAScript block.

```
myExtensions={'NO_ANSWER_TIMEOUT':'10','NO_ANSWER_OVERFLOW':'recall','NO_ANSWER_ACTION':'notread'  
myHints = { 'extensions' : myExtensions }; Then specify myHints as the value of the Hints  
property in the Route Interaction object.
```

Include Requests from Previous Blocks Property

This property controls whether the block should transition if a target from previous Target block is selected even though it may not be specified in the current block. Set it to true for cascaded target lookups. If set to false, the block will wait until a target specified in the current block is selected for routing.

Interaction ID Property

Set to a meaningful value or keep the default value, which is the system variable `InteractionId`. Can be used for "interaction-less" processing for scenarios where the `InteractionId` variable is not automatically initialized, but instead must wait for an event. An example would be an SCXML application triggered by a Web Service that does not add an interaction. Background: Previous to 8.1.1, Composer did not expose an Interaction ID property. Instead, when ORS started processing an interaction, a generated SCXML application automatically initialized the system variable, `InteractionId`. This variable was then used internally by Routing and certain eServices blocks when interacting with ORS. With the introduction of support for Interaction-less processing, you can now define a specific event `IPD Wait_For_Event_property` to initialize `InteractionId`, or not define an event at all. For scenarios with an interaction (`IPD Diagram/Wait For Event=interaction.present` for example), you may keep the default value for the Interaction ID property. The default value is the system variable `InteractionId`, which is initialized automatically in this case. For other scenarios (any scenario where the system variable `InteractionId` is not set), you may choose to:

1. Not use blocks that require an Interaction ID
2. And/or set the Interaction ID property to a meaningful value
3. And/or assign a meaningful value to the `InteractionId` system variable

Logged In Only Property

Select **true** or **false** to indicate whether only logged in agents can pull interactions out of this Workbin. Use to prevent logged out agents from pulling interactions. Selecting true = logged in agents only.

Logging Details Property

Find this property's details under [Common Properties](#).

Login Size Property

Select the variable to contain the number of agents logged in that can be targeted for the request (you must have URS 8.1.3+). The selected variable will be populated with the respective output value obtained from the operations described in the [Expected Wait Time](#) property.

Log Level Property

Find this property's details under [Common Properties](#).

ORS Extensions Property

Starting with 8.1.4, Composer blocks used to build routing applications (with the exception of the Disconnect and EndParallel blocks) add a new [ORS Extensions](#) property.

Pass Context Property

This property accepts true/false values. When set to true and Detach is also true:

- URL built with the block name is stored into this interaction's user data (user data key name is '_composer_originating_session') just before detaching the interaction. That URL will be used by the orchestration destination session (that is the new orchestration session started to handle the interaction after it was redirected to an other routing point) to request the context of the originating session. After the processing for this block is over, the originating session is blocked until the destination session actually reads the context. The context consists of the system and user [variables](#).

Position in Queue Property

Click the down arrow under Value and select the variable to contain the position that the interaction will be given in the queue. The selected variable will be populated with the respective output value obtained from the operations described in the **Expected Wait Time** property.

Priority Property (Queue)

To use this optional property, click the down arrow under Value and select the variable, which contains a value expression returning the priority that the interaction will be given in the queue. For more information, see <http://www.w3.org/TR/scxml/#ValueExpressions>.

Priority Property (Target Selection)

To use this optional property, click the down arrow under Value and select the variable, which contains a value expression returning the priority that the interaction will be given during target selection.

Queue Poll Rate Property

Select the variable to contain how frequently the block will poll for latest values and populate selected variables.

Queue for Existing Interaction Property

Optional. To specify a queue for an existing interaction:

1. Click under **Value** to display the  button.
2. Click **Add** to open the Queue for Existing Interaction dialog box. Do one of the following:
 - If you are **connected to Configuration Server**, select Configuration Server. Select the interaction queue from the **Value** field. This is the interaction queue to which the incoming interaction has to be sent. Queues listed here were previously defined with the **Interaction Queue** block.
 - Select **Literal** and enter the name of the interaction queue in the Value field.
 - Select a variable (introduced in 8.1.420).
3. Click **OK**.

Queue for Outgoing Interaction Property

Use to create a new interaction. Only one new interaction may be created. The agent must close the existing interaction with no further processing allowed.



1. Click under **Value** to display the  button.
2. Click **Add** to open the Queue for Outgoing Interaction dialog box. Do one of the following:
 - If you are **connected to Configuration Server**, select **Configuration Server**. Select the interaction queue from the **Value** field. This is the interaction queue to which any new interaction generated has to be sent. For example, the agent might create a new e-mail to a supervisor as a result of handling another interaction. Queues listed here were previously defined with the **Interaction Queue** block.
 - Select **Literal** and enter the name of the interaction queue in the **Value** field.
 - Select a variable (introduced in 8.1.420).
3. Click **OK**.

Request ID Property

Set to a meaningful value or keep the default value, which is the system variable system.ANI. The selected variable will be populated with the respective output value obtained from the operations described in the **Expected Wait Time** property.

Route Property



Use this property to set the SCXML <queue:submit> route attribute.

1. Click under Value to display the  button.
2. Click the  button to open the Route dialog box.
3. Select one of the following:
 - **Variable**. Then for **Value**, select the variable that contains either True (default) or False.
 - **Literal**. Then for **Value**, enter either **True** or **False**.

When set to false, the functional module will not attempt to route the associated interaction.

Statistic Property

Optional. If you wish to route based on the value of a statistic:

-
1. Click under Value to display the  button.
 2. Click the  button to open the Statistic dialog box.
 3. Select one of the following:
 - **Literal.** For Value, you can write in a URS-predefined statistic or a custom statistic created with [Statistics Builder](#).
 - **Variable.**
 - **Configuration Server** to select a statistic. In order to select a statistic, you must be [connected to Configuration Server](#) and have set the option to use [URS Predefined statistics](#).
 4. Click OK when through in the dialog box.

The URS predefined statistics are described in the [Universal Routing 8.1 Reference Manual](#).

The statistic you select is used by Universal Routing Server to determine which target to route the interaction to if more than one target is available. After defining a complete set of available agents (taking agent capacity rules into consideration, if configured), URS applies the selection criteria specified in the Target block, which can include using the minimum or maximum value of the statistic (see Statistics Order property).

Statistics Order Property

Optional. This property can work with the Statistics property. Select **Max** or **Min** to specify whether the interaction should be routed to the target with the maximum or the minimum value of the statistic.

Target Component Selected

Select a variable containing the agent-level target to which the interaction was routed or should be routed to definitively.

- If the target specified in `<submit>` and selected for routing is of type Agent, Place, Queue, or Routing Point, this contains the target itself.
- If the desired target type is Agent Group, Place Group, or Queue Group, the function returns the agent, place, or queue from the corresponding group to which the interaction was sent.

The target format is `Name@StatServerName.Type`. The selected variable will be updated with the target information after receiving a `queue.submit.done`.

Target Deviation From Ideal Agent

New with 8.1.410.14. Select a variable to hold the result of calling the Universal Routing Server (URS)

TargetListSelected function to calculate a value indicating an agent target's deviation from **ideal agent** to handle an interaction. When the property is assigned to a variable, Composer makes a call to URS right after getting `queue.submit.done`:

```
'urs/call/@' + system.InteractionID + '/func/TargetListSelected?params=[]'
```

URS returns a string similar to the sample below:

```
return:ok|dn:7001|rdn:7001|switch:SIP_Switch|agent:KSippola|place:SIP_Server_Place1|target_locat
```

If the **Set Ideal Agent block** is used before the Route Interaction block, the URS reply includes a mismatch key-value pair. The below sample was obtained with: `SetIdealAgent[Billing > 6]` and the target with `Skill Billing == 5`).

```
return:ok|dn:7001|rdn:7001|switch:SIP_Switch|agent:KSippola|place:SIP_Server_Place1|target_locat
```

In this sample, the Target Deviation From Ideal Agent variable is assigned the (integer) value (i.e., 2) of the mismatch key-value pair when available, undefined otherwise.

Target Object Selected

Select a variable containing the high-level target (one that you specify in a `<submit>`) to which the interaction was routed or should be routed to definitively. If a skill expression is used, the function returns: `?:SkillExpression@statserver.GA` or even `?GroupName:SkillExpression@statserver.GA`. The target format is `Name@StatServerName.Type`. The selected variable will be updated with the target information after receiving a `queue.submit.done`.

Target Queue Selected Property

Select a variable containing the DN and the switch name of the target to which the interaction was routed or should be routed to definitively. The selected variable will be updated with the target information after receiving a `queue.submit.done`.

Total Size Property

Select the variable to contain the total number of agents that can be targeted for the request. The selected variable will be populated with the respective output value obtained from the operations described in the **Expected Wait Time_Property**. You must have installed Universal Routing Server 8.1.3+.

Targets Property

Use this property to specify routing targets and for percentage or conditional routing.

1. If you have not already done so, [connect to Configuration Server](#).
2. Opposite the Targets property, click under **Value**.
3. Click the ... button. The Targets dialog box opens.

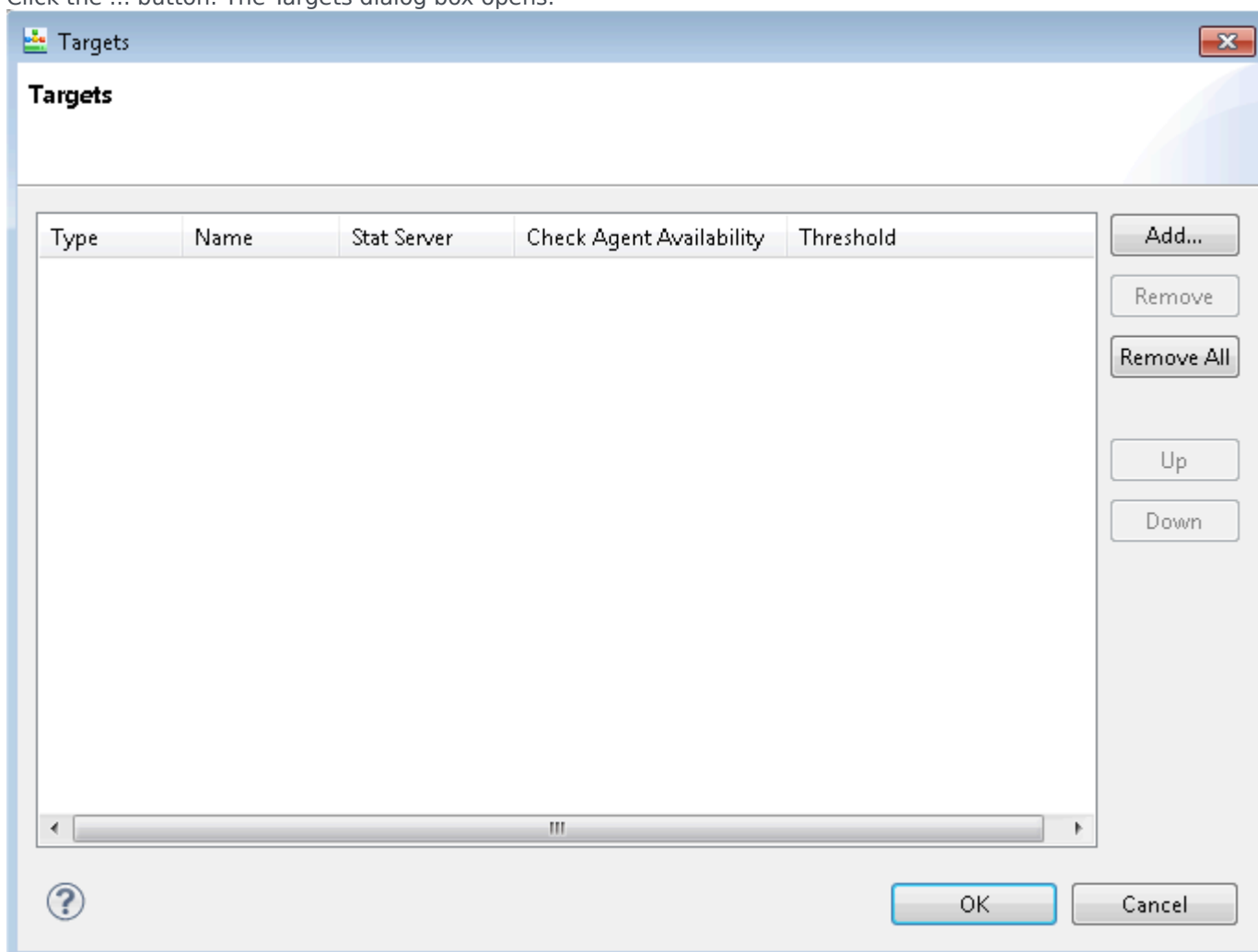

The figure above shows the dialog box when **Min** or **Max** is selected for the [Statistics Order](#) property. In this case, a Stat Server column appears. If you select **Percentage** for the Statistics Order property, a **Weight** column appears instead of a Stat Server column (see Statistics Order property above).

4. Click **Add** in the Targets dialog box.
5. Click under **Type** to display a down arrow.
6. You can route based on various criteria. Click the down arrow and select the target Type (defined in Genesys Administrator): Agent, AgentGroup, **LCA**, Place, PlaceGroup, Skill, List object or Variable. At

runtime, the application reads the key-value pairs in the targets section. The name part of the key-value pair can be used at your convenience. Only the value part of the key-value pair is read by the application and must be defined as indicated under <targetid> in the *Orchestration Developer's Guide*, [Parameter Elements](#). For example, a valid value is: ksippo@.A

7. Click under **Name** to display to bring up a dialog box. Targets of the selected **Type** appear for selection.
8. Select the name of routing target and click **OK**. You have the option to add another target.
9. If applicable, select a **Stat Server**. Or, if you selected **Percentage** for the Statistics Order property, enter the **Weight** column.
10. Starting with 8.1.440.18, you can check agent availability in the Route Interaction block before executing <queue:submit> by selecting true for **Check Agent Availability**. This "skip targets" feature can improve the efficiency of finding an agent by enhancing or relaxing the target criteria without waiting until the routing timeout is reached in the Route Interaction block. If multiple/mixed target types are used in the dialog, the skip target-enabled target types will take precedence and will cause Route Interaction block execution to be skipped if no agent is available. In this case, a warning message appears stating that the Route Interaction block uses different target types with skip targets enabled.
11. The Route Interaction block adds a new "Skip Target" output in the workflow diagram if **Check Agent availability** is enabled for one of the target types in the block. **Note:** This feature is not supported for the following target types: List Objects, Skill expressions, and Variables.
12. Starting with 8.1.440.18, you also have the option of using the [threshold functions](#) for conditional routing. You can use Threshold to define additional conditions the target must meet to be considered as valid routing target. Click the button under Threshold to open [Expression Builder](#) where you can create a threshold expression. See [Creating Threshold Expressions](#) in the Target block topic. Threshold is not supported for the following target types: List Objects and Variables.
13. Click **OK** when through in the Targets dialog box.

Important



The option of routing an interaction to the last called agent (LCA) is available only from release 8.1.510.12

Timeout Property

Optional. Enter an integer to specify the time in seconds an interaction waits for an available target or keep the default of 90 (added in 8.1.440.18). If the timeout expires before one of the targets is available, the interaction is routed to the error port (if the exception property is configured for the block).



Virtual Queue Property

Optional. A virtual queue a logical queue, not a physical queue. Interactions can be queued to a virtual queue if the specified targets are unavailable. To select a virtual queue.

-
1. Click under **Value** to display the  button.
 2. Click the  button to open the Virtual Queue dialog box.
 3. Select an Alias, Switch, and Number. For more information on these fields, start with the Framework Configuration Manager Help.
 4. Click OK.

Workbin Property

Use this property if you wish to route this interaction to an agent workbin. To select a workbin:

1. Click under Value to display the  button.
2. Click the  button to open the Workbin Properties dialog box.
3. Select a workbin previously defined with the **Workbin block**.
4. Optional. Click the **Show Unpublished Workbins** box.
5. Click **OK**.

Starting with 8.1.440.18, Composer adds support for dynamic Workbin selection.

- Composer adds variable support in Route interaction Block, Workbin property.
- A new Workbin Type property is added.
- You can use variables in the Route Interaction block Targets property when the Workbin property is used.

Workbin Type Property

This property, added in 8.1.440.18, works along with the Workbin property. See the Workbin property above. Select one of the following from the dropdown: **Agent, Agent Group, Place, Place Group**.

- If a Workbin block object is selected in the Workbin property, this property is auto-populated with the Workbin Block Owner property value.
- If a variable is selected in the Workbin property, you can edit the Workbin Type property to set the corresponding Owner type.

Routing Rule Block

Note: The Routing Rule block does not create routing rules. Instead, you select routing rules that currently exist in the Configuration Database, such as those created with Interaction Routing Designer as described in the [Universal Routing 8.1.x Reference Manual](#).

Routing rules specify the method of target selection for voice interactions. Composer supports using the following types of routing rules:

- Load Balancing
- Percentage
- Statistics

The Routing Rule block has the following properties:

Name Property

Find this property's details under [Common Properties](#). Enter the name of the Routing Rule block for the workflow. The name of the routing rule in the Configuration Database is entered in the Rule Name property below.

Block Notes Property

Find this property's details under [Common Properties](#).

Exceptions Property

Find this property's details under [Common Properties](#).

Condition Property

Find this property's details under [Common Properties](#).

Logging Details Property

Find this property's details under [Common Properties](#).

Log Level Property

Find this property's details under [Common Properties](#).

Enable Status Property

Find this property's details under [Common Properties](#).



Pass Context Property

This property accepts true/false values. When set to true and Detach is also true:

- URL built with the block name is stored into this interaction's user data (user data key name is '_composer_originating_session') just before detaching the interaction. That URL will be used by the orchestration destination session (that is the new orchestration session started to handle the interaction after it was redirected to an other routing point) to request the context of the originating session. After the processing for this block is over, the originating session is blocked until the destination session actually reads the context. The context consists of the system and user [variables](#).

Rule Name Property

Use this property to specify the routing rule name.

1. Click under Value to display the  button.
2. Click the  button to open the Rule Name dialog box.
3. From the Type dropdown menu, select **Literal**, **Variable**, or **Configuration Server**
 - If you select **Literal**, enter the name of an existing routing rule exactly how it appears in the Configuration Database. In Configuration Manager, Routing Rules are stored in the Transactions folder.
 - If you select **Variable**, select the name of the variable that contains routing rule.
 - If you select **Configuration Server** and are [connected](#), existing routing rules appear for selection based on the Rule Type property entry. Select a routing rule.
4. Click **OK** to close the dialog box.

Rule Type Property

Click the down arrow under Value and select one of the following:

-
- **Load Balancing**—Use to distribute voice interactions to Universal Routing Server (URS) queues according to statistic `StatEstimatedWaitTime` as described in the *Universal Routing 8.1 Reference Manual*.
 - **Percentage**—Use to distribute voice interactions to targets based on a set percentage for each target. When this criterion is used, every target must be supplied with a non-negative integer percentage.
 - **Statistics**—Use to route voice interactions. It uses a routing rule so that URS can obtain the values of defined statistics for targets from Stat Server.

Interaction ID Property

Set to a meaningful value or keep the default value, which is the system variable `InteractionId`.

Can be used for "interaction-less" processing for scenarios where the `InteractionId` variable is not automatically initialized, but instead must wait for an event. An example would be an SCXML application triggered by a Web Service that does not add an interaction.

Background: Previous to 8.1.1, Composer did not expose an `InteractionId` property. Instead, when ORS started processing an interaction, a generated SCXML application automatically initialized the system variable, `InteractionId`. This variable was then used internally by Routing and certain eServices blocks when interacting with ORS.

With the introduction of support for Interaction-less processing, you can now define a specific event (IPD Event Property) to initialize `InteractionId`, or not define an event at all.

For scenarios with an interaction (IPD Diagram/Event=`interaction.present` for example), you may keep the default value for the Interaction ID property. The default value is the system variable `InteractionId`, which is initialized automatically in this case.

For other scenarios (any scenario where the system variable `InteractionId` is not set), you may choose to:

1. Not use blocks that require an Interaction ID
2. And/or set the Interaction ID property to a meaningful value
3. And/or assign a meaningful value to the `InteractionId` system variable

Hints Property

This property is for future use by Orchestration Server. Its use will be described in various action elements reference in the Orchestration Server wiki.

Detach Property

Controls whether the Orchestration Platform should `<detach>` an interaction from the current session before routing the interaction. When this property is set to true, the interaction is detached from the

current session.

Note: A Project properties option, **Interaction Detach**, in the **Orchestration Options** dialog can generate the detach attribute in the <ixn:redirect> tag in the Routing blocks. See **Detaching Interactions from Sessions**.

Detach Timeout Property

Use to specify how long to attempt to <detach> if an initial attempt fails with an invalidstate error. Specify the timeout in milliseconds. If set to 0, no further attempt to detach is made. After the timeout, if the <detach> is not successful, no further attempts will be made and the block will attempt to reclaim the interaction back into the current session using <attach>.

ORS Extensions Property

Starting with 8.1.4, Composer blocks used to build routing applications (with the exception of the Disconnect and EndParallel blocks) add a new **ORS Extensions** property.

Set Ideal Agent Block

Starting with Composer release 8.1.410.14, workflow diagrams add a Set Ideal Agent block to the Routing palette, which allows you to select the most ideal agent to handle an interaction when more than one agent is available. You can also use this functionality to select the most ideal interaction when there is more than one interaction competing for the same agent. The Composer Set Ideal Agent block invokes the Universal Routing Set Ideal Agent functionality described in [Using Agent Skills for Ideal Agent Selection](#).

This block has two specific Set Ideal Agent properties: **Interaction ID** (default: system.InteractionID) and **Target** (provides support for Skill Expression Builder).

Important

In order to use this block, you must have installed Universal Routing Server release 8.1.400.22 or later.

Name Property

Find this property's details under [Common Properties](#).

Block Notes Property

Find this property's details under [Common Properties](#).

Exceptions Property

Find this property's details under [Common Properties](#). The `error.session.fetch` exception is supported.

Condition Property

Find this property's details under [Common Properties](#).

Logging Details Property

Find this property's details under [Common Properties](#).

Log Level Property

Find this property's details under [Common Properties](#).

Interaction ID Property

Set to a meaningful value or keep the default value, which is the system variable `system.InteractionID`. Can be used for interaction-less processing for scenarios where the `InteractionId` variable is not automatically initialized, but instead must wait for an event. An example would be an SCXML application triggered by a Web Service that does not add an interaction.

ORS Extensions Property



Starting with release 8.1.4, Composer blocks used to build routing applications (with the exception of the Disconnect and EndParallel blocks) add a new [ORS Extensions](#) property.

Enable Status Property

Find this property's details under [Common Properties](#).

Target Property

Use this property to specify a skill expression.

1. If you have not already done so, [connect to Configuration Server](#).
2. Opposite the **Target** property, click under **Value** to display the  button.
3. Click the  button. Expression Builder opens with **Target** selected and available Skills listed below.
4. Construct a skill expression to select the ideal agent as described in [Using Agent Skills for Ideal Agent Selection](#).

[+] Set Ideal Agent Code Sample

```
<state id="SetIdealAgent">
  <onentry>
    <log expr="_sessionid + ': Inside Set Ideal Agent Block: SetIdealAgent'" />
    <script>var skillepr = ["Billing >10"];</script>
    <session:fetch requestid="App_SetIdealAgent['requestid']" srcexpr="'urs/call/@' +
system.InteractionID + '/func/SetIdealAgent'" timeout="30" method="'urs'">
      <param name= "params" expr="uneval(skillepr)" />
    </session:fetch>
  </onentry>
  <transition event="session.fetch.done"
cond="_event.data.requestid==App_SetIdealAgent['requestid']" target="$_MY_PREFIX_$.Exit1">
    <log expr="'Composer Application:default Block: SetIdealAgent'" />
    <log expr="'Session FETCH DONE'" />
    <script>storeEvent("SetIdealAgent", _event);</script>
  </transition>
</state>
```

Single Step Transfer Block

Use this block for both voice and multimedia interactions to force Universal Routing Server (URS) to route the interaction to the first target type (ACD Queue, Destination Label, or Routing Point) without any other operations. The interaction is then routed unconditionally, i.e., URS does not check the status of the destination. Warning! Force should always be thought of as a last plan of action and therefore used infrequently. The Force Route block has the following properties:

Name Property

Find this property's details under [Common Properties](#).

Block Notes Property

Find this property's details under [Common Properties](#).

Destination Property

Use this property to specify the routing transfer destination. Find this property's details under [Common Properties](#).

Exceptions Property

Find this property's details under [Common Properties](#).

From Property

A value expression, which returns the address that this interaction is to be redirected from. Set this property to the variable DNIS for voice interactions, or to the variable InteractionID for multimedia interactions. Composer will automatically set this property to DNIS or to InteractionID when the Destination property is set (respectively) to a Target Block or to a Route Interaction block. This property also supports a Resource type, which allows you to specify key-values. For additional information, see the [Force Route Block](#).

Condition Property

Find this property's details under [Common Properties](#).

Logging Details Property

Find this property's details under [Common Properties](#).

Log Level Property

Find this property's details under [Common Properties](#).

Interaction ID Property

This property specifies the ID of the Interaction to detach from this ORS session. Set to a meaningful value or keep the default value, which is the system variable InteractionId. Find more details under [Common Properties](#).

Hints Property

This property is for future use by Orchestration Server. Its use will be described in various action elements reference in the Orchestration Server wiki.

Detach Property

Use for multi-site routing. Controls whether the Orchestration Platform should <detach> an interaction from the current session before routing to the specified targets. When this property is set to true, the interaction is detached from the current session.

Detach Timeout Property

Use to specify how long to attempt to <detach> if an initial attempt fails with an invalidstate error. Specify the timeout in milliseconds. If set to 0, no further attempt to detach is made. After the timeout, if the <detach> is not successful, no further attempts will be made and the block will attempt to reclaim the interaction back into the current session using <attach>.

Pass Context

This property accepts true/false values. When set to true and Detach is also true:

- URL built with the block name is stored into this interaction's user data (user data key name is '_composer_originating_session') just before detaching the interaction. That URL will be used by the orchestration destination session (that is the new orchestration session started to handle the interaction after it was redirected to an other routing point) to request the context of the originating session. After the processing for this block is over, the originating session is blocked until the destination session actually reads the context. The context consists of the system and user [variables](#).

Pass Context Timeout

This property can be passed a positive integer value or a variable. This is the maximum time to wait (in seconds) for the destination session to read the originating session's context.

Enable Status Property

Find this property's details under [Common Properties](#).

Stop Interaction Block

Use this block to send a request to Interaction Server to stop processing an interaction. This results in an notification to [Universal Contact Server](#), or to a third party server, that processing for this interaction is finished. You can also:

- Select a reason code (configurable through Configuration Manager or Genesys Administrator), which is attached to the interaction.
- Indicate that the interaction should be deleted from the Universal Contact Server database.

Important Note! Each interaction path in a workflow for multimedia interactions should end with one of these blocks: [Stop Interaction](#), [Queue Interaction](#), or [Route Interaction](#).

Also see information in [App_Terminate_Ixn_On_Exit](#) variable.

Use Case

- A customer support engineer is using Siebel to track customer support tickets. After a specific ticket is updated by the engineer, an action that he takes in Siebel triggers a Siebel workflow.
- That workflow initiates an event that generates, using the Genesys Open Media API, an interaction process diagram, which in turn, triggers a routing workflow.
- The workflow specifies that an [e-mail should be created](#).
- The workflow specifies that the e-mail should be sent to the customer, from a Customer Support e-mail address, copying specific interested parties.
- If the process of sending the e-mail fails for any reason, the e-mail can be queued to a different queue (for example, so it can be manually reviewed and perhaps the customer will be notified by phone instead).
- If the process of sending out the e-mail is successful, the workflow would specify that the processing of the interaction should be stopped, and will provide the appropriate reason. This information will be part of a notification that is provided to Universal Contact Server or to a third party server.

The Stop Interaction block has the following properties:

Name Property

Find this property's details under [Common Properties](#).

Block Notes Property

Find this property's details under [Common Properties](#).

Exceptions Property

Find this property's details under [Common Properties](#).

Condition Property

Find this property's details under [Common Properties](#).

Logging Details Property

Find this property's details under [Common Properties](#).

Log Level Property

Find this property's details under [Common Properties](#).

Enable Status Property

Find this property's details under [Common Properties](#).



Notify Property

Use this property to select a Universal Contact Server or third party media server to notify about the stop processing action.

1. Click under Value to display the  button.
2. Click the button to open the Notify dialog box.
3. Under **Notify**, you have the option of checking the box to delete the interaction from Universal Contact Server Database.
4. Click one of the following buttons: **Notify UCS** or **Notify Third Party Server**.

5. Under **Details**:

If you selected **Notify Third Party Server**:

- Opposite **Application Type**, click the down arrow to select the type in the Configuration Database. See the Application Type note below.
- Opposite **Application Name**, click the  button. In the resulting Notify dialog box, select **Literal** if you wish to manually enter the name. Select Configuration Server if you wish to select it from the **Value** field.
- Opposite **Service**, click the  button to enter the type of notification service for the third party server.
- Opposite **Name**, click the  button to enter the name of the notification service for the third party server.

If you selected **Notify UCS**, select the Application Name of the Universal Contact Server. The remaining fields are disabled.

Note on Application Type

The supported Application Type names are:

- **ChatServer**
- **ClassificationServer**
- **ContactServer,**
- **EmailServer**
- **GenericClient**
- **GenericServer**
- **ThirdPartyApp**
- **ThirdPartyServer**

Interaction Server treats any connection in its Connections list as an ESP server, except some well known types, like DBServer, Stat Server, T-Server, and URS. Any new Application Type will also be treated as an ESP server. No special configuration is required.

With Application Name, if there is a connection to it from Interaction Server, then the specific server will be called (or its backup). If only type is specified, Interaction Server will select any one of the applications in its Connections list having the specified type. This works fine with specific types, like E-mail server or Chat Server, but for generic types, there can be multiple different applications with the same generic type. So to call a generic server, the name must be specified.

Load balancing can still be used. Starting from 7.6.1 ESP server clusters are supported. The cluster application name (with type ApplicationCluster) can be specified in ESP request. In this case, Interaction Server will load balance between applications the cluster has connections to. Interaction Server will also always check that the ESP server supports the required tenant (has it in tenants list) and will only load balance between ESP servers that support required tenant.

6. Click **OK** to close the Notify dialog box.

Use Notify Property

Select **true** to notify Universal Contact Server or the third party server about the stopping the processing of the interaction including the reason.

Interaction ID Property

Set to a meaningful value or keep the default value, which is the system variable InteractionId.

Can be used for "interaction-less" processing for scenarios where the InteractionId variable is not automatically initialized, but instead must wait for an event. An example would be an SCXML application triggered by a Web Service that does not add an interaction.

Background: Previous to 8.1.1, Composer did not expose an Interaction ID property. Instead, when ORS started processing an interaction, a generated SCXML application automatically initialized the system variable, InteractionId. This variable was then used internally by Routing and certain eServices blocks when interacting with ORS.

With the introduction of support for Interaction-less processing, you can now define a specific event (**IPD Wait_Event property**) to initialize InteractionId, or not define an event at all.

For scenarios with an interaction (IPD Diagram/Wait Event=interaction.present for example), you may keep the default value for the Interaction ID property. The default value is the system variable InteractionId, which is initialized automatically in this case.

For other scenarios (any scenario where the system variable InteractionId is not set), you may choose to:

- Not use blocks that require an Interaction ID
- And/or set the Interaction ID property to a meaningful value
- And/or assign a meaningful value to the InteractionId system variable

Reason to Stop Interaction Property

Use this property to get the stop processing reason code.

1. Click under **Value** to display the  button.
2. Click the button to open the Reason to Stop Interaction dialog box.
3. Opposite **Type**, select one of the following as the source for the reason code:
 - **Literal** to enter the reason code manually in the Value field.
 - **Configuration Server** to select a predefined reason code as Business Attribute in the Value field.
 - **Variable** to select a variable for the reason code in the Value field.

4. Click **OK** to close the dialog box.

ORS Extensions Property

Starting with 8.1.4, Composer blocks used to build routing applications (with the exception of the Disconnect and EndParallel blocks) add a new **ORS Extensions** property.

Target Block

Use to route a voice interaction to a target (use [Route Interaction](#) for multimedia interactions). Also use for [percentage routing and conditional routing](#) using the [threshold functions](#).

- See note on [excluding agents](#) before Target blocks.

The Target block has the following properties:

Name Property

Find this property's details under [Common Properties](#).

Block Notes Property

Find this property's details under [Common Properties](#).

Activity Property

Starting with 8.1.410.03, you can specify a Workforce Management [Activity](#) for routing and a related Cut Off Time (see property below) to specify a timeout. Select the variable that contains the WFM Activity.

Clear Targets Property

Click the down arrow and select true or false (default). If set to true, URS retains the targets listed in the block after the interaction moves on through the strategy and encounters other Target blocks.

- This option is only applicable if more than one Target block is used along the same path in the strategy. It has nothing to do with how agents specified within the block are evaluated for availability. If no additional Target blocks are included in the path and no agent is available, the interaction is default-routed. If more than one agent is available, URS uses the statistic specified in the Statistics property to determine which agent receives the interaction.
- If Clear Targets = false and the current interaction encounters a Target block later in the strategy, the targets in this block are added to those of the next Target block. If Clear Target = true, the targets are not added to the list of any Target block that the interaction encounters later in the strategy.

For example, assume two Target blocks are used in a strategy with the first Target block configured with three agents and a timeout of 30 seconds and the second Target block configured with four new agents and a timeout of 60 seconds. The Clear Targets setting determines which agents are considered as targets for an interaction.

- Clear Targets = true. In the first Target block, URS waits for 30 seconds for any of the three agents to become available. If none are available before the timeout expires, the strategy resumes. When the second Target block is encountered, URS only considers these four new agents as possible targets during the 60-second timeout. URS does not consider (clears) the first three agents as possible targets.
- Clear Targets = false and none of the agents listed in the first Target block are available. When the interaction encounters the second Target block, URS considers the first three agents and the four new agents as possible targets during the 60-second timeout set in this object. If no more Target blocks follow the second Target block and no agents are available before the timeout expires, the interaction is routed to the error port.

Condition Property

Find this property's details under [Common Properties](#).

Cut Off Time Property

Starting with 8.1.430.03, you can specify the timeout number of seconds to wait for retrieving an Workforce Management Activity.

Code generation:

```
<queue:submit interactionid="system.InteractionID" requestid="App_Target_SCXML['requestid']"
route="false" timeout="20" clearontimeout="false">
  <queue:targets>
    <queue:activity cutofftime="10" name="varWFMActivity"/>
  </queue:targets>
</queue:submit>
```

Detach Property

Controls whether the Orchestration Platform should <detach> an interaction from the current session before routing to reserved targets. When this property is set to true, the interaction is detached from the current session.

Note: A Project properties option, **Interaction Detach**, in the Orchestration Options dialog can generate the detach attribute in the <ixn:redirect> tag in the Routing blocks. See [Detaching Interactions from Sessions](#).

Detach Timeout Property

Use to specify how long to attempt to <detach> if an initial attempt fails with an invalidstate error. Specify the timeout in milliseconds. If set to 0, no further attempt to detach is made. After the timeout, if the <detach> is not successful, no further attempts will be made and the block will attempt to reclaim the interaction back into the current session using <attach>.

Enable Status Property

Find this property's details under [Common Properties](#).

Exceptions Property

Find this property's details under [Common Properties](#). Note: Exceptions for Busy treatment blocks should be handled in the Target block to which they are connected and not in the Busy treatment blocks themselves. Busy treatment exceptions are raised as the `error.queue.submit` exception and not as exceptions listed in individual treatment blocks.

Expected Wait Time Property

To use this optional property, click the down arrow under Value and select a variable to contain the expected wait time that the interaction will be given in the queue. The selected variable will be populated with the respective output value obtained from the operations described next.

Starting with 8.1.4, the Target block and Route Interaction block provide an integrated mechanism to playback the estimated waiting time to customers, including defining the playback repeat interval. To implement this mechanism, the Target and Route Interaction blocks have new properties (variables) to capture the result of `queue.query.done`. There is also a property (Advanced properties) to configure the poll period (1 second by default).

- [Login Size](#)
- [Position in Queue](#)
- [Request ID](#)
- [Total Size](#)
- [Queue Poll Rate](#)

If any of the above five properties are set, the application does a `queue:query` after the `queue.submit.requestid`.

The `queue:query` is repeated every x secs until `queue.submit.done` is received. There is no additional output.



The variables used for the five properties can be used in a Busy Treatment block, such as **Play Application**. Or you may put the Target block in a parallel leg and use the variables (for example, to speak the estimate wait time) in another leg.

If the call is distributed right away, then the application is presented an `error.queue.query` event (the `queue:query` is processed after the `queue.submit.done`). If nothing is done, that unexpected error will terminate the application. As a result:

- When assigning a variable to any of the above five properties, you will be prompted to automatically add a target-less exception for `error.queue.query`.
- Diagram validation will show a warning if one of the five properties is set and no handler is defined in the Target block (or one of its parents, // or the **Entry block**).

From Property

A value expression, which returns the address that this interaction is to be redirected from. Set this property to the variable `DNIS` for voice interactions, or to the variable `InteractionID` for multimedia interactions. Composer will automatically set this property to `DNIS` or to `InteractionID` when the Destination property is set (respectively) to a Target Block or to a Route Interaction block. When the Destination property is not assigned a Block Reference value, you must select the appropriate **From** value.

1. Click under **Value** to display the  button.
2. Click the  button to open the **From** dialog box.
3. Select one of the following:
 - **Literal.** For Value, you can specify:
 - An agent: `<agent id>`
 - A place: `<place id>`
 - A DN: `<number>`
 - An e-mail address: `<username>@<host>` or `_origin` or `_origin.all` or `_udata`
 - A customer number: `<dn number>`
 - A target format addresses: `<Target DN>`

See the [Orchestration Server Documentation Wiki](#) for those literals that apply to multimedia interactions only.

- **Variable.** If the variable contains a string, see Literal above. If the value is a JSON object, Value can refer to:
 - An agent: `{agent: <agent id>, type:A}`
 - An agent group: `{agent: <name>, type:AG}`
 - A place: `{place: <place id>, type:AP}`

-
- A place group: {place: <name>, type:PG}
 - A DN: {dn: <number>, type:Q or RP or DN, switch:<switch name>}
 - An interaction queue: {id: <q name>, type:iq }
 - A workbin: {id: <wb name>, type:wb<owner>}
 - A customer number: {dn: <number>}
 - A target format addresses: Resource Object from the `queue.submit.done` event (the Target Block [Resource Selected property](#)).

See the [Orchestration Server Documentation Wiki](#) for those literals that apply to multimedia interactions only.

- **Configuration Server** to select the from Switch//DN if `connected`.
- **Resource** to select a resource using properties that will form a JSON object.

See the [Orchestration Server Documentation Wiki](#).

4. Click **OK** to close the From dialog box.

Hints Property

This property is for use by Orchestration Server. Its use is described in various action elements referenced in the [Orchestration Developer's Guide](#).

Include Requests from Previous Blocks Property

This property controls whether the block should transition if a target from previous Target block is selected even though it may not be specified in the current block. Set it to true for cascaded target lookups. If set to false, the block will wait until a target specified in the current block is selected for routing.

Interaction ID Property

Set to a meaningful value or keep the default value, which is the system variable InteractionId. Set to a meaningful value or keep the default value, which is the system variable InteractionId. Find more details under [Common Properties](#).

Logging Details Property

Find this property's details under [Common Properties](#).

Login Size Property

Select the variable to contain the number of agents logged in that can be targeted for the request (you must have Universal Routing Server 8.1.3+). The selected variable will be populated with the respective output value obtained from the operations described in the [Expected Wait Time](#) property.

ORS Extensions Property

Starting with 8.1.4, Composer blocks used to build routing applications (with the exception of the Disconnect and EndParallel blocks) add a new [ORS Extensions](#) property.

Log Level Property

Find this property's details under [Common Properties](#).

Pass Context Property

This property accepts true/false values. When set to true and Detach is also true:

- URL built with the block name is stored into this interaction's user data (user data key name is '_composer_originating_session') just before detaching the interaction. That URL will be used by the orchestration destination session (the new orchestration session started to handle the interaction after it was redirected to an other routing point) to request the context of the originating session. After the processing for this block is over, the originating session is blocked until the destination session actually reads the context. The context consists of the system and user [variables](#).

Position in Queue Property

Click the down arrow under Value and select the variable to contain the position that the interaction will be given in the queue. The selected variable will be populated with the respective output value obtained from the operations described in the [Expected Wait Time](#) property.

Priority Property (Target Selection)

To use this optional property, click the down arrow under Value and select the variable, which contains a value expression returning the priority that the interaction will be given during target selection.

Priority Property (Queue)

To use this optional property, click the down arrow under **Value** and select the variable, which contains a value expression returning the priority that the interaction will be given in the queue. For more information, see [<http://www.w3.org/TR/scxml#ValueExpressions> <http://www.w3.org/TR/scxml/#ValueExpressions>].

Queue Poll Rate Property

Click the **Show Advanced Properties** button to view. Select the variable to contain how frequently the block will poll for latest values and populate selected variables.

Request ID Property



Set to a meaningful value or keep the default value, which is the system variable `system.ANI`. The selected variable will be populated with the respective output value obtained from the operations described in the **Expected Wait Time** property.

Resource Selected Property

Click the down arrow and select the variable that specifies the target resource for the interaction.

Route Property



Use this property to set the SCXML `<queue:submit>` route attribute. Also see the **Use Access Code** property below.

1. Click under **Value** to display the  button.
2. Click the  button to open the **Route** dialog box.
3. Select one of the following:
 - **Variable**. Then for **Value**, select the variable that contains either true (default) or false.
 - **Literal**. Then for **Value**, enter either true or false.

When set to false, the functional module will not attempt to route the associated interaction.

Statistics Property

Optional. If you wish to route based on the value of a statistic:

1. Click under **Value** to display the  button.
2. Click the  button to open the **Statistic** dialog box.
3. Select one of the following:
 - **Literal.** For Value, you can write in a URS-predefined statistic or a custom statistic created with [Statistics Builder](#).
 - **Variable.**
 - **Configuration Server** to select a statistic. In order to select a statistic, you must be [connected to Configuration Server](#) and have set the option to use [URS Predefined statistics](#).
4. Click **OK** when through in the dialog box.

The URS predefined statistics are described in the [Universal Routing 8.1 Reference Manual](#) .

The statistic you select is used by Universal Routing Server to determine which target to route the interaction to if more than one target is available. After defining a complete set of available agents (taking agent capacity rules into consideration, if configured), URS applies the selection criteria specified in the Target block, which can include using the minimum or maximum value of the statistic (see Statistics Order property).

Statistics Order Property

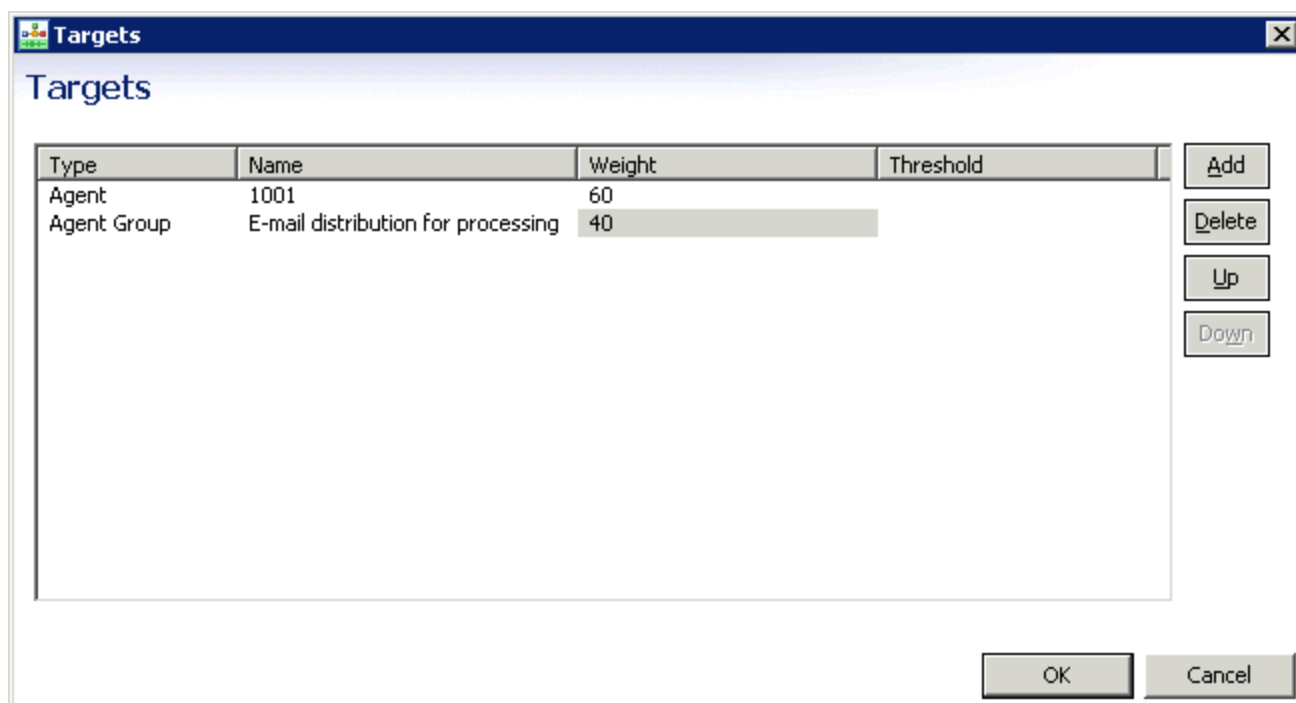

This property can work with the Statistics property.

- Select Max or Min to specify whether the interaction should be routed to the target with the maximum or the minimum value of the statistic.
- Select to route interactions to targets based on a [percentage allocation](#). This selection causes the dialog box that opens from the Targets property to display a column where you can specify a percentage for each target.



Targets Property

Use this property to specify routing targets and for percentage or conditional routing.

1. If you have not already done so, [connect to Configuration Server](#).
2. Opposite the Targets property, click under Value to display the  button.
3. Click the  button. The Targets dialog box opens.

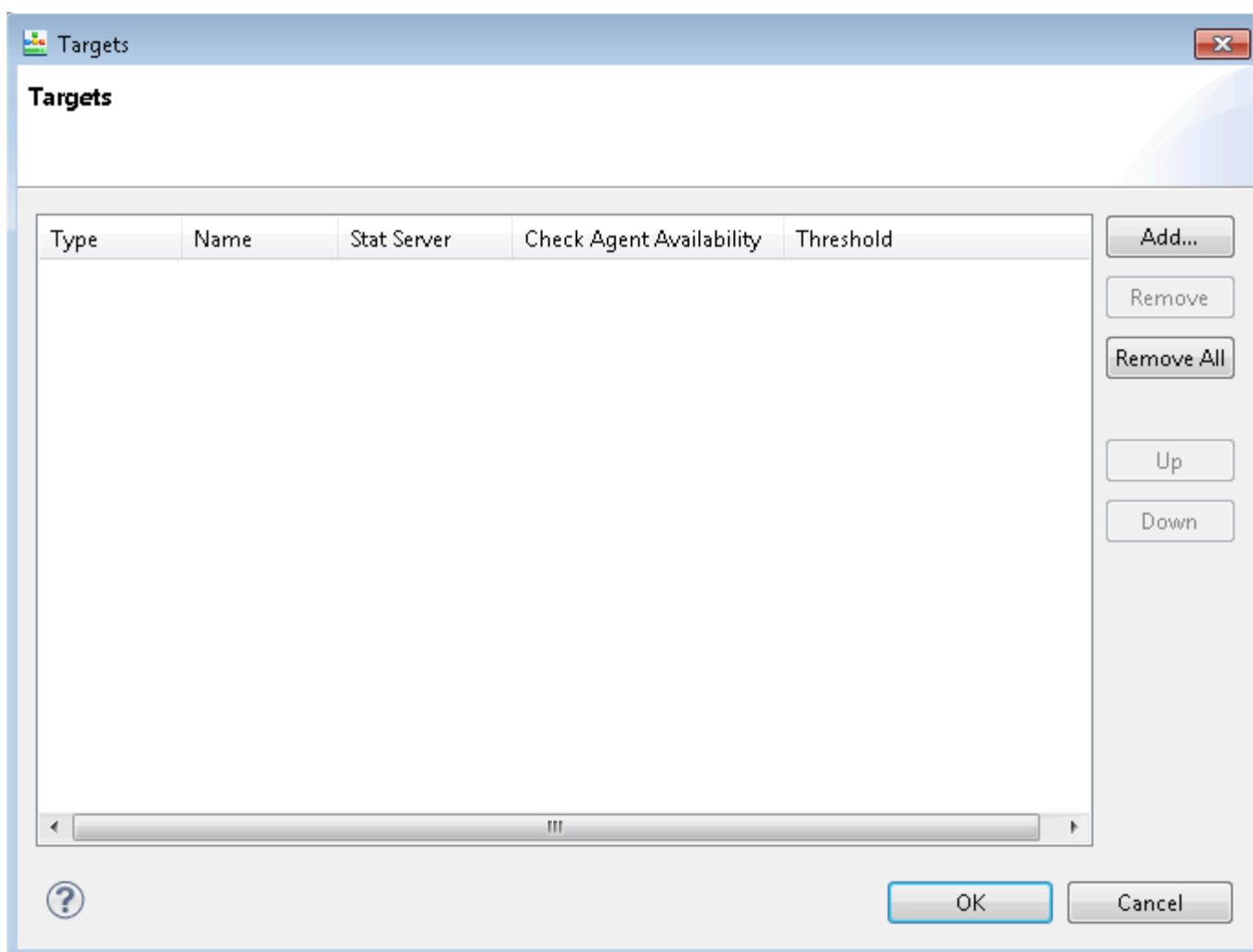

The figure above shows the dialog box when **Min** or **Max** is selected for the **Statistics Order** property. In this case, a **Stat Server** column appears. If you select **Percentage** for the **Statistics Order** property, a **Weight** column appears instead of a **Stat Server** column (see **Statistics Order** property above).

4. Click **Add** in the **Targets** dialog box.
5. Click under **Type** to display a down arrow.
6. You can route based on various criteria. Click the down arrow and select the target **Type** (defined in **Genesys Administrator**): **Agent**, **AgentGroup**, **ACDQueue**, **Campaign Group**, **Destination Label**, **LCA**, **Place**, **PlaceGroup**, **Queue Group**, **Route Point**, **Skill** or **Variable**. At runtime, the application reads the key-value pairs in the targets section. The name part of the key-value pair can be used at your convenience. Only the value part of the key-value pair is read by the application and must be defined as indicated under <targetid> in the *Orchestration Developer's Guide*, **Parameter Elements**. For example, a valid value is: ksippo@.A
7. Click under **Name** to display to bring up a dialog box. Targets of the selected **Type** appear for selection.
8. Select the name of routing target and click **OK**. You have the option to add another target.
9. If applicable, select a **Stat Server**. Or, if you selected **Percentage** for the **Statistics Order** property,

enter the **Weight** column.

10. Starting with 8.1.410.14, you can check agent availability in the Target block before executing `<queue:submit>` by selecting true for **Check Agent Availability**. This "skip targets" feature can improve the efficiency of finding an agent by enhancing or relaxing the target criteria without waiting until the routing timeout is reached in the Target block. If multiple/mixed target types are used in the dialog, the skip target-enabled target types will take precedence and will cause Target block execution to be skipped if no agent is available. In this case, a warning message appears stating that the Targets block uses different target types with skip targets enabled.
11. The Target block adds a new "Skip Target" output in the workflow diagram if **Check Agent availability** is enabled for one of the target types in the block. **Note:** This feature is not supported for the following target types: List Objects, Routing Points, Destination Labels, Campaign Groups, Skill expressions, and Variables.
12. Starting with 8.1.440.18, you also have the option of using the [threshold functions](#) for conditional routing. You can use Threshold to define additional conditions the target must meet to be considered as a valid routing target. Click the button under Threshold to open [Expression Builder](#) where you can create a threshold expression. See [Creating Threshold Expressions](#) below. Threshold is not supported for the following target types: List Objects and Variables.
13. Click OK when through in the Targets dialog box.

Important

The option of routing an interaction to the last called agent (LCA) is available only from release 8.1.510.12

Target Component Selected Property

Select a variable containing the agent-level target to which the interaction was routed or should be routed to definitively.

- If the target specified in `<submit>` and selected for routing is of type Agent, Place, Queue, or Routing Point, this contains the target itself.
- If the desired target type is Agent Group, Place Group, or Queue Group, the function returns the agent, place, or queue from the corresponding group the interaction was sent to.

The target format is `isName@StatServerName.Type`. The selected variable will be updated with the target information after receiving a `queue.submit.done`.

Target Deviation From Ideal Agent

New with 8.1.410.14. Select a variable to hold the result of calling the Universal Routing Server (URS) `TargetListSelected` function to calculate a value indicating an agent target's deviation from **ideal agent** to handle an interaction. When the property is assigned to a variable, Composer makes a call

to URS right after getting `queue.submit.done`:

```
'urs/call/@' + system.InteractionID + '/func/TargetListSelected?params=[]'
```

URS returns a string similar to the sample below:

```
return:ok|dn:7001|rdn:7001|switch:SIP_Switch|agent:KSippola|place:SIP_Server_Place1|
target_location:Stat_Server|stat_value:0|cost.type:X
```

If the **Set Ideal Agent block** is used before the Target block, the URS reply includes a mismatch key-value pair. The below sample was obtained with:

```
SetIdealAgent[Billing > 6</tt>] and the target with Skill <tt>Billing == 5</tt>).<br>
<pre>return:ok|dn:7001|rdn:7001|switch:SIP_Switch|agent:KSippola|place:SIP_Server_Place1|
target_location:Stat_Server|stat_value:0|mismatch:2|cost.type:X
```

In this sample, the Target Deviation From Ideal Agent variable is assigned the (integer) value (i.e., 2) of the mismatch key-value pair when available, undefined otherwise.

Target Object Selected Property

Select a variable containing the high-level target (one that you specify in a `<submit>`) to which the interaction was routed or should be routed to definitively. If a skill expression is used, the function returns: `?SkillExpression@statserver.GA` or even `?GroupName:SkillExpression@statserver.GA`. The target format is `Name@StatServerName.Type`. The selected variable will be updated with the target information after receiving a `queue.submit.done`.

Target Selected Property

Select a variable containing the DN and the switch name of the target to which the interaction was routed or should be routed to definitively. The target format is `Name@SwitchName.Type`. The selected variable will be updated with the target information after receiving a `queue.submit.done`.

Timeout Property

If not specified, validation generates an error.

If not specified, validation generates an error. Enter an integer to specify the time in seconds an interaction waits for an available target or keep the default of 10 (added starting with 8.1.440.18). If

the timeout expires before one of the targets is available, the interaction is routed to the error port (if the exception property is configured for the block).

Upon entering any Target block, if a target was not selected and at least one statistic is not open and waiting time is 0, URS adjusts waiting time to the maximum specified in URS options `reservation_pulling_time` and `treatment_delay_time` values. This eliminates the possibility of not routing the first call after URS is started.

Total Size Property

Select the variable to contain the total number of agents that can be targeted for the request. The selected variable will be populated with the respective output value obtained from the operations described in the [Expected Wait Time Property](#). You must have installed Universal Routing Server 8.1.3+.

Type Property

Use to define the type of redirection processing that is to be done. For more information and individual values, see the *Orchestration Server Developer's Guide* on the [Orchestration Server Wiki](#).

Use Access Code Property

Set to true to update the DN property of the resource reserved based on routing criteria to include the access code returned by URS. If true and the Route property is set to false, the resource object will still be modified even though the Target block will not route the call to the resource.

Use Access Code Setter Property

This property specifies the name of the function to use to update the resource with the returned access code. By default, this property points to the `updateDN(accesscode, dn)` function from `include/RouteFeature.js`. You can update the provided function so that all Target blocks that use this function benefit from the update. Or you can provide your own function to implement specific needs for a specific block.

Use Treatments Property

You can specify Busy treatments that will be executed while waiting for targets to become available. To enable Busy treatments, set this property to **true**. Busy treatments are similar to Mandatory

treatments that you can specify using individual **Voice Treatment** blocks.

This property provides instructions to Universal Routing Server for handling the interaction before an eligible target is available to receive it. Treatments (or Busys treatments) are played to callers while the call is waiting in a queue. You can specify any number of treatments for an interaction. The waiting interaction receives each treatment for the specified duration, in the specified order.

Any time that URS finds an available target for the call, the previously-started and currently-played busy treatment (and the entire Busy treatments chain) will be interrupted in favor of routing the call to a target. Target availability is checked upon starting a treatment, on updates from Stat Server, and usually every 2 seconds (the value of this time interval is configurable by the URS option `pulse_time`).

In order to specify treatments, this property must be set to **true**. Setting to true displays a new Busy treatments outport on the Target block. As shown below, **you can connect treatment blocks to this outport** that should be used for Busy treatments. Connect the last Busy treatment block back to its Target block. This indicates the completion of the Busy treatments loop.

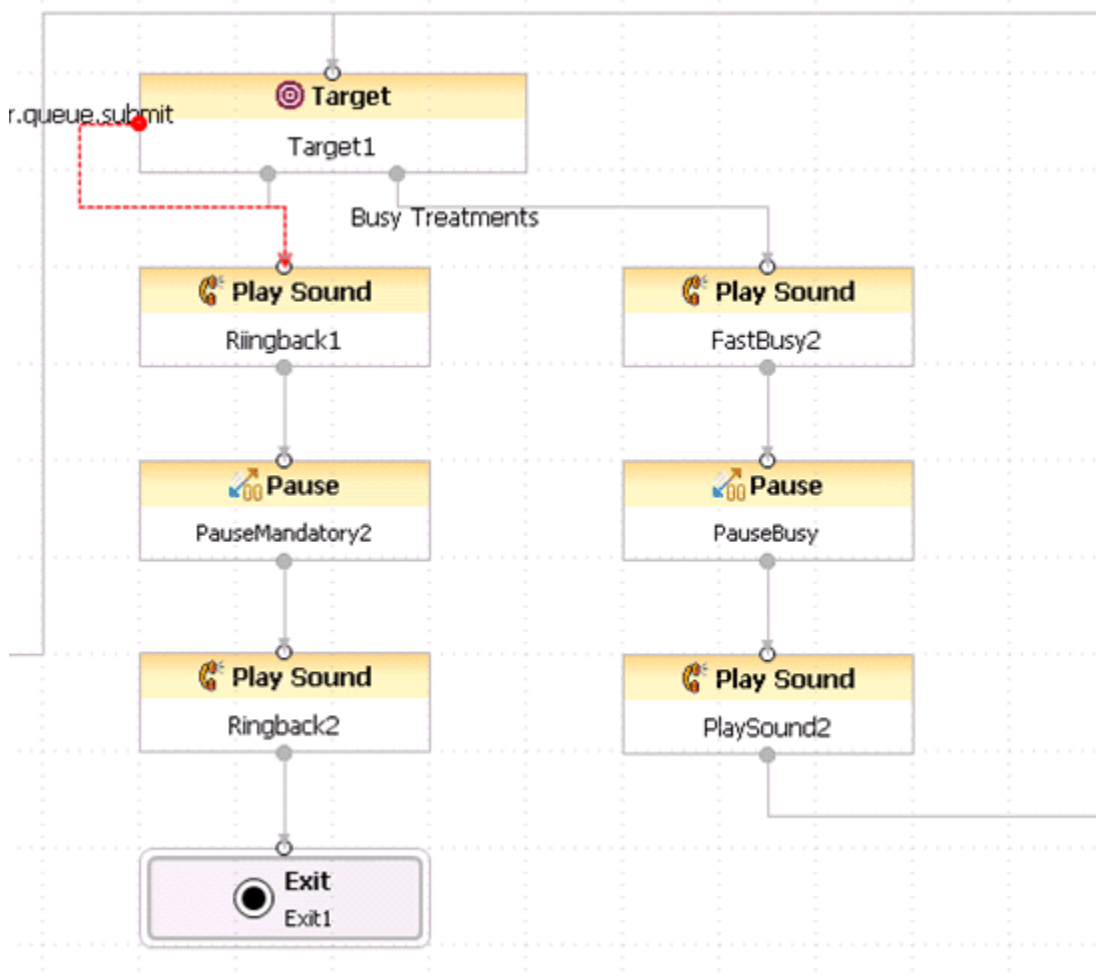



Important

Busy treatment blocks cannot handle exceptions or be used for exception handling. Diagram validation will check that the loop is completely correct and that only appropriate blocks are used for Busy treatments.

Virtual Queue Property

Use this property to define the enabled ACD virtual queue for the tenant. The virtual queue is not a physical queue but rather a logical queue to which interactions are queued if the specified targets are not available. Also see the [Virtual Queue Selected](#) property, which lets you select a variable. To define the virtual queue:

1. Opposite the Virtual Queue property, click under **Value** to display the  button.
2. Click the  button. The Virtual Queue dialog box opens.
3. Configuration Database are listed for selection. Select a queue.
4. Click **OK**.

Virtual Queue Selected Property

Select a variable containing a logical queue (Alias) to which interactions are queued if the specified targets are not available. Also see the [Virtual Queue](#) property below, which lets you specify the queue.

Creating Threshold Expressions

When using the Target block, Targets property, to define a threshold expression, there are two different cases:

- The threshold expression uses the function(s) `sdata`, `acfgdata`, `lcfgdata`. Composer converts the expression into a string. At runtime, ORS passes this string to URS. The expression must not contain variables as URS will **not** be able to evaluate them. For example:
`Threshold=sdata('agtgrp1.GA', 'StatAgentsAvailable') > 12`
- The threshold does not contain any occurrence of the `sdata`, `acfgdata`, `lcfgdata`. Composer included the expression as is in the generated SCXML and ORS will evaluate the expression before passing the result of that expression evaluation to URS. The expression may use variables. For example:

Threshold=myvar

The variable value may contain occurrences of sdata, acfgdata, lcfgdata functions. For example:

```
myvar="sdata('agtgrp1.GA', 'StatAgentsAvailable') > 12"
```

Or Threshold=var1 + var2 where var1="sdata('agtgrp1.GA', 'StatAgentsAvailable') > "
and var2="12"

See [Queue Interface Action Elements](#) for more detail.

Update Block

Use the Update block to update the criteria associated with an outstanding [submit](#) request. Can be used for both voice and multimedia interactions. For more information, see the *Orchestration Server Developer's Guide*, Queue Interface, [Action Elements](#), <update> Action Element.

Name Property

Find this property's details under [Common Properties](#).

Block Notes Property

Find this property's details under [Common Properties](#).

Condition Property

Find this property's details under [Common Properties](#).

Enable Status Property

Find this property's details under [Common Properties](#).

Logging Details Property

Find this property's details under [Common Properties](#).

Log Level Property

Find this property's details under [Common Properties](#).

Priority Property

To use this optional property, click the down arrow under Value and select the variable, which contains a value expression returning the current priority of the update request. For more information, see <http://www.w3.org/TR/scxml/#ValueExpressions>.

Request ID Property

Specify either:

- a variable holding the request ID of an outstanding queuing request;
- or a Target/Route Interaction block (Block Reference).

Timeout Property

Keep the default of 30 (added in 8.1.440.18), or enter a value to be used to update the routing timeout for the pending queuing request (the initial queueing timeout is usually specified using the [Target block Timeout property](#) or the [Route Interaction block Timeout property](#)). For more information, see the *Orchestration Server Developer's Guide*, Queue Interface, [Action Elements](#), <update> Action Element, timeout.

ORS Extensions Property

Starting with 8.1.4, Composer blocks used to build routing applications (with the exception of the Disconnect and EndParallel blocks) add a new [ORS Extensions](#) property.

Percent and Conditional Routing

You can also use the **Target Block** for:

- Percentage routing or for
- Conditional routing using the **threshold functions**

Percentage Routing

When using the **Target Block**, if percentage is selected for the **Statistics Order property**, the Targets dialog box, which opens from the **Targets property**, displays a Weight column as shown below.

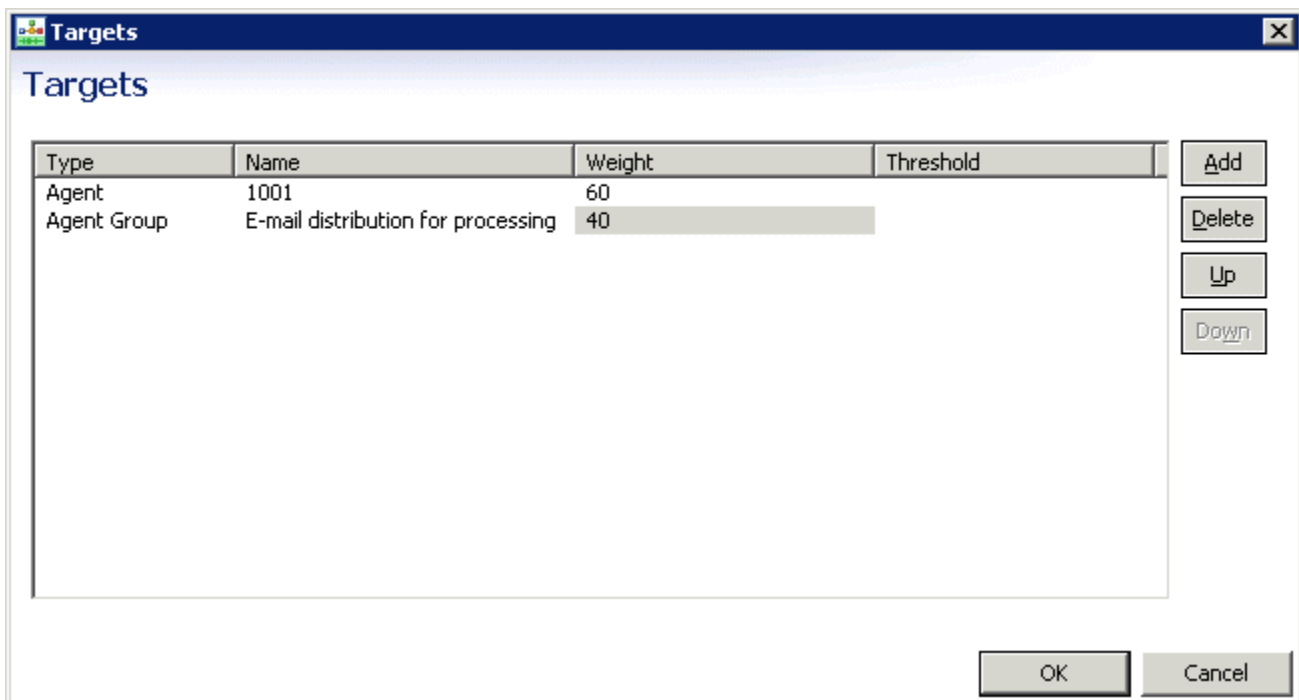

Here you can enter numbers to specify percentage allocation for each target.

Conditional Routing

Universal Routing Server's threshold functions can be used in the **Target block** for conditional routing, such as "share agents by service level agreement routing" as described in the *Universal Routing 8.1 Routing Application Configuration Guide*. The Targets dialog box, which opens from the **Targets property**, displays a Threshold column. Click the button under Threshold to open **Expression Builder**

where you can create a **threshold expression**.

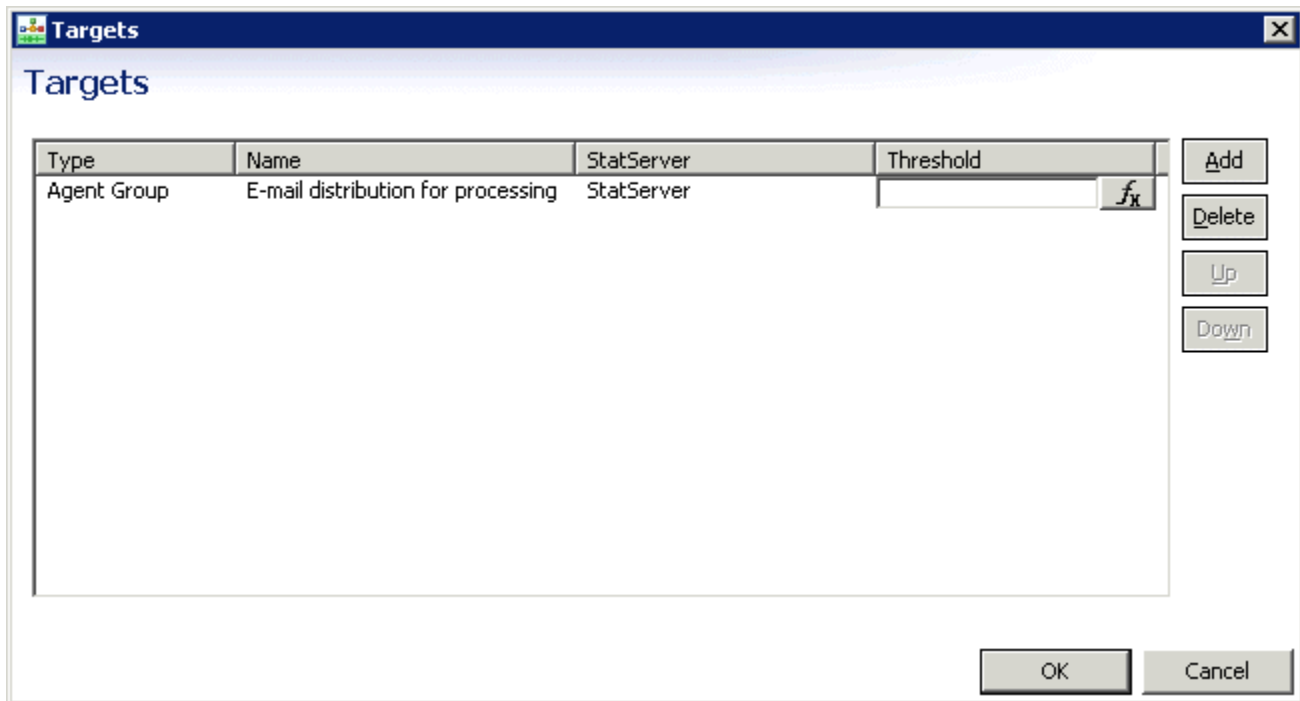

Routing to the Last Called Agent

Beginning with release 8.1.510.12, Composer supports routing interactions to the Last Called Agent (LCA), that is, the most recently contacted agent. This is supported for both voice and non-voice multimedia interactions through the Target block and the Route Interaction block respectively.

When a customer calls a contact center, the agent ID and call time are saved to the customer contact information in the UCS database. As a result, a future call from the customer can be routed to the same agent.

Important

The LastCalledAgent_EmployeeID and LCA_EmplID_voice customer profile attributes are persisted in the UCS database only if the Interaction Workspace option `contact.last-called-agent.<mediatype>.enable` is set to TRUE as described [here](#) and is applicable only for inbound and outbound calls, and not for internal calls.

To enable this functionality in Composer, a new target type, **LCA**, is added to the **Targets** dialog accessed through the **Targets** property in the Target block and the Route Interaction block.

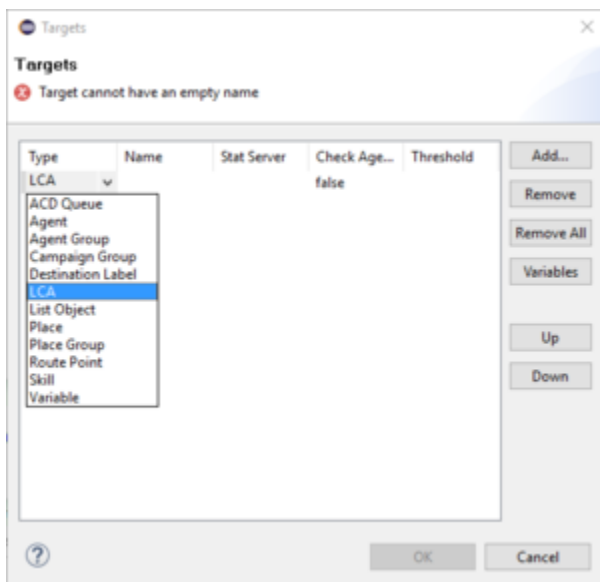

If the last called agent's details are known, users can optionally specify a variable in the Name column of the Target dialog to directly route to the agent. If no variable is selected in the **Name** column, the `<session:fetch>` action element is used to identify the customer, retrieve the agent information from the UCS database, and then route to the particular agent.

Important

The other options in the Targets dialog (**Stat Server**, **Check Agent Availability**, and **Threshold**) are not applicable for the LCA target type.

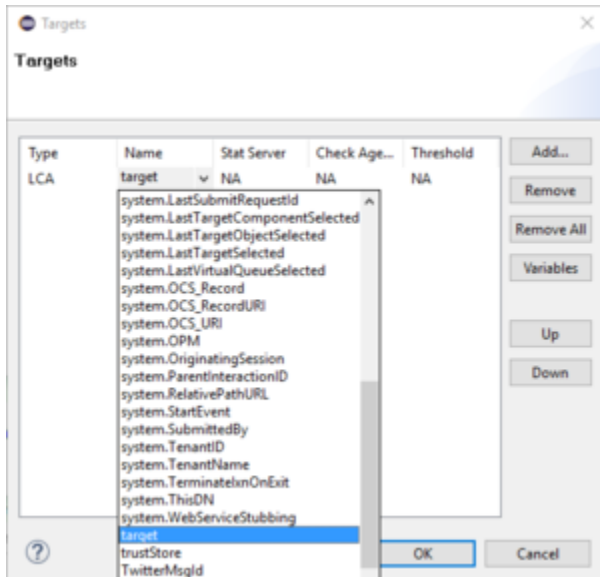

Important

When LCA is selected as the target type, a script is generated within the target state as part of code generation to retrieve the last called agent's ID from UCS and is used as the routing target. If the last called agent is not available, the other targets specified in the block are attempted.

Voice Treatment Blocks

Busy treatments can be played to callers when all the targets selected by URS are busy and the interaction is waiting for an available target. You can specify treatments using the blocks below or use the [UseTreatments](#) property.

Also see [Single Session Treatments](#).

Connecting to Busy Treatment Port

The following treatment blocks may be connected to the [Busy Treatments port of the Target block](#) and used as busy treatments: Play Application, Play Sound, Play Message, User Input, Set Default Route, Pause, Create User Announcement, Delete User Announcement, IVR, and Disconnect. This will enable you to see all defined busy treatments in the diagram as well as use the Properties view to configure busy treatments. The table below summarizes the voice treatment blocks.

Cancel Call	Use this block to stop a currently running dialog.
Create User Announcement	Use this block to record a caller announcement.
Delete User Announcement	Use this block delete an announcement created by a caller using the Create User Announcement block.
IVR	Use to invoke an interactive voice response (IVR) unit and connect the interaction to the IVR.
Pause	Use to suspend treatment processing for a specified duration.
Play Application	Use to execute an application (such as a Composer voice application) or a script on a device, such as an IVR.
Play Sound	Use to play audio resources of the following type: <ul style="list-style-type: none"> • Music • BusyTone • FastBusyTone • RingBack • RecordedAnnouncement (on Stream Manager) • Silence
Play Message	Use to invoke/play audio or text-to-speech Announcement treatments.
User Input	Use to play a text-to-speech announcement, collect digits, and (optionally) verify the input digits.

Set Default Route	Use to set/change the default route number at any time.

Composer Equivalent to IRD Treatment

Composer includes **treatment** functionality that was previously provided through Genesys Interaction Routing Designer (IRD). The information below is provided for existing Genesys customers transitioning to Composer, who are familiar with using IRD's Treatment objects. The **Composer Busy Treatment?** column specifies whether the treatment is supported as a busy treatment. If not, it is only supported as a mandatory treatment.

- Mandatory treatments are those to which an interaction will be subject whether there are any available targets or not.
- Busy treatments are applied when all the targets selected are busy and the interaction is waiting for an available target.

Composer Equivalent	Composer Busy Treatment?	IRD Treatment	SCXML Tags	Description
Create User Announcement	no	Record User Announcement	<dialog:createann>	Records an announcement from a user and associate it with a specific user.
Delete User Announcement	no	Delete User Announcement	<dialog:deleteann>	Deletes an announcement created by a caller using the Create User Announcement treatment.
Disconnect	no	Cancel Call	<dialog:stop>	Disconnect the caller and end the call.
IVR	yes	IVR	<dialog:remote>	Invokes an interactive voice response (IVR) unit and connect the interaction to the IVR.
Pause	yes	Pause	<send> (mandatory) <pause> (busy)	Suspends treatment processing for a specified duration.
Play Application	yes	Play application	dialog:start	Executes an application or script on the IP device. It is possible to pass parameters to the application and

				get return values.
Play Message	yes	Play announcement	dialog:play	Plays an announcement for the caller.
Play Message	yes	Text to speech	dialog:play <prompts type=tts>	Generates speech from text. No recorded announcements can be used.
Play Sound	yes	Busy	dialog:playsound type="busy"	Connects the interaction to the source of a busy tone. The caller hears a busy signal.
Play Sound	yes	Fast busy	dialog:playsound type="fastbusy"	Connects the interaction to the source of a different busy tone. The caller hears a fast busy signal. This treatment is supported on a limited number of switches.
Play Sound	yes	Music	dialog:playsound type="music"	Connects the interaction to a music source.
Play Sound	yes	Ringback	dialog:playsound type="ringback"	Connects the interaction to a ringback tone source.
Play Sound	yes	Silence	dialog:playsound type="silence"	Specifies an interval without sound.
Play Sound	yes	RAN	dialog:playsound type="ran"	Similar to the Music object. The source must be a RAN port on the switch. This treatment is supported by a limited number of switches.
Set Default Route	no	Set default destination	dialog: setdialogdefaultdest	Sets or changes the default destination.
User Input	yes	Play announcement and collect digits	dialog:playandcollect	Plays an announcement for the caller and requests that the

				caller provide information by inputting digits.
User Input	yes	Text to speech and collect digits	dialog:playandcollect	Generates speech from text and then requests input from the caller in the form of digits.
User Input	yes	Collect digits	dialog:collect	Collects digits that a caller enters. For example, you might collect an account number. Don't specify prompts in UserInput block. It will generate code for <dialog:collect>/
Digit verification in User Input	yes	Verify digits	<playandverify>	The IRD Verify Digits object prompts a caller to enter digits that will be compared to a desired response.

Cancel Call Block

Use this block to stop a currently running dialog. The Cancel Call block has the following properties:

Name Property

Find this property's details under [Common Properties](#).

Block Notes Property

Find this property's details under [Common Properties](#).

Exceptions Property

Find this property's details under [Common Properties](#).

Condition Property

Find this property's details under [Common Properties](#).

Logging Details Property

Find this property's details under [Common Properties](#).

Log Level Property

Find this property's details under [Common Properties](#).

Enable Status Property

Find this property's details under [Common Properties](#).

Device ID Property

If specified, ORS will play treatments itself; otherwise, treatment playing is delegated to URS. The device should specify the DN where the call is currently located. If the call is on multiple DNs, specify the DN for which the treatment will be applied. Users can enter a value or select any runtime variable from the dropdown.

Hints Property

This property is for future use by Orchestration Server. Its use will be described in various action elements reference in the Orchestration Server wiki.

Extensions Property

Select the variable to retrieve extensions data in event `dialog.stop.done` as described in the *Orchestration Developers Guide*, Orchestration Extensions, Dialog Log Interface section of the [Orchestration Server Documentation Wiki](#).

Request ID Property

Select the variable whose value is the ID of the previously started dialog-related action.

ORS Extensions Property

Starting with 8.1.4, Composer blocks used to build routing applications (with the exception of the Disconnect and EndParallel blocks) add a new **ORS Extensions** property.

Create User Announcement Block

Use this block to record a caller announcement. The treatment device returns an announcement ID (User ID property) for the newly created announcement, which the application can use later to trigger playback of the announcement in other treatment blocks that support playing prompts. The Create User Announcement block has the following properties:

Name Property

Find this property's details under [Common Properties](#).

Block Notes Property

Find this property's details under [Common Properties](#).

Exceptions Property

Find this property's details under [Common Properties](#).

Condition Property

Find this property's details under [Common Properties](#).

Logging Details Property

Find this property's details under [Common Properties](#).

Log Level Property

Find this property's details under [Common Properties](#).

Enable Status Property

Find this property's details under [Common Properties](#).

Device ID Property

If specified, ORS will play treatments itself; otherwise, treatment playing is delegated to URS. The device should specify the DN where the call is currently located. If the call is on multiple DNs, specify the DN for which the treatment will be applied. Users can enter a value or select any runtime variable from the dropdown.

Extensions Property

Select the variable to retrieve extensions data in event `dialog.createann.done` as described in the *Orchestration Developers Guide*, Orchestration Extensions, Dialog Log Interface section of the [Orchestration Server Documentation Wiki](#).

Hints Property

This property is for future use by Orchestration Server. Its use will be described in various action elements reference in the Orchestration Server wiki.

Interaction ID Property

Set to a meaningful value or keep the default value, which is the system variable `InteractionId`. Can be used for "interaction-less" processing for scenarios where the `InteractionId` variable is not automatically initialized, but instead must wait for an event. An example would be an SCXML application triggered by a Web Service that does not add an interaction. Background: Previous to 8.1.1, Composer did not expose an Interaction ID property. Instead, when ORS started processing an interaction, a generated SCXML application automatically initialized the system variable, `InteractionId`. This variable was then used internally by Routing and certain eServices blocks when interacting with ORS. With the introduction of support for Interaction-less processing, you can now define a specific event (**IPD** Wait For Event property) to initialize `InteractionId`, or not define an event at all. For scenarios with an interaction (**IPD** Diagram/Wait For Event=`interaction.present` for example), you may keep the default value for the Interaction ID property. The default value is the system variable `InteractionId`, which is initialized automatically in this case. For other scenarios (any scenario where the system variable `InteractionId` is not set), you may choose to:

1. Not use blocks that require an Interaction ID
2. And/or set the Interaction ID property to a meaningful value
3. And/or assign a meaningful value to the `InteractionId` system variable

Announcement ID Property

Select the variable (**Project or workflow**) that contains the identifier for the created announcement. This application variable may be used later in other blocks to work with the caller announcement created in this block. The Delete User Announcement block will accept this variable if you wish to delete this announcement.

Prompts Property

This property lets you define a series of elements (prompts), which are pieced together. Each prompt can be described as interruptible or non-interruptible.

1. Click the Prompts row in the block's property table.
2. Click the  button to open the Prompts dialog box.
3. Click **Add** to add a prompt.
4. Under Type, select one of the following:
 - **Announcement--Plays** an announcement to the calling party. In this case, the Value field contains a number of elements (from 1 to 10). Each element is named with a number ranging from 1 to 10 and contains a number of entries describing announcement elements. Announcement prompts do not have a user association.
 - **FormattedDigits**--Used to collect digits from the caller.
 - **Text**--Essentially the same as Announcement, except all elements are of type text. This option does not allow mixing recorded announcements with text-to-speech. Use when Announcement is not supported.
 - **User Announcement**-- Announcements with a user association previously created with the Create User Announcement block can be played via this type of prompt.
5. Under **Interruptible**, select true or false to indicate if the caller can interrupt the message .
6. Under **Value**, enter the prompt parameters.
7. Click **Add** again to enter another prompt, or click **OK** to finish.

Abort Digits Property

Select the variable to contain up to 2 digits that the caller can use to abort the recording process. If aborted, an error event is generated.

Reset Digits Property

Select the variable to contain a sequence of up to 2 digits that the caller can use to restart the

recording process and discard any recording made up to that point in this block will be discarded. This is not an error condition.

Start Timeout Property

Select the variable to contain the number of seconds that the routing platform should wait for the caller to start recording the announcement.

Termination Digits Property

Select the variable to contain a sequence of up to 2 digits that the caller can use to indicate the end of the recording process. This indicates a success case.

Total Timeout Property

Select the variable to contain the number of seconds for which the routing platform should wait for the caller to complete recording.

Request ID Property

Select the variable to hold the ID associated with the treatment request from the orchestration application or the resource.

Wait For Treatment End Property

Select true or false.

- If true, the transition to the next block occurs when the treatment is finished (or if a timeout occurs).
- If set to false, processing goes to the next block once the treatment is successfully started instead of waiting for the treatment to complete. The Request ID variable holds the ID of the treatment.

User ID Property

Select or enter the variable to contain the user identifier to be associated with this recording. This can be used to trigger playback of the recording in other treatment blocks that support playing prompts.

Important

You can also specify a path manually. But only relative paths (that is, relative to the directory that is configured for recordings) are supported for this property. For example, `file://RecordingFolder\2111`.

ORS Extensions Property

Starting with 8.1.4, Composer blocks used to build routing applications (with the exception of the Disconnect and EndParallel blocks) add a new **ORS Extensions** property.

Delete User Announcement Block

Use this block to delete an announcement created by a caller using the Create User Announcement block. The Delete User Announcement block has the following properties:

Name Property

Find this property's details under [Common Properties](#).

Block Notes Property

Find this property's details under [Common Properties](#).

Exceptions Property

Find this property's details under [Common Properties](#).

Device ID Property

If specified, ORS will play treatments itself; otherwise, treatment playing is delegated to URS. The device should specify the DN where the call is currently located. If the call is on multiple DNs, specify the DN for which the treatment will be applied. Users can enter a value or select any runtime variable from the dropdown.

Hints Property

This property is for future use by Orchestration Server. Its use will be described in various action elements reference in the Orchestration Server wiki.

Interaction ID Property

Set to a meaningful value or keep the default value, which is the system variable InteractionId. Can be used for "interaction-less" processing for scenarios where the InteractionId variable is not automatically initialized, but instead must wait for an event. An example would be an SCXML

application triggered by a Web Service that does not add an interaction. Background: Previous to 8.1.1, Composer did not expose an Interaction ID property. Instead, when ORS started processing an interaction, a generated SCXML application automatically initialized the system variable, InteractionId. This variable was then used internally by Routing and certain eServices blocks when interacting with ORS. With the introduction of support for Interaction-less processing, you can now define a specific event (IPD Wait For Event property) to initialize InteractionId, or not define an event at all. For scenarios with an interaction (IPD Diagram/Wait For Event=interaction.present for example), you may keep the default value for the Interaction ID property. The default value is the system variable InteractionId, which is initialized automatically in this case. For other scenarios (any scenario where the system variable InteractionId is not set), you may choose to:

1. Not use blocks that require an Interaction ID
2. And/or set the Interaction ID property to a meaningful value
3. And/or assign a meaningful value to the InteractionId system variable

Extensions Property

Select the variable to retrieve extensions data in event `dialog.deleteann.done` as described in the *Orchestration Developers Guide*, Orchestration Extensions, Dialog Log Interface section of the [Orchestration Server Documentation Wiki](#).

Announcement ID Property

Enter or select the variable to contain the identifier of the announcement to delete.

User ID Property

Select or enter a variable to contain the user identifier associated with the recording to be deleted.

ORS Extensions Property

Starting with 8.1.4, Composer blocks used to build routing applications (with the exception of the Disconnect and EndParallel blocks) add a new **ORS Extensions** property.

IVR Block

Use this treatment block to invoke an interactive voice response (IVR) unit and connect the interaction to the IVR. Specify the IVR in a format similar to that of a target because Universal Routing Server (URS) transfers the interaction in the same way as it would when routing to a target. The IVR produces a set of DNs from the source (corresponding to a target ID), location, type, and Stat Server information. If any of these DNs are available, it sends the interaction to one of them. Note: URS does not verify that the DN to which it sends the interaction is an IVR. It may be useful to send the interaction to a queue, which distributes it to the actual IVR. When specifying an IVR target:

- The IVR itself is often configured in Configuration Layer as a DN of type Voice Treatment Port, where Voice Treatment Option scripts can run.
- The most frequent configuration for using IVRs in a workflow involves creating a Place in Configuration Layer and creating a shortcut from the place to the IVR DN. Then IVRs can be used as treatments by specifying the Place or a Place Group that corresponds to an IVR.
- Another way to specify the IVR is to set the Compatibility Mode property to "true" and then manually enter the DN as a source and the name of the switch as the location (<DN>@<name of switch>) as the Remote Resource.

All voice treatments except IVR work at the switch or the intelligent peripheral. The IVR treatment is different from the other treatments because URS routes the interaction to an IVR, just as it does for a target. Therefore, the format used to specify the IVR treatment is similar to that for a target. The IVR block has the following properties:

Name Property

Find this property's details under [Common Properties](#).

Block Notes Property

Find this property's details under [Common Properties](#).

Exceptions Property

Find this property's details under [Common Properties](#).

Condition Property

Find this property's details under [Common Properties](#).

Logging Details Property

Find this property's details under [Common Properties](#).

Log Level Property

Find this property's details under [Common Properties](#).

Enable Status Property

Find this property's details under [Common Properties](#).

Device ID Property

If specified, ORS will play treatments itself; otherwise, treatment playing is delegated to URS. The device should specify the DN where the call is currently located. If the call is on multiple DNs, specify the DN for which the treatment will be applied. Users can enter a value or select any runtime variable from the dropdown.

Hints Property

This property is for future use by Orchestration Server. Its use will be described in various action elements reference in the Orchestration Server wiki.

Interaction ID Property

Set to a meaningful value or keep the default value, which is the system variable InteractionId. Can be used for "interaction-less" processing for scenarios where the InteractionId variable is not automatically initialized, but instead must wait for an event. An example would be an SCXML application triggered by a Web Service that does not add an interaction. Background: Previous to 8.1.1, Composer did not expose an Interaction ID property. Instead, when ORS started processing an interaction, a generated SCXML application automatically initialized the system variable, InteractionId. This variable was then used internally by Routing and certain eServices blocks when interacting with ORS. With the introduction of support for Interaction-less processing, you can now define a specific event using the **IPD Wait For Event property** to initialize InteractionId, or not define an event at all. For scenarios with an interaction (IPD Diagram/Wait For Event=interaction.present for example), you may keep the default value for the Interaction ID property. The default value is the system variable InteractionId, which is initialized automatically in this case. For other scenarios (any scenario where the system variable InteractionId is not set), you

may choose to:

1. Not use blocks that require an Interaction ID
2. And/or set the Interaction ID property to a meaningful value
3. And/or assign a meaningful value to the InteractionId system variable

Application Property

Select the variable to contain the identifier of the application that will be started by the specified remote resource as part of this treatment. Used only if the Compatibility Mode property = true.

Extensions Property

Select the variable to retrieve extensions data in event `dialog.remote.done` as described in the *Orchestration Developers Guide*, Orchestration Extensions, Dialog Log Interface section of the [Orchestration Server Documentation Wiki](#).

Compatibility Mode Property

Select true or false to control if IVR information is specified in a format compatible with how targets are specified in URS as described in the *Universal Routing 8.1 Reference Manual*. See the Remote Resource property for more information.

Failover Resource Property

Select the variable to contain the address of the resource to which this interaction will be routed in case there is an error in routing to the resource specified in the Remote Resource property. This resource would be used, for example, if the connection to T-Server is lost. The format of this value depends on the value of the Compatibility Mode property.

- If Compatibility Mode = true, the value must in the targeted format: 2323@www.genesys.com\server1.AG
- If Compatibility Mode = false, the value can be a string for the target resource in the format TargetName@StatServerName.TargetType as described in *Universal Routing 8.1 Reference Manual*, Chapter 2, Target Properties.

Remote Resource Property

Select the variable that contains the address of the remote resource that will be used to provide the treatment. The format of this value depends on the value of the Compatibility Mode property.

- If Compatibility Mode = true, the value must be in the format: DN.SWITCH (like 2323@switch_name) or
- If Compatibility Mode = false, the value can be a string for the target resource in the format: targetname@statsservername.targettype (like PlaceGroup@Ststserver.GP) as described in *Universal Routing 8.1 Reference Manual*, Chapter 2, Target Properties.

Treatment Duration Property

Enter the maximum duration in seconds for which this treatment can be executed. After this duration, the treatment is considered finished successfully by the platform. Limitation: It is not possible for the application to determine if the IVR treatment completed successfully or it was cut short once the treatment duration expired.

ORS Extensions Property

Starting with 8.1.4, Composer blocks used to build routing applications (with the exception of the Disconnect and EndParallel blocks) add a new **ORS Extensions** property.

Pause Block

Use this block to suspend treatment processing for a specified duration.

- If a treatment block other than the IVR block precedes the Pause block, that treatment continues for the duration of the Pause treatment.
- In the case of a preceding IVR treatment, the Pause treatment starts only after the interaction has been returned to the routing point. Then the caller hears nothing for the specified time interval.

The Pause block has the following properties:

Name Property

Find this property's details under [Common Properties](#).

Block Notes Property

Find this property's details under [Common Properties](#).

Exceptions Property

Find this property's details under [Common Properties](#).

Condition Property

Find this property's details under [Common Properties](#).

Logging Details Property

Find this property's details under [Common Properties](#).

Log Level Property

Find this property's details under [Common Properties](#).

Enable Status Property

Find this property's details under [Common Properties](#).

Duration Property

Enter a value or select the variable to contain the time in seconds for which treatment processing should be suspended. This property supports the following. Note: The example below uses Timeout.

- Literal integer value. For example: Timeout=4 & Unit=second <send event="'WaitEvent1.wait.timeout'" delay="'4s'"/>.
- Variable with integer value. For example: Timeout=Variable(4) & Unit=second <send event="'WaitEvent1.wait.timeout'" delay="'4s'"/>.
- Variable with string value. For example: Timeout=Variable('6') & Unit=second <send event="'WaitEvent1.wait.timeout'" delay="'6s'"/>.
- Variable with string value including unit. For example: Timeout=Variable('6ms') & Unit=second <send event="'WaitEvent1.wait.timeout'" delay="'6ms'"/>. In this case, the unit specified in the variable is used instead of the static property unit.

Unit Property

Click the down arrow and select either **second** or **millisecond**.

ORS Extensions Property

Starting with 8.1.4, Composer blocks used to build routing applications (with the exception of the Disconnect and EndParallel blocks) add a new [ORS Extensions](#) property.

Play Application Block

Use to execute an application (such as a Composer voice application) or a script on a device, such as an IVR.

- For URS-controlled applications where the call lands on the strategy first and then a VXML application is called using the Play Application treatment, **GVP** must be configured as DN type VoiceOverIP Service. Find detailed configuration instructions in Voice Platform Solution Integration Guide.
- **Debugging** a Play Application block will not step into the associated Callflow diagram and will not launch a GVP debugging sessions. Instead debugging will continue on to the block after the Play Application block.

Also see **Passing Parameters**. The Play Application block has the following properties:

Name Property

Find this property's details under **Common Properties**.

Block Notes Property

Find this property's details under **Common Properties**.

Exceptions Property

Find this property's details under **Common Properties**.

Condition Property

Find this property's details under **Common Properties**.

Logging Details Property

Find this property's details under **Common Properties**.

Log Level Property

Find this property's details under [Common Properties](#).

Enable Status Property

Find this property's details under [Common Properties](#).

Device ID Property

If specified, ORS will play treatments itself; otherwise, treatment playing is delegated to URS. The device should specify the DN where the call is currently located. If the call is on multiple DNs, specify the DN for which the treatment will be applied. Users can enter a value or select any runtime variable from the dropdown.

Hints Property

This property is for future use by Orchestration Server. Its use will be described in various action elements reference in the Orchestration Server wiki.

Interaction ID Property

Set to a meaningful value or keep the default value, which is the system variable InteractionId. Can be used for "interaction-less" processing for scenarios where the InteractionId variable is not automatically initialized, but instead must wait for an event. An example would be an SCXML application triggered by a Web Service that does not add an interaction. Background: Previous to 8.1.1, Composer did not expose an Interaction ID property. Instead, when ORS started processing an interaction, a generated SCXML application automatically initialized the system variable, InteractionId. This variable was then used internally by Routing and certain eServices blocks when interacting with ORS. With the introduction of support for Interaction-less processing, you can now define a specific event (**IPD** Wait For Event property) to initialize InteractionId, or not define an event at all. For scenarios with an interaction (IPD Diagram/Wait For Event=interaction.present for example), you may keep the default value for the Interaction ID property. The default value is the system variable InteractionId, which is initialized automatically in this case. For other scenarios (any scenario where the system variable InteractionId is not set), you may choose to:

1. Not use blocks that require an Interaction ID
2. And/or set the Interaction ID property to a meaningful value
3. And/or assign a meaningful value to the InteractionId system variable

Extensions Property

Select the variable to retrieve extensions data in event `dialog.start.done` as described in the *Orchestration Developers Guide*, *Orchestration Extensions*, *Dialog Log Interface* section of the [Orchestration Server Wiki](#).

Language Property

To set the active language:

1. Select the Language row in the block's property table.
2. Click under Value to display a down arrow.
3. Select one of the following languages:

- **English (US)**
- **Spanish**
- **Mandarin**
- **Cantonese**
- **Vietnamese**
- **French**
- **French (Canada)**
- **German**
- **Italian**
- **Japanese**
- **Korean**
- **Russian**

Parameters Property

If the **Type** property is not URL, use the Parameters property to specify any treatment parameters:

1. Click the **Parameters** row in the block's property table.
2. Click the  button to open the Input and Output Parameter Sync dialog box.
3. Click **Add** to add a treatment parameter.
4. Under **Parameter Name**, accept the default name or change it.
5. From the **Parameter Type** drop-down list, select input.

Note: If the Type property is set to **ProjectFile**, the dialog box shows only input variables as Composer validates against the specified callflow.

6. Under **Value**, select from among the **variables** shown.
7. Under **Definition**, type a description for this parameter.
8. Click **Add** again to enter another parameter, or click **OK** to finish.

To delete a parameter, select an entry from the list and click **Delete**. Also see the [Passing Parameters](#) section below. **Next Generation Interpreter (NGI) Change** In 8.1 and prior releases, a parameter in the SIP Request URI was exposed as a VoiceXML session variable as follows:

- Request URI: sip:dialog@host;ParameterA=ValueA
- Session Variable: session.connection.protocol.sip.requesturi['ParameterA'] (Note: The case is preserved)

Starting from 8.1.1, the parameter name will be converted to lowercase in the session variable's array index. Example:

- Request URI: sip:dialog@host;ParameterA=ValueA
- Session Variable: session.connection.protocol.sip.requesturi['parametera'] (Note: The index has to be lowercase.)

Any parameters set in the Play Application block will be accessed in NGI with the parameter name in all lowercase.

Resource Property

Use to specify the treatment resource.

1. Click under **Value**.
2. The Resource property works with the Type property.
 - If **URL** or **Id** is the selected Type, clicking under Value displays a down arrow. Click the down arrow and select a **variable**. For GVP applications, the variable must contain the full URI of the VXML page.
 - If **ProjectFile** is the selected Type, clicking under Value displays the  button. Click to open a dialog box where you can select the Project file/callflow for the treatment application. Integration with voice callflows is provided so it is possible to select a callflow diagram file as the project file. In this case, Composer will automatically substitute the actual URL of the page at the time of Code Generation.

Type Property

Identifies the type of Resource.

1. Click under **Value** to display a down arrow.
2. Select one of the following types:
 - **URL**--Indicates that the Resource is a .vxml file and not a callflow. Composer currently does not parse this .vxml file so the Input and Output Parameter Sync dialog box described under the Parameters property does not open.
 - **ProjectFile**--Indicates that the Resource is a callflow.
 - **Id**--Indicates the ScriptID parameter as described in the *Genesys Voice Platform 8.1 Reference Help* (see Sample VoiceXML Applications > CTI Interactions > Treatments (Post Initiate Transfer) > Play Application topic). The Play Application treatment is invoked without APP_URL specified in the strategy.

Use User Data Property

When set to true, Composer will automatically update the interaction's **User Data** with the input/inout parameters specified in the Parameters property. Similarly, Composer will automatically read the interaction's User Data and update corresponding variables for every inout/output parameter specified in the Parameters property. Uses to avoid the procedure described in the **Passing Parameters** property description.

Request ID Property

Select the variable to hold the ID associated with the treatment request from the orchestration application or the resource.

Wait For Treatment End Property

Select **true** or **false**.

- If true, the transition to the next block occurs when the treatment is finished (or if a timeout occurs).
- If set to false, processing goes to the next block once the treatment is successfully started instead of waiting for the treatment to complete. The Request ID variable holds the ID of the treatment.

ORS Extensions Property

Starting with 8.1.4, Composer blocks used to build routing applications (with the exception of the Disconnect and EndParallel blocks) add a new **ORS Extensions** property.

Passing Parameters

To pass parameters from a workflow to a callflow that is being invoked with the Play Application block, follow these steps: Note: Step 2. below is required only for SIPS and is not mandatory for CTIC flow cases.

1. Create a variable of type Input in the Variables property of the callflow's Entry block. The variable name must be all lowercase.
2. At a point before the Play Application block in the workflow, add an **ECMAScript** block with the following script contents:

```
var input = new Object(); input.xyz = _data.VariableToPass; _genesys.ixn.setuData(input); xyz should match the variable name that you created in step 1. You can replace _data.VariableToPass with any variable, or a literal value, such as a string or number.
```

3. In the callflow, access the value using the variable that was created in step 1. Its value will be set automatically to the value specified in the ECMAScript block at the beginning of the callflow. Its value will be set at the beginning of the callflow to the value specified in the ECMAScript block in the workflow.

To pass parameters from a callflow (invoked from a Play Application block) back to the workflow, follow these steps:

1. Create a variable of type User in the Variables property of the callflow's Entry block. The variable name must be all lowercase.
2. In the callflow, use this variable to store any value that you want to pass back to the workflow.
3. In the callflow's Exit block, specify the variable as a return value.
4. In the workflow, after the Play Application block, the value will be available in the workflow variable `_genesys.ixn.interactions[ixnid].udata.xyz`, where xyz matches the name of the variable created in step 1.

Single Session Treatments

When using the Play Application, Play Sound (Music and ARM Types) Exit, and Disconnect blocks, voice applications can now optionally use a single VXML session on Media Control Platform to play/run multiple treatments instead of using one session per treatment. This enables DTMF buffering between multiple MSML treatments. For more information, see [Single Session Treatments](#).

Play Sound Block

Use to play audio resources of the following types:

- Music
- BusyTone
- FastBusyTone
- RingBack
- RecordedAnnouncement (on Stream Manager)
- Silence
- ARM

The Play Sound block has the following properties:

Name Property

Find this property's details under [Common Properties](#).

Block Notes Property

Find this property's details under [Common Properties](#).

Exceptions Property

Find this property's details under [Common Properties](#).

Condition Property

Find this property's details under [Common Properties](#).

Logging Details Property

Find this property's details under [Common Properties](#).

Log Level Property

Find this property's details under [Common Properties](#).

Enable Status Property

Find this property's details under [Common Properties](#).

Device ID Property

If specified, ORS will play treatments itself; otherwise, treatment playing is delegated to URS. The device should specify the DN where the call is currently located. If the call is on multiple DNs, specify the DN for which the treatment will be applied. Users can enter a value or select any runtime variable from the dropdown.

Hints Property

This property is for future use by Orchestration Server. Its use will be described in various action elements reference in the Orchestration Server wiki.

Interaction ID Property

Set to a meaningful value or keep the default value, which is the system variable InteractionId. Can be used for "interaction-less" processing for scenarios where the InteractionId variable is not automatically initialized, but instead must wait for an event. An example would be an SCXML application triggered by a Web Service that does not add an interaction. Background: Previous to 8.1.1, Composer did not expose an Interaction ID property. Instead, when ORS started processing an interaction, a generated SCXML application automatically initialized the system variable, InteractionId. This variable was then used internally by Routing and certain eServices blocks when interacting with ORS. With the introduction of support for Interaction-less processing, you can now define a specific event ([Event property](#)) to initialize InteractionId, or not define an event at all. For scenarios with an interaction (IPD Diagram/Events=interaction.present for example), you may keep the default value for the Interaction ID property. The default value is the system variable InteractionId, which is initialized automatically in this case. For other scenarios (any scenario where the system variable InteractionId is not set), you may choose to:

1. Not use blocks that require an Interaction ID
2. And/or set the Interaction ID property to a meaningful value
3. And/or assign a meaningful value to the InteractionId system variable

Find this property's details under [Common Properties](#).

Extensions Property

Select the variable to retrieve extensions data in event `dialog.playsound.done` as described in the *Orchestration Developers Guide*, Orchestration Extensions, Dialog Log Interface section of the [Orchestration Server Wiki](#).

Duration Property

The time, in seconds, that the treatment is applied.

Music Repeat Count

Use this property to specify the number of times an audio file is to be played. If no repetition is specified, the audio file continuously loops. To specify this behavior, the default is set to -1.

Important

If the ARM sound type is chosen and both **Duration** and **Music Repeat Count** are specified, **Duration** takes precedence over **Music Repeat Count**.

Resource Property

Specify the location of the sound resource. Testing will be done against Genesys Stream Manager, a media server that generates and processes media streams in Real-time Transport Protocol (RTP) format. For more information on Stream Manager, start with the *Framework 7.6 Stream Manager Deployment Guide*. You will need to configure [special DNS](#) for these treatments in Configuration Server.

Sound Type Property

Identifies the type of sound.

1. Click under **Value** to display a down arrow.
2. Select one of the following types:
 - **Music**
 - **BusyTone**

- **FastBusyTone**
- **Ringback**
- **Recorded Announcement**
- **Silence**
- **ARM**

ORS Extensions Property

Starting with 8.1.4, Composer blocks used to build routing applications (with the exception of the Disconnect and EndParallel blocks) add a new **ORS Extensions** property.

Single Session Treatments

When using the Play Application, Play Sound (Music and ARM Types) Exit, and Disconnect blocks, voice applications can now optionally use a single VXML session on Media Control Platform to play/run multiple treatments instead of using one session per treatment. This enables DTMF buffering between multiple MSML treatments. For more information, see [Single Session Treatments](#).

Play Message Block

Use to invoke/play audio or text-to-speech Announcement treatments. As described in the [Genesys Voice Platform Deployment Guide](#). GVP supports automatic speech recognition (ASR) and speech synthesis (text-to-speech [TTS]) as part of a VoiceXML dialog, through supported third-party ASR and TTS engines that use open standards. The Play Message block has the following properties:

Name Property

Find this property's details under [Common Properties](#).

Block Notes Property

Find this property's details under [Common Properties](#).

Exceptions Property

Find this property's details under [Common Properties](#).

Condition Property

Find this property's details under [Common Properties](#).

Logging Details Property

Find this property's details under [Common Properties](#).

Log Level Property

Find this property's details under [Common Properties](#).

Enable Status Property

Find this property's details under [Common Properties](#).

Device ID Property

If specified, ORS will play treatments itself; otherwise, treatment playing is delegated to URS. The device should specify the DN where the call is currently located. If the call is on multiple DNs, specify the DN for which the treatment will be applied. Users can enter a value or select any runtime variable from the dropdown.

Hints Property

This property is for future use by Orchestration Server. Its use will be described in various action elements reference in the Orchestration Server wiki.

Interaction ID Property

Set to a meaningful value or keep the default value, which is the system variable `InteractionId`. Can be used for "interaction-less" processing for scenarios where the `InteractionId` variable is not automatically initialized, but instead must wait for an event. An example would be an SCXML application triggered by a Web Service that does not add an interaction. Background: Previous to 8.1.1, Composer did not expose an `InteractionId` property. Instead, when ORS started processing an interaction, a generated SCXML application automatically initialized the system variable, `InteractionId`. This variable was then used internally by Routing and certain eServices blocks when interacting with ORS. With the introduction of support for Interaction-less processing, you can now define a specific event to initialize `InteractionId`, or not define an event at all. For scenarios with an interaction (IPD Diagram/Event=`interaction.present` for example), you may keep the default value for the `InteractionId` property. The default value is the system variable `InteractionId`, which is initialized automatically in this case. For other scenarios (any scenario where the system variable `InteractionId` is not set), you may choose to:

- Not use blocks that require an Interaction ID
- And/or set the Interaction ID property to a meaningful value
- And/or assign a meaningful value to the `InteractionId` system variable

Extensions Property

Select the variable to retrieve extensions data in event `dialog.play.done` as described in the *Orchestration Developers Guide*, Orchestration Extensions, Dialog Log Interface section of the [Orchestration Server Wiki](#).

Language Property

To set the active language:

1. Select the Language row in the block's property table.
2. Click under Value to display a down arrow.
3. Select one of the following languages:

- English (US)
- Spanish
- Mandarin
- Cantonese
- Vietnamese
- French
- French (Canada)
- German
- Italian
- Japanese
- Korean
- Russian

Prompts Property

This property lets you define of a series of elements (prompts), which are pieced together. Each prompt can be described as interruptible or non-interruptible.

1. Click the Prompts row in the block's property table.
2. Click the  button to open the Prompts dialog box.
3. Click **Add** to add a prompt.
4. Under **Type**, select one of the following:
 - **Announcement**--Plays an announcement to the calling party. In this case, the Value field contains a number of elements (from 1 to 10). Each element is named with a number ranging from 1 to 10 and contains a number of entries describing announcement elements.
 - **FormattedDigits**--Used to collect digits from the caller.
 - **Text**--Essentially the same as Announcement, except all elements are of type text. This option does not allow mixing recorded announcements with text-to-speech. Use when Announcement is not supported.
 - **User Announcement**--Announcements with a user association previously created with the

Create User Announcement block can be played via this type of prompt.

5. Under **Interruptible**, select **true** or **false** to indicate if the caller can interrupt the message .
6. Under **Value**, select the variable containing the prompt parameters.
7. Starting with Composer 8.1.410.14, a **Userid** column is introduced. It is enabled when you select Type as Userannouncement. You can select a variable or enter a literal. This is the GVP UserID, which can be used in conjunction with userannid to provide the context for interpreting the userannid (often the Tenant name).
8. Click **Add** again to enter another prompt, or click **OK** to finish.

Type of Prompts Property

Click the down arrow and select Announcement or Text-To-Speech.

Request ID Property

Select the variable to hold the ID associated with the treatment request from the orchestration application or the resource.

Wait For Treatment End Property

Select **true** or **false**.

- If true, the transition to the next block occurs when the treatment is finished (or if a timeout occurs).
- If set to false, processing goes to the next block once the treatment is successfully started instead of waiting for the treatment to complete. The Request ID variable holds the ID of the treatment.

ORS Extensions Property

Starting with 8.1.4, Composer blocks used to build routing applications (with the exception of the Disconnect and EndParallel blocks) add a new **ORS Extensions** property.

Set Default Route

Use this block to set/change the default route number at any time. Can override the default destination set by the [Default Routing](#) block. Once set, this will be applicable for the entire duration of the strategy unless overridden by another Set Default Route block in the workflow execution.

The Set Default Route block has the following properties:

Name Property

Find this property's details under [Common Properties](#).

Block Notes Property

Find this property's details under [Common Properties](#).

Exceptions Property

Find this property's details under [Common Properties](#).

Condition Property

Find this property's details under [Common Properties](#).

Logging Details Property

Find this property's details under [Common Properties](#).

Log Level Property

Find this property's details under [Common Properties](#).

Enable Status Property

Find this property's details under [Common Properties](#).

Destination Property

Enter the DN number for the default destination.

Device ID Property

If specified, ORS will play treatments itself; otherwise, treatment playing is delegated to URS. The device should specify the DN where the call is currently located. If the call is on multiple DNs, specify the DN for which the treatment will be applied.

Users can enter a value or select any runtime variable from the dropdown.

Hints Property

This property is for future use by Orchestration Server. Its use will be described in various action elements reference in the Orchestration Server wiki

Extensions Property

Select the variable to retrieve extensions data in `dialog.setdialogdefaultdest.done` as described in the *Orchestration Developers Guide*, Orchestration Extensions, Dialog Log Interface section of the [Orchestration Server Wiki](#).

ORS Extensions Property

Starting with 8.1.4, Composer blocks used to build routing applications (with the exception of the Disconnect and EndParallel blocks) add a new [ORS Extensions](#) property.

User Input Block

Use to play a text-to-speech announcement, collect digits, and (optionally) verify the input digits. The User Input block has the following properties.

Name Property

Find this property's details under [Common Properties](#).

Block Notes Property

Find this property's details under [Common Properties](#).

Exceptions Property

Find this property's details under [Common Properties](#).

Condition Property

Find this property's details under [Common Properties](#).

Logging Details Property

Find this property's details under [Common Properties](#).

Log Level Property

Find this property's details under [Common Properties](#).

Enable Status Property

Find this property's details under [Common Properties](#).

Device ID Property

If specified, ORS will play treatments itself; otherwise, treatment playing is delegated to URS. The device should specify the DN where the call is currently located. If the call is on multiple DNs, specify the DN for which the treatment will be applied. Users can enter a value or select any runtime variable from the dropdown.

Hints Property

This property is for future use by Orchestration Server. Its use will be described in various action elements reference in the Orchestration Server wiki.

Abort Digits Property

Select the variable to contain a sequence of up to two keys that the caller can enter to abort the recording process. The IP considers this as a failed recording attempt.

Backspace Digits Property

Select the variable to contain a sequence of up to two keys causing the previous keystroke to be discarded.

Ignore Digits Property

Select the variable to contain a sequence of up to two keys to be treated as though the keys have not been pressed.

Reset Digits Property

Select the variable to contain a sequence of up to two keys causing all the previous keystrokes to be discarded. The digit collection resumes.

Termination Digits Property

Select the variable to contain a sequence of up to two keys causing all the digits, not including the TERM_DIGITS, to be returned to the service logic as collected digits.

Language Property

To set the active language:

1. Select the Language row in the block's property table.
2. Click under Value to display a down arrow.
3. Select one of the following languages:

- **English (US)**
- **Spanish**
- **Mandarin**
- **Cantonese**
- **Vietnamese**
- **French**
- **French (Canada)**
- **German**
- **Italian**
- **Japanese**
- **Korean**
- **Russian**

Prompts Property

This property lets you define of a series of elements (prompts), which are pieced together. Each prompt can be described as interruptible or non-interruptible.

1. Click the **Prompts** row in the block's property table.
2. Click the  button to open the Prompts dialog box.
3. Click **Add** to add a prompt.
4. Under **Type**, select one of the following:
 - **Announcement**--Plays an announcement to the calling party. In this case, the Value field contains a number of elements (from 1 to 10). Each element is named with a number ranging

from 1 to 10 and contains a number of entries describing announcement elements.

- **FormattedDigits**--Used to collect digits from the caller. Starting with Composer 8.1.410.14, a **Userid** column is introduced. It is enabled when you select Type as Userannouncement. You can select a variable or enter a literal. This is the GVP UserID, which can be used in conjunction with userannid to provide the context for interpreting the userannid (often the Tenant name).
- **Text**--Essentially the same as Recorded Announcement, except all elements are of type text. This option does not allow mixing recorded announcements with text-to-speech. Use when RecordedAnnouncement is not supported.
- **User Announcement**--Announcements with a user association previously created with the Create User Announcement block can be played via this type of prompt.

5. Under **Interruptible**, select true or false to indicate if the caller can interrupt the message .
6. Under **Value**, enter the prompt parameters.
7. Click **Add** again to enter another prompt, or click OK to finish.

Timeout Prompts Property

This property defines the list of prompts to be played to the caller if a timeout occurs while waiting for input.

1. Click the  button to open the Timeout Prompts dialog box.
2. Click **Add** to add a prompt.
3. Under **Type**, select one of the following:
 - **Announcement**--Plays an announcement to the calling party. In this case, the Value field contains a number of elements (from 1 to 10. Each element is named with a number ranging from 1 to 10 and contains a number of entries describing announcement elements. Starting with Composer 8.1.410.14, a **Userid** column is introduced. It is enabled when you select **Type** as Userannouncement. You can select a variable or enter a literal. This is the GVP UserID, which can be used in conjunction with userannid to provide the context for interpreting the userannid (often the Tenant name).
 - **FormattedDigits**--Used to collect digits from the caller.
 - **Text**--Essentially the same as Recorded Announcement, except all elements are of type text. This option does not allow mixing recorded announcements with text-to-speech. Use when RecordedAnnouncement is not supported.
 - **User Announcement**--Announcements with a user association previously created with the Create User Announcement block can be played via this type of prompt.
4. Under **Interruptible**, select true or false to indicate if the caller can interrupt the message .
5. Under **Value**, enter the prompt parameters.
6. Click **Add** again to enter another prompt, or click OK to finish.

Type of Prompts Property

Select one of the following:

- **Announcement**
- **Text-to-Speech**

Clear Input Property

Use this property to indicate whether any information that has been input should be cleared before digit collection starts. Select **true** or **false**.

Digit Timeout Property

Select the variable to contain the number of seconds the IP should wait between DTMF digits.

Number of Digits Property

Select the variable to contain the number of digits to be collected. The maximum number of digits that can be collected is 31. The maximum number of digits can be equal to 0. In this case, no time is spent waiting for the caller to input digits, and a response is returned indicating 0 digits collected. The standard does not specify whether the response should contain a success or a failure indication, so expect an undefined behavior.

Start Timeout Property

Select the variable to contain the number of seconds the IP should wait for the caller to begin DTMF input.

Total Timeout Property

Select the variable to contain the total number of seconds the IP should wait for the caller to provide the requested DTMF input.

Verify Input Property

This property determines if the User Input block should also verify the collected input against a set of specified digits. If set to true, digits verification will be enabled and will allow for multiple attempts.

- If set to **true**, will generate <dialog:playandverify>.
- If set to **false**, block will generate <dialog:playandcollect>.

Collected Digits Variable Property

Select the variable to contain the collected digits.

Extensions Property

Select the variable to retrieve extensions data in `dialog.collect.done`, `dialog.playandcollect.done`, `dialog.playandverify.done` as described in the *Orchestration Developers Guide*, Orchestration Extensions, Dialog Log Interface section of the [Orchestration Server wiki](#).

Request ID Property

Select the variable to hold the ID associated with the treatment request from the orchestration application or the resource.

Wait For Treatment End Property

Select **true** or **false**.

- If true, the transition to the next block occurs when the treatment is finished (or if a timeout occurs).
- If set to false, processing goes to the next block once the treatment is successfully started instead of waiting for the treatment to complete. The Request ID variable holds the ID of the treatment.

Failure Prompts Property

This property defines the prompts to be played to the caller if input verification against the specified digits fails.

1. Click the **Failure Prompts** row in the block's property table.
2. Click the  button to open the Prompts dialog box.
3. Click **Add** to add a prompt.
4. Under **Type**, select one of the following:
 - **Announcement**--Plays an announcement to the calling party. In this case, use the Value field to specify the prompt elements (can be up to 10). Each element is named with a number ranging from 1 to 10 and contains a number of entries describing the announcement elements. Announcement prompts do not have a user association. Starting with Composer 8.1.410.14, a **Userid** column is introduced. It is enabled when you select **Type** as Userannouncement. You can select a variable or enter a literal. This is the GVP UserID, which can be used in conjunction with userannid to provide the context for interpreting the userannid (often the Tenant name).
 - **FormattedDigits**--Used to collect digits from the caller.
 - **Text**--Essentially the same as Announcement, except all elements are of type text. This option does not allow mixing recorded announcements with text-to-speech. Use when Announcement is not supported.
 - **User Announcement**--Announcements with a user association previously created with the Create User Announcement block can be played via this type of prompt.
5. Under **Interruptible**, select true or false to indicate if the caller can interrupt the message .
6. Under **Value**, enter the prompt parameters.
7. Click **Add** again to enter another prompt, or click OK to finish.

Retry Prompts Property

This property defines prompts to be played to the caller if input verification against specified digits fails.

1. Click the **Retry Prompts** row in the block's property table.
- Click the  button to open the Prompts dialog box.
 - Click **Add** to add a prompt.
 - Under **Type**, select one of the following:
 - **Announcement**--Plays an announcement to the calling party. In this case, use the Value field to specify the prompt elements (can be up to 10). Each element is named with a number ranging from 1 to 10 and contains a number of entries describing the announcement elements. Announcement prompts do not have a user association. Starting with Composer 8.1.410.14, a **Userid** column is introduced. It is enabled when you select **Type** as Userannouncement. You can select a variable or enter a literal. This is the GVP UserID, which can be used in conjunction with userannid to provide the context for interpreting the userannid (often the Tenant name).
 - **FormattedDigits**--Used to collect digits from the caller.

- **Text**--Essentially the same as Announcement, except all elements are of type text. This option does not allow mixing recorded announcements with text-to-speech. Use when Announcement is not supported.
 - **User Announcement**--Announcements with a user association previously created with the Create User Announcement block can be played via this type of prompt.
5. Under **Interruptible**, select true or false to indicate if the caller can interrupt the message .
 6. Under Value, enter the prompt parameters.
 7. Click **Add** again to enter another prompt, or click OK to finish.

Success Prompts Property

This property defines this list of prompts to be played to the caller if input is successfully verified against specified digits.

1. Click the **Success Prompts** row in the block's property table.
2. Click the  button to open the Prompts dialog box.
3. Click **Add** to add a prompt.
4. Under **Type**, select one of the following:
 - **Announcement**--Plays an announcement to the calling party. In this case, use the Value field to specify the prompt elements (can be up to 10). Each element is named with a number ranging from 1 to 10 and contains a number of entries describing the announcement elements. Announcement prompts do not have a user association. Starting with Composer 8.1.410.14, a **Userid** column is introduced. It is enabled when you select **Type** as Userannouncement. You can select a variable or enter a literal. This is the GVP UserID, which can be used in conjunction with userannid to provide the context for interpreting the userannid (often the Tenant name).
 - **FormattedDigits**--Used to collect digits from the caller.
 - **Text**--Essentially the same as Announcement, except all elements are of type text. This option does not allow mixing recorded announcements with text-to-speech. Use when Announcement is not supported.
 - **User Announcement**--Announcements with a user association previously created with the Create User Announcement block can be played via this type of prompt.
5. Under **Interruptible**, select true or false to indicate if the caller can interrupt the message .
6. Under **Value**, enter the prompt parameters.
7. Click **Add** again to enter another prompt, or click **OK** to finish.

Dtmf Verification Option Property

This attribute determines which verification scheme is used. Select one of the following:

- **Compare Digits**--Input is compared against specified digits.
- **Local Table**--Lookup Local table indexing associated with a user id.
- **Compare Dialing Plan Format**--Format compliance with a specified dialing plan.

Verification Attempts Property

Select the variable to contain the number that determine the number of attempts to be made for verifying collected digits.

Verification Data Property

Select the variable to contain the verification data. This property determines what the input digits are compared against.

ORS Extensions Property

Starting with 8.1.4, Composer blocks used to build routing applications (with the exception of the Disconnect and EndParallel blocks) add a new **ORS Extensions** property.

Single Session Treatments

Starting with Composer 8.1.300.78, Composer supports ORS-centric GVP single-session treatments. When using the Play Application, Play Sound (Music and ARM Types) Exit, and Disconnect blocks, voice applications can now optionally use a single VXML session on Media Control Platform to play/run multiple treatments instead of using one session per treatment. This enables DTMF buffering between multiple MSML treatments.

ComposerPlayTreatments VXML File

A static master VXML page, located in the src directory, is used for playing treatments in one GVP session: (`ComposerPlayTreatments.vxml`). Treatment URLs to play can be Composer diagram-generated VXML file, Media Control Platform built-in treatments or third party sub-dialog URLs. The `ORSSessionID` will be provided as initial Play Application input parameters; successive HTTP requests can pass treatment input parameters. Treatment execution results and return results will be passed back to the ORS session.

Orchestration Options Dialog Box

The Orchestration Options dialog box is used for this functionality.

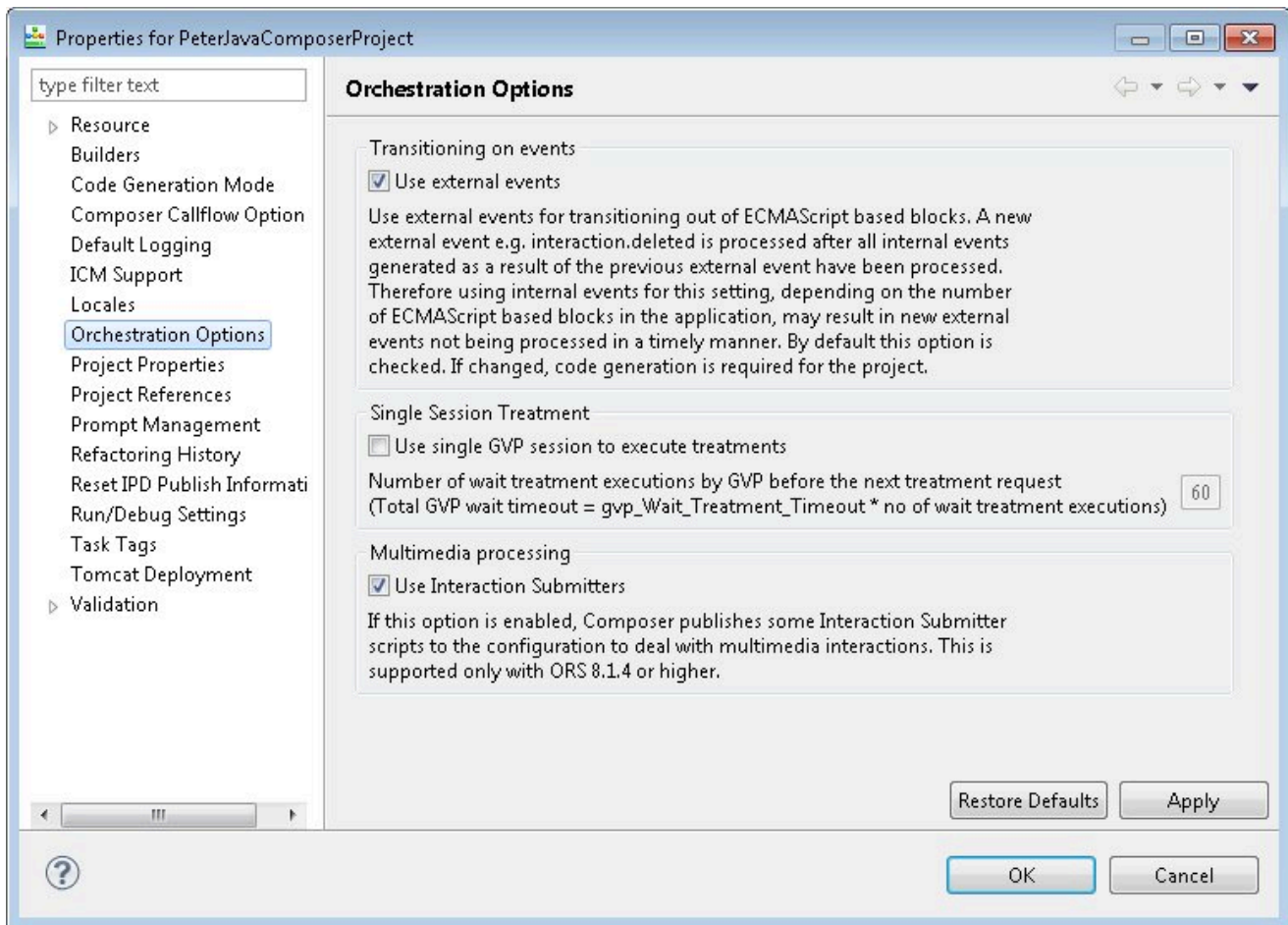

Workflow Block Changes

- Main workflow -> Exit /Disconnect Block: Generates code to end the GVP session if active based on KeepGVPSessionAlive and isGVPSessionActive flags.
- Play Application / Play Sound (music) -> Change in code to simulate treatments.

IPD Diagram Changes

- New event handlers have been added to handle communication between the GVP master page and the SCXML application.

1. `composer.dialog.play` - Play Application block request to IPD diagram for treatment request after the Master VXML page is in action.
2. `composer.dialog.start.done` - Master VXML page request to ORS session for treatment done.
3. `error.composer.dialog.start` - Master VXML page request to ORS session for treatment error.

4. `composer.dialog.exit` - Exit/Disconnect block request to IPD diagram for exiting GVP session.
5. `composer.workflow.proceed` - IPD diagram to Play Application block event to proceed further (compare to `dialog.start.done` or `dialog.start.requestid`).
6. `composer.workflow.exit` - IPD diagram response event to `composer.dialog.exit` request from Exit or Disconnect block event to proceed exit (After GVP session exists response "this event" is thrown).

Play Application Parameter Passing

In the traditional ORS treatments model, Play application treatment parameter passing happens via User Data, which has been sent along with the treatment request to GVP. In the Single GVP session model, User Data availability will be a limitation as the successive treatment requests happen via events. However, there are no changes to the input/output parameters defining mechanism in the Play Application block. That means the input/output parameters in Play Application blocks will be sent to the master VXML via events and then be propagated to each subdialog in `system_treatment_params` json object.

To receive Input parameters:

- In sub-callflows, instead of using `InteractionData` blocks to access User Data, use the `system_treatment_params` object's properties. First `<form>` in the Sub-callflow should have the following lines to receive the input parameters and the treatment language:

Note: Even if the Play Application block does not send or receive parameters, *the above `<var>` tags must be added to the Sub-Callflows since the Master VXML always sends these parameters.*

To return output parameters to Play Application blocks: No changes here; variables defined in the Exit block will return to the Play Application block (if `Wait for Treatment End` is set to true).

Master VXML Flow Page:

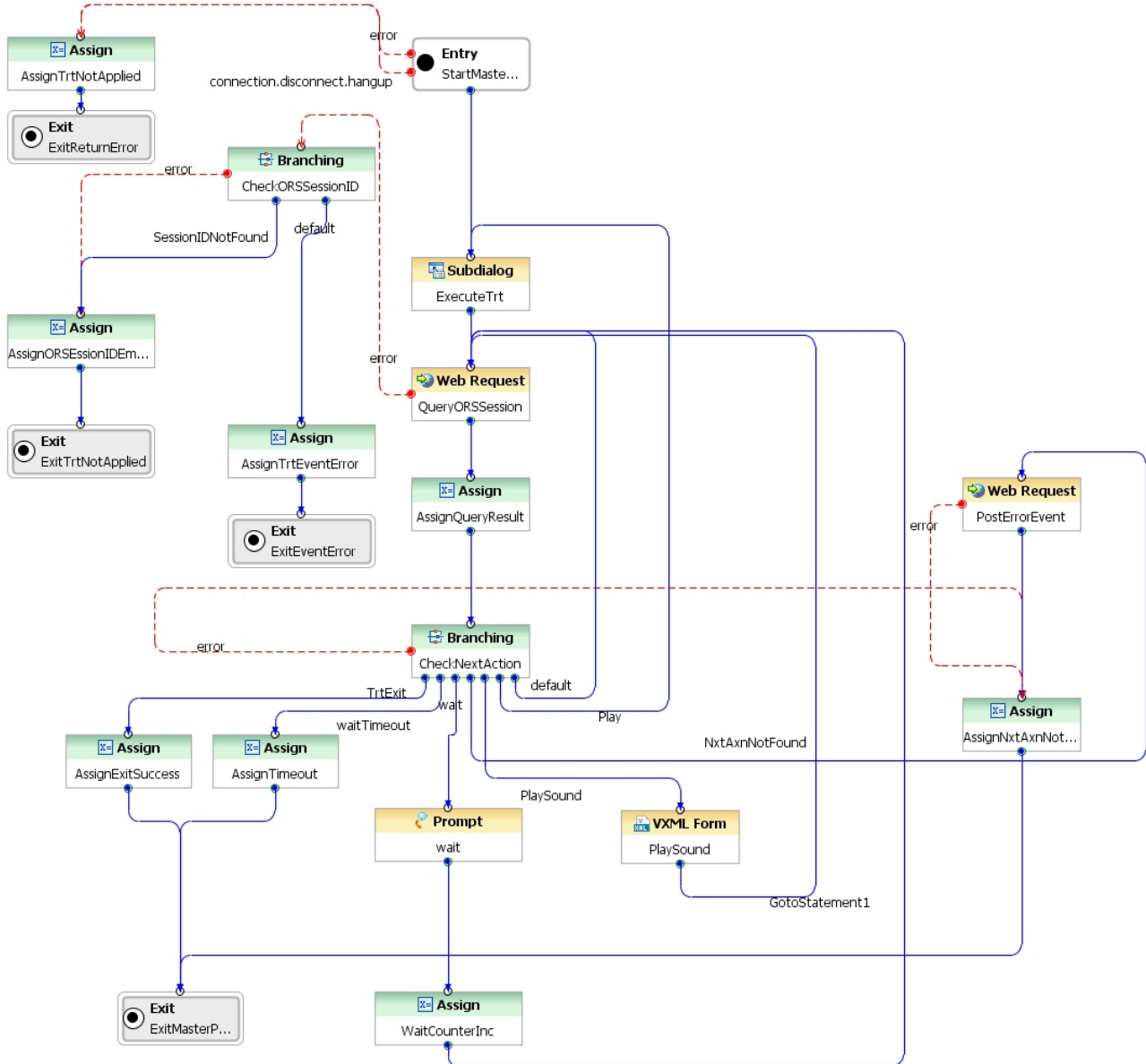

GVP Wait and Session Timeouts:

The GVP Master VXML application can wait to receive the next treatment request from the ORS session. The GVP wait timeout before requesting ORS is now controlled on the ORS side instead of GVP side due to Prompt queuing impacts. Following are the options available to control GVP wait timeout between treatments and GVP session timeout:

1. `gvp_wait_treatment_timeout` variable on the IPD diagram file is used to delay responses to GVP when no treatment is ready to be executed. The default value of this variable is 1s and this can be configured at the ERS object -> Application Params section in Configuration Manager. If configured, the new value will take effect.

-
2. Orchestration Option -> Property page -> Number of wait treatment requests should GVP wait to end the session. When there is no treatment to play for a while, this option is used to control the GVP session timeout.
 3. Total GVP session timeout = Number of wait requests * `gvp_Wait_Treatment_Timeout`. For example, 10 continuous wait requests with a delay of 3 seconds will provide 30-seconds of GVP Session timeout for a idle case -> $10 * 3s = 30 \text{ seconds}$.

Frequently Asked Questions

How can I run treatments in a separate GVP session while not disturbing the Master VXML session?
Using Assign blocks, set flag `_data.keepGVPSessionAlive` to false before your treatment block and reset to true after your treatment block.

What if ORS logic does not have any treatments after the first Play Application treatment?
The Master VXML session will poll ORS (IPD diagram SCXML) based on the `gvp_Wait_Treatment_Timeout` value until it reaches the maximum GVP Session Timeout (configurable via Composer Project properties) and ends the session as GVP Session timeout.

What if the workflow wants to end the Master VXML session in the middle of a call?
The workflow may have to send the "exit" treatment request to GVP to end the session.

How do I send and receive parameters in this GVP Single Session model?
Passing input parameters to the GVP session continue to work using the Udata methodology with no changes. Receiving output parameters happen via the `composer.dialog.start.done` event (`composer_treatment_result` option).

What if the "GVP Keepalive" option is unchecked in the Orchestration Options property page?
Code generation is required whenever there are changes in the Orchestration Options properties page. If the "GVP Keepalive" option is unchecked, code generation will generate code for normal ORS-MCP paradigm treatments.

How do I end the Master VXML treatment session in a workflow diagram?
Use SCXML state block to generate an "exit" request to the GVP Master Session.

What if the treatment URL is wrong or not available?
The Master VXML will try to execute the treatment URL as subdialog and return back the return results. If the URL cannot be executed, `error.composer.dialog.start` will be returned back as error result to IPD diagram.

How do I cancel the Master VXML treatment dialog using ORS Cancel Call?
The Master VXML session's dialog requestID will be available in the `_data.gvpMasterTreatmentRequestID` variable of the application. To manually end the GVP master VXML session use the following code snippet in a SCXML State block.

```
<state id="CancelMasterVXML">
  <onentry>
    <script>
```

```

                var composerRequestID = _sessionId+'_'+generateComposerTrtRequestID();
            </script>
<if cond="_data.keepGVPSessionAlive==true &&_data.isGVPSessionActive==true">
    <send event="'composer.dialog.exit'">
        <param name="treatment_id" expr="'exit'"/>
        <param name="treatment_url" expr="''"/>
        <param name="treatment_GVPRequestID"
expr="composerRequestID"/>
        <param name="treatment_waitForEnd" expr="'true'"/>
    </send>
    <else/>
        <raise event="proceedNext"/>
    </if>
</onentry>
<transition event="composer.workflow.exit" cond="_event.data.requestID ==
composerRequestID"
target="$NextBlock$">
<script>
        _data.isGVPSessionActive =false;
        _data.keepGVPSessionAlive = false;           // Optional - Set
keepGVPSessionActive to false
        to completely end the Single GVP session and run ordinary ORS treatments
onwards.
</script>
    </transition>
<transition event="proceedNext" target="$NextBlock$">
</transition>

```

What if the treatment URL VXML page is a Main type callflow (does not have the <return> tag, but instead the <exit> tag)?

If a Main type callflow diagram is used, a treatment VXML page would have an <exit> tag, which will end the GVP session and return back to ORS. As a result, successive treatment requests will start a new Master VXML page. For this reason, sub callflows are required to maintain a Master VXML page session.

When an ORS/workflow diagram does not have any treatment to execute, what will GVP do and how often will it poll an ORS session?

GVP will execute "wait" (silence) treatments while waiting for the next treatment request from ORS. GVP polls ORS based on the gvp_Wait_Treatment_Timeout value until the GVP session timeout is reached.

eServices Blocks

The eServices blocks are used to create a routing workflow for specialized processing of multimedia interactions. Also see the topic: [IRD Functionality Included in Composer](#).

Composer Route Block Name	Block Has Usable Output Data to be used in App?	Purpose
Analyze	Yes	Starting with release 8.1.410.14, Composer adds an Analyze block for enhanced content analysis.
Chat Transcript	Yes	Generates a reply e-mail to a chat interaction and attaches a chat transcript.
Classify Interaction	Yes	Classifies a text-based interaction based on content, and attach one or more Classification categories to the interaction.
Create E-mail	Yes	Creates an e-mail to be sent out
Email Forward	No Redirect E-mail Reply from External Resource	The Forward Type property specifies the type of functionality by allowing you to select Forward, Reply to Customer, or Redirect.
Email Response	Auto-acknowledgement Autoresponse Create Notification	Combines the functionality of IRD's Acknowledgement, Autoresponse, and Create Notification objects.
Create Interaction block	Yes	Creates an interaction record in the Universal Contact Server Database for a customer contact.
Create SMS	Yes	Creates a Short Message Service (SMS) message via an external SMS server
External Service(ESP)	Yes	Exchanges data with third party (non-Genesys) servers that use the Genesys Interaction SDK or any other server or application that complies with Genesys Interaction Server (GIS) communication protocol.
Find Interactions	Yes	Get the list of interactions matching some specific condition.
Identify Customer	Yes	Identifies a contact based on the interaction User Data . Returns a list of matching Contact IDs based on the User Data. Creates

		a contact record in the UCS Database or update the UCS Database record of the matching contact
Queue Interaction	No	Places a non-voice interaction in an existing queue
Route Interaction	No	Sends a non-voice interaction to one or more target objects: Agent, AgentGroup, PlaceGroup, Skill, or target contained in a variable.
Render Message	Yes	Requests Universal Contact Server to create message content.
Send E-mail	No	Sends an -email message created with Create E-mail block
Screen Interaction	Yes	Screens a text-based interaction for specific content (specific words or patterns)
Set Agent State	No	Dynamically manage agent resource states via ESP methods.
Send SMS	No	Send an SMS message created using the Create SMS block
Stop Interaction	No	Sends a request to Interaction Server to stop processing this interaction.
Update Contact	No	Updates customer profile information in the UCS Database, based on data attached to an interaction.
Update Interaction	No	Sends a request to Interaction Server to update or delete interaction attributes.
Update UCS Record	No	Updates the properties of an interaction in the Universal Contact Server database. Can be used for both interactions currently in process and interactions already processed.

Important

For the Create Email, Email Forward, Email Response, Send Email, Chat Transcript, and CreateSMS blocks, Orchestration Server does not copy User Data from any Interaction into an outgoing ESP request. Currently there is no attribute support to overwrite this behavior. If User Data must be included as part of the above blocks, use [External Service blocks](#) or [SCXML State blocks](#) to directly call the ESP methods (`\\CFGEmailServer\\Email\\Forward` and `\\CFGEmailServer\\Email\\Send`).

Special Note on Validation and Off-Line Mode

When using Composer in offline mode (not [connected to the Configuration Server](#)), you can edit block properties that depend on information from Configuration Server. Later, when you connect to Configuration Server and validate the Interaction Processing diagram, Composer will validate the values you entered in off-line mode.

eServices ECMAScript Functions

These functions are available for use in [Expression Builder](#).

- For classification segmentation, an [ECMAScript function](#) determines if a particular category name or ID exists in the array of category objects represented by an application variable. This variable can be the output of the Classify Interaction block, enabling the Branching block to be used for segmentation based on category.
- For manually attaching categories to an interaction, the [User Data block](#) can be used and then a branching block can be (optionally) used to segment interactions to different logical branches based on the different categories.

For a summary of the eServices blocks, see [Composer Equivalent to IRD Multimedia](#).

Composer Equivalent to IRD Multimedia

Composer includes multimedia functionality (processing non-voice interactions) that was previously provided through Genesys Interaction Routing Designer (IRD). The list below is not all-inclusive. Instead, it gives some examples for existing Genesys customers transitioning to Composer, who are familiar with using IRD's Multimedia objects.

Composer Route Block Name	Block Has Usable Output Data to be used in App?	Equivalent IRD Block/Object	Purpose
An ECMAScript function allows you to manually attach Classification categories to interactions	No	Attach Categories	Segment interactions to different logical branches based on the different categories.
Email Forward	No	Forward E-mail Redirect E-mail Reply from External Resource	The Forward Type property specifies the type of functionality by allowing you to select Forward, Reply to Customer, or Redirect.
Email Response	Yes	Autoknowledgement Autoresponse Create Notification	Combines the functionality of IRD's Acknowledgement, Autoresponse, and Create Notification objects.
Chat Transcript	Yes	Chat Transcript	Generates a reply e-mail to a chat interaction and attaches a chat transcript.
Classify Interaction	Yes	Classify	Classifies a text-based interaction based on content, and attach one or more Classification categories to the interaction.
Create E-mail	Yes	Create E-mail	Creates an e-mail to be sent out
Identify Customer	Yes	Identify Customer	Identifies a contact based on the interaction User Data . Returns a list of matching Contact IDs based on the User Data. Creates a contact record in the UCS Database or update the UCS Database record of the matching contact

Send E-mail	No	Send E-mail	Sends an -email message created with Create E-mail block
Screen Interaction	Yes		Screens a text-based interaction for specific content (specific words or patterns)
Create Interaction block	Yes	Create Interaction	Creates an interaction record in the Universal Contact Server Database for a customer contact.
Create SMS	Yes	Create SMS	Creates a Short Message Service (SMS) message via an external SMS server
Render Message	Yes	Render Message Content	Requests Universal Contact Server to create message content.
Send SMS	No	Send SMS	Send an SMS message created using the Create SMS block
Queue Interaction	No	Queue Interaction	Places a non-voice interaction in an existing queue
Route Interaction	No	Route Interaction	Sends a non-voice interaction to one or more target objects: Agent, AgentGroup, PlaceGroup, Skill, or target contained in a variable.
Stop Interaction	No	Stop Interaction	Sends a request to Interaction Server to stop processing this interaction.
Update Customer	No	Update Contact	Updates customer profile information in the UCS Database, based on data attached to an interaction.
External Service (ESP)	Yes	External Service	Exchanges data with third party (non-Genesys) servers that use the Genesys Interaction SDK or any other server or application that complies with Genesys Interaction Server (GIS) communication protocol.

<p>Special Note on Validation and Off-Line Mode: When using Composer in “offline” mode (not connected to the Configuration_Server), you can edit block properties that depend on information from Configuration Server. Later, when you connect to Configuration Server and validate the Interaction Processing diagram, Composer will validate the values you entered in off-line mode.</p>			
<p>Other Composer Blocks for Multimedia Processing</p>			
<p>Interaction Process Diagram (IPD)</p>	<p>NA</p>	<p>Business Process</p>	
<p>Interaction Queue Block</p>	<p>NA</p>	<p>Interaction Queue Block</p>	<p>Allows you to define an Interaction Queue used for multimedia interactions.</p>
<p>Media Server Block</p>	<p>NA</p>	<p>Media Server</p>	<p>Represents an existing Media Server, such as a chat or e-mail server. Allows you to get interactions into an IPD.</p>
<p>Workflow Block</p>	<p>NA</p>	<p>Strategy</p>	<p>Points to an existing Workflow resource (.workflow diagram) to which an interaction can be sent for processing.</p>

Also see [Context Services Blocks Overview](#).

Analyze Block

Starting with release 8.1.410.14, Composer adds an Analyze block for enhanced **content analysis**. The Analyze block, available on the eServices palette, combines the functionality of the existing Classify Interaction and Screen Interaction blocks and sorts **screening rules** into **categories**. The category name shows all roots so screening rules belonging to multiple categories can be selected in the same request.

An example is shown below.

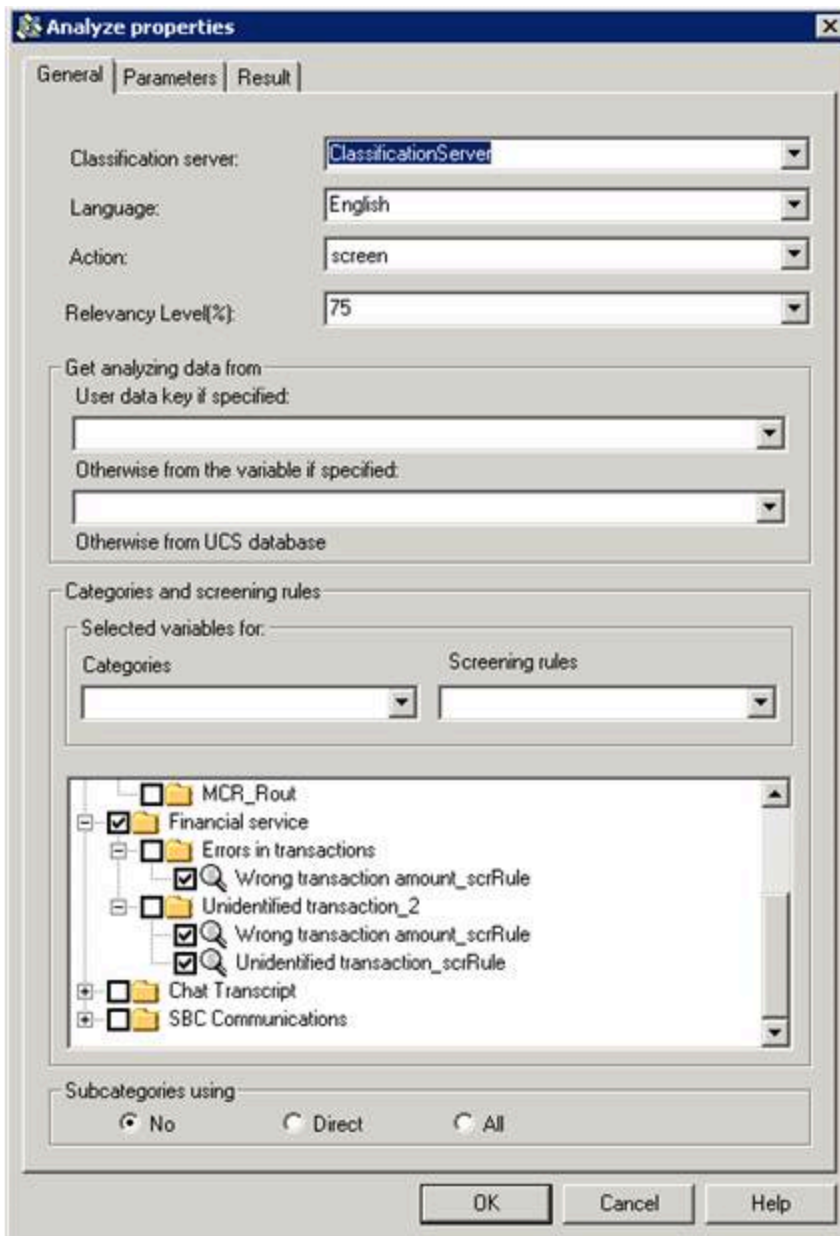

The Analyze Interaction block has the following properties:

Name Property

Find this property's details under [Common Properties](#).

Block Notes Property

Find this property's details under [Common Properties](#).

Exceptions Property

Find this property's details under [Common Properties](#). You can move `error.session.fetch` from **Not Supported** to **Supported**.

Condition Property

Find this property's details under [Common Properties](#).

Logging Details Property

Find this property's details under [Common Properties](#).

Log Level Property

Find this property's details under [Common Properties](#).

Enable Status Property

Find this property's details under [Common Properties](#).

Interaction ID Property

The current interaction ID. Defaults to the system variable `system.InteractionID`. Can be used for interaction-less processing for scenarios where the `InteractionId` variable is not automatically initialized, but instead must wait for an event. An example would be an SCXML application triggered by a Web Service that does not add an interaction.

Result Property



Select a variable for the raw result data (which arrives in json structure) returned by the Classification Server. The default is customerdata. The variable can be parsed and attached to the interaction for further use in the workflow, such as by attaching the results to an interaction's User Data. This enables you to analyze this User Data to make further routing decisions.

Action Property

Select screen, classify, or a variable. Only one Action can be selected.

Analyzing Data Property

This is where the data located for the **screening** or **classify** action. Enter a User Data key to search for data to be analyzed or enter a variable.



1. Click under **Value** to display the  button.
2. Click the  button to open the **Analyzing Data** dialog box.
 - If you select **Variable**, select a variable from the dropdown list.
 - If you select **User Data**, enter the User Data key to search.
 - If you select **UCS**, the Universal Contact Server database is used for analysis.

Important

UCS is selected by default and the data to be analyzed is taken from the Universal Contact Server database unless you select **Variable** or **User Data**.

Categories Property



Select the categories for classifying interactions.

1. Click under **Value** to display the  button.
2. Click the  button to open the **Categories** dialog box.
3. Click Add.
 - If you are connected to Configuration Server, you can select the categories for classification.
 - You can also select **Literal** and then enter the name of the category in the **Value** field.

- You can also select **Variable** and then select a variable containing the raw ID of the category from the **Value** field.

Classification Server Property

Select a Classification Server from those in the Configuration Server database. If you leave this field empty, **Interaction Server** uses the first available Classification Server named in its **Connections** list.

1. Click under **Value** to display the  button.
2. Click the  button to open the **Application Selection** dialog box.
3. The next step depends on whether you are connected to Configuration Server.
 - If you are connected, select **Configuration Server** from the **Type** dropdown menu. Select the name of the Classification Server from the **Value** field.
 - You can also select **Literal** and then enter the name of the server in the **Value** field.
 - You can also select **Variable** and then select a variable containing the server from the **Value** field.

Classify Subcategories Property



When the Action Property is **Classify**, this property determines whether Classification Server should consider parent and child categories (ParentMode in Requests. You can choose one of three options:

- To use all screening rules for a selected category, select **All Children**.
- To use only the direct children of a selected category (excluding parents), select **Direct Children**.
- To individually select categories and rules, use **Selected Categories**.

Continue to select categories/rules in this fashion until you have selected all the ones you want to use.

Language Property

Select the language of the incoming interaction. The categories and screening rules shown are changed according to selected language. Only those roots associated (through their **Annex** General/ Language property) with the selected language are shown.

1. Click under **Value** to display the  button.
2. Click the  button to open the **Language** dialog box.
3. The next step depends on whether you are connected to Configuration Server.
 - If you are connected, select **Configuration Server** from the **Type** dropdown menu. Select the Language from the **Value** field.



-
- You can also select **Literal** and then enter the name of the language in the **Value** field.
 - You can also select **Variable** and then select a variable containing the language from the **Value** field.

Relevancy Level Property

If the Classify **Action** is selected, select a variable or type a percentage indicating that the minimum relevancy (confidence) to which each category must be greater than or equal to in order for Classification Server to consider an interaction as belonging to that category (that is, you are setting the threshold for relevance). You can change the default, but you cannot enter zero.

Screening Rules Property

Select the screening rules to be used when screening interactions.

1. Click under **Value** to display the  button.
2. Click the  button to open the **Screening Rules** dialog box.
3. Click **Add**.
4. Perform one of the following actions:
 - If you are connected to Configuration Server, you can select screening rules.
 - You can also select **Literal** and then enter the name of the screening rule in the **Value** field.
 - You can also select **Variable** and then select a variable containing the screening rule name from the **Value** field. If you use variables, you cannot select from folders. You can either select from folders or specify variables, but you cannot do both.

If the category and screening rule identifiers do not sufficiently describe them, you can look up them up in Configuration Manager (Business Attributes), or in Genesys Administrator, or in **eServices Knowledge Manager**, where they were originally defined.

Tenant Property

If your environment has more than one **Tenant**, select a variable identifying the tenant in the Configuration Database. The default is `system.TenantID`.

Enable Status Property

Find this property's details under **Common Properties**.

ORS Extensions Property

Starting with release 8.1.4, Composer blocks used to build routing applications (with the exception of the Disconnect and EndParallel blocks) include the **ORS Extensions** property.

Samples

[+] Analyze Action Classify

REQUEST

```
'Version' [str] = "1.0"
'AppType' [str] = "90"
'AppName' [str] = "ClassificationServer2_sbbelovdt"
'Service' [str] = "Analyze"
'Method' [str] = "ClassifyScreenUniversal"
'Parameters' [lst] = KVList:
  'Action' [str] = "Classify"
  'Language' [str] = "English"
  'Categories' [str] = "00016a6W8MUA002Q | 00057a9K3JNC02V7 | 0005Ba9QMHV30KCY"
  'ParentMode' [str] = "3"
  'RelevancyLevel' [str] = "10"
  'IxnText' [str] = "You should transplant these irises into an area providing at least
6 hrs of direct sunlight a day."
```

```
bstr [bstr] = KVList:
'TenantId' [int] = 101
```

RESPONSE

```
'Version' [str] = "1.0"
'Service' [str] = "Analyze"
'Method' [str] = "ClassifyScreenUniversal"
'Parameters' [lst] = KVList:
  'Categories' [lst] = KVList:
    'How do I dig irises' [lst] = KVList:
      'CtgId' [str] = "00057a9K3JNC038G"
      'CtgName' [str] = "How do I dig irises"
      'CtgRootName' [str] = "plants"
      'CtgPath' [str] = "plants/iris/How do I dig irises"
      'CtgRelevancy' [str] = "32"
    'Why are they not blooming' [lst] = KVList:
      'CtgId' [str] = "00057a9K3JNC038N"
      'CtgName' [str] = "Why are they not blooming"
      'CtgRootName' [str] = "plants"
      'CtgPath' [str] = "plants/iris/Why are they not blooming"
      'CtgRelevancy' [str] = "26"
    'J2EBJ183K80HB6G2' [lst] = KVList:
      'CtgId' [str] = "00016a6W8MUA005Y"
      'CtgName' [str] = "J2EBJ183K80HB6G2"
      'CtgRootName' [str] = "SBC_1_Root"
      'CtgPath' [str] = "SBC_1_Root/J2EBJ183K80HB6G2"
      'CtgRelevancy' [str] = "12"
    'Sub_A' [lst] = KVList:
      'CtgId' [str] = "0005Ba9QMHV30KDE"
      'CtgName' [str] = "Sub_A"
      'CtgRootName' [str] = "MySimpleTest"
      'CtgPath' [str] = "MySimpleTest/Sub_A"
      'CtgRelevancy' [str] = "100"
```

```

'19CSBDR3K82AXEGS' [lst] = KVList:
  'CtgId' [str] = "00016a6w8MUA004K"
  'CtgName' [str] = "19CSBDR3K82AXEGS"
  'CtgRootName' [str] = "SBC_1_Root"
  'CtgPath' [str] = "SBC_1_Root/19CSBDR3K82AXEGS"
  'CtgRelevancy' [str] = "36"
'How should I prepare iris for shipping' [lst] = KVList:
  'CtgId' [str] = "00057a9K3JNC038Y"
  'CtgName' [str] = "How should I prepare iris for shipping"
  'CtgRootName' [str] = "plants"
  'CtgPath' [str] = "plants/iris/How should I prepare iris for shipping"
  'CtgRelevancy' [str] = "19"
'Why did my irises change color' [lst] = KVList:
  'CtgId' [str] = "00057a9K3JNC038T"
  'CtgName' [str] = "Why did my irises change color"
  'CtgRootName' [str] = "plants"
  'CtgPath' [str] = "plants/iris/Why did my irises change color"
  'CtgRelevancy' [str] = "25"
'CtgId' [str] = "0005Ba9QMHV30KDE"
'CtgName' [str] = "Sub_A"
'CtgRootName' [str] = "MySimpleTest"
'CtgPath' [str] = "MySimpleTest/Sub_A"
'CtgRelevancy' [str] = "100"

```

[+] Analyze Action Screen

REQUEST

```

'Version' [str] = "1.0"
'AppType' [str] = "90"
'AppName' [str] = "ClassificationServer2_sbbelovdt"
'Service' [str] = "Analyze"
'Method' [str] = "ClassifyScreenUniversal"
'Parameters' [lst] = KVList:
  'Action' [str] = "Screen"
  'Language' [str] = "English"
  'Categories' [str] = ""
  'Rules' [str] = ""
  'RelevancyLevel' [str] = "15"
  'ParentMode' [str] = "3"
  'IxnText' [str] = "problem, accounts 1111-1111-1111-1111 and 2222-2222-2222-2222"

```

```

bstr [bstr] = KVList:
'TenantId' [int] = 101

```

RESPONSE

```

'Version' [str] = "1.0"
'Service' [str] = "Analyze"
'Method' [str] = "ClassifyScreenUniversal"
'Parameters' [lst] = KVList:
  'ScreenRuleMatch' [str] = "true"
  'Categories' [lst] = KVList:
    'Neutral' [lst] = KVList:
      'CtgId' [str] = "00006a69F6861XCW"
      'CtgName' [str] = "Neutral"

```

```

'CntgRootName' [str] = "Sentiment"
'CntgPath' [str] = "Sentiment/Neutral"
'CntgRelevancy' [str] = "75"
'Screen' [lst] = KVList:
  'ScreenForNeutralSentiment' [lst] = KVList:
    'RuleId' [str] = "00006a69F6861XED"
    'RuleName' [str] = "ScreenForNeutralSentiment"
    'RuleOrder' [str] = "12"
    'RuleRelevancy' [str] = "75"
'Positive' [lst] = KVList:
  'CntgId' [str] = "00006a69F6861XCP"
  'CntgName' [str] = "Positive"
  'CntgRootName' [str] = "Sentiment"
  'CntgPath' [str] = "Sentiment/Positive"
  'CntgRelevancy' [str] = "85"
  'Screen' [lst] = KVList:
    'Tech support' [lst] = KVList:
      'RuleId' [str] = "00003a01DST4006D"
      'RuleName' [str] = "Tech support"
      'RuleOrder' [str] = "400"
      'FoundValues' [lst] = KVList:
        'CardNo(1)' [str] = "1111-1111-1111-1111"
        'CardNo(2)' [str] = "2222-2222-2222-2222"
      'RuleRelevancy' [str] = "85"
    'SB_MultiScanTest' [lst] = KVList:
      'RuleId' [str] = "0003Fa8RRCHA0030"
      'RuleName' [str] = "SB_MultiScanTest"
      'RuleOrder' [str] = "10"
      'FoundValues' [lst] = KVList:
        'CardNo(1)' [str] = "1111-1111-1111-1111"
        'CardNo(2)' [str] = "2222-2222-2222-2222"
      'RuleRelevancy' [str] = "75"
'Actionable' [lst] = KVList:
  'CntgId' [str] = "00006a69F6861XHN"
  'CntgName' [str] = "Actionable"
  'CntgRootName' [str] = "Action"
  'CntgPath' [str] = "Action/Actionable"
  'CntgRelevancy' [str] = "75"
  'Screen' [lst] = KVList:
    'Tech support' [lst] = KVList:
      'RuleId' [str] = "00003a01DST4006D"
      'RuleName' [str] = "Tech support"
      'RuleOrder' [str] = "400"
      'FoundValues' [lst] = KVList:
        'CardNo(1)' [str] = "1111-1111-1111-1111"
        'CardNo(2)' [str] = "2222-2222-2222-2222"
      'RuleRelevancy' [str] = "75"
    'SB_MultiScanTest' [lst] = KVList:
      'RuleId' [str] = "0003Fa8RRCHA0030"
      'RuleName' [str] = "SB_MultiScanTest"
      'RuleOrder' [str] = "10"
      'FoundValues' [lst] = KVList:
        'CardNo(1)' [str] = "1111-1111-1111-1111"
        'CardNo(2)' [str] = "2222-2222-2222-2222"
      'RuleRelevancy' [str] = "45"
'UnclearIfActionRequired' [lst] = KVList:
  'CntgId' [str] = "00006a69F6861XJ3"
  'CntgName' [str] = "UnclearIfActionRequired"
  'CntgRootName' [str] = "Action"
  'CntgPath' [str] = "Action/UnclearIfActionRequired"
  'CntgRelevancy' [str] = "75"
  'Screen' [lst] = KVList:
    'UnclearIfActionRequired' [lst] = KVList:

```

```
'RuleId' [str] = "00006a69F6861XN2"  
'RuleName' [str] = "UnclearIfActionRequired"  
'RuleOrder' [str] = "10"  
'RuleRelevancy' [str] = "75"  
'CtgId' [str] = "00006a69F6861XCP"  
'CtgRelevancy' [str] = "85"  
'CtgName' [str] = "Positive"  
'CtgRootName' [str] = "Sentiment"  
'CtgPath' [str] = "Sentiment/Positive"
```

Chat Transcript Block

Use to create (but not send) an e-mail message that is generated from your site's [Standard Response Library](#) and which has the customer's chat transcript attached. Use the [Send Email block](#) to send the message out.

Tip

This block is only used for creating a chat transcript. For an example interaction process diagram and workflow strategy that routes interactions to agent targets skilled in handling chats, see [Customizing the Chat Routing Strategy](#).

Use Case

1. A routing workflow is configured in Composer and deployed to route interactions to agents with a chat [Skill](#) or an Agent Group specifically created to handle chat interactions.
2. The customer requests a chat, and the agent presses a button on his desktop to initiate a chat interaction into the Genesys system. The context of the interaction includes information provided by the agent desktop, including a customer ID and the subject of the chat.
3. The routing workflow uses information, such as the customer ID and the subject of the chat, to identify additional customer details, such as customer name, from the Universal Contact Server database.
4. A customer engages in a chat interaction with the agent.
5. At the end of the chat conversation, the agent asks the customer if he wants to receive a chat transcript.
6. If yes, the routing workflow creates (Chat Transcript block) and sends an e-mail message that includes the chat transcript. The e-mail message uses text from the eServices Standard Response library, which was retrieved based on the subject of the chat, and personalized to include the customer's first and last name.

Special Note on Cc, From, and Exclude Addresses Properties

The Literal and Variable types can have a value set to an actual e-mail address, e.g., joe@test.com, or refer to the name of a previously configured e-mail address from Configuration Server (e.g., if "Tech Support" is configured as a Configuration Server E-mail Accounts [Business Attribute](#), then "Tech Support" can be the value for the Literal type and the platform will use that e-mail address).

Important

For the Create Email, Email Forward, Email Response, Send Email, Chat Transcript, and CreateSMS blocks, Orchestration Server does not copy User Data from any Interaction into an outgoing ESP request. Currently there is no attribute support to overwrite this behavior. If User Data must be included as part of the above blocks, use [External Service blocks](#) or [SCXML State blocks](#) to directly call the ESP methods (\\CFGEmailServer\\Email\\Forward and \\CFGEmailServer\\Email\\Send).

The Chat Transcript block has the following properties:

Name Property

Find this property's details under [Common Properties](#).

Block Notes Property

Find this property's details under [Common Properties](#).

Email Server Property

Find this property's details under [Common Properties](#).

Exceptions Property

Find this property's details under [Common Properties](#).

Associate New Interaction Property

This property, introduced in Composer 8.1.420.xx for the Chat Transcript, Create Email, Create SMS, Email Forward, and Email Response blocks, supports the Orchestration Server `<ixn:createmessage>` tag `associate` attribute. See [Using eServices Blocks](#), section Associate New Interaction. This property requires Orchestration Server version 8.1.400.45+.

Do Not Thread Property

Find this property's details under [Common Properties](#).

Output Queue Property

Find this property's details under [Common Properties](#).

Starting with Release 8.1.410.14, you can use a queue defined in referenced Projects. For more information, see [Adding an Interaction Queue](#).

CC Property

Find this property's details under [Common Properties](#).

Exclude Email Addresses Property

Find this property's details under [Common Properties](#).

Field Codes Property

Find this property's details under [Common Properties](#).

From Property

Find this property's details under [Common Properties](#).

Standard Response Property

Find this property's details under [Common Properties](#).

Subject Property

Find this property's details under [Common Properties](#).

To Property

Find this property's details under [Common Properties](#).

Use Subject From SRL Property

Find this property's details under [Common Properties](#).

Interaction ID Property

Find this property's details under [Common Properties](#).

Output Result Property

Find this property's details under [Common Properties](#).

Detach Property

Find this property's details under [Common Properties](#).

Detach Timeout Property

Find this property's details under [Common Properties](#).

Condition Property

Find this property's details under [Common Properties](#).

Logging Details Property

Find this property's details under [Common Properties](#).

Log Level Property

Find this property's details under [Common Properties](#).

Enable Status Property

Find this property's details under [Common Properties](#).

ORS Extensions Property

Starting with 8.1.4, Composer blocks used to build routing applications (with the exception of the Disconnect and EndParallel blocks) add a new [ORS Extensions](#) property.

Classify Interaction Block

Use to have Universal Routing Server instruct Classification Server to assign one or more category codes (configured in Knowledge Manager as described in the [eServices 8.1 User Guide](#)) to a text-based interaction. Once a category code is assigned, other types of processing can occur based on the category code.

ECMAScript Functions

- For classification segmentation, a `ClassifyInteraction` ECMAScript function (`containsCategoryName`) determines if a particular category name exists in the array of category objects represented by an application variable. This variable can be the output of the “Classify Interaction” block, enabling the Branching block to be used for segmentation based on category.
- Another ECMAScript function (`attachCategory`) allows you to manually attach Classification categories to interactions, and then (optionally) segment interactions to different logical branches based on the different categories. The category or categories to be attached to an interaction can be based on classification applied to the interaction at a prior point in the routing workflow.

Both of the above functions are available in [Expression Builder](#) > Workflow Functions > Misc.

Classification Versus Screening

The primary difference between classification and screening ([Screen Interaction block](#)) is as follows:

- The result of screening for certain words or patterns is a Screening Rule name and the value of true or false.
- The result of classification based on content analysis (you must have the Content Analyzer option installed as described in the [eServices 8.1 User Guide](#)) is a category code, which can be associated with a Standard Response or used for other purposes, such as segmentation.

For more information on screening and classification, see the chapter on IRD objects in the [Universal Routing 8.1 Reference Manual](#). Also see the [Universal Routing 8.1 Business Process User's Guide](#).

Note: If your site's categories are not yet defined in Knowledge Manager, you may wish to use the Screen Interaction block, which performs word matching instead of using category codes.

Use Case

1. An e-mail arrives on a route point, initiating a routing workflow.
2. The routing workflow examines the content of the e-mail and attempts to classify the text based on

classification categories set up in Knowledge Manager.

3. An auto-response e-mail is created, using a standard response from the standard response library. The response selected is based on the categorization of the email performed in step 2.
4. The auto-response email is sent to the customer.

The Classify Interaction block has the following properties:

Name Property

Find this property's details under [Common Properties](#).

Block Notes Property



Find this property's details under [Common Properties](#).

Exceptions Property

Find this property's details under [Common Properties](#).



Classification Categories Property

Use to select the location to store resulting classification categories after classification.

1. Click under Value to display the  button.
2. Click the  button to open the Classification Categories dialog box. For **Type**, select **User Data** or **Variable**. If you select **User Data**, specify the User Data key for the classification results. If you select **Variable**, select the variable that contains the User Data key for the classification results.

Categories Property



Use this property to select individual categories and sub-categories of the Root Category to be used in the classification process.

1. Click under Value to display the  button.
2. Click the  button to open the Categories dialog box.

3. Click Add to open the Select Items dialog box.
4. From the Type dropdown menu, do one of the following:
 - If you are **connected to Configuration_Server**, select **Configuration Server**. Select one or more categories for the **Value**.
 - Select **Literal** and enter the categories in the **Value** field. Use commas to separate the categories.
 - Select **Variable** and select the variable that contains the categories from the **Value** field.



Classification Data Property

Use this property to select whether to search for classification data in the interaction's User Data, from a variable, or from the UCS database.

1. Click under **Value** to display the  button.
2. Click the  button to open the Classification Data dialog box.
3. For **Type**, select **UCS**, **User Data** or **Variable**. If you select **UCS**, don't specify fields. Data available as part of the interaction is automatically picked up for classification by ORS. If you select **User Data**, specify the key-value pairs. If you select **Variable**, select the variable that contains the key-value pairs.

Classification Server Property

Select the Application name for the Classification Server from those in the Configuration Database. If a Classification Server is not selected, the platform will internally select one.



1. Click under Value to display the  button.
2. Click the  button to open the Application Selection dialog box.
3. The next step depends on whether you are connected to Configuration Server.
 - You can also select **Literal** or **Variable** from the **Type** dropdown menu. If you select **Literal**, enter the name of the classification server in the **Value** field. If you select **Variable**, select the variable from the **Value** field.
 - If you are connected, select **Configuration Server** from the **Type** dropdown menu. Select the name of the Classification Server from the **Value** field.

Confidence Level Property

Select a variable that contains a number from 1 to 100 that reflects the minimum relevance percentage that each classification category must have in order for Classification Server to consider an interaction as belonging to that category.

Root Category Property

Select the name of the top-level category to be used for the classification.

1. Click under Value to display the  button.
2. Click the  button to open the Root Category dialog box.
3. The next step depends on whether you are connected to Configuration Server.
 - If you are connected, select **Configuration Server** from the **Type** dropdown menu. A tree of classification categories appears in the **Value** field. Next, select the name of the top-level (root) classification category. This is a directory that appears in Configuration Manager in the Business Attributes > Category Structure folder. For more information on Root folders, see the *Universal Routing 8.1 Reference Manual*.
 - You can also select **Literal** or **Variable** from the **Type** dropdown menu. If you select **Literal**, enter the name of the root category in the **Value** field. If you select **Variable**, select the variable that contains the root category from the **Value** field.

Subcategories Property

Click the down arrow and select one of the following:

- **Do not include children of selected categories.**
- **Include immediate children of selected categories.**
- **Include all children (recursively) of selected categories.**

Condition Property

Find this property's details under [Common Properties](#).

Logging Details Property

Find this property's details under [Common Properties](#).

Log Level Property

Find this property's details under [Common Properties](#).

Enable Status Property

Find this property's details under [Common Properties](#).

ORS Extensions Property

Starting with 8.1.4, Composer blocks used to build routing applications (with the exception of the Disconnect and EndParallel blocks) add a new [ORS Extensions](#) property.

Create E-mail Block

Use this block to create an e-mail message to be sent out to a customer or another agent and to specify the **interaction queue** where the outbound e-mail should be placed. The selected interaction queue appears as a workflow-generated block in the **interaction process diagram**.

To create the e-mail text, you have the following options:

- Use text from your Standard Response Library (SRL). In this case, you must specify the SRL identifier defined in eServices/Multimedia Knowledge Manager.
- Use text associated with the default/active Standard Response for a specified Knowledge Manager Category code. In this case, you must specify the Category code defined in Knowledge Manager.

Category trees are a means of organizing and gaining access to the library of Standard Responses. In the Universal Contact Server Database, each Standard Response must be associated with at least one Category code. Content Analyzer can classify an incoming e-mail in terms of the Category tree.

See the **eServices** documentation, *Knowledge Manager 8.1 Help* for more information on Standard Responses and Category codes.

Use Case

1. An inbound interaction initiates a routing workflow.
2. Based on the interaction the customer is identified and the User Data of the interaction is updated.
3. The User Data is then assigned to variables and is used to create an e-mail response with the First Name, Last Name and the contact address of the customer.
4. The e-mail created for this customer uses the User Data to find an appropriate response from the Standard Response Library as well. The Standard Response selected is based on some purpose inferred from the customer's original e-mail.

Important

For the Create Email, Email Forward, Email Response, Send Email, Chat Transcript, and CreateSMS blocks, Orchestration Server does not copy User Data from any Interaction into an outgoing ESP request. Currently there is no attribute support to overwrite this behavior. If User Data must be included as part of the above blocks, use **External Service blocks** or **SCXML State blocks** to directly call the ESP methods (`\\CFGEmailServer\\Email\\Forward` and `\\CFGEmailServer\\Email\\Send`).

Special Note on From and To Properties

The Literal and Variable types can have a value set to an actual e-mail address, e.g., joe@test.com, or refer to the name of a previously configured e-mail address from Configuration Server (e.g., if “Tech Support” is configured as a Configuration Server E-mail Accounts Business Attribute, then “Tech Support” can be the value for the Literal type and the platform will use that e-mail address).

The Create E-mail block has the following properties:

Name Property

Find this property's details under [Common Properties](#).

Block Notes Property

Find this property's details under [Common Properties](#).

Email Server Property

Find this property's details under [Common Properties](#).

Exceptions Property

Find this property's details under [Common Properties](#).

Associate New Interaction Property

This property, introduced in Composer 8.1.420.xx for the Chat Transcript, Create Email, Create SMS, Email Forward, and Email Response blocks, supports the Orchestration Server `<ixn:createmessage>` tag associate attribute. See [Using eServices Blocks](#), section Associate New Interaction. This property requires Orchestration Server version 8.1.400.45+.

Create New Interaction Property

Select true or false to indicate whether a new interaction record should be created in the Universal Contact Server Database for this outbound e-mail. The default is false.

Do Not Thread Property

Find this property's details under [Common Properties](#).

Output Queue Property

Find this property's details under [Common Properties](#).

Starting with Release 8.1.410.14, you can use a queue defined in referenced Projects. For more information, see [Adding an Interaction Queue](#).

Field Codes Property

Find this property's details under [Common Properties](#)

From Property

Find this property's details under [Common Properties](#).

Include Original Message Into Reply Property

Find this property's details under [Common Properties](#).

Standard Response Property

Find this property's details under [Common Properties](#).

Subject Property

Find this property's details under [Common Properties](#).

To Property

Find this property's details under [Common Properties](#).

Use Subject From SRL Property

Find this property's details under [Common Properties](#).

Interaction ID Property

Find this property's details under [Common Properties](#).

Related Interaction ID Property

Select a variable for the current interaction ID or keep the default, which is system.InteractionID. For information on the value, see the Entry block, Variables property, System Variables.

Output Result Property

Find this property's details under [Common Properties](#).

Detach Property

Find this property's details under [Common Properties](#).

Detach Timeout Property

Find this property's details under [Common Properties](#).

Condition Property

Find this property's details under [Common Properties](#).

Logging Details Property

Find this property's details under [Common Properties](#).

Log Level Property

Find this property's details under [Common Properties](#).

Enable Status Property

Find this property's details under [Common Properties](#).

ORS Extensions Property

Starting with 8.1.4, Composer blocks used to build routing applications (with the exception of the Disconnect and EndParallel blocks) add a new [ORS Extensions](#) property.

Create Interaction Block

Use this block to create an interaction record in the Universal Contact Server Database, for a customer contact. This saves the current interaction being processed in the database.

Tip

For "native" Genesys interaction types such as e-mail and chat, interactions are automatically created in the Universal Contact Server (UCS) database. The Create Interaction block would be used primarily for creating interactions in UCS when there are new interactions coming into the Genesys system through the Open Media interface. This is the primary mechanism for making interaction data available to an agent desktop application.

Use Case

1. An incoming fax initiates a routing strategy (routing workflow).
2. The fax server has OCR (character recognition) to extract the customer details from the fax. These are identified and attached to the interaction.
3. The routing strategy creates an interaction in the UCS database, associated with this customer.

The Create Interaction block has the following properties:

Name Property

Find this property's details under [Common Properties](#).

Block Notes Property

Find this property's details under [Common Properties](#).

Data MIME Type Property

Use this property for an interaction with binary content to specify the [MIME Type](#) for the binary content. Click the down arrow and select one of the following MIME types or a variable that contains the MIME type. This information helps Agent Desktop Application to choose the proper application to

process or display the binary part of the interaction. This field cannot be empty if the **Data User Data Key Property** contains a value.

application/msword	audio/mpeg	message/sipfrag
application/octet-stream	audio-mpeg4-generic	message/tracking-status
application/postscript	image/g3fax	multipart/alternative
application/rtf	image/gif	multipart/form-data
application/vnd.ms-powerpoint	image/jpeg	multipart/mixed
application/vnd.ms-project	image/tiff	multipart/parallel
application/vnd.visio	message/delivery-status	multipart/voice-message
application/voicexml+xml	message/http	text/html
application/xml	message/news	text/plain
application/xml-dtd	message/partial	text/richtext
application/zip	message/rfc822	text/xml
audio/basic	message/sip	

Data User Data Key Property

If the interaction contains binary data, select the variable that contains the **UserData** key whose value is the interaction binary content.

Structured Text MIME Type Property

If the interaction contains structured text, use this property to specify the MIME type. Select the variable that contains the MIME type for the interaction's structured text or select one of the following:

- **text/html**
- **text/plain**
- **text/rich text**
- **text/html**

What you select here assists the Agent Desktop Application in choosing the proper application to process or display this part of interaction. This field is mandatory if the **Structured Text User Data Key** property contains a value.

Structured Text User Data Key Property

If the interaction contains structured text, select the variable that contains the User Data whose value is the interaction structured text. The value will be stored in the Universal Contact Server Database as interaction's structured text.

Text User Data Key Property

If the interaction contains plain text, select the variable that contains the User Data key whose value is the interaction plain text. The value will be stored in the UCS Database as the interaction's plain text.

Exceptions Property

Find this property's details under [Common Properties](#).

Also see [ExceptionEvents for eServices/UCS Blocks](#). Exceptions supported: 201, 202, 203, 204, 502, 512, 701, 710, 716, 732.

Condition Property

Find this property's details under [Common Properties](#).

Logging Details Property

Find this property's details under [Common Properties](#).

Log Level Property

Find this property's details under [Common Properties](#).

Enable Status Property

Find this property's details under [Common Properties](#).

Orchestration Interaction ID Property

Select the variable that contains the interaction identifier for Orchestration Server.

Output Interaction ID Property

Select the variable that contains the identifier for the created interaction.

Bind With Contact Property

Select true to have Universal Contact Server look for a customer contact record and associate it with the interaction. If a contact record is not found, it will be created.

Can Be Parent Property

Select true if this interaction can have child interactions.

Do Not Thread Property

Find this property's details under [Common Properties](#).

Tenant Property

Find this property's details under [Common Properties](#).

Universal Contact Server Property

Find this property's details under [Common Properties](#).

Update Interaction User Data Property

Find this property's details under [Common Properties](#).

ORS Extensions Property

Starting with 8.1.4, Composer blocks used to build routing applications (with the exception of the Disconnect and EndParallel blocks) add a new **ORS Extensions** property.

Create SMS Block

Use this block to create an outbound message, which can be sent out as a Short Message Service (SMS) message to an external SMS Server. SMS refers to the common text messaging service available on cellphones and other handheld devices. You can also specify the **interaction queue** where the SMS message should be placed. This version of Composer supports native SMS, which means that the SMS message is sent via SMS Server and not via an e-mail to SMS gateway.

Also see the [Render Message block](#).

Important

For the Create Email, Email Forward, Email Response, Send Email, Chat Transcript, and CreateSMS blocks, Orchestration Server does not copy User Data from any Interaction into an outgoing ESP request. Currently there is no attribute support to overwrite this behavior. If User Data must be included as part of the above blocks, use [External Service blocks](#) or [SCXML State blocks](#) to directly call the ESP methods (`\\CFGEmailServer\\Email\\Forward` and `\\CFGEmailServer\\Email\\Send`).

The Create SMS block has the following properties:

Name Property

Find this property's details under [Common Properties](#).

Block Notes Property

Find this property's details under [Common Properties](#).

SMS Server Property

To select an SMS Server for sending the message:

1. Select the SMS Server row in the block's property table.
2. Click under Value to display a down arrow.
3. Select an SMS Server from those in the Configuration Database.

Exceptions Property

Find this property's details under [Common Properties](#).



Associate New Interaction Property

This property, introduced in Composer 8.1.420.xx for the Chat Transcript, Create Email, Create SMS, Email Forward, and Email Response blocks, supports the Orchestration Server `<ixn:createmessage>` tag associate attribute. See [Using eServices Blocks](#), section Associate New Interaction. This property requires Orchestration Server version 8.1.400.45+.

Interaction Queue Property

Select the interaction queue where the SMS Server should place the outbound SMS. Only the interaction queues that have been created using Composer in the current Composer Project are shown for the Configuration Server values. The interaction queues are sorted per parent Interaction Process Diagram.

To define the output queue:

1. Click under Value to display the  button.
2. Click the  button to open the Select an Output Queue dialog box.
3. Click the Type down arrow and do one of the following
 - If you are connected to Configuration Server, select **Configuration Server** and then select an output queue as the Value. The **Independent Objects > Same queue** choice allows you to put the outbound e-mail in the same interaction queue that initiated the current interaction.
 - Select **Literal** and then enter the name of the output queue as the **Value**.
4. Click OK.

Starting with Release 8.1.410.14, you can use a queue defined in referenced Projects. For more information, see [Adding an Interaction Queue](#).

Interaction Subtype Property

Select an Interaction Subtype code (defined in the Configuration Database Business Attributes folder), which can represent an Acknowledgement, Autoresponse, or Outbound New Standard Response subtype. The default is OutboundNew.

Message Destination Number Property

Enter the mobile telephone number of the person to whom the message is to be sent.



See the [Getting and Using E-mail Address](#) topic for more information. While the topic focuses on the supplying a To e-mail address, the same ideas apply to getting a customer's mobile telephone number with Context Services blocks and using it for this property.

Message Source Number Property

Enter the mobile telephone number from which the SMS message should appear to come.

Message Text Property

Use this property to specify the Short Message Server text.

1. Click under Value to display the  button.
2. Click the  button to open the Select SMS Text Message dialog box.
3. Select **User Data**, **Literal** or **Variable** from the Type dropdown menu.

If you select **Literal**, enter the text in the **Value** field.

- If you select **User Data**, enter the User Data keys in the **Value** field.
- If you select **Variable**, select the variable from the **Value** field that contains the text.

4. Click **OK** to close the dialog box.

Interaction ID Property

Find this property's details under [Common Properties](#).

Output Result Property

Find this property's details under [Common Properties](#).

Detach Property

Find this property's details under [Common Properties](#).

Detach Timeout Property

Find this property's details under [Common Properties](#).

Condition Property

Find this property's details under [Common Properties](#).

Logging Details Property

Find this property's details under [Common Properties](#).

Log Level Property

Find this property's details under [Common Properties](#).

Enable Status Property

Find this property's details under [Common Properties](#).

ORS Extensions Property

Starting with 8.1.4, Composer blocks used to build routing applications (with the exception of the Disconnect and EndParallel blocks) add a new [ORS Extensions](#) property.

Email Forward Block

Use to send an incoming e-mail to an external address, such as for agent collaboration. This block combines the functionality of IRD's Forward E-mail, Redirect E-mail, and Reply E-mail from External Resource objects. The **Forward Type property** specifies the type of functionality by allowing you to select Forward, Reply to Customer, or Redirect.

- The difference between Forward and Redirect is as follows: Use the Forward functionality when there is an expectation of getting a response back. Use the Redirect functionality when there is no expectation of getting a response back.
- Reply To Customer works with the Forward functionality. It takes the resulting external resource reply inbound e-mail as input, extracts the external resource reply text from it, creates a customer reply outbound e-mail, and submits the e-mail to Interaction Server using the specified interaction queue.

Note: An "external resource" is a name for any object outside the contact center. It may be an external agent or another contact center. Configure external e-mail addresses as E-Mail Accounts Business Attributes in the Configuration Database.

Use Case for Forward and Reply to Customer

1. An e-mail about a product defect arrives to the contact center, initiating a routing workflow.
2. Based on content analysis, the contact center determines that it must be replied to by an outsource partner responsible for supporting the defective product.
3. The routing workflow invokes the Forward functionality of this block, and the e-mail is sent to an external address. The e-mail uses text from the Standard Response Library to indicate to the outsourcer what the service-level agreement is on such customer inquiries.
4. The outsourcer partner replies to the e-mail with a response on the defective product.
5. The routing workflow then employs the Reply to Customer capability. It take the response from the outsourcer partner, reformats it appropriately, and sends it as a response to the original customer inquiry.

Use Case for Redirect

Use the redirect functionality to send an incoming e-mail to an external address without expecting a response or when there is no need for further processing.

1. An inbound e-mail interaction initiates a routing workflow.
2. Based on a content analysis of the e-mail, the e-mail is re-directed to the Brokerage business unit that is outside of the contact center.
3. The e-mail is handled directly by a broker (knowledge worker) in the Brokerage business unit. The contact center does not expect a response, or to be involved in further processing of the email.

Special Note on Cc, From, and Exclude Addresses Properties

The Literal and Variable types can have a value set to an actual e-mail address, e.g., joe@test.com, or refer to the name of a previously configured e-mail address from Configuration Server (e.g., if Tech Support is configured as a Configuration Server E-mail Accounts Business Attribute, then Tech Support can be the value for the Literal type and the Orchestration platform will use that e-mail address.

The E-mail Forward block has the following properties:

Name Property

Find this property's details under [Common Properties](#).

Block Notes Property

Find this property's details under [Common Properties](#).

Email Server Property

Find this property's details under [Common Properties](#).

Exceptions Property

Find this property's details under [Common Properties](#).

Associate New Interaction Property

This property, introduced in Composer 8.1.420.xx for the Chat Transcript, Create Email, Create SMS, Email Forward, and Email Response blocks, supports the Orchestration Server `<ixn:createmessage>` tag associate attribute. See [Using eServices Blocks](#), section Associate New Interaction. This property requires Orchestration Server version 8.1.400.45+.

Do Not Thread Property

Find this property's details under [Common Properties](#).

Forward Type Property

As described at the start of this topic, select one of the following:

- **Forward**—forward to an external resource with the expectation of getting a response back
- **Reply to Customer**—takes the reply inbound e-mail as input, extracts the reply text from it, and creates a customer reply outbound e-mail
- **Redirect**—forward to an external resource with no expectation of getting a response back

Some of the properties under the **Message Settings** section may not be applicable based on the **Forward Type** selected. Even if you are able to specify a value for all properties, values for those properties that are not applicable are ignored. The table below provides you a list of the applicable and non-applicable properties for each **Forward Type**:

Forward Type	CC	Exclude Email Address	Field Codes	From	Include Original Message Into Reply	Standard Response	Subject	To
Forward	Yes	No	Yes	No	Yes	Yes	Yes	Yes
Reply To Customer	Yes	Yes	Yes	Yes	Yes	Yes	Yes	Yes
Redirect	Yes	Yes	Yes	No	Yes	No	Yes	Yes

Note: The not applicable properties will also not work when using an **External Service** block, based on the External Services Protocol.

Output Queue Property

Starting with Release 8.1.410.14, you can use a queue defined in referenced Projects. For more information, see [Adding an Interaction Queue](#).

Related Interaction ID

Select a variable for the current interaction ID or keep the default, which is `system.InteractionID`. For information on the value, see the Entry block, Variables property, System Variables.

CC Property

Find this property's details under [Common Properties](#).

Exclude Email Addresses Property

Find this property's details under [Common Properties](#).

Tip

When the **Forward Type** property is set to **Forward**, the **Exclude Email Address** property is not allowed. The **Add** button in the dialog box is disabled.

Field Codes Property

Find this property's details under [Common Properties](#).

From Property

Find this property's details under [Common Properties](#).

Include Original Message Into Reply Property

Find this property's details under [Common Properties](#).

Standard Response Property

Find this property's details under [Common Properties](#).

Subject Property

Find this property's details under [Common Properties](#).

To Property

Find this property's details under [Common Properties](#).

Interaction ID Property

Find this property's details under [Common Properties](#).

Output Result Property

Find this property's details under [Common Properties](#).

Detach Property

Find this property's details under [Common Properties](#).

Detach Timeout Property

Find this property's details under [Common Properties](#).

Condition Property

Find this property's details under [Common Properties](#).

Logging Details Property

Find this property's details under [Common Properties](#).

Log Level Property

Find this property's details under [Common Properties](#).

Enable Status Property

Find this property's details under [Common Properties](#).

ORS Extensions Property

Starting with 8.1.4, Composer blocks used to build routing applications (with the exception of the Disconnect and EndParallel blocks) add a new [ORS Extensions](#) property.

Email Response Block

Use to send an e-mail in response to incoming interaction resulting from inbound e-mail or an open media request. This block combines the functionality of IRD's Acknowledgement, Autoresponse, and Create Notification objects.

Autoresponse Use Case

1. An inbound e-mail initiates a routing workflow.
2. URS prioritizes the interaction,
3. The interaction is screened and customers are segmented based on tier.
4. If the screened e-mail is identified as one that does not require any agent input, then the e-mail is provided with autoresponse as an Re: with the text from to the original e-mail included
5. The next step in the routing workflow stops processing the interaction.

Acknowledgement Use Case

1. A Genesys user sends an e-mail request to create a ticket on specific problem involving a T-Server.
2. Genesys identifies the customer contact and sends out an acknowledgement e-mail.
3. The acknowledgement e-mail uses custom fields (Field Codes), personalizing a standard e-mail with the customer's name.
4. The acknowledgment e-mail also contains the ticket number and contact information for the technical support engineer assigned to the ticket .
5. The technical support engineer is also copied in on the email

Create Notification Use Case

Use Create Notification to create a notification e-mail that can be sent to a customer as a reply to an inquiry. (e.g phone call, e-mail, SMS, Chat, etc). This e-mail may itself contain the response to the inquiry or it may point the customer to the location of the information; for example, a page on the enterprise website, a link to youtube, and so on. And the e-mail can be classified as either Acknowledgement, Autoresponse or Notification. The response may be a template from knowledge management but not necessarily. Use case:

1. A Customer logs into a bank web site using his username and password.
2. The bank web site provides a way to send an inquiry to customer support.

3. The customer sends an inquiry to the bank's customer support, asking about the status of a check he had deposited yesterday through an ATM. He is wondering when the funds will be available to him through his account.
4. The customer support analyst provides a response to the customer. This response is only available to the customer through a secure log-in on the bank's web site, due to its sensitive nature.
5. The contact center also sends a notification email to the customer's Gmail address, telling him that there is a response awaiting him on the bank's website, providing a URL to that part of the bank's web site.
6. The customer logs into the bank's web site and retrieves the response to his inquiry.

Special Note on From and To Properties

The Literal and Variable types can have a value set to an actual e-mail address, e.g., joe@test.com, or refer to the name of a previously configured e-mail address from Configuration Server (e.g., if "Tech Support" is configured as a Configuration Server E-mail Accounts Business Attribute, then "Tech Support" can be the value for the Literal type and the platform will use that e-mail address).

The E-mail Response block has the following properties:

Name Property

Find this property's details under [Common Properties](#).

Block Notes Property

Find this property's details under [Common Properties](#).

Email Server Property

Find this property's details under [Common Properties](#).

Exceptions Property

Find this property's details under [Common Properties](#).

Associate New Interaction Property

This property, introduced in Composer 8.1.420.xx for the Chat Transcript, Create Email, Create SMS, Email Forward, and Email Response blocks, supports the Orchestration Server `<ixn:createmessage>` tag associate attribute. See [Using eServices Blocks](#), section Associate New Interaction. This property requires Orchestration Server version 8.1.400.45+.

Do Not Thread Property

Find this property's details under [Common Properties](#).

Open Media Property

Select true or false to indicate if the e-mail response is a result of an incoming open media interaction. Note: If you select true, this Email Server property above should reflect the e-mail server that has been adapted to handle the appropriate media type.

Output Queue Property

Find this property's details under [Common Properties](#).

Starting with Release 8.1.410.14, you can use a queue defined in referenced Projects. For more information, see [Adding an Interaction Queue](#).

Response Type Property

Select one of the following Interaction Subtypes:

- **Acknowledgement**
- **Autoresponse**
- **Notification**

For more information, see the [Create Notification Use Case](#) section above.

Some of the **Properties** under the **Message Settings** section may not be applicable based on the **Response Type** selected. Even if you are able to specify a value for all properties, values for those properties that are not applicable are ignored. The table below provides you a list of the applicable and non-applicable properties for each **Response Type**:

Response Type	CC	Exclude Email Addresses	Field Codes	From	Include Original Message Into Reply	Standard Response	Subject	To
Autoresponse	Yes	Yes	Yes	Yes	Yes	Yes	Yes	Yes
Acknowledgement	Yes	Yes	Yes	Yes	Yes	Yes	Yes	Yes
Notification	No	No	Yes	Yes	Yes	Yes	Yes	Yes

Note: The not applicable properties will also not work when using an **External Service** block, based on the External Services Protocol.

CC Property

Find this property's details under [Common Properties](#).

Exclude Email Addresses Property

Find this property's details under [Common Properties](#).

Field Codes Property

Find this property's details under [Common Properties](#).

From Property

Find this property's details under [Common Properties](#).

Include Original Message Into Reply Property

Find this property's details under [Common Properties](#).

Standard Response Property

Find this property's details under [Common Properties](#).

Subject Property

Find this property's details under [Common Properties](#).

To Property

Find this property's details under [Common Properties](#).

Use Subject From SRL Property

Find this property's details under [Common Properties](#).

Interaction ID Property

Find this property's details under [Common Properties](#).

Output Result Property

Find this property's details under [Common Properties](#).

Detach Property

Find this property's details under [Common Properties](#).

Detach Timeout Property

Find this property's details under [Common Properties](#).

Condition Property

Find this property's details under [Common Properties](#).

Logging Details Property

Find this property's details under [Common Properties](#).

Log Level Property

Find this property's details under [Common Properties](#).

Enable Status Property

Find this property's details under [Common Properties](#).

ORS Extensions Property

Starting with 8.1.4, Composer blocks used to build routing applications (with the exception of the Disconnect and EndParallel blocks) add a new [ORS Extensions](#) property.

Find Interactions Block

Introduced in 8.1.440.18. Applicable for workflow diagrams only. Execution of this block causes ORS to generate a request to Interaction Server for the method `FindInteractions` to get the list of interactions matching some specific condition (Condition Property). This block is useful in complex scenarios where you need to be able to find the targeted interaction among the pool of all currently existing interactions in [Interaction Server](#); for example:

- Where you need to make decisions regarding processing of one interaction based on data from another interaction.
- If, while processing one interaction, you want to update another interaction.

The interaction you are looking for may be a parent interaction, an interaction from the same customer, and so on.

The Find Interactions block has the following properties:

Name Property

Find this property's details under [Common Properties](#).

Block Notes Property

Find this property's details under [Common Properties](#).

Exceptions Property

Find this property's details under [Common Properties](#). The following events are supported:

```
error.session.fetch  
error.com.genesyslab.composer.invalid.requestdata  
error.com.genesyslab.composer.missing.interactionid  
error.com.genesyslab.composer.invalid.type  
error.com.genesyslab.composer.unknown.tenant  
error.com.genesyslab.composer.database.execution.failure  
error.com.genesyslab.composer.invalid.condition
```

Condition Property

Find this property's details under [Common Properties](#).

Logging Details Property

Find this property's details under [Common Properties](#).

Log Level Property

Find this property's details under [Common Properties](#).

ORS Extensions Property

Starting with 8.1.4, Composer blocks used to build routing applications (with the exception of the Disconnect and EndParallel blocks) add an [ORS Extensions](#) property. In order to view this property, click the Show Advanced Properties button.

Have More Interactions

Select the variable to hold the Boolean value indicating whether more records are available. Composer uses the variable as output for the block.

Interactions

Select the variable to hold the list of retrieved Interactions (JSON) object). Composer uses the variable as output for the block.

Condition

Enter a WHERE clause or select a variable to hold the WHERE clause to be used in a SQL statement to query interactions.

Example: `MediaType= 'chat' and ParentId is NULL`
If not specified, all interactions in the Tenant are returned.

Get Identifiers Only

Select `true` to receive only interaction IDs in the results. If `false`, the results include an interactions list with full properties.

Interaction Server

Select Configuration Server and the name (if connected to Configuration Server). You can also enter a literal or select a variable to specify the Interaction Server Application object in the Configuration Server.

Maximum Number of Interactions

Specify a positive integer value to limit the number of interactions returned in the result. If not specified, one interaction will be returned in the result.

Order

Enter a literal or variable to specify an ORDER clause to be used in a SQL statement to query interactions. If not specified, interactions are sorted by received_at and then by Id.

Tenant

Select the variable for the interaction Tenant. Find this property's details under [Common Properties](#).

Enable Status Property

Find this property's details under [Common Properties](#).

Identify Contact Block

Use to identify a contact based on the user data of the current interaction.

Prior to using this block, set [Context Services Preferences](#).

- For detailed information on how Universal Contact Server identifies customers, see the [Context Services User's Guide](#).

Also see:

- [Getting and Using E-mail Addresses](#).
- [Using the Identify Contact and Identify Customer Blocks](#).

Use Case

1. An inbound interaction initiates a routing workflow.
2. Based on user data attached to the interaction, the contact is identified from Universal Contact Server (UCS), and the interaction's user data is updated.
3. The user data is then assigned to variables and is then used to provide an automated response that is personalized with the First Name, Last Name and the contact address of the contact.

The Identify Customer block has the following properties. The behavior of some properties can vary depending on whether you are in [offline or online mode](#).

Name Property

Find this property's details under [CommonPropertiesforWorkflowBlocks](#).

Block Notes Property

Find this property's details under [CommonPropertiesforWorkflowBlocks](#).

Exceptions Property

Find this property's details under [CommonProperties](#).

You can also define [custom events](#).

Customer Count Property

Click the down arrow under **Value** to select a variable whose value is the number of customer records returned by Universal Contact Server. This feature is for your convenience. It also serves the purpose of retaining the original number of records returned in case the returned data is modified through other blocks.

Condition Property

Find this property's details under [Common Properties](#).

Logging Details Property

Find this property's details under [Common Properties](#).

Log Level Property

Find this property's details under [Common Properties](#).

Interaction ID Property

Find this property's details under [Common Properties](#).

Contact Count Property

Use to specify a variable to hold the number of matching contacts if more than one is found.

Contact Created Property

If no existing contact matches the data attached to an interaction, you can have a new contact created in Universal Contact Server Database. Select the variable to hold the new contact information.

Contact List Property

Select the variable to hold all matching contact records found.

Result Property

Find this property's details under [Common Properties](#).

Variables Mapping Property

Use this property to map the JSON data returned by this block to variables. See the [Variables Mapping](#) topic for details.

Create Contact Property

Select true or false. Based on attributes that match data attached to the interaction being processed by the strategy, if no existing contact matches the data attached to an interaction, use this property to have a new contact created in the Universal Contact Server database.

Return Unique Property

Select true or false. Use this property to have UCS return the list of matching Contact's ID only if a single matching contact record is found. By default it will return data for all matching contact records found.

Tenant Property

Find this property's details under [Common Properties](#).

Universal Contact Server Property

Find this property's details under [Common Properties](#).

Update Interaction User Data Property

Select true or false. Use to update certain attributes of the contact from values (literal or application variables) specified by the user instead of values from the user data. Also see [Common Properties](#).

Update User Data Property

Select true or false. Use to update the UCS database record of the matching contact with information from the current interaction's user data. Also see [Common Properties](#).

Enable Status Property

Find this property's details under [Common Properties](#).

ORS Extensions Property

Starting with 8.1.4, Composer blocks used to build routing applications (with the exception of the Disconnect and EndParallel blocks) add a new [ORS Extensions](#) property.

Render Message Block

Use the Render Message block to request Universal Contact Server to create message content. You can create message content using text from either the Message Text to Render property, the Result property, or User Data. This block causes Universal Routing Server to generate a request to Universal Contact Server for the method RenderMessageContent. The primary reason for this block is to create message content for use in the [Create SMS block](#), which does not allow you to use either Standard Response Library text or Field Codes when defining the message text.

Important! See [Mandatory Data for UCS Blocks](#).

Accessing the Rendered Message

The results of this request to the Universal Contact Server can be accessed by the Composer developer in two ways. You may:

- Assign the result to an application variable.
- Have the result attached to the current interaction.

Use Case

1. An inbound e-mail interaction initiates a routing strategy (routing workflow).
2. The e-mail is classified based on the email subject and keywords.
3. The routing workflow logic creates a message to send to the customer by SMS. The SMS message text is rendered by pulling data from the Standard Response Library, using Field Codes to insert the customer's name into the message text.
4. The SMS interaction is created in the routing workflow and then sent to the customer.

The Render Message block has the following properties:

Name Property

Find this property's details under [Common Properties](#).

Block Notes Property

Find this property's details under [Common Properties](#).

Exceptions Property

Find this property's details under [Common Properties](#). Also see [Exception_Events_for_eServices_UCS_Blocks](#). Exceptions supported: 105, 201, 203, 510, 701, 710, 716, 732.

Interaction ID Property

Find this property's details under [Common Properties](#).



Result Property

Click the down arrow under Value and select the variable to hold the rendered text.

- When the **Message Text to Render** property is **Variable**, **Literal**, **UserData** or **UserDataVariable**, the Result variable holds the rendered text.
- When the **Message Text to Render** property is **ConfigServer**, the Result variable holds a JSON object having the three properties: Subject, Text and StructuredText.



Field Codes Property

When using a standard response to render message text, use this property to assign values to Field Code variables that have been defined in Knowledge Manager (as described in the eServices 8.1 User's Guide) and used in that standard response. Universal Contact Server requires values for Field Codes when using standard responses that include Field Codes.

1. Click under Value to display the  button.
2. Click the  button to open the Field Codes dialog box.
3. Click **Add**. A second dialog box opens for specifying Field Codes and values.
4. Type the name of the Field Code.
5. Select **Literal** or **Variable**.
 - If you select **Variable**, select the variable the contains the Field Code value.
 - If you select **Literal**, enter the value for the Field Code.

Message Text to Render Property

Use to specify the content to be rendered using Universal Contact Server.

1. Click under Value to display the  button.
2. Click the  button to open the Message Text to Render dialog box.
3. The next step depends on the source for the rendered text.
 - If you connected Configuration Server and wish to use a standard response, select **Configuration Server** from the **Type** dropdown menu. In the **Value** field, select the name of the standard response from the tree. Note: For a standard response to be selectable in this dialog box, you must first define it in Knowledge Manager for the same tenant selected when [connecting to Configuration Server](#). You must also approve its use and make it active. The Knowledge Manager procedures for setting the Acknowledgement and Approved flags, and making the standard response Active are covered the *eServices 8.1 User's Guide*. See "Filling Out the Additional Tab" in the chapter on Knowledge Management Basics.
 - To type the rendered text, select **Literal** and enter the text in the **Value** field.
 - To have the rendered text taken from the interaction's User Data, select **UserData**. In the **Value** field, enter the User Data keys.
 - To have the rendered text taken from a variable in the User Data, select **UserDataVariable**. In the **Value** field, select the name of the variable.
 - To have the rendered text taken from a **variable** (Project or Workflow), select **Variable**. In the **Value** field, select the name of the variable.

Tenant Property

Find this property's details under [Common Properties](#).

Universal Contact Server Property

Find this property's details under [Common Properties](#).

Update Interaction User Data Property

Find this property's details under [Common Properties](#).

Condition Property

Find this property's details under [Common Properties](#).

Logging Details Property

Find this property's details under [Common Properties](#).

Log Level Property

Find this property's details under [Common Properties](#).

Enable Status Property

Find this property's details under [Common Properties](#).

ORS Extensions Property

Starting with 8.1.4, Composer blocks used to build routing applications (with the exception of the Disconnect and EndParallel blocks) add a new [ORS Extensions](#) property.

Screen Interaction Block

Use this block to filter a text-based interaction for specific content (specific words or patterns) based on evaluation of one or more screening rules by Classification Server. You then have the option of segmenting incoming interactions to different logical branches based on the result of the screening query. Screening rules are created in Knowledge Manager as described in the *eServices 8.1 User's Guide*.

Key-Value Pairs

If Classification Server finds a match, it returns a response that contains the following:

Key	Value
ScreenRuleName	The name of the screening rule.
Id	The actual identifier of the screening rule in the UCS Database.
ScreenRuleMatch	True (if Classification Server finds a match), or False (if it does not find a match).

Use Case

1. An e-mail arrives on a route point, initiating a routing workflow.
2. The e-mail is screened for an account number
3. If a screening rule match is found, the e-mail is provided with an auto-response and then queued to specific queue.
4. If no screening rule match is found, the e-mail is moved to a workbin of the starter agent group.
5. If the e-mail processing or screening itself fails, then interactions are moved to an general interaction queue.

The Screen Interaction block has the following properties:

Name Property

Find this property's details under [Common Properties](#).

Block Notes Property

Find this property's details under [Common Properties](#).

Exceptions Property

Find this property's details under [Common Properties](#).

Classification Categories Property

Use to select the location to store resulting classification categories after classification.

1. Click under Value to display the ... button.
2. Click the ... button to open the Classification Categories dialog box.
3. For Type, select **User Data** or **Variable**.
 - If you select **Variable**, select the variable that contains the key-value pairs to add to the interaction's User Data.
 - If you select **User Data**, specify the key-value pairs to add to the interaction's User Data. The key-value pairs are added to the Interaction's User Data with a prefix of `gdata:udata/` during runtime.

Key Value Pairs Property

Select the location to store the resulting key-value pairs after screening rules are applied.

1. Click under Value to display the ... button.
2. Click the ... button to open the Key-Value Pairs dialog box.
3. For Type, select **User Data** or **Variable**.
 - If you select **User Data**, specify the key-value pairs to add to the interaction's User Data. The key-value pairs are added to the Interaction's User Data with a prefix of `gdata:udata/` during runtime.
 - If you select **Variable**, select the variable that contains the key-value pairs to add to the interaction's User Data.

Matching Rules Property

Select the location to store the IDs of the matched rules and the keywords that matched after screening rules are applied.

1. Click under Value to display the ... button.
2. Click the ... button to open the Matching Rules dialog box.
3. For Type, select **User Data** or **Variable**.
 - If you select **User Data**, specify the key-value pairs to add to the interaction's User Data. The key-value pairs are added to the Interaction's User Data with a prefix of gdata:udata/ during runtime.
 - If you select **Variable**, select the variable for storing the matched rules and keywords.

Result Type Property

Click the down arrow and select the type of screening result:

- **All**--Select to return screening rule IDs, key-value pairs, and categories.
- **Rules**--Select if you wish to apply all screening rules.
- **Matching Pairs**--Select to return matched pairs of Screening Rule IDs and specific strings of words in the e-mail that matched the screening rules. Classification Server can return specific strings that were matched during the screening process. For example a rule screening for credit card numbers could return the following key-value pair: "Key_credit_number" "1111-2222-3333-4444"
- **Categories**--Select to return only the classification categories associated with the screening rules. This can be used later in the strategy to select a Standard Response.

Classification Server Property

Select the Application name for the Classification Server from those in the Configuration Database. If a Classification Server is not selected, the platform will internally select one.

1. Click under **Value** to display the ... button.
2. Click the ... button to open the Application Selection dialog box.
3. The next step depends on whether you are connected to Configuration Server.
 - If you are connected, select **Configuration Server** from the **Type** dropdown menu. Select the name of the Classification Server from the **Value** field. Otherwise:
 - You can select **Literal** and enter the name of the classification server in the **Value** field.
 - You can select **Variable** and select the variable from the **Value** field.

Generate Outports Property

Use to segment interactions to take different paths. Select **true** or **false**. When set to true, Composer will generate one outport for each selected screening rule. If the screening data matches the screening rule, then the processing will continue via the corresponding screening rule.

Language Property

Click the down arrow to select the language of the incoming interaction. The selected language determines which screening rules are shown. You must select a language in order for code to be generated.

1. Click under **Value** to display the ... button.
2. Click the ... button to open the Language dialog box.
3. The next step depends on whether you are connected to Configuration Server.
 - If you are connected and want to select a language defined as a Business Attribute in the Configuration Database, select **Configuration Server**. A tree of languages appears in the **Value** field for selection. Otherwise:
 - You can select **Literal** and enter the name of the language in the **Value** field.
 - You can select **Variable** and select the variable that contains the language from the **Value** field.

Root Category Property

Select the name of the top-level category to be used for the classification.

1. Click under Value to display the ... button.
2. Click the ... button to open the Root Category dialog box.
3. The next step depends on whether you are connected to Configuration Server.
 - If you are connected, select **Configuration Server** from the Type dropdown menu. A tree of classification categories appears in the **Value** field. Select the name of the top-level (root) classification category. This is a directory that appears in Configuration Manager in the Business Attributes > Category Structure folder. For more information on Root folders, see the *Universal Routing 8.1 Reference Manual*. Otherwise:
 - You can select **Literal** and enter the name of the root category in the **Value** field.
 - You can select **Variable** and select the variable that contains the root category from the **Value** field.

Screening Data Property

Use this property to select whether to search for screening data in the interaction's User Data, from a variable, or from the UCS database. This property works with the Screening Rules property below.

1. Click under **Value** to display the ... button.
2. Click the ... button to open the Screening Data dialog box.
3. For **Type**:
 - Select **UCS** to have Classification Server take the screening data from the UCS Database. Leave the **Value** field empty.
 - Select **User Data** to have Classification Server take screening data from the UCS Database. Leave the **Value** field empty.
 - Select **Variable** to have Classification Server take the screening data from a variable. Select the variable.

Screening Rules Property

Use to specify the screening rules to apply on the screening data specified above.

1. Click under **Value** to display the ... button.
2. Click the ... button to open the Screening Rules dialog box.
3. Click **Add** to open the Select Items dialog box.
4. From the **Type** dropdown menu, do one of the following:
 - If you are [connected to Configuration Server](#), select **Configuration Server**. Select one or more screening rules for the **Value**.
 - Select **Literal** and enter the screening rule IDs in the **Value** field. Use commas to separate the screening rule IDs.
 - Select **Variable** and select the variable that contains the screening rule IDs from the **Value** field.

Condition Property

Find this property's details under [Common Properties](#).

Logging Details Property

Find this property's details under [Common Properties](#).

Log Level Property

Find this property's details under [Common Properties](#).

Enable Status Property

Find this property's details under [Common Properties](#).

ORS Extensions Property

Starting with 8.1.4, Composer blocks used to build routing applications (with the exception of the Disconnect and EndParallel blocks) add a new [ORS Extensions](#) property.

Send Email Block

Use this block to send an e-mail waiting in a queue that was previously created using the [Create Email](#) block. Note: The Send Email block should only be used if the output queue ([Create Email block](#)) property is set. If this property is not set, the Orchestration platform will automatically send the e-mail via an internal Orchestration queue, and therefore the Send Email block is not needed.

Special Note on Cc, From, and Exclude Addresses Properties

The Literal and Variable types can have a value set to an actual e-mail address, e.g., joe@test.com, or refer to the name of a previously configured e-mail address from Configuration Server (e.g., if Tech Support is configured as a Configuration Server E-mail Accounts Business Attribute, then Tech Support can be the value for the Literal type and the platform will use that e-mail address).

Important

For the Create Email, Email Forward, Email Response, Send Email, Chat Transcript and CreateSMS blocks, Orchestration Server does not copy User Data from any Interaction into an outgoing ESP request. Currently there is no attribute support to overwrite this behavior. If User Data must be included as part of the above blocks, use [External Service blocks](#) or [SCXML State blocks](#) to directly call the ESP methods (`\\CFGEmailServer\\Email\\Forward` and `\\CFGEmailServer\\Email\\Send`).

The Send E-mail block has the following properties:

Name Property

Find this property's details under [Common Properties](#).

Block Notes Property

Find this property's details under [Common Properties](#).

Email Server Property

Find this property's details under [Common Properties](#).

E-mail to Send Property

Select the variable containing the e-mail to send.

Message Delivery Notification Property

Select true or false to indicate if the message being sent should include a request for a return message indicating whether and how the original message was delivered.

- If one of the SMTP servers involved in the transport of the original e-mail fails to deliver it, the return message will come into the system with Configuration Database Interaction Subtype InboundNDR. It contains no additional information.
- If the original e-mail is successfully delivered, the return message will come into the system with a Configuration Database Interaction Subtype InboundReport. It uses attached data to indicate delivery statuses such as delayed, delivered, relayed, and so on.

For details on Interaction Subtype handling, see the E-mail Server Java: Advanced Topics section of the *Ongoing Administration and Other Topics* chapter of the *eServices/Multimedia 8.1 User's Guide*.

Message Disposition Notification Property

Select **true** or **false** to indicate if the message should include a request for a return message indicating what happened to the original message after it was delivered. For example, the return message may indicate whether the original message was displayed, printed, deleted without displaying, and so on.

Exceptions Property

Find this property's details under [Common Properties](#).

CC Property

Find this property's details under [Common Properties](#).

Exclude Email Addresses Property



Find this property's details under [Common Properties](#).

From Property

Find this property's details under [Common Properties](#).

Header Fields Property

Use this property to specify additional message headers through a list of key-value pairs of literal values or application variables. Header fields are used to add/overwrite headers to the e-mail message when it is sent. They are passed to E-mail Server and the latter will create the e-mail message with these custom headers and will take the form of `<headername>:<headervalue>`. Examples of typical header names are: Received, Return-Path, X-MIMETrack, Subject, Sender, From, To, Cc, Bcc To enter the Header Fields property:

1. Click under Value to display the  button.
2. Click the  button to open the Header Fields dialog box.
3. Click **Add** to open the Key Value Pairs dialog box.
4. For **Key**, enter a key (see above description).
5. For **Value**, enter the literal value or select a variable for the value. The Header Fields dialog box reflects your entry.

Subject Property

Use this property to override the subject specified in the [Create E-mail block](#). Enter the Subject line of the e-mail.

Condition Property

Find this property's details under [Common Properties](#).

Logging Details Property

Find this property's details under [Common Properties](#).

Log Level Property

Find this property's details under [Common Properties](#).

Enable Status Property

Find this property's details under [Common Properties](#).

ORS Extensions Property

Starting with 8.1.4, Composer blocks used to build routing applications (with the exception of the Disconnect and EndParallel blocks) add a new [ORS Extensions](#) property.

Send SMS Block

Tip

For an example of how this block could be used, see [How To Automate an SMS Response to a Customer Call](#).

Use this block to send an Short Message Service (SMS) message created with the [Create SMS](#) block. This version of Composer supports native SMS, which means that the SMS message is sent via SMS Server and not via an e-mail to SMS gateway.

Important

The Send SMS block should only be used if the interaction queue ([Create SMS block](#)) property is set. If this property is not set, the Orchestration platform will automatically send the SMS via an internal Orchestration queue, and therefore the Send SMS block is not needed.

For the Create Email, Email Forward, Email Response, Send Email, Chat Transcript, and CreateSMS blocks, Orchestration Server does not copy User Data from any Interaction into an outgoing ESP request. Currently there is no attribute support to overwrite this behavior. If User Data must be included as part of the above blocks, use [External Service blocks](#) or [SCXML State blocks](#) to directly call the ESP methods (\\CFGEmailServer\\Email\\Forward and \\CFGEmailServer\\Email\\Send).

The Send E-mail block has the following properties:

Name Property



Find this property's details under [Common Properties](#).

Block Notes Property

Find this property's details under [Common Properties](#).

SMS Server Property

Select an SMS Server to send the message.

1. Click under Value to display the  button.
2. Click the  button to open the Select SMS Server dialog box.
3. The next step depends on whether you are connected to Configuration Server. Otherwise:
 - If you are connected, select **Configuration Server** from the **Type** dropdown menu. Select the name of the SMS Server object from the **Value** field.
 - You can select **Literal** and enter the name of the server in the **Value** field.
 - You can select **Variable** and select the variable from the **Value** field that contains the name of the server.

SMS to Send Property



Select the variable containing the message to send.

Exceptions Property

Find this property's details under [Common Properties](#).

Message Source Number Property

Use this property to override the Message Source Number specified in the Create SMS Block, which is the mobile telephone number from which the SMS message should appear to come.

1. Click under **Value** to display the  button.
2. Click the  button to open the Select the SMS Message Source Number dialog box.
3. From the **Type** dropdown menu, do one of the following:
 - If you are [connected to Configuration Server](#), select **Configuration Server**. Select a Configuration Server Business Attribute for **Value**.
 - Select **Literal** and enter the Cc address in the **Value** field.
 - Select **Variable** and select the variable that contains the number from the **Value** field.

Condition Property

Find this property's details under [Common Properties](#).

Logging Details Property

Find this property's details under [Common Properties](#).

Log Level Property

Find this property's details under [Common Properties](#).

Enable Status Property

Find this property's details under [Common Properties](#).

ORS Extensions Property

Starting with 8.1.4, Composer blocks used to build routing applications (with the exception of the Disconnect and EndParallel blocks) add a new [ORS Extensions](#) property.

Set Agent State Block

Introduced in 8.1.440.18, this block is applicable for workflow diagrams only. Use this block to dynamically manage agent resource states via [ESP methods](#). Using this block, you can:

- Set an agent Do Not Disturb (DND) state (on/off) for an agent based on their Agent ID or Place ID.
- Set an agent media state (ready/not ready) based on Agent ID, Place ID, and Media Type.
- Force agent logout (printable or result) based on Agent ID and Place ID.

For background information on these states, refer to the [Universal Routing 8.1 Business Process User Guide](#), section Workforce and Resource Management.

The Set Agent State block has the following properties:

Name Property

This is the block name in the diagram. Find this property's details under [Common Properties for Workflow Blocks](#).

Block Notes Property

Find this property's details under [Common Properties for Workflow Blocks](#).

Exceptions Property

Find this property's details under [Common Properties for Workflow Blocks](#). There are no default exceptions for this block.

Condition Property

Find this property's details under [Common Properties for Workflow Blocks](#).

Logging Details Property

Find this property's details under [Common Properties for Workflow Blocks](#).

Log Level Property

Find this property's details under [Common Properties for Workflow Blocks](#).

Agent Property

This property is mandatory if the Place property is not configured. Specify the agent (CfgPerson) in Configuration Server whose state is to be changed.

1. Click the ... under **Value**.
2. In the dialog box under **Type**, do one of the following:
 - Select **Configuration Server**. If [connected to Configuration Server](#), you can then select an AgentEmployeeid under **Value**.
 - Select **Literal** and manually enter the AgentEmployeeid.
 - Select the variable that contains the AgentEmployeeid.

Interaction Server Property

Select the Interaction Server Application Object (InteractionServerAppName). This property is mandatory if the Agent property is not configured. Specify the Place in Configuration Server whose state is to be changed.

1. Click the ... under **Value**.
2. In the dialog box under **Type**, do one of the following:
 - Select **Configuration Server**. If [connected to Configuration Server](#), you can then select an Interaction Server under **Value**.*
 - Select **Literal** and manually enter the Interaction Server name.
 - Select the variable that contains the Interaction Server name.

Method Property

Enter the name of the agent method to be invoked.

1. Click the ... under **Value**.
2. Select one of the following: SetAgentDNDState, SetAgentMediaState, or ForceLogout. Or select the variable that contains one of these methods.

Parameters Property

Specify the list of input parameters (auto-populated based on method type).

1. Click ... under **Value** to open a dialog box.
2. Click **Add** in the dialog box.
3. Select the **State**. If the method is SetAgentDNDState, select **on** or **off**. If the method is SelectAgentMediaState, select **ready** or **notready**. If the method is ForceLogout, select **printable** or **result**. For ForceLogout, the State parameter is unavailable.
4. Click **Add** again.
5. Add parameter 1 name and value. Use the parameter information in the links below.
6. Click **Add** again to define parameter 2.
7. Continue defining parameters in this fashion and click **OK** when finished.

[+] SetAgentDNDState

Use the Set Agent DND State method to turn the Agent's DND status on or off. If this is set to on, all of the agent's media that are controlled by Interaction Server will be reported as not accepting any interactions. If it is set to off, reported media status will be based on agent capacity rules. The State parameter is required for setting the Agent's DND state.

Method **SetAgentDNDState**

Parameters

- 'Place' - specifies name of the place to change DND state on
- 'Agent' - specifies agent employee id to change DND state; one of the 'Place' or 'Agent' has to be specified
- 'Tenant' - Specifies tenant identifier; the tenant will be inferred from the tenant identifier of the strategy that invokes the service. For multitenant clients, tenant identifier is mandatory.
- 'State' - specifies desired state; 1 - DND on, 0 - DND off

Limitations on method parameters

Parameter	Scope	Type	Required	Explanation
Tenant	Any tenant id, associated with this IxnServer	String or Int	Yes	tenant id
Place	Any string corresponding to place_id belonging to the specified tenant	String	If absent or empty, the place is inferred from agent id	place id
Agent	Any string corresponding to agent_id belonging to the specified tenant	String	If absent or empty ==> agent=anonymous	agent id
State	Ready or Not ready	String or Int	Yes	0=DNDOff 1=DNDOn

Error Codes

Error Code	Description
106	Invalid request
201	Missing parameter <name>
206	Unknown tenant
213	Invalid type of <parameter name>
218	Unknown value of parameter 'State'
229	Neither 'Place' nor 'Agent' is specified in the request
230	This agent is not logged in
501	Place not found
502	Place disabled
503	Place busy
505	Agent disabled
507	Place not occupied
508	Place not occupied by specified agent
509	Place not occupied by anonymous
516	DND already on
517	DND already off

[+] SetAgentMediaState

Use the Set Agent Media State method to change the state of the specified media to which the agent is logged on (if it is controlled by Interaction Server). If the media are set to Not Ready, it will be reported as not accepting any interactions. If the media are set to Ready, the status of the media will be reported based on agent capacity rules. The Media Type parameter is required for setting the Agent's media state. Select the media type from the predefined list.

Method **SetAgentMediaState**

Parameters

- 'Place' – specifies name of the place to change media state on
- 'Agent' – specifies agent employee id to change media state; one of the 'Place' or 'Agent' has to be specified
- 'Tenant' – TBD, specifies tenant identifier; the tenant will be inferred from the tenant identifier of the strategy that invokes the service. For multitenant clients, tenant identifier is mandatory.
- 'MediaType' – specifies name of the media to change state
- 'State' – specifies desired state; 1 – ready, 0 – not ready

Limitations on method parameters

Parameter	Scope	Type	Required	Explanation
Tenant	any tenant id, associated with this IxnServer	String or Int	Yes	tenant id
Place	Any string corresponding to place_id belonging to the specified tenant	String	If absent or empty, the place is inferred from agent id.	place id
Agent	Any string corresponding to agent_id belonging to the specified tenant	String	If absent or empty ==> agent=agent id, otherwise required	agent id
State	Ready or Not ready	String or Int	Yes	0=not ready, 1=ready
MediaType	any media loaded on the specified place	String	Yes	Media to be "ready"/"not ready"

Error Codes

Error Code	Description
106	Invalid request

201	Missing parameter <name>
206	Unknown tenant
213	Invalid type of <parameter name>
218	Unknown value of parameter 'State'
229	Neither 'Place' nor 'Agent' is specified in the request
230	This agent is not logged in
501	Place not found
502	Place disabled
503	Place busy
505	Agent disabled
507	Place not occupied
508	Place not occupied by specified agent
509	Place not occupied by anonymous
514	Agent does not have the media
518	Agent is already ready for media
519	Agent is already not ready for media

[+] ForceLogout

Use the Force Logout method to log out a Place or an Agent from all media that are controlled by Interaction Server. When this is done, the reported agent state will not contain any media that are supported by Interaction Server. There are no required parameters.

Method **ForceLogout**

Parameters

- 'Place' – specifies name of the place to be logged out
- 'Agent' – specifies agent employee id to be logged out; one of the 'Place' or 'Agent' has to be specified
- 'Tenant' – Specifies tenant identifier; the tenant will be inferred from the tenant identifier of the strategy that invokes the service. For multitenant clients, tenant identifier is mandatory.

Limitations on method parameters

Parameter	Scope	Type	Required	Explanation
Tenant	any tenant id, associated with this IxnServer	String or Int	Yes	tenant id
Place	any string corresponding to place_id belonging to the specified tenant	String	If absent or empty, the place is inferred from agent id.	place id
Agent	any string corresponding to agent_id belonging to the specified tenant	String	If absent or empty ==> agent=anonymous, otherwise	agent id

4.2.1.3. Error Codes

Error Code	Description
106	Invalid request
201	Missing parameter <name>
206	Unknown tenant
213	Invalid type of <parameter name>
218	Unknown value of parameter 'State'
229	Neither 'Place' nor 'Agent' is specified in the request
230	This agent is not logged in
501	Place not found

502	Place disabled
503	Place busy
505	Agent disabled
507	Place not occupied
508	Place not occupied by specified agent
509	Place not occupied by anonymous

Place Property

This property is mandatory if the Agent property is not configured. Specify the Place where the state is to be changed.

1. Click the ... under **Value**.
2. In the dialog box under **Type**, do one of the following:
 - Select **Configuration Server**. If **connected to Configuration Server**, you can then select a PPlaceName under **Value**.*
 - Select **Literal** and manually enter the PPlaceName.
 - Select the variable that contains the PPlaceName.

Tenant Property

Specify the Tenant DBID from Configuration Server (mandatory).

ORS Extensions Property

Starting with 8.1.4, Composer blocks used to build routing applications (with the exception of the Disconnect and EndParallel blocks) add a new **ORS Extensions** property.

Enable Status Property

Find this property's details under [Common Properties for Workflow Blocks](#).

Update Contact Block

Use this block to update customer profile information in the Universal Contact Server Database, based on data attached to an interaction. You may specify certain information to update by specifying certain key-value pairs that represent the data to update. If certain parameters are not specified, then all contact attributes will be updated by default, based on all user data available. Important! See [Mandatory User Data For UCS Blocks](#). Also see the section on Contact Identification and Creation in the *eServices 8.1 User's Guide*.

Use Case

1. A customer sends an e-mail to the contact center, initiating a routing workflow.
2. The routing workflow reads the user data from the e-mail.
3. The user data is used to identify that this customer is an existing contact in the UCS database based on the customer's first and last name
4. The routing workflow does a comparison of the customer's e-mail address in the e-mail, with the one in UCS database for this contact. They are different.
5. The routing workflow updates the contact information in the UCS database with the new email address

The Update Contact block has the following properties:

Name Property

Find this property's details under [Common Properties](#).

Exceptions Property



Find this property's details under [Context Services Exception Events](#). Also see [Exception Events for eServices UCS Blocks](#) where the following exceptions are supported: 201, 203, 502, 510, 701, 710, 716, 730.

Interaction ID Property

Find this property's details under [Common Properties](#).

Contact Attributes Property

Use this property to set the new contact attribute values.

1. Click under **Value** to display the  button.
2. Click the  button to open the Contact Attributes dialog box.
3. Click **Add** to open Configure Contact Attributes dialog box where you specify the attributes.
4. Click the down arrow opposite Name and select an attribute. You may select a user-defined attribute or a predefined attribute, such as:
 - **Contact ID**
 - **Customer ID**
 - **Customer Segment**
 - **E-mail Address**
 - **First Name**
 - **Last Name**
 - **Phone Number**
 - **PIN**
 - **Title**
5. Click the down arrow opposite **Type** and select **Literal** or **Variable**.
6. If you selected **Literal**, enter the **Value** field and click **OK**.
7. If you selected **Variable**, select the variable that contains the value and click **OK**. The Name and Value fields in the Configure Attributes dialog box reflect your entries.
8. Click **Add** again to continue entering customer attributes in this fashion.

Tenant Property Find this property's details under [Common Properties](#).

Universal Contact Server Property

Find this property's details under [Common Properties](#).

Use Contract Attributes Property

- Select **true** to have the new contact attribute values taken from the Contact Attributes property.
- Select **false** to have the new contact attributes values taken from the interaction's User Data.

Condition Property

Find this property's details under [Common Properties](#).

Logging Details Property

Find this property's details under [Common Properties](#).

Tenant Property

Find this property's details under [Common Properties](#).

Log Level Property

Find this property's details under [Common Properties](#).

Enable Status Property

Find this property's details under [Common Properties](#).

Update Interaction Block

Introduced in 8.1.440.18. Use to update properties of interaction(s) in the Interaction Server database including interaction(s) that are not currently being processed in the workflow. When ORS executes this block, it generates a request to Interaction Server for the method UpdateInteractions to update the interaction user data for the specified interaction using attributes specified in the Delete Attributes property or Update Interaction Attributes property.

The main use case is to update properties of the parent interaction (session or case). This object is used mostly in conjunction with the [Find Interactions block](#). For example, when you receive a reply onto an outbound e-mail, you can find the parent interaction and change its status to indicate that a reply was received.

Tip

Update Interaction sends a request to Interaction Server whereas [Update Contact](#) sends a request to Universal Contact Server.

The Update Interaction block has the following properties:

Name Property

Find this property's details under [Common Properties](#).

Block Notes Property

Find this property's details under [Common Properties](#).

Exceptions Property

Find this property's details under [Common Properties](#).

Condition Property

Find this property's details under [Common Properties](#).

Logging Details Property

Find this property's details under [Common Properties](#).

Log Level Property

Find this property's details under [Common Properties](#).

Delete Attributes Property

Tip

The Read-Only attributes of Interactions cannot be deleted. If those attributes are used in Delete Attributes, the following error will be displayed: Attempt to set/change read-only property.

Use this property to specify the interaction attributes to be deleted.

1. Click under **Value** to display the ... button.
2. Click the ... button to open the Delete Attributes dialog box.
3. Click **Add**.
4. Click the down arrow opposite **Value** and select **Literal** or **Variable**.
5. If you selected **Literal**, enter the **Value** field.
6. If you selected **Variable**, select the variable that contains the value.
7. Click **OK**. The Delete Attributes dialog box reflects your entries.
8. If applicable, click **Add** again to continue entering attributes in this fashion.

Interaction ID Property

Select the variable that contains the Interaction ID. The default variable is system.InteractionID. This is a required parameter that specifies the ID of the interaction to be updated. Find this property's details under [Common Properties](#).

Tenant Property

Find this property's details under [Common Properties](#).

Interaction Server Property

Specify the Interaction Server for the method UpdateInteraction.

1. Click under **Value** to display the ... button.
2. Click the ... button to open the Application Selection dialog box.
3. Click **Add**.
4. Click the down arrow opposite **Value** and select **Literal** or **Variable**.
5. If you selected Configuration Server, select the Interaction Server from the drop-down of the **Value** field and click **OK**.
6. If you selected **Literal**, enter the literal and click **OK**.
7. If you selected **Variable**, select the variable from the drop-down of the **Value** field and click **OK**.

Update Interaction Attributes Property

Use this property to specify the interaction attributes to be updated. For information on attributes that can be updated, see the *eServices Interaction Properties Reference Manual*, [Business Properties](#).

1. Click under **Value** to display the ... button.
2. Click the ... button to open the Contact Attributes dialog box.
3. Click **Add** to open Update Attributes dialog box where you specify key-value pairs.
4. Click the down arrow opposite **Value** and select **Literal** or **Variable**.
5. If you selected **Literal**, enter the **Value** field.
6. If you selected **Variable**, select the variable that contains the value.
7. Check the **Value is numeric** box if applicable.
8. Click **OK**. The Key and Value fields in the dialog box reflect your entries.
9. If applicable, click **Add** again to continue entering attributes in this fashion.

Enable Status Property

Find this property's details under [Common Properties](#).

Update UCS Record

Introduced in 81.440.18. Use this block to update the properties of an interaction in the Universal Contact Server database. Can be used for both interactions currently in process and interactions already processed. The execution of this block by ORS causes ORS to generate a request to Universal Contact Server for the method `UpdateInteraction`.

Use Case

1. A customer sends an e-mail to the contact center, initiating a routing workflow.
2. The routing workflow reads the user data from the e-mail.
3. The user data is used to identify that this customer is an existing contact in the UCS database based on the customer's first and last name
4. The routing workflow does a comparison of the customer's e-mail address in the e-mail, with the one in UCS database for this contact. They are different.
5. The routing workflow updates the contact information in the UCS database with the new email address.

The Update UCS Record block has the following properties:

Name Property

Find this property's details under [Common Properties](#).

Block Notes Property

Find this property's details under [Common Properties](#).

Exceptions Property

Find this property's details under [Common Properties](#). Also see: [Exception Events for eServices UCS Blocks](#) where the following exceptions are supported: 201, 203, 502, 510, 701, 710, 716, 730.

Condition Property

Find this property's details under [Common Properties](#).

Logging Details Property

Find this property's details under [Common Properties](#).

Log Level Property

Find this property's details under [Common Properties](#).

Enable Status Property

Find this property's details under [Common Properties](#).

Entity Type Property

You must select an Entity Type (other than Interaction) before you can enter the Update Entity Attributes property. Click the down arrow and select from the Entity Type list. Select Email In, Email Out, Chat, Phone Call, Callback, CoBrowse.

Interaction ID Property

Find this property's details under [Common Properties](#).

Tenant Property



Find this property's details under [Common Properties](#).

Universal Contact Server Property

Find this property's details under [Common Properties](#).

Update Entity Attributes

Use this property to set the parameters to be passed when updating entity attributes.

1. Click under **Value** to display the  button.
2. Click the  button to open the Contact Attributes dialog box.
3. Click **Add** to open the Update Entity Attributes dialog box where you specify the attributes.
4. Click the down arrow opposite **Value** and select **Literal** or **Variable**.
5. If you selected **Literal**, enter the **Value** field and click **OK**.
6. If you selected **Variable**, select the variable that contains the value and click **OK**. The Name and Value fields in the Update Entity Attributes dialog box reflect your entries.
7. Click **Add** again to continue entering Entity Attributes in this fashion.

[+] Entity Attributes

EmailIn Entity Attributes

BccAddresses
CcAddresses
EmailOutId
FromAddress
FromPersonal
Mailbox
ReplyToAddress
SendDate
ToAddresses
WhichRuleMatched

EmailOut Entity Attributes

BccAddresses
CcAddresses
FromAddress
FromPersonal
ReferenceId
ReplyToAddress
ReviewerId
SendDate
StandardResponseId
ToAddresses

Chat Entity Attributes

EstablishedDate
ReleaseDate

PhoneCall Entity Attributes

Duration
Outcome
PhoneNumber
TConnectionId



Callback Entity Attributes

Attempts
CallbackServerID
CallBackStatus

CallResult
CustomData
CustomerNumber
DesiredResponseType
DetailedDescription
DN
EndTime
Location
StartTime
TheType

Update Interaction Attributes Property

Use this property to set the parameters to be passed when updating interaction attributes.

1. Click under **Value** to display the  button.
2. Click the  button to open the Contact Attributes dialog box.
3. Click **Add** to open Update Interaction Attributes dialog box where you specify the attributes.
4. Click the down arrow opposite **Value** and select **Literal** or **Variable**.
5. If you selected **Literal**, enter the **Value** field and click **OK**.
6. If you selected **Variable**, select the variable that contains the value and click **OK**. The Name and Value fields in the Update Entity Attributes dialog box reflect your entries.
7. Click **Add** again to continue entering Interaction Attributes in this fashion.

[+] Interaction Attributes

Interaction Attributes
CanBeParent
CategoryId
ContactId
CreatorAppId
Custom
EndDate
ExternalId
IsCategoryApproved
IsSpam
Lang
OwnerId
ParentId
QueueName
StartDate
Status
StoppedReason
StructTextMimeType
StructuredText
Subject
SubtypeId
Text
TheComment

ThreadHash
ThreadId
Timeshift
TypeId
WebSafeEmailStatus

Enable Status Property

Find this property's details under [Common Properties](#).

Using eServices Blocks

This page contains general information on working with eServices blocks.

Example Multimedia Workflow

In general, an interaction process diagram (IPD) for multimedia interactions works like this:

1. A **media server** (such as E-mail Server Java) directs Interaction Server to place an interaction into an inbound interaction queue.
2. Using the **Views** property, the interaction is then taken out of the queue and submitted to a routing **workflow**.
3. The workflow performs specialized processing and eventually routes the interaction to a target, but not necessarily the final target. For example, an e-mail interaction may be placed in an agent queue for construction of a response.
4. The target processes the interaction and places it into another queue where another workflow may process it. For example, a workflow may send an agent's draft e-mail response to a queue for Quality Assurance checking.
5. The cycle of going from queue/view/workflow continues until processing is stopped or the interaction reaches some final (usually an outbound) queue.

Example Diagram

The figure below shows a sample multimedia workflow diagram in Composer Design **perspective**.

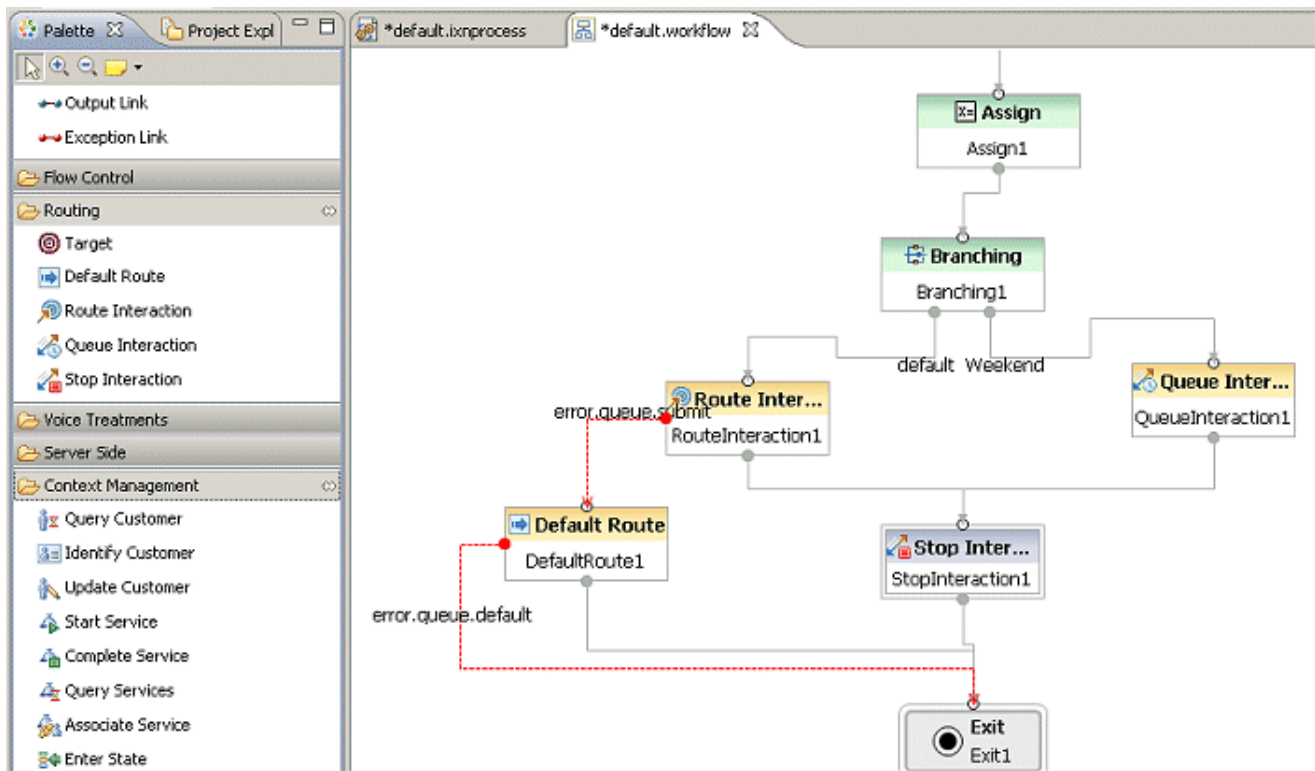

For other sample diagrams, see the [Sample Applications](#) topic. The default.workflow shown above works as follows:

- The Entry block defines a variable called Today.
- The Assign block gives a value to the Today variable. In Expression Builder this is defined as:

```
data.Today==(_genesys.session.day.Saturday) || (data.Today==_genesys.session.day.Sunday)
```

- The Branching block Conditions property contains an expression used for segmenting interactions based on whether today is a week day or the weekend. The expression determines whether an interaction goes to a queue for the weekend crew or whether it is routed to a target.
- The Stop block notifies Interaction Server to stop processing and whether to notify Universal Contact Server about the interaction.

Associated IPD

The figure below shows the IPD containing the Workflow block that points to the workflow diagram above. Three **work-flow generated blocks** are automatically generated in this example.

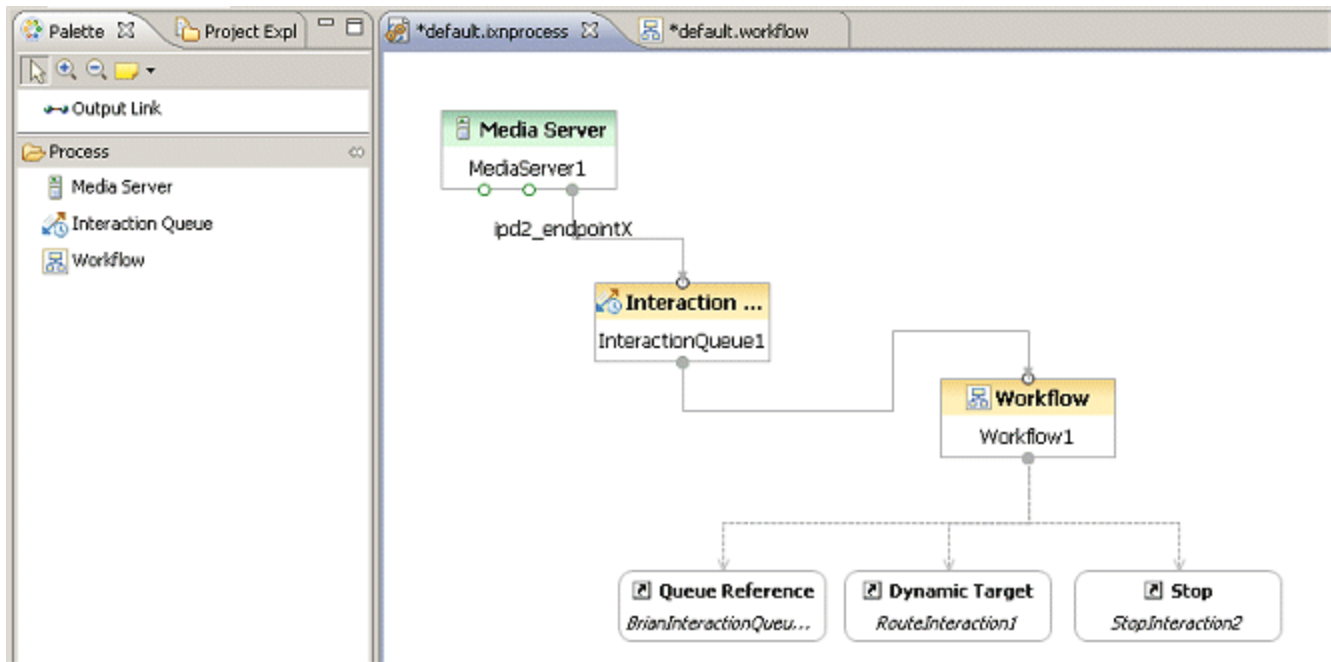

eService Preparation

Genesys eService/Multimedia lets you process non-voice interactions in your contact center. At the center of the collection of components are:

- Interaction Server: Works with Universal Routing Server and Stat Server to process non-voice interactions by executing **interaction process diagrams**.
- Universal Contact Server (UCS): Works with its database to deliver customer contact history and information to the agent desktop.
- In addition, there are a number of other Multimedia servers that facilitate the handling of non-voice media, including E-mail Server Java, SMS Server, and Chat Server.

This help system assumes you have already installed and configured the eService/Multimedia components as described in the *eService/Multimedia 8.1 Deployment Guide*.

Working with Returned Data

A few Composer Route blocks will return data back to the application:

- Email Response (**Output Result**)
- Create Email (**Output Result**)
- Create SMS (**Output Result**)

- Identify Customer
- Render Message ([Result Property](#))
- Query Customer ([Result Property](#))

Each qualifying block will expose an output result property (or equivalent) that will specify an application variable to store the results. These results will then be available in other blocks in the application for further processing. The format of returned data is usually JSON. Any post-processing work to be done on returned results can be done in the existing Assign block. It provides access to ECMAScript functions and supports writing simple or complex expressions to extract values out of JSON strings and arrays.

Mandatory User Data for UCS Blocks

When working with the Update Contact and Render Message blocks (which map to Universal Contact Server services), certain properties must exist in the interaction [User Data](#). These properties are:

- [Update Customer Block](#) ContactId
- [Render Message Block](#) ContactId (if some contact-related Field Codes (as described in the *eServices 8.1 User's Guide*) are used in the text to render); InteractionId (if some interaction-related Field Codes are used in the text to render); OwnerEmployeeId (if some agent-related Field Codes are used in the text to render).

As is the case with IRD, these properties are not set in the blocks themselves. Instead, the properties are assumed to be put in the interaction's User Data by some other block earlier in the workflow, such as the [Identify Customer block](#) or [Create Interaction block](#) with the Update User Data property set to true. In case no other block does this, the [User Data block](#) may be used for this purpose.

Important

If those properties are not available, an explicit UCS error message (missing parameter) shows in the Orchestration Server log.

Working with Child Interactions

The Composer Create Email, Email Forward, and Create SMS blocks create new interactions as part of block execution and these new interactions can be controlled using queue, detach and associate attributes. Optionally, these interactions can be queued to start a new workflow strategy. For details please refer to the comparison table below.

Detach Delay for New Interaction

While detaching a new interaction, in the case of an ACK or Response, it might take a few seconds to receive the new interaction. During this time, the application "Detach" loop logic could exceed the

Orchestration Server scxml/max-state-entry-count value. As a workaround in this case, set the ORS scxml/max-state-entry-count value higher than 150. 200 seems to be an optimal value.

Associate New Interaction

This property, introduced in Composer 8.1.420.14 for the Chat Transcript, Create Email, Create SMS, Email Forward, and Email Response blocks, supports the Orchestration Server `<ixn:createmessage>` tag associate attribute. This property requires Orchestration Server version 8.1.400.45+.

<ixn:createmessage> Attributes Behavior Comparisons

queue	associate	detach	runtime behavior	comments
Queue specified	true	true	Session will get <code>interaction.added</code> and <code>interaction.present</code> events for the new interaction.	New interaction detached from the session and does not get pulled automatically from the queue. Use a Queue Interaction block to manually queue the interaction.
Queue specified	true	false	Session will get <code>interaction.added</code> and <code>interaction.present</code> events for the new interaction.	ORS pulls the new interaction from the queue and starts new session.
Queue specified	false	true	Session will not get <code>interaction.added</code> and <code>interaction.present</code> events for the new interaction.	1. ORS pulls the new interaction from the queue and starts new session. 2. Detach operation is not possible in this case since the interaction is not associated with the session. Error message: 'No interaction with specified ID'
Queue specified	false	false	Session will not get <code>interaction.added</code> and <code>interaction.present</code> events for the new interaction.	ORS pulls the new interaction from the queue and starts new session.
No value	true/false	false	Session will not get <code>interaction.added</code>	Recommended approach by Platform

queue	associate	detach	runtime behavior	comments
			and interaction.present events for the new interaction. Platform automatically handles/sends the ixn using internal queue.	
No value	true/false	true	Session will not get interaction.added and interaction.present events for the new interaction.	Detach attempt will result in error. "Error message: No interaction with specified ID"

Note: If the "queue" attribute is not specified the associate attribute does not have any effect at all. Use the associate attribute to handle the interaction.

Detach - Handle interaction.deleted for the New Interaction

If you are using a Composer versions prior to 8.1.400.35, adding the `interaction.deleted` event in the Entry block would add a "condition-less" transition. This might handle the `interaction.deleted` event from the new interaction and ends/takes the error path for the workflow. Also, the automatically added `interaction.deleted` handler in the block, while setting `Detach` property to `true`, would ignore this new `interaction.deleted` event due to the `interactionId` condition check for the original interaction.

As a workaround in this case, add the following changes to the diagram.

In the block:

1. Create a User variable to collect the new interaction's `interactionID`.
2. Assign this new variable in the Output Result property to collect the result.
3. Open the Exceptions property in the block, and add the `interaction.deleted` event.
4. In the Configure Exceptions dialog, uncheck the Target box to make this a "target-less" transition.
5. Add the condition to check for the new interaction. (`_event.data.interactionid == varChildIxn`).

In the Entry Block:

Make sure the `interaction.deleted` event handler has the following condition set to handle the `interaction.deleted` event only if the original interaction was deleted and not as a result of the `Detach` operation:

```
_event.data.interactionid == system.InteractionID && (!_event.data.resultof ||  
_event.data.resultof == 'deletion')
```

Handling eServices Switchovers

Starting with Composer 8.1.400.20, Composer default interaction process diagram (IPD) event handlers use the `interaction.present` event (named `interaction` re-queued in the IPD **Events** dialog) to handle eServices server switchover scenarios, such as a **Chat Sever HA switchover**. The default behavior was changed to wait for another `interaction.present` event indicating that the interaction is again available to the current session for processing.

Composer 8.1.400.19 and Earlier

In previous versions of Composer (8.1.400.19 and earlier), the default behavior was to end the current session upon receiving `interaction.notcontrolled`. In such cases, upgrading to a newer version of Composer (8.1.400.33 or higher) will not replace this handler in existing IPDs even though it will add the handler for new IPDs.

Between Composer 8.1.400.20 and 8.1.400.32

To handle switchovers in versions between Composer 8.1.400.20 and 8.1.400.32, add the `interaction` re-queued event in your IPD **Events** dialog and then **Generate Code**. If upgrading to version 8.1.400.33 or higher, your event handlers are automatically upgraded to a "custom" set of handlers and your old events will be retained. For more information, refer to **Intra Version Upgrades**.

Custom Events

If you are using a custom event (for example, `interaction.notcontrolled`) to handle eServices/Interaction Server switchover or failover scenarios, please evaluate switching to the default event handler in the **Multimedia** category set of event handlers in the **Events** dialog.

ORS resultof Attribute

If you decide to stay with `interaction.notcontrolled`, then Orchestration Server Release 8.1.400.17 offers a newly added `resultof` attribute to the `interaction.notcontrolled` event in your event handler, which can be used to make the event handler more specific.

Examples:

```
_event.data.interactionid == system.InteractionID && (!_event.data.resultof ||  
_event.data.resultof == 'deletion')
```

`resultof` attribute descriptions:

`detaching` - interaction became `notcontrolled` because it was detached from a running session.

`deletion` - interaction became `notcontrolled` because it was deleted.

`routing` - interaction became `notcontrolled` because of ORS actions such as delivering to an agent, placing in a queue, etc. So an event with `resultof= routing` is an expected event in a session because it is a result of some actions of the strategy itself.

`revoking` - interaction being processed by ORS (pulled) is taken away from that ORS instance explicitly (by agent, by media server, by Interaction Server due to inactivity) or implicitly (disconnect from Interaction Server). In these cases, all previously pulled interactions are no longer considered as such. So an event with `resultof= revoking` is a kind of unexpected event in a session. Ideally, a session should be terminated upon receiving such event, but this is up to application developer.

How To: Automate an SMS Response to a Customer Call

This topic presents a very simple example of the Genesys “Omnichannel” capability, coordinating different media channels when a customer reaches out to your contact center. It will illustrate how you might automatically generate and send an SMS to a customer who had just made a voice call to your contact center, perhaps offering the caller a link to a survey or confirmation of the case number.

This example also shows how interactions from distinct media can be linked in a step-by-step workflow created in **Composer**, the Genesys tool that allows you to model your business. Composer-created workflows are executed by **Orchestration Server**, the Genesys engine that allows different media (voice, email, chat, SMS, and so on) to be coordinated and thereby enhance the customer experience. While the example here demonstrates a voice call synching with an SMS, you can also use Composer for many other types of Omnichannel routing.

Why Would I Use This?

The Building Blocks

This workflow diagram below was built with the following Composer blocks:

1. Entry and Exit blocks
2. Play Application block
3. Target block
4. SCXML State block
5. Create SMS block
6. Send SMS block

The Workflow Diagram

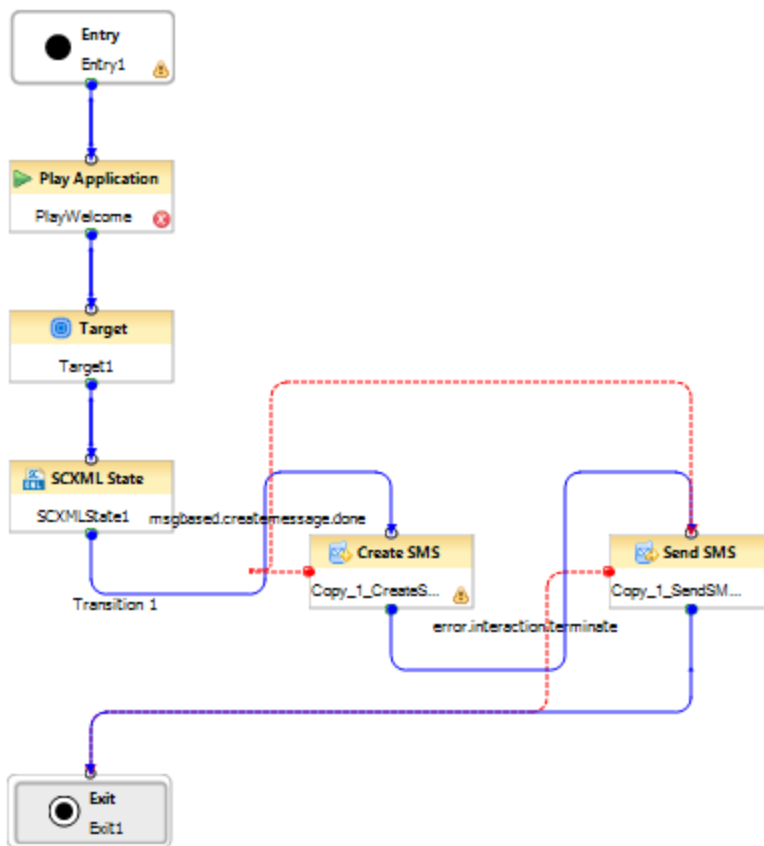

This is the finished workflow diagram that we will explore. The configuration for each block is shown further ahead. To start a diagram in Composer, select **New > Java Composer Project**, enter a name, select **Integrated Voice and Route** (in this case), then click **Finish**.

The diagram creation process goes like this: You drag and drop blocks from Composer's palette of blocks, configure the block properties, connect the blocks, **Save**, **Validate**, and **Generate** the code (SCXML).

Important

After you configure a block's properties, be sure to select **Save** from the **File** menu. Don't wait until you have configured all the blocks to save.

For more detail, see [Creating a New Routing Project](#).

Configuring the Entry Block

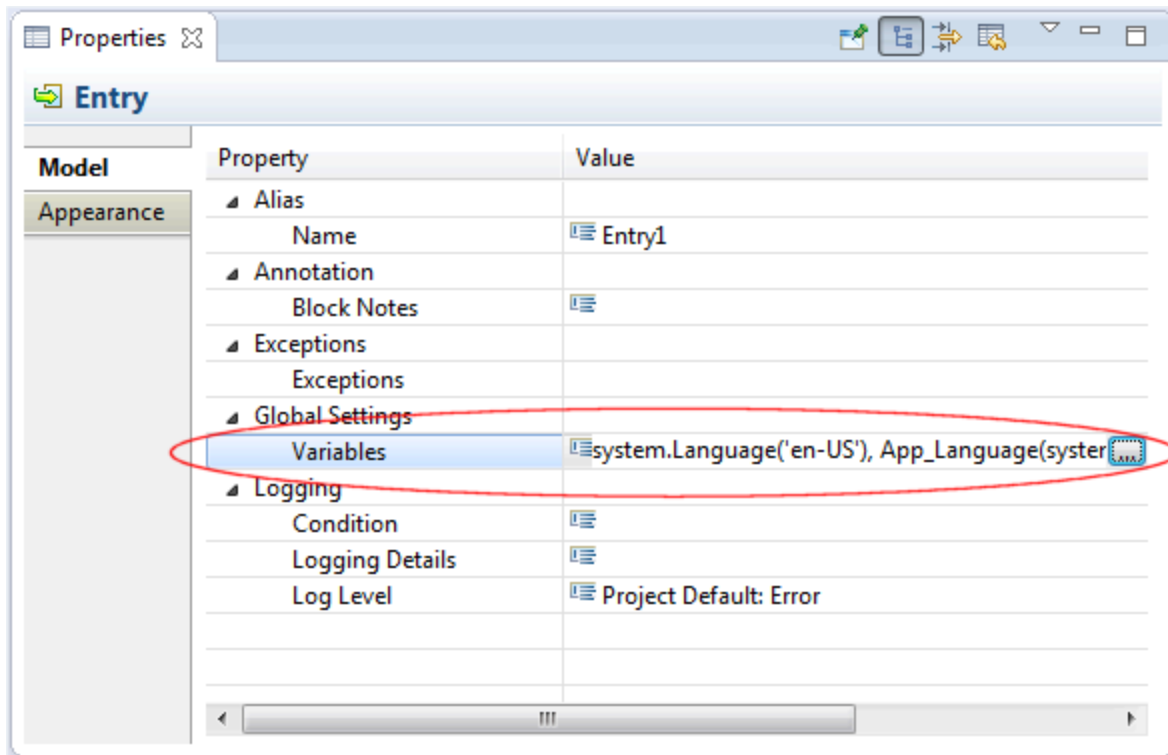

Note the **Entry block** at the top of the above diagram and the Exit block at the bottom. Every diagram starts with an Entry block and ends with an Exit block.

Workflow diagram-building blocks are contained in Composer's **palette** of blocks, which appears on the side of the **Composer UI**.

Each block has configurable *properties* (fields) associated with it. Dragging and dropping a block from the palette into the design area automatically opens a view for that block where you configure properties associated with the block. The Properties view shown opposite is for the Entry block. Selecting a block already placed in the design area also opens the Properties view for that block.

Configuring Entry Block Variables

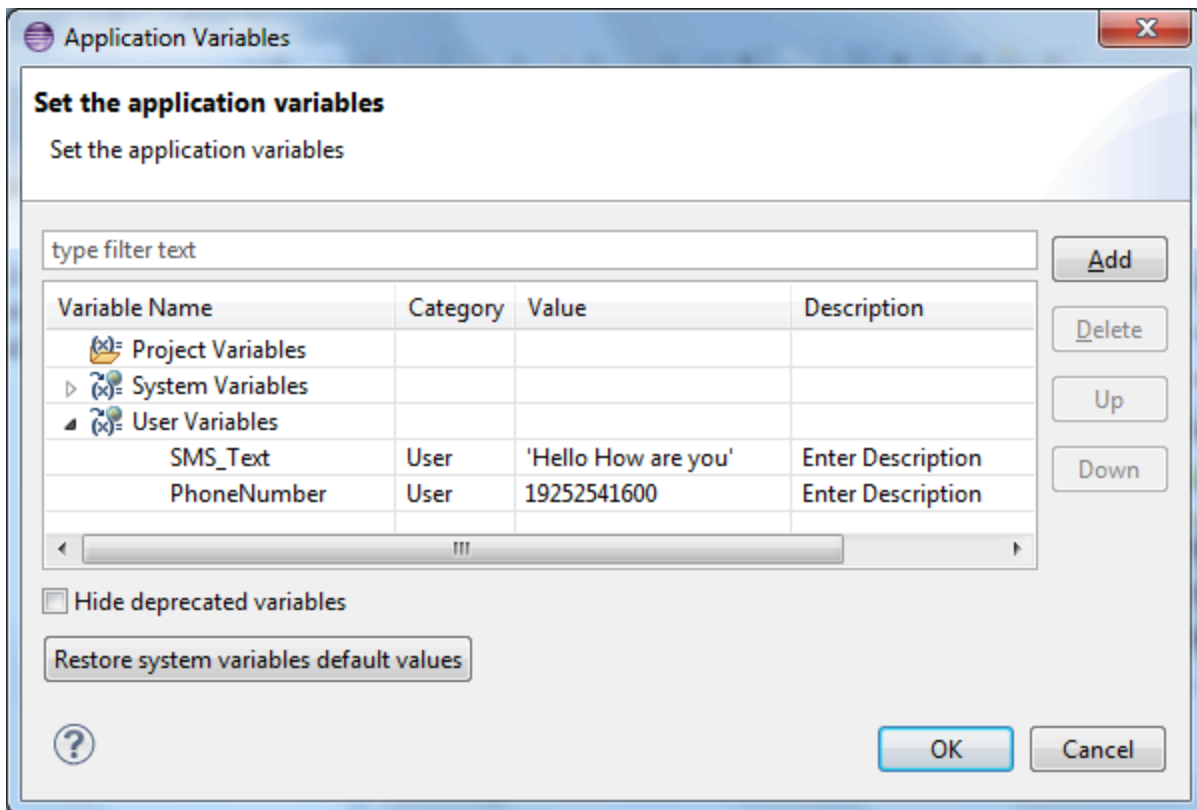

One function of the Entry block is to define **variables**. You open the dialog box shown on the left for defining variables by clicking the button opposite **Variables** (see Properties view above). You have the option of assigning values to predefined **System** and **Application** variables. Or you can define your own **User** variables.

The Variables dialog box in this example shows two user-defined variables defined: SMS_Text and PhoneNumber.

Configuring the Play Application Block

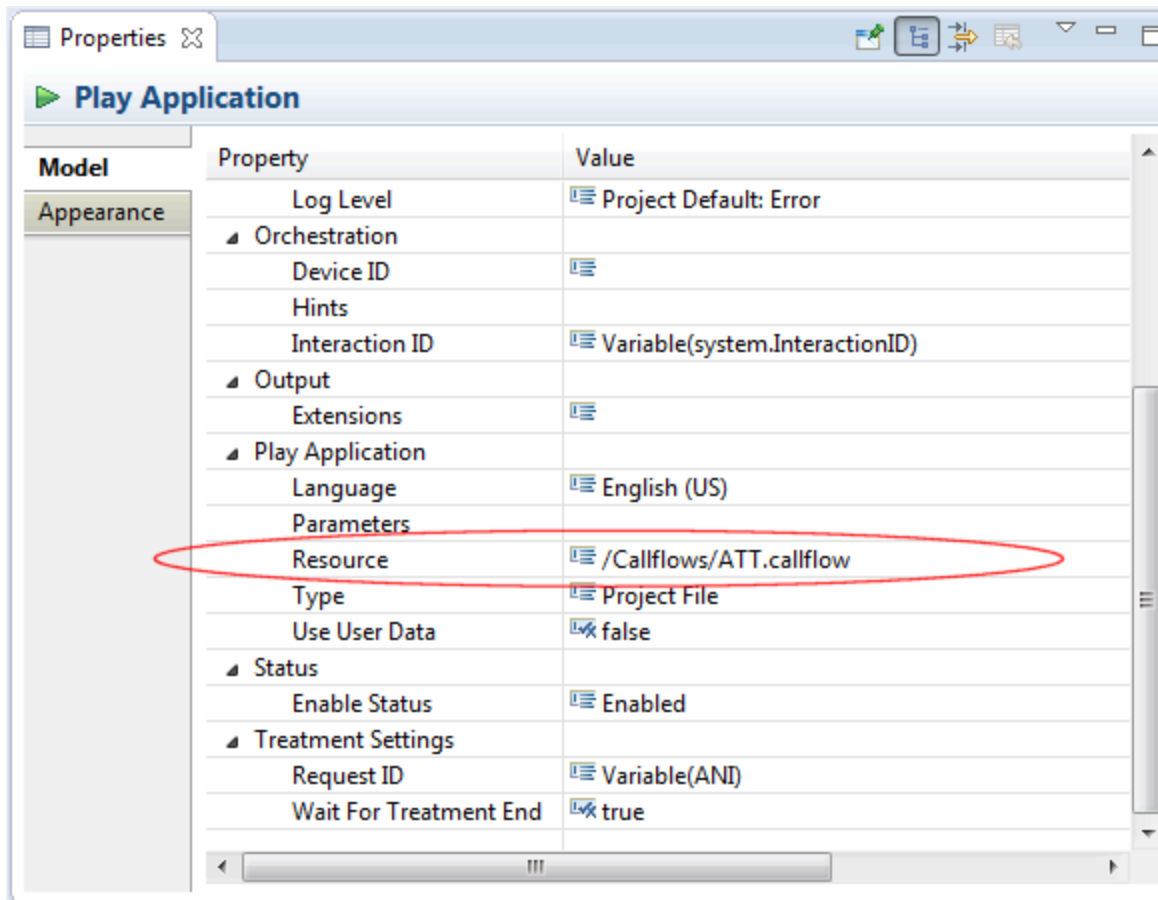

The second block in the diagram is a **Play Application block**. This block executes an application or a script on a device, such as an Interactive Voice Response unit (IVR).

In the example diagram, the Play Application block plays a voice recording to the calling customer. As shown by the Resource property, the Play Application block plays the recording associated with the ATT.callflow. This callflow would be part of the same **Project** file containing the workflow diagram being described here.

Configuring the Target Block

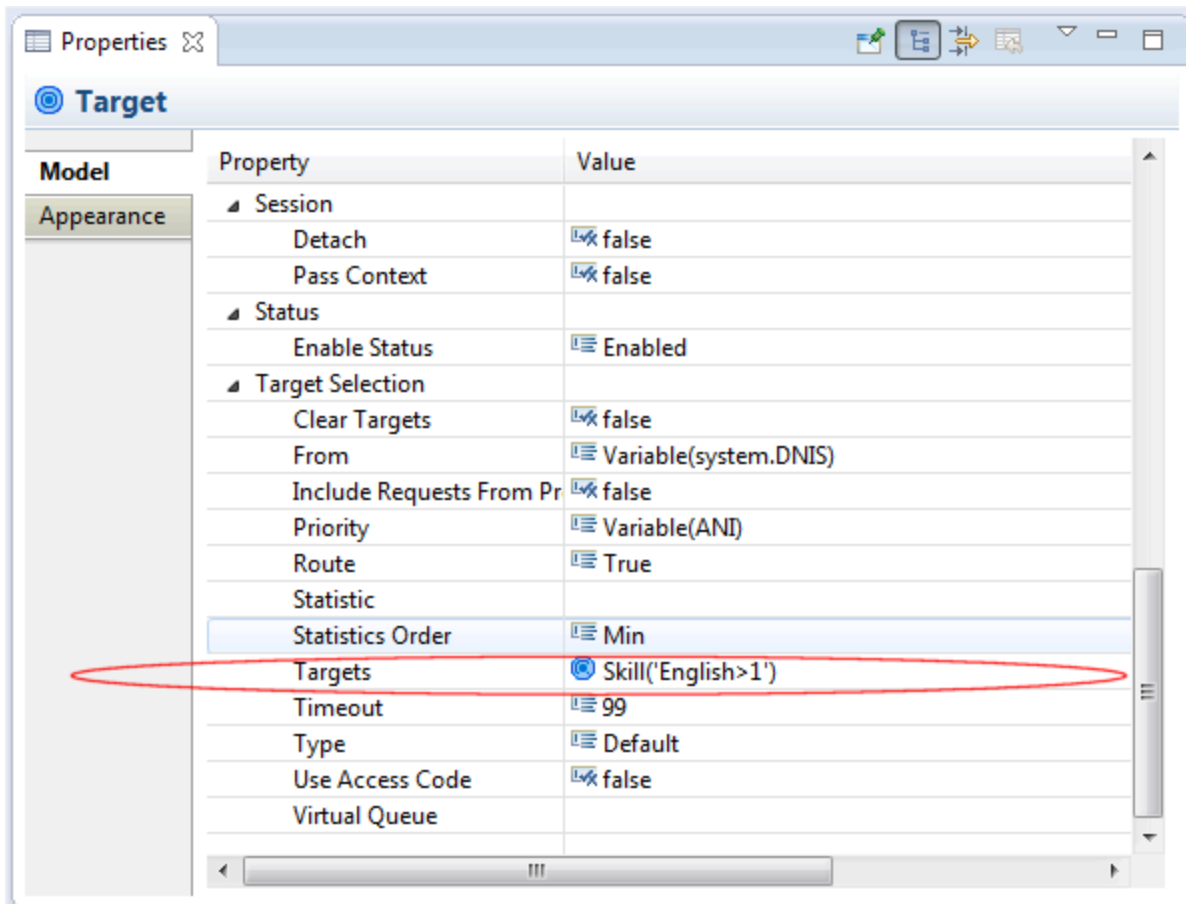

The third block in the diagram is a **Target block**. This block routes a customer interaction to to an agent based on the **Target Type criteria** you select. The Target block in our example diagram routes based on agent Skill. The **skill expression** shown for the Targets property instructs to route the interaction to an agent having an English Skill greater than "1".

Configuring the SCXML State Block

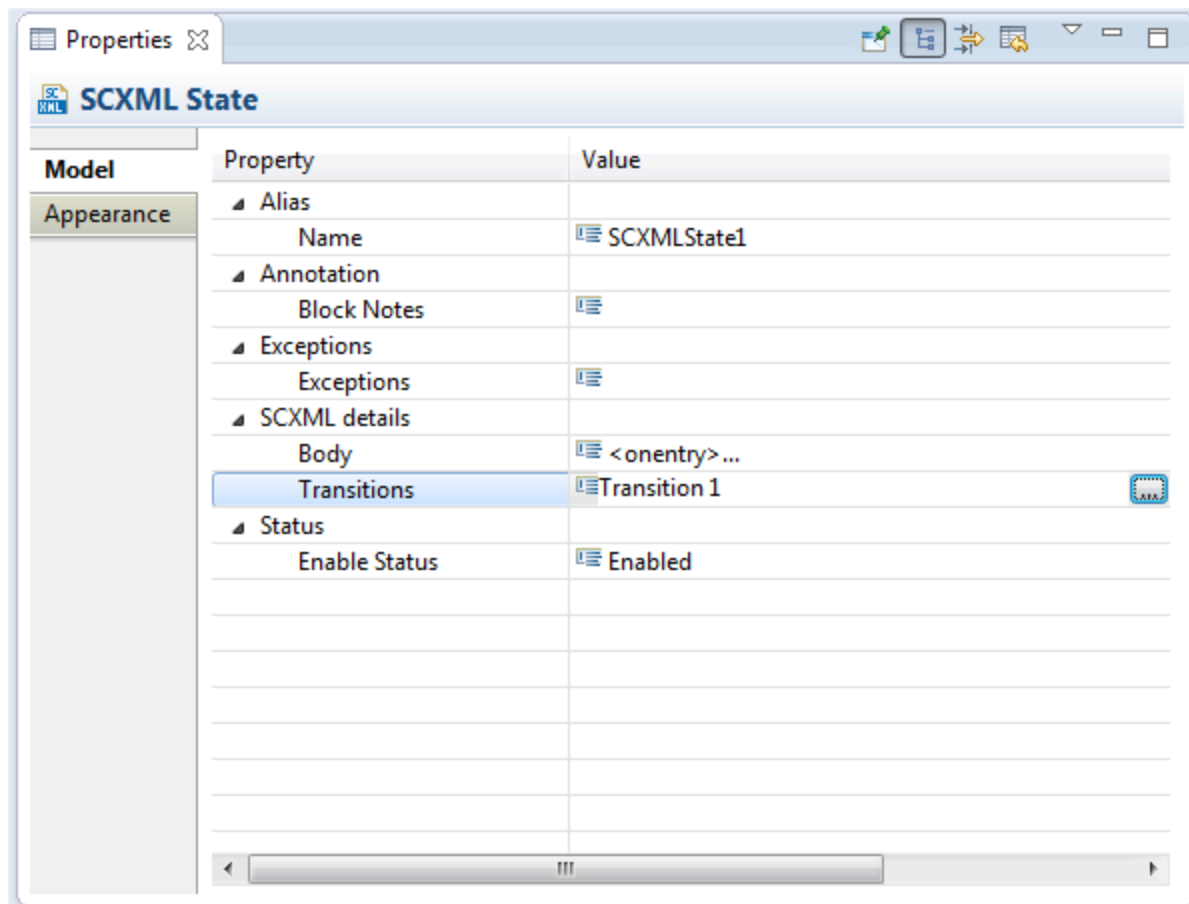

The fourth block in the diagram is a **SCXML State block**. This block gives the option of including custom code in the SCXML document that Composer generates based on the workflow diagram.

The SCXML State block in our example diagram contains Transitions 1 (a user-defined name) for the **Transitions Property** used for transitioning from voice to SMS. Clicking the button opposite the Transitions property shows Transition 1 defined as `interaction.deleted`.

[+] Background on SCXML

When you create a workflow diagram in Composer, the result is an SCXML-based routing strategy. Orchestration Server (ORS) executes these SCXML-based routing strategies. The ORS SCXML Engine supports a variety of Genesys-developed flow control SCXML elements and methods, which gives the option of creating more complex strategies. The *Orchestration Server Developer's Guide* documents these Genesys-specific elements and methods. If you need more information at this point, the `<transition>` element and `interaction.deleted` used in the example SCXML State block, are defined in section "Interaction Interface Action Elements" in the *Orchestration Server Developer's Guide*.

Note: The SCXMLState block has a Target previously defined for Transition 1 so it does not need the Body property. Although not shown here, there could be an output on the SCXML State block connected to another block that could provide logic to be executed when interaction.deleted is received.

Configuring the Create SMS Block

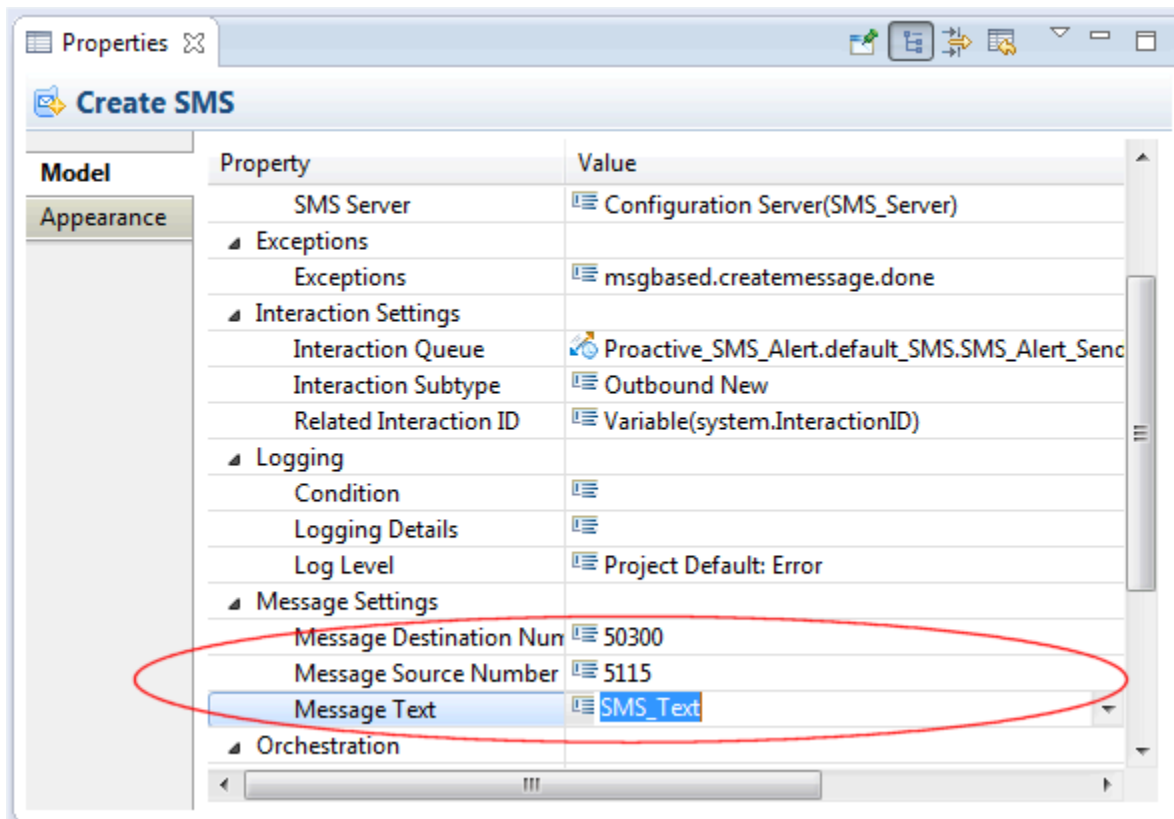

The fifth block in the diagram is a **Create SMS block** used to create an outbound message, which can be sent out as a Short Message Service (SMS) text to an external SMS Server. SMS refers to the common text messaging service available on cellphones and other handheld devices.

Block properties include the **Message Text**, **Outbound Queue** for the outbound message, the **Message Destination Number**, and the **Message Source Number**.

The Message Text can be manually entered or be contained in variable. The example diagram uses the SMS_Text variable previously defined in the **Entry block**.

Configuring the Send SMS Block

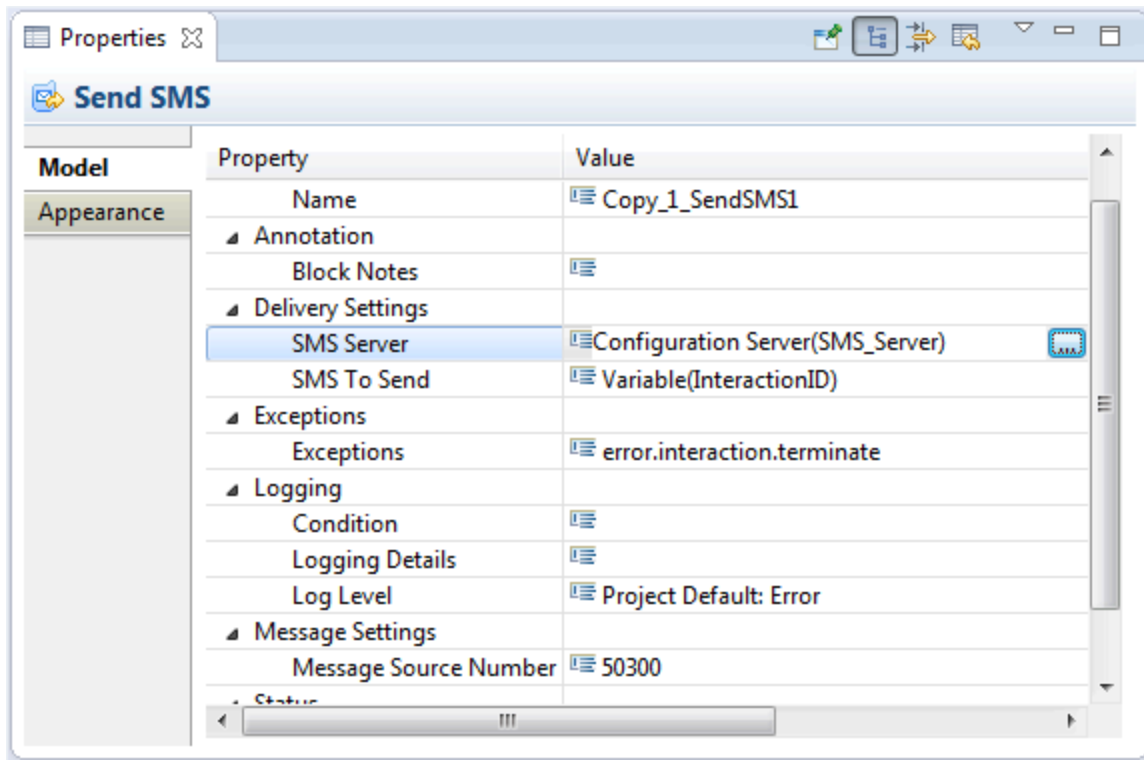

The sixth block in the diagram is a **Send SMS block**. This block sends the SMS message created with the Create SMS block to the SMS server.

Why Would I Use This?

There are number of reasons why you might want to configure this type of workflow where a calling customer is sent a text message. A few examples are presented below.

[+] IVR Cannot Handle

Your IVR cannot handle a particular type of customer inquiry:

1. A customer calls into the contact center IVR triggering self-service.
2. The customer requests a transaction that is not possible via the IVR and the the customer call is placed into a queue.
3. The customer abandons the queue.
4. An SMS is sent to the customer to start an SMS conversation with the contact center.
5. The customer can then reply via SMS when they are ready.
6. The SMS server can use its session capability to perform a SMS/chat with the customer or call the

customer back when appropriate.

[+] Last Call Agent Unavailable

The agent who last handled this customer's call is unavailable:

1. A customer calls into contact center and the routing strategy identifies this customer as one with a high risk of leaving.
2. The routing strategy is configured to allow the customer to be connected with the last called agent if they call back within the next XX days/hours/weeks.
3. The customer is directed to a "churn" agent who is trained to handle the this type of high risk situation.
4. The customer is sent an SMS with the agent details to personalize the experience and allow the customer to remember the details of the agent they last spoke with. As a result, if the customer calls back and the last agent for valid business reasons is not available to assist, then the customer knows exactly which agent they can request and a message can be left.

[+] Post-Call Survey

You might want to request a post-call survey:

1. A customer calls into contact center.
2. The routing strategy classifies the intention of the caller and identifies that the customer has a mobile phone that can receive an SMS.
3. The routing strategy selects the ideal agent for the customer inquiry.
4. The customer is routed to the ideal agent.
5. The customer is sent an SMS with a link to a post-call survey.

[Return to top.](#)

Common Properties for Workflow Blocks

The following properties are common to multiple blocks. Their descriptions are placed here to minimize duplication of content:

Block Notes Property

You have the option of entering a comment (see example).

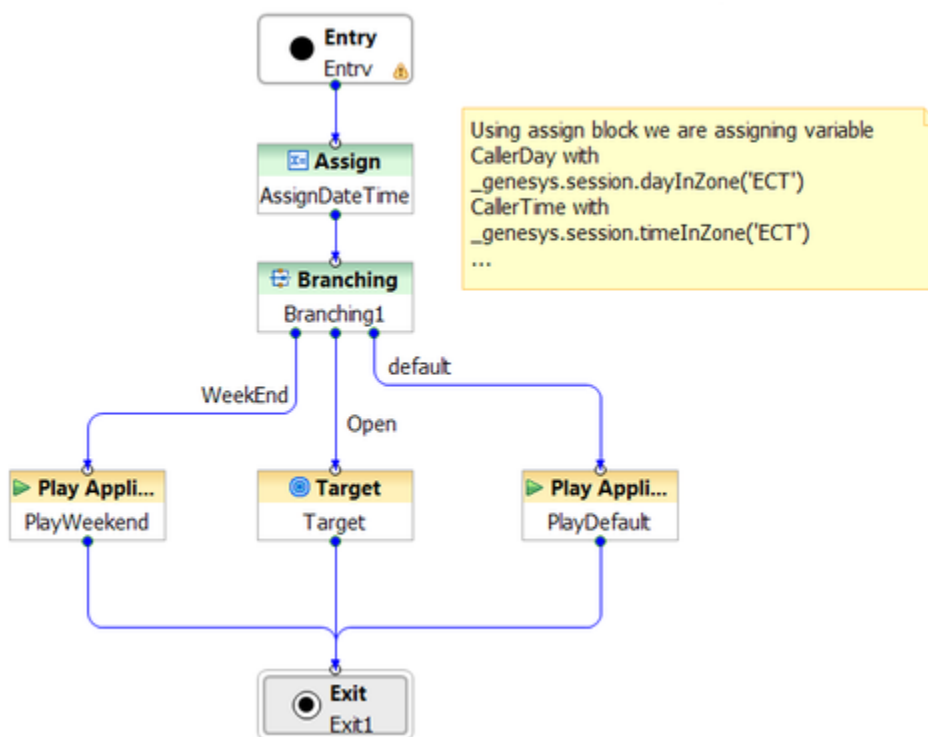

This property is the equivalent of the IRD Object Comments feature.

Categories Property

Use this property to select individual categories and sub-categories of the Root Category to be used in the classification process.

1. Click under **Value** to display the ... button and open the Categories dialog box.
2. Click **Add** to open the Select Items dialog box.

3. From the **Type** dropdown menu, do one of the following:

- If you are **connected to Configuration_Server**, select Configuration Server. Select one or more categories for the **Value**.
- Select **Literal** and enter the categories in the Value field. Use commas to separate the categories.
- Select **Variable** and select the variable that contains the categories from the Value field.

CC Property

Use this property to specify the CC addresses on the e-mail transmitting the chat transcript. The CC property is not allowed in the Email Response block when the Response Type property is set to Notification.

1. Click under **Value** to display the ... button and open the Select Cc Addresses dialog box.

2. Click **Add** to open the Select Items dialog box.

3. From the **Type** dropdown menu, do one of the following:

- If you are **connected to Configuration_Server**, select Configuration Server. Select a Configuration Server E-mail Accounts Business Attribute for the Value.
- Select **Literal** and enter the Cc address in the **Value** field.
- Select **Variable** and select the variable that contains the Cc address from the **Value** field.
- Select **Originating Email** and then select the value as **CC** or **To-all**. Originating Email is not applicable to the Email Forward (Forward type: Forward and Redirect), Send Email, and Chat transcript blocks.
- Select **User Data** as the Type and **EmailAddress** for a value. User Data is not applicable for the Send Email block.

5. If applicable, repeat the above steps to add another e-mail address.

6. Click **OK** to close the dialog box.

Condition Property

The Condition property indicates that the log will be active only if the given condition is true at runtime. To provide a condition setting for a log:

1. Select the **Condition** row in the block's property table.

2. Type the condition to evaluate against.

For example, assume in Entry block, there is a variable "MyVar==3". Assume also that you would like to log the session ID (GVPSessionID variable in Entry block) for all sessions where MyVar=3. In this case you must set the condition to "AppState.MyVar=3". If this condition is true, then GVPSessionID will be written to the log, otherwise it will be ignored.

Destination Property

Use this property to specify the routing destination.

1. Click under **Value** to display the ... button and open the Destination dialog box.
2. Select one of the following:
 - **Block Reference.** For Value, specify any Target or Route Interaction block in the diagram where the Route property is set to False. When Destination is set to a Route Interaction block, the block-generated SCXML code automatically uses the following Route Interaction block properties: [Queue For Existing Interaction](#) and [Queue For Outgoing Interaction](#).
 - **Literal.** For Value, you can specify:
 - An agent: <agent id>
 - A place: <place id>
 - A DN: <number>
 - An e-mail address: <username>@<host> or _origin or _origin.all or _udata
 - A customer number: <dn number>
 - A target format addresses: <Target DN>

See the [Orchestration Server Documentation Wiki](#) for those literals that apply to multimedia interactions only.

- **Variable.** If the variable contains a string, see Literal above. If the value is a JSON object, Value can refer to:
 - An agent: {agent: "<agent id>", type:"A"}
 - An agent group: {agent: "<name>", type:"AG"}
 - A place: {place: "<place id>", type:"AP"}
 - A place group: {place: "<name>", type:"PG"}
 - A DN: {dn: "<number>", type:"Q or RP or DN", switch:"<switch name>"}
 - An interaction queue: {id: "<q name>", type:"iq" }
 - A workbin: {id: "<wb name>", type:"wb"<owner>"}
 - A customer number: {dn: "<number>"}
 - A target format addresses: [Resource Object](#) from the queue.submit.done event (the Target Block [Resource Selected](#) property).

See the [Orchestration Server wiki](#) for those literals that apply to multimedia interactions only.

- **Configuration Server** to select the from Switch//DN if [connected](#).
- **Resource** to select a resource using properties that will form a JSON object.

4. Click **OK** to close the Destination dialog box.

Detach Property

Use for multi-site routing. Controls whether the Orchestration Platform should <detach> an interaction from the current session before sending the e-mail with the chat transcript. When this property is set to true, the interaction is detached from the current session. The Chat Transcript block will always <detach> the new interaction before continuing with the current interaction.

Detach Timeout Property

Use to specify how long to attempt to <detach> if an initial attempt fails with an invalidstate error. Specify the timeout in milliseconds. If set to 0, no further attempt to detach is made. After the timeout, if the <detach> is not successful, no further attempts will be made and the block will attempt to reclaim the interaction back into the current session using <attach>.

Do Not Thread Property

Select **true** to instruct NOT to thread under another interaction (which is specified under key ParentID in the User Data) in the contact's history in the Universal Contact Server Database.

Email Server Property

Note: This property is not mandatory as the platform will choose an e-mail server if not provided. Select the Application name for the E-mail Server that URS should notify about the e-mail (via Interaction Server).

1. Click under **Value** to display the ... button and open the **Application Selection** dialog box.
2. The next step depends on whether you are connected to Configuration Server.
 - If you are connected, select **Configuration Server** from the **Type** dropdown menu. Select the name of the E-mail Server Java object from the **Value** field.
 - You can also select **Literal** and enter the name of the e-mail server in the **Value** field.
 - You can also select **Variable** and select the variable from the **Value** field.

Enable Status Property

This property controls whether or not a block contributes code to the application. Diagrams visually indicate when a block is disabled. You may wish to use this property if there is a need to temporarily remove a block during debugging or, for other reasons during development, temporarily disable a block. This saves the effort of having to remove the block and then add it back later. You can also right-click a block and select **Toggle Enable Status**. The ORS Debugger skips over deactivated blocks.

Exceptions Property

Use this property to define which exceptions or events to handle.

1. Click opposite **Exceptions** under **Value**.
2. Click the ... button to bring up the Exceptions dialog box. The sample below shows the dialog with the `interaction.deleted` event selected.

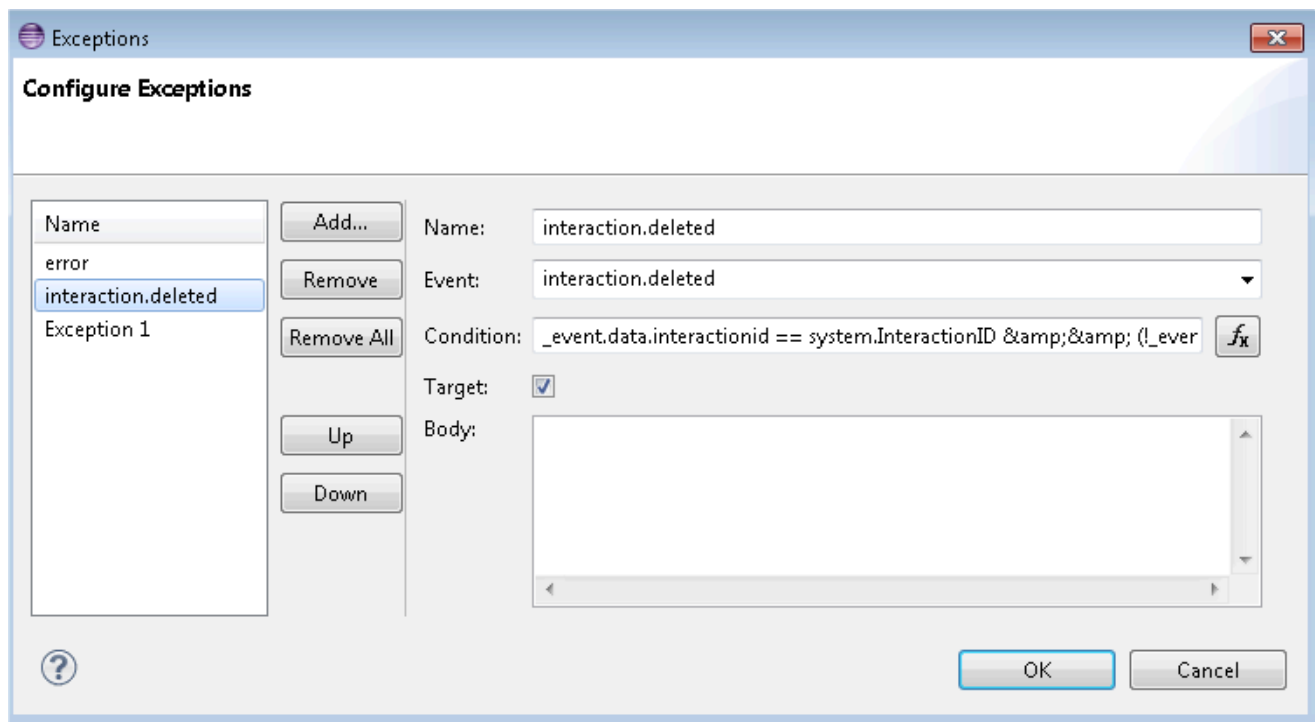

Starting with 8.1.410.14, a result of guard condition check is now made when processing eServices/child interactions. The Entry block `interaction.deleted` event handlers are updated with the following guard conditions:

- Current interaction deletion.
- The `interaction.deleted` event is from an interaction deletion and not from a detach operation.

```
_event.data.interactionid == system.InteractionID && (!_event.data.resultof ||
_event.data.resultof == 'deletion')
```

3. Click **Add** to add new exceptions/conditions.
4. For each exception, specify a unique name and an exception event. Also see [handling eServices Switchovers](#).
 - **Name**--Composer uses the name of the exception to label the output.
 - **Event**--Use to select the specific exception event.
 - **Condition**-- Added in 8.1.440.18. You have the option of entering a guard condition for this exception, which you define in [Expression Builder](#). The exception is selected only if the condition evaluates to true.
 - **Target**--If true, an exception port is created and the user can connect it to the block this exception will transition to when it is executed. If false, the exception will not cause a change in the state configuration when it is executed. The executable content contained in the exception will still be executed, so the exception will function as a simple exception event handler.
 - **Body**--(optional) Executable scxml code that will be executed when this event is received and any specified condition evaluates to true. This code is executed before any other blocks that are connected as this exception's event handlers.
5. When done with the dialog box, click **OK**.

Notes:

- Exceptions for Busy treatment blocks should be handled in the [Target block](#) to which they are connected and not in the Busy treatment blocks themselves. Busy treatment exceptions are raised as the `error.queue.submit` exception and not as exceptions listed in individual treatment blocks.
- Each block has its own predefined set of events on the Exceptions property dialog box. Genesys recommends that you not remove any of the predefined events from the **Supported** list.
- Before generating code, each supported event must be handled by connecting its red node on the side of the block to the inport (input node) of another block.
- The events in the [Entry block](#) are global in scope.
- Events defined in other blocks are local to that block only. When an event is thrown, if a handler for that event is declared in the current block, that local event handler is called.
- If there is no local event handler for the event, but there is a global event handler declared in the Entry block, then the global event handler from the Entry block is called.

Enable Status Property

This property controls whether or not a block contributes code to the application. You may wish to use this property if there is a need to temporarily remove a block during debugging or, for other reasons during development, temporarily disable a block. This saves the effort of having to remove the block and then add it back later. You can also right-click a block and select **Toggle Enabled Status**.

Exclude Email Addresses Property

When sending a response, you may not want the email to copy in all the addresses (To, From) in the original email. Use this property to exclude specific email addresses that need to be removed from the "To" and "Cc" fields. Exclude Email Address is not allowed in the Email Response block when the Response type property is set to Notification and the Email Forward block with the Forward type property set to Forward.

1. Click under **Value** to display the ... button and open the Exclude Addresses dialog box.
2. Click Add to open the Select Items dialog box.
3. From the **Type** dropdown menu, do one of the following:
 - Select **Literal** and enter the address to exclude in the **Value** field.
 - If you are **connected to Configuration Server**, select Configuration Server. Select a Configuration Server E-mail Accounts **Business Attribute** for the **Value**.
 - Select **Variable** and select the variable that contains the address to exclude from the **Value** field.
5. If applicable, repeat the above steps to add another e-mail address.
6. Click OK to close the dialog box.

Field Codes Property

When using a standard response to render message text, use this property to assign values to Field Code variables that have been defined in **Knowledge Manager** (as described in the *eServices 8.1 User's Guide*) and used in that standard response. **Universal Contact Server** requires values for Field Codes when using standard responses that include Field Codes.

1. Click under **Value** to display the ... button and open the **Field Codes** dialog box.
2. Click **Add**. A second dialog box opens for specifying Field Codes and values.
3. Type the name of the Field Code.
4. Select **Literal** or **Variable**.
 - If you select **Literal**, enter the value for the Field Code.
 - If you select **Variable**, select the variable the contains the Field Code Value.

From Property

Use this property to specify the address to appear in the "From" field of the outbound e-mail. The From property is not allowed in the Email Forward block when the Response Type property is set to Forward or Redirect.

1. Click under **Value** to display the ... button and open the **Select From E-mail Address** dialog box.
2. From the **Type** dropdown, you have the following options:
 - If you are **connected to Configuration Server**, select **Configuration Server** from the dropdown menu. Select the from address from the **Value** field in the form of an Configuration Server **E-mail Accounts** Business Attribute.
 - Select **Literal** from the dropdown menu and then enter the From address in the **Value** field.
 - Select **Originating Email** and then select the value as **To**. Originating Email is not applicable in the Email Response block of Response type: Notification, Email Forward block of Forward type: Forward and Redirect
 - Select **Variable** from the dropdown menu and then select the variable that contains the from address.
4. Click **OK** to close the dialog box.

Include Original Message Into Reply Property

Select **true** or **false** to indicate if the text from the parent interaction copied into the forwarded e-mail.

Interaction ID Property

Set to a meaningful value or keep the default value, which is the system variable InteractionId.

Can be used for "interaction-less" processing for scenarios where the InteractionId variable is not automatically initialized, but instead must wait for an event. An example would be an SCXML application triggered by a Web Service that does not add an interaction.

Background: Previous to 8.1.1, Composer did not expose an Interaction ID property. Instead, when ORS started processing an interaction, a generated SCXML application automatically initialized the system variable, InteractionId. This variable was then used internally by Routing and certain eServices blocks when interacting with ORS.

With the introduction of support for Interaction-less processing, you can now define a specific event (**IPD** Event property) to initialize InteractionId, or not define an event at all.

For scenarios with an interaction (IPD Diagram/Event=interaction.present for example), you may keep the default value for the Interaction ID property. The default value is the system variable InteractionId, which is initialized automatically in this case.

For other scenarios (any scenario where the system variable InteractionId is not set), you may choose to:

1. Not use blocks that require an Interaction ID
2. And/or set the Interaction ID property to a meaningful value

3. And/or assign a meaningful value to the InteractionId system variable

Logging Details Property

Logging details contains the expression that will be logged at runtime by the ORS platform. If logging details are specified, then logging is generated for the block; if no logging details are specified, no logging is generated.

To create logging details:

1. Click the **Logging Details** row in the block's property table.
2. Click the ... button to open the **Logging Details** dialog box.
3. In the Logging Details dialog box, click **Add** to open **Expression Builder**.
4. Create an expression to be used for logging details, such as an expression based on the variables whose content you wish to log.

Log Level Property

To assign a value to the Log Level property:

1. Select the **Log Level** row in the block's property table.
2. In the **Value** field, select one of the following from the drop-down list:
 - **Project Default**. The block uses the project's default log level, which can be configured through the project properties.
 - **Info**. This is an Informational level to log application-specific data.
 - **Debug**. Debug level is used for application debugging.
 - **Error**. Error level is used to log error details.
 - **Warn**. Warning level is used to flag any application warnings.
 - **Alarm**. Alarm level is used to send the message as an alarm to the Genesys Management Framework.

Language Property

To set the active language:

1. Select the **Language** row in the block's property table.
2. Click under **Value** to display a down arrow.
3. Select one of the following languages:

- **English (US)**
- **Spanish**
- **Mandarin**
- **Cantonese**
- **Vietnamese**
- **French**
- **French (Canada)**
- **German**
- **Italian**
- **Japanese**
- **Korean**
- **Russian**

Name Property

The Name property is present in all blocks in Composer. The Name property is the first property for all blocks. Use the Value field in the **Name** property row of the block's property table to name the block.

- Block names should conform to ECMAScript and SCXML identifier naming conventions. There is no limit to the maximum number of characters.
- Names may consist only of numbers, letters, or initial underscores (_).
- Names should only begin with a letter or underscore.
- Except for the Entry and Exit blocks, you should give all blocks a descriptive name. For example, if an Input block asks the caller to input an account number, then the name of the block could be Input_Account_Number.
- The name of the block is used as the "Name" of the <form> tag that gets generated for that block.

To provide a name for a block:

1. Select the **Name** row in the block's property table.
2. In the **Value** field, type a block name that conforms to the restrictions above.

Orchestration Extensions Property

Starting with 8.1.4, Composer blocks used to build routing applications (with the exception of the Disconnect and EndParallel blocks) add a new ORS Extensions property. Use this property to add custom attributes into any/all states and sub-states for any block they are configured in. Add the ORS Extensions property to the Properties view for a selected block by clicking the **Show Advanced Properties** button.

Show Advanced Properties

When creating a new diagram in Composer perspective, this button appears on the right side of the Composer GUI, between the palette of blocks and the Properties view.



This property gives the ability to use any attribute **Orchestration Server** supports in addition to the SCXML standard. For information on these attributes, see the attributes prefixed with "_" in the **SCXML Elements** section of the *Orchestration Server Developer's Guide*. For example, you can specify additional attributes to be added into the SCXML <state> element, which Orchestration Server can then use to control **persistence** on a <state> level and for other functionality in the future.

Orchestration Options

Selecting Properties from the Project menu opens a dialog box showing the properties of the selected Project or of the Project that contains the selected resource. Select **Orchestration Options** to view other settings.

Output Queue Property

Select the output queue for the new interaction.

Only **interaction queues** that were created in the current Composer Project are shown for the Configuration Server values. The interaction queues are sorted per parent Interaction Process Diagram. To define the output queue:

1. Click under **Value** to display the ... button and open the Select an Output Queue dialog box.
2. Click the **Type** down arrow and do one of the following
 - If you are connected to Configuration Server, select **Configuration Server** and then select an output queue as the **Value**. The **Independent Objects > Same queue** choice allows you to put the outbound interaction in the same interaction queue that initiated the current interaction.
 - Select **Literal** and then enter the name of the output queue as the Value.
4. Click **OK**.

Output Result Property

Use this property to specify a variable where the new interaction will be saved. The results will then be available in other blocks in the application for further processing.

The format of returned data is JSON. Any post processing work to be done on returned results can be done in the existing **Assign block** which provides access to ECMAScript functions. It already supports writing simple or complex expressions to extract values out of JSON strings and arrays.

Prompts Property

Use the Prompts property to specify the audio prompts that are played to the caller in a Play Message or User Input block. You can specify prerecorded prompts, text, and several standard data types.

To add, delete, or arrange prompts:

1. Click the **Prompts** row in the block's property table.
2. Click the ... button to open the Prompts dialog box.
3. Click **Add** to enable **Prompt Type**, **Interruptible**, and **Value** fields.
4. From the **Type** drop-down list, select a Type: **Announcement**, **RecordedAnnouncement**, **FormattedDigits**, or **Text**. See table below.
5. **Interruptible**—Select **true** or **false**. Indicates whether the caller can interrupt the message. Instructs URS to send a message to T-Server indicating that the announcement is interruptible.
6. **Value***—Enter data for the selected Type.

Place the audio files in the Resources\Prompts\{APP_LANGUAGE} folder under the Java Composer Project. Audio files can be added to the project by copying and pasting from the Windows file system into the Java Voice Project in the Project Explorer.

Note: By default, Genesys supplies .vox files only for mu-law 8Khz. If you are using any other audio format for playback of audio files, replace the files with the corresponding audio files in the required audio format.

Standard Response Property

Use this property to select the text from your eServices Knowledge Management **Standard Response** library. You can enter either a category code or a standard response identifier.

1. Click under **Value** to display the ... button and open the Select a Standard Response dialog box, which organizes standard responses by **categories**. Starting with 8.1.440.18, the dialog box for the eServices blocks that contain a Standard Response property shows a category/standard response tree as defined in **eServices Knowledge Manager**.
2. From the **Type** dropdown menu, do one of the following:

- If you are connected to Configuration Server, select **Configuration Server**. Expand the category. Then select the Standard Response identifier or category code. An example with a category selected is shown below.

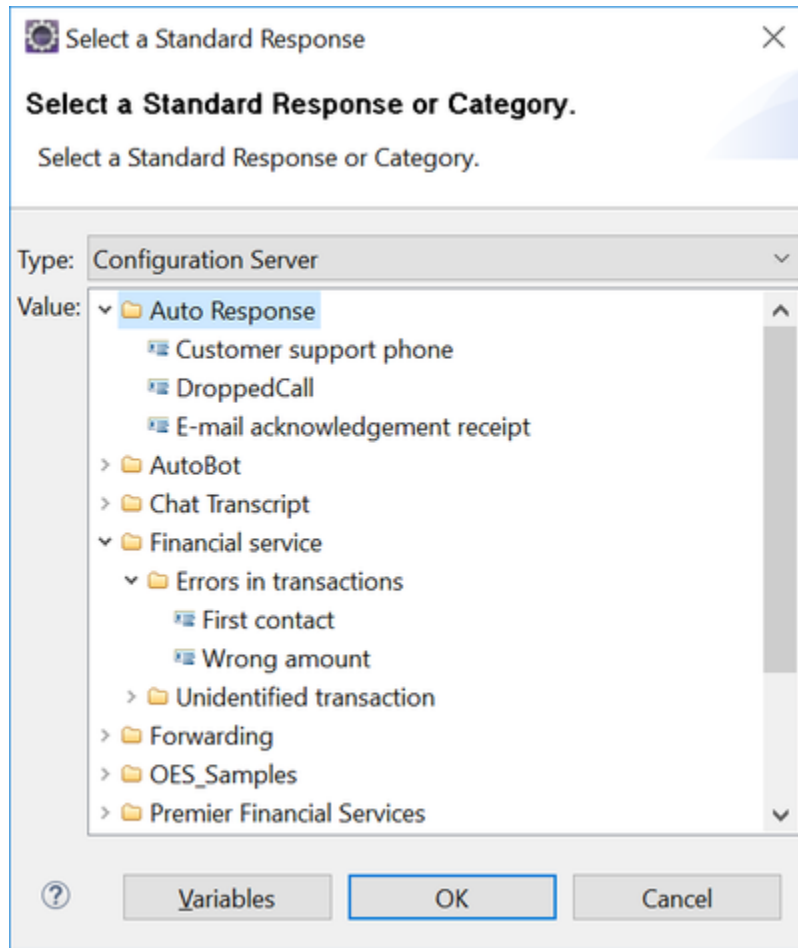

- Standard Response property dialog box also gives the option of using a literal or variable. If you select **Variable**, select a variable containing one of the following:
 - A category code from a variable whose value is set to an existing category code in the form `"gdata:config\\CA.<id>"`, where `<id>` is the category ID. Example: `msgsrc=gdata:config\\CA.00005a5FS3GW005G`
 - A standard response identifier in the form `"gdata:config\\SR.<id>"`, where `<id>` is the standard response identifier. Example: `msgsrc=gdata:config\\SR.00005a5FS3GW005A`
- 4. If you select **Literal**, manually enter the category code or Standard Response identifier.
- 5. Click **OK** to close the dialog box.

Subject Property

This property is enabled if the **Use Subject From SRL** property is set to **false**. Enter the subject to appear in the Subject field of the outbound interaction.

Tenant Property

This mandatory property is set by default to `Variable(TenantID)`, whose value is assigned by Orchestration Server. To override this value, click the button to open the Tenant dialog box where you can select another variable to contain the TenantID or enter the value as a literal.

Note: UCS will fail executing the requested task if passed the `Tenant_Name` instead of the TenantID.

To Property

Use this property to specify the address to which the interaction is to be sent. See the [Getting Using Email Addresses](#) topic for information on getting the e-mail address of a customer using Context Services blocks and using it in the **To** property. Also see the Note below.

1. Click under **Value** to display the ... button and open the Select To E-mail Address dialog box.
2. From the **Type** dropdown menu, you have the following options:
 - If you are [connected to Configuration_Server](#), select **Configuration Server**. Select the to address from the **Value** field in the form of an Configuration Server E-mail Accounts Business Attribute. Select **User Data** as the Type and **EmailAddress** for a value.
 - Select **Literal** and enter the To address in the **Value** field.
 - Select **Originating Email** (only for the Email Response block with Response Type as Auto Response or Acknowledgement and only for the Email forward block with Forward type as Reply to Customer) and then select the **Value** as **From** or **To - all**.
 - Select **Variable** from the dropdown menu and then select the variable that contains the To address.
4. Click **OK** to close the dialog box.

Universal Contact Server Property

Specify the Universal Contact Server to use.

1. Click under **Value** to display the ... button and open the Application Selection dialog box.
 2. The next step depends on whether you are connected to Configuration Server.
 - If you are connected, select **Configuration Server** from the **Type** dropdown menu. Select
-

the name of the Universal Contact Server object from the **Value** field. If not connected:

- Select **Literal** and enter the name of the Universal Contact Server in the **Value** field.
- Or select **Variable** and select the variable from the **Value** field.

Update Interaction User Data Property

Select **true** to have the UCS returned values be attached to the interaction User Data in the form of key-value pairs; otherwise select **false**.

When set to **true**, the following user data key-values are added to this interaction's user data:

- **ContactCreated**: true or false.
- **NumberOfContactsFound**: Number of contacts identified with the given User Data.
- **ContactIdList**: A string or an array of strings with the list of matching contact IDs. Note: if the **Return Unique** property is set to true, **ContactIdList** is not returned if multiple contacts are identified.

Update User Data Property

Select **true** to have the contact attribute values returned by the Universal Contact Server be part of the User Data of the response.

Select **false** to have the contact attribute values returned by the Universal Contact Server be part of the parameters of the response.

Universal Contact Server returns contact attribute values only when a unique contact is found/created. Also note the following:

- If a unique contact is identified or created and this property is false, the contact attribute values will also be returned in the parameter part of the ESP response and will be added in the interaction's User Data as well.
- When this property is set to **true** AND if a unique contact is identified or created, Universal Contact Server returns the contact attribute values in the User Data part of its response. The User Data part of the response is automatically added to the interaction's User Data.
- If this property is set to **false** AND a unique contact is identified/created, the contact attribute values are passed back to the Orchestration platform in the parameter part of the response. In that case, you might choose to add them to the interaction's User Data by setting the Update Interaction User Data property.
- Regardless of the value of the Update User Data property, Universal Contact Server ALWAYS returns the contact ID in the User Data part of its response to Orchestration Server when a unique contact is identified/created.

Uri Property

The Uri property specifies the Location of the Method or File depending on the value of the **Type** property.

To set a URL destination for the Uri property (Type property is set to URL):

1. Select the **Uri** row in the block's property table.
2. In the **Value** field, type a valid URL, or select a **variable** from the drop-down list.

To set a Project destination for the Uri property (Type property is set to **ProjectFile**):

1. Click the **Uri** row in the block's property table.
2. Click the  button to open the Uri dialog box.
3. Select a workflow in the list.
4. Click **OK** to close the dialog box.

Use Subject From SRL Property

Select **true** or **false** to indicate whether to get the e-mail Subject from the Standard Response Library.

Variables Mapping Property

Use this property to map individual contact attribute values to variables.

Note:

- Contact attribute values are returned only when a unique contact is identified.
- Only primary contact attribute values are returned.

To use variables mapping, open the **Variables Mapping** dialog box.

Social Media Blocks

Two new social media blocks are introduced in Composer 8.1.450.04 to handle Twitter and Facebook social media interactions and support easier integration with Conversation Manager. Using the new **Twitter** and **Facebook** blocks, an organization's Twitter and Facebook handles can be monitored through pre-defined events and messages filtered based on keywords to determine the next action.

In addition, users can also connect via the Facebook Messenger. The message is stored in the Contact History to determine further action based on the day and time the message is received.

Configuring Social Media Accounts

For information on configuring social media accounts, see the *eServices Social Media Solutions Guide*, [Setting Up Social Engagement](#).

Twitter and Facebook Use Case

1. The user searches on Twitter or Facebook for the company's handles and tweets or posts a message, which could be related to an issue being faced or a query targeted to customer care.
2. The application monitors the Twitter and Facebook handles through pre-defined events and filter messages based on keywords to determine the next action.
3. The application verifies if the corresponding contact already exists in the Contact History. The user is identified in the Contact History by their Facebook or Twitter handle (if available).
4. If the user does not exist (that is, social handles are not associated with a registered user), the application creates a user in the Universal Contact Database based on available data. Any further messages and agent replies are stored under this user.
5. The application then verifies if the day is a normal operational day. If not, a special day message is sent stating that the user's query will be answered once the service is back online. The special day message is sent as a public message or a private message.
6. The application has the ability to determine if the operating hours of the service match the current time and day - if not, a standard message is sent in response stating that the query will be answered once the service is back online. This message is sent as a public message or a private message.
7. In addition, it is possible to define an emergency message that will be sent either as a public message or a private message, if the emergency process is activated.
8. If within operating hours on a regular day, the application searches for an available agent with the correct skills.
 1. If an agent is available, the interaction is routed to an agent.
 2. If no agent is available, the interaction is queued until an agent becomes available.
3. The interaction is sent to the agent for an appropriate response.

4. The agent decides if the interaction requires private comments.
 1. If no private answer is required, the agent replies via the company's Facebook page or Twitter handle.
 2. If private messaging is required, the interaction is moved out of the public comment space and managed via private messaging (Twitter DM or FB Messenger).

Tip

Best practice for the agent is to respond to a public message with a public response, indicating that the conversation might be moved to private messaging, if required at a later stage.

3. The agent also has the ability to simply **retweet** or **like** the user comment, or **create favorite**, if it is considered as general positive feedback and no specific answer or further action is required.
4. When the interaction is completed, the agent sets a disposition code to register the outcome for reporting purposes.
5. In addition, the following strategies can also be implemented:
 1. When a tweet or Facebook post mentioning the organization is posted, an automatic reply to the tweet or Facebook post is triggered. If there is an error in posting the reply, the routing application retries posting the reply for a predefined duration.
 2. When a direct message is sent to the organization's Twitter handle, the interaction is routed to a specific agent group.
 3. When a positive tweet or Facebook post about the organization is posted, the routing application automatically retweets or likes the message.

Facebook Messenger Use Case

1. The user sends a message via the Facebook Messenger, to the company (for example, after having been asked by an agent to connect privately).
2. The message is stored with the customer contact in Contact History.
3. The application then verifies if the day is a normal operational day. If not, a special day message is sent stating that the user's query will be answered once the service is back online. The special day message is sent via Facebook Messenger.
4. The application has the ability to determine if the operating hours of the service match the current time and day - if not, a standard message is sent in response stating that the query will be answered once the service is back online. This message is sent via Facebook Messenger.
5. In addition, it is possible to define an emergency message that will be sent via Facebook Messenger, if the emergency process is activated.
6. If within operating hours on a regular day, the application searches for an available agent with the correct skills.
 1. If an agent is available, the interaction is routed to an agent.

2. If no agent is available, the interaction is queued until an agent becomes available.
3. The interaction is sent to the agent for an appropriate response.
4. A Facebook chat session is established between the user and the agent.
5. When the interaction is completed, the agent sets a disposition code to register the outcome for reporting purposes.

Sample Business Processes

For sample business processes, see the *eServices Social Media Solutions Guide*, [Sample Business Processes for Social Media](#).

Twitter Block

Use the Twitter block to handle incoming Twitter interactions. Twitter handles can be monitored through pre-defined events and messages filtered based on keywords to determine the next action.

The Twitter block has the following properties:

Name Property

Find this property's details under [Common Properties](#).

Block Notes Property

Find this property's details under [Common Properties](#).

Exceptions Property

Find this property's details under [Common Properties](#).

Condition Property

Find this property's details under [Common Properties](#).

Logging Details Property

Find this property's details under [Common Properties](#).

Log Level Property

Find this property's details under [Common Properties](#).

Result Property

Click the down arrow under **Value** and select the variable to hold the raw data returned by the Social Messaging Server.

Application Property

Specify the Application Name of the Social Messaging Server.

1. Click under **Value** to display the ... button.
2. Click the ... button to open the Application Selection dialog box.
3. Click the down arrow opposite **Type** and select **Literal**, **Variable**, or **Configuration Server**.
4. If you selected *Configuration Server*, select the Social Messaging Server application from the drop-down of the **Value** field and click **OK**.
5. If you selected **Literal** or **Variable**, enter the literal or select a variable, and click **OK**.

Method Name Property

Select the method to be invoked. This is a mandatory field and the value can be a variable, literal, or method name enum (SendMessage, DestroyMessage, GetUserInfo, RetweetTweet, FollowUser, UnfollowUser, GetFriends, GetFollowState, CreateFavorite, DestroyFavorite, GetMediaContent).

[+] The input and output parameters for the different methods are listed here (mandatory parameters are in bold font).

Method Name	Description	Input Paramaters	Output Paramaters
MergeltxData	<p>This ESP request is used to combine the attached data of two Twitter interactions related to the same post, update attached data of specified interaction, and return the final attached data subset that was added to the specified Twitter interaction.</p> <p>The necessity in such request appears when the routing business process detects that there is more than one interaction related to the same post (for example, a new comment(s) was added while the interaction was sitting in a Genesys interaction queue). In this</p>	<p>_umsChannel, _twitterMergeltxDId</p>	<p>_twitterMergedUserData</p>

Method Name	Description	Input Paramaters	Output Paramaters
	case, instead of delivering two interactions to an agent, the routing business process will try to merge them and deliver updated data to an agent.		
SendMessage	Request to send a Twitter message.	_umsChannel, _twitterMsgType, _twitterMsgPlainText, _twitterInReplyToStatusId, _twitterToAddr, _twitterPictureName, _twitterPictureBody	_twitterMsgId
DestroyMessage	Request to destroy own status or direct message.	_umsChannel, _twitterMsgType, _twitterMsgId	_twitterMsgId, _twitterMsgPlainText
GetUserInfo	Request to get information about a Twitter user.	_umsChannel, _twitterUserId	'_twitterUserName, _twitterUserScreenName, _twitterUserDescr, _twitterUserCreatedAt, _twitterUserImageUrl, _twitterUserLocation, _twitterUserTimeZone, _twitterUserFollowersCount, _twitterUserFriendsCount, _twitterUserStatusesCount, _twitterUserIsFollower, _twitterUserIsFollowee, _twitterPlaceFullName, _twitterIsFavorited, FirstName, LastName
RetweetTweet	Request to retweet a Twitter message.	_umsChannel, _twitterMsgId	_twitterMsgId, _twitterMsgPlainText
FollowUser	Request to follow another Twitter user.	_umsChannel, _twitterUserId	_twitterUserName, _twitterUserScreenName, _twitterUserDescr, _twitterUserCreatedAt, _twitterUserImageUrl, _twitterUserLocation, _twitterUserTimeZone, _twitterUserFollowersCount, _twitterUserFriendsCount, _twitterUserStatusesCount, _twitterUserIsFollower, _twitterUserIsFollowee, _twitterPlaceFullName, _twitterIsFavorited, FirstName, LastName
UnfollowUser	Request to unfollow another Twitter user.	_umsChannel, _twitterUserId	_twitterUserName, _twitterUserScreenName, _twitterUserDescr, _twitterUserCreatedAt,

Method Name	Description	Input Paramaters	Output Paramaters
			_twitterUserImageUrl, _twitterUserLocation, _twitterUserTimeZone, _twitterUserFollowersCount, _twitterUserFriendsCount, _twitterUserStatusesCount, _twitterUserIsFollower, _twitterUserIsFollowee, _twitterPlaceFullName, _twitterIsFavorited, FirstName, LastName
GetFriends	Request to get a list of friends of a Twitter user.	_umsChannel, _twitterUserId	_twitterUserIdList
GetFollowState	Request to get "a friend" and "a follower" states of a user.	_umsChannel, _twitterUserId	_twitterUserIsFriend, _twitterUserIsFollower
CreateFavorite	Request to set a Twitter (status) message as favorite.	_umsChannel, _twitterMsgId	_twitterMsgId, _twitterMsgPlainText
DestroyFavorite	Request to destroy a Twitter (status) message as favorite.	_umsChannel, _twitterMsgId	_twitterMsgId, _twitterMsgPlainText
GetMediaContent	Request to get content of a media attached to a direct Twitter message.	_twitterMediaContentUrl	_twitterMediaContentBin

Method Parameters Property

List of input parameters populated automatically based on the selected method in the **Method Name** property. The automatically populated values can be edited, if required. You can also add the new parameters by clicking the **ADD** button. The Method Parameters (key and value) can be specified either as a literal or variable.

Composer supports special keys such as, TWITTER_CHANNEL (equivalent to `_genesys.ixn.interactions[system.InteractionID].udata['_umsChannel']` in the code sample), which can be used to map values for the parameters.

Tip

Refer to the table in the **Method Name Property** section above for more information on custom parameters.

Service Timeout Property

Specify the timeout in seconds to invoke the ESP service on a timeout error. The default value is 10 seconds. You can specify the timeout value either as a literal or variable, but it must be a positive integer.

Enable Status Property

Find this property's details under [Common Properties](#).

[+] Twitter Block Code Sample

```
<state id="RetweetMessage">
  <onentry>
    <log expr="_sessionid + ': Inside Twitter Block: RetweetMessage'" />
    <script><![CDATA[
      App_RetweetMessage.content = {};
      App_RetweetMessage.content.params = {
        _umsChannel:
      _genesys.ixn.interactions[system.InteractionID].udata['_umsChannel'],
        _twitterMsgId:
      _genesys.ixn.interactions[system.InteractionID].udata['_twitterMsgId']
    };
    ]]></script>
    <session:fetch requestid="App_RetweetMessage['requestid']"
      srcexpr="'SocialMessagingServer' + '\\CFGSocialMS\\Twitter\\' +
'RetweetTweet'" attach_ixn_data="true" timeout="10" method="'esp'">
      <content _expr="App_RetweetMessage.content" />
    </session:fetch>
  </onentry>
  <transition event="session.fetch.done"
cond="_event.data.requestid==App_RetweetMessage['requestid']" target="$_MY_PREFIX_$.Exit1">
    <log expr="'Composer Application:default Block: RetweetMessage'" />
    <log expr="'Session FETCH DONE'" />
    <log expr="'Data Fetched:' + _event.data.content" />
    <script>storeEvent("RetweetMessage", _event);</script>
    <script>App_RetweetMessage['data'] = eval('(' + _event.data.content +
  ')');</script>
  </transition>
</state>
```

Facebook Block

Use the Facebook block to handle incoming Facebook interactions. Facebook handles can be monitored through pre-defined events and messages filtered based on keywords to determine the next action.

The Facebook block has the following properties:

Name Property

Find this property's details under [Common Properties](#).

Block Notes Property

Find this property's details under [Common Properties](#).

Exceptions Property

Find this property's details under [Common Properties](#).

Condition Property

Find this property's details under [Common Properties](#).

Logging Details Property

Find this property's details under [Common Properties](#).

Log Level Property

Find this property's details under [Common Properties](#).

Result Property

Click the down arrow under **Value** and select the variable to hold the raw data (JSON structure) returned by the Social Messaging Server.

Application Property

Specify the Application Name of the Social Messaging Server.

1. Click under **Value** to display the ... button.
2. Click the ... button to open the Application Selection dialog box.
3. Click the down arrow opposite **Type** and select **Literal**, **Variable**, or **Configuration Server**.
4. If you selected *Configuration Server*, select the Social Messaging Server application from the drop-down of the **Value** field and click **OK**.
5. If you selected **Literal** or **Variable**, enter the literal or select a variable, and click **OK**.

Method Name Property

Select the method to be invoked. This is a mandatory field and the value can be a variable, literal, or method name enum (SubmitComment, DeleteObject, SubmitPost, SubmitPrivateMessage, SubmitPrivateMessageFromLiveChatSession, ShareObject, ChangeObjectVisibility, LikePublication, EditPublication).

[+] The input and output parameters for the different methods are listed here (mandatory parameters are in bold font).

Method Name	Description	Input Paramaters	Output Paramaters
MergeltxData	<p>This ESP request is used to combine the attached data of two Facebook interactions related to the same post, update attached data of the specified interaction and return the final attached data subset that was added to the specified Facebook interaction.</p> <p>The necessity in such request appears when the routing business process detects that there is more than one interaction related to the same post (for example, a new comment(s) was added while the interaction was sitting in a Genesys</p>	<p>_umsChannel, _facebookMergeltxid</p>	<p>_facebookMergedUserData</p>

Method Name	Description	Input Parameters	Output Parameters
	interaction queue). In this case, instead of delivering two interactions to an agent, the routing business process will try to merge them and deliver updated data to an agent.		
GetComments	This ESP request is used to get Facebook comments for particular post, for a specified time period.	_umsChannel, _umsChannelMonitor, _facebookPostId, _facebookStartTime, _facebookEndTime, _facebookLimit, _facebookOffset, _facebookOrder, UserData (any key)	_facebookXML
SubmitComment	This ESP request is used to publish Facebook comments for a particular post or a reply on a particular comment. The parameter <i>_facebookObjectId</i> is mandatory, and its value is either a post ID or a comment ID. If the parameter value is a comment id, then a reply to a comment will be published to Facebook, otherwise a comment to a post will be published to Facebook.	_umsChannel, _umsChannelMonitor, _facebookPostId, _facebookMessageText, UserData (any key)	_facebookCommentId, _facebookTargetObjectId
DeleteObject	This ESP request is used to delete a Facebook object. This object could be a post, comment, or reply.	_umsChannel, _umsChannelMonitor, _facebookObjectId, UserData (any key)	_facebookObjectId
SubmitPost	This ESP request is used to publish a (new) Facebook post.	_umsChannel, _umsChannelMonitor, _facebookSourceId, _facebookMessageText, _facebookPictureBody, _facebookPictureName, _facebookLink, _facebookDescription, _facebookTimelineVisibility, UserData (any key) Tip An empty post could be published if the <i>_facebookPictureBody</i> or <i>_facebookLink</i> parameters are supplied. Otherwise the <i>_facebookMessageText</i> parameter is mandatory.	_facebookPostId

Method Name	Description	Input Parameters	Output Parameters
SubmitPrivateMessage	This ESP request is used for submitting Facebook unsolicited outbound private messages.	_umsChannel, _umsChannelMonitor, _facebookPMThreadId, _facebookMessageText, UserData (any key)	_facebookPMMessageld
SubmitPrivateMessageFromLiveChatSession	This ESP request is invoked by Social Messaging Server, only for live Facebook ChatSession and should not be used by other clients. As result, the Facebook driver loaded within Social Messaging Server creates a Facebook private message in the specified chat thread.	_umsMsgPlainText, _umsChannelMonitor, _umsAttachedData Important The <i>_umsAttachedData</i> parameter has the following additional parameters: <i>_umsChannelMonitor,</i> <i>_facebookPMThreadId,</i> <i>_facebookLink,</i> <i>_facebookDescription.</i>	_facebookPMMessageld
ShareObject	This ESP request is used to share a Facebook post, photo, link to a web page or an HTTP link to publicly available file.	_umsChannel, _umsChannelMonitor, _facebookObjectId, _facebookMessageText, _facebookDescription	_facebookPostId
ChangeObjectVisibility	This ESP request is used to change Facebook post visibility. However, note that Facebook doesn't allow to hide Comments/Replies through the Facebook API.	_umsChannel, _umsChannelMonitor, _facebookObjectId, _facebookObjectType, _facebookVisibility	_facebookObjectId
LikePublication	This ESP request is used to like and unlike a Facebook post, comment or reply. The object will be liked/unliked on behalf of the publish access token owner specified in the configured monitor specified in the ESP request input parameter <i>_umsChannelMonitor</i> .	_umsChannel, _umsChannelMonitor, _facebookObjectId, _facebookLikeObject	_facebookObjectId
EditPublication	This ESP request is used to edit an existing Facebook post, comment, or reply.	_umsChannel, _umsChannelMonitor, _facebookObjectId, _facebookMessageText	_facebookObjectId

Method Parameters Property

List of input parameters populated automatically based on the selected method in the **Method**

Name property. The automatically populated values can be edited, if required. You can also add the new parameters by clicking the **ADD** button. The Method Parameters (key and value) can be specified either as a literal or variable.

Composer supports special keys such as, FACEBOOK_CHANNEL (equivalent to `_genesys.ixn.interactions[system.InteractionID].udata['_umsChannel']` in the code sample), which can be used to map values for the parameters.

Tip

Refer to the table in the **Method Name Property** section above for more information on custom parameters.

Service Timeout Property

Specify the timeout in seconds to invoke the ESP service on a timeout error. The default value is 10 seconds. You can specify the timeout value either as a literal or variable, but it must be a positive integer.

Enable Status Property

Find this property's details under [Common Properties](#).

[+] Facebook Block Code Sample

```
<state id="Facebook1">
  <onentry>
    <log expr="_sessionid + ': Inside Facebook Block: Facebook1'" />
    <script><![CDATA[
      App_Facebook1.content = {};
      App_Facebook1.content.params = {
        _umsChannel:
_genesys.ixn.interactions[system.InteractionID].udata['_umsChannel'],
        _umsChannelMonitor:
_genesys.ixn.interactions[system.InteractionID].udata['_umsChannelMonitor'],
        _facebookPostId:
_genesys.ixn.interactions[system.InteractionID].udata['_facebookPostId'],
        _facebookMessageText: 'Thanks'
      };
    ]]></script>
    <session:fetch requestid="App_Facebook1['requestid']"
srcexpr="'SocialMessagingServer_854' + '\\CFGSocialMS\\Facebook\\' + 'SubmitComment'"
attach_ixn_data="true" timeout="30" method="'esp'">
      <content _expr="App_Facebook1.content" />
    </session:fetch>
  </onentry>
  <transition event="session.fetch.done">
```

```
cond="_event.data.requestid==App_Facebook1['requestid']" target="$$_MY_PREFIX_$.Exit1">
  <log expr="'Composer Application:default Block: Facebook1'" />
  <log expr="'Session FETCH DONE'" />
  <log expr="'Data Fetched:' + _event.data.content" />
  <script>storeEvent("Facebook1", _event);</script>
  <script>App_Facebook1['data'] = eval('(' + _event.data.content + ')');</script>
</transition>
</state>
```

Other Workflow Functionality

- [CommonPropertiesforWorkflowBlocks](#)
- [Variables Project and Workflow](#)
- [User Data](#)
- [CustomEvents](#)
- [Building Expressions](#)
- [SkillExpressionBuilder](#)
- [List Objects Manager](#)
- [Statistics Manager and Builder](#)
- [ORS Extensions](#)
- [ServiceLevelRouting](#)
- [Exception Events](#)
- [Universal Routing Server Functions](#)

Variables Project and Workflow

This page discusses Project, Workflow, and internal variables.

Types of Variables

As can be seen in the **Application Variables dialog box**, Composer uses the following types of variables:

- **System**—Pre-defined system variables hold Project and application-related values. You cannot delete system variables, but applications can modify their values.
- **User**—User-defined custom variables that you create by clicking the **Add** button in the **Application Variables** dialog box shown below and selecting User. Applications can delete and modify these types of variables.
- **Project Variables** in the **Project Variables** dialog box, which opens when you click the **Access Project Variables** button on the toolbar with the IPD in focus. Use Project variables when you need to share information across different workflows. Once defined, Project variables are accessible for use in expressions in Expression Builder.

For example, the **Assign block** allows you to assign entered values or values created in **ExpressionBuilder** to variables. Once defined, those variables are accessible for use in expressions in Expression Builder.

Block Properties as Variables

Many block properties can be specified as workflow variable. To name just a few:

- Target Block properties: Statistic, Timeout, Target Name (if type = Variable), Target Component Selected, Target Object Selected, Target Selected, Virtual Queue Selected, Virtual Queue
- Play Application properties: Resource
- Play Sound Block properties: Resource, Duration
- Play Message Block properties: Prompts > Values field in Prompts dialog box
- User Input Block properties: Prompts > Values field in Prompts dialog box. AbortDigits, BackspaceDigits, Collected Digits Variable, IgnoreDigits, Number of Digits, Termination Digits, ResetDigits, Resource, StartTimeout, DigitTimeout, TotalTimeout, Verification Attempts, Verification Data
- Set Default Route Block: Destination property
- Route Interaction Block: Statistics property
- Subroutine Block: Parameters property
- Stop Interaction Block Reason to Stop Interaction Property

- Context Services: All blocks have certain properties that allow you to select a variable.
- eService: All blocks have certain properties that allow you to select a variable.

Upgrading from Composer 8.0.2 or earlier

Prior to 8.0.3 release, Composer defined workflow variables in the data model of the SCXML application so they were required to be accessed by prefixing the name of a workflow variable with "_data.". For example, if you defined a workflow variable named var1, you would access it as _data.var1. Starting with 8.0.3, Composer defined these variables in the ECMAScript scope so the variable is accessed simply as var1.

Application Variables Dialog Box

Note: When using the **ORS Debugger**, are not displayed correctly in the **variables view toolbar** if the value contains XML or variables that are of type E4X.

To define/view variables:

1. In the Properties tab, click opposite **Variables** under Value to display the  button.
2. Select **Project**, **System**, or **User Variables**.
3. Click the arrow to display the selected type. An example dialog box is shown below.

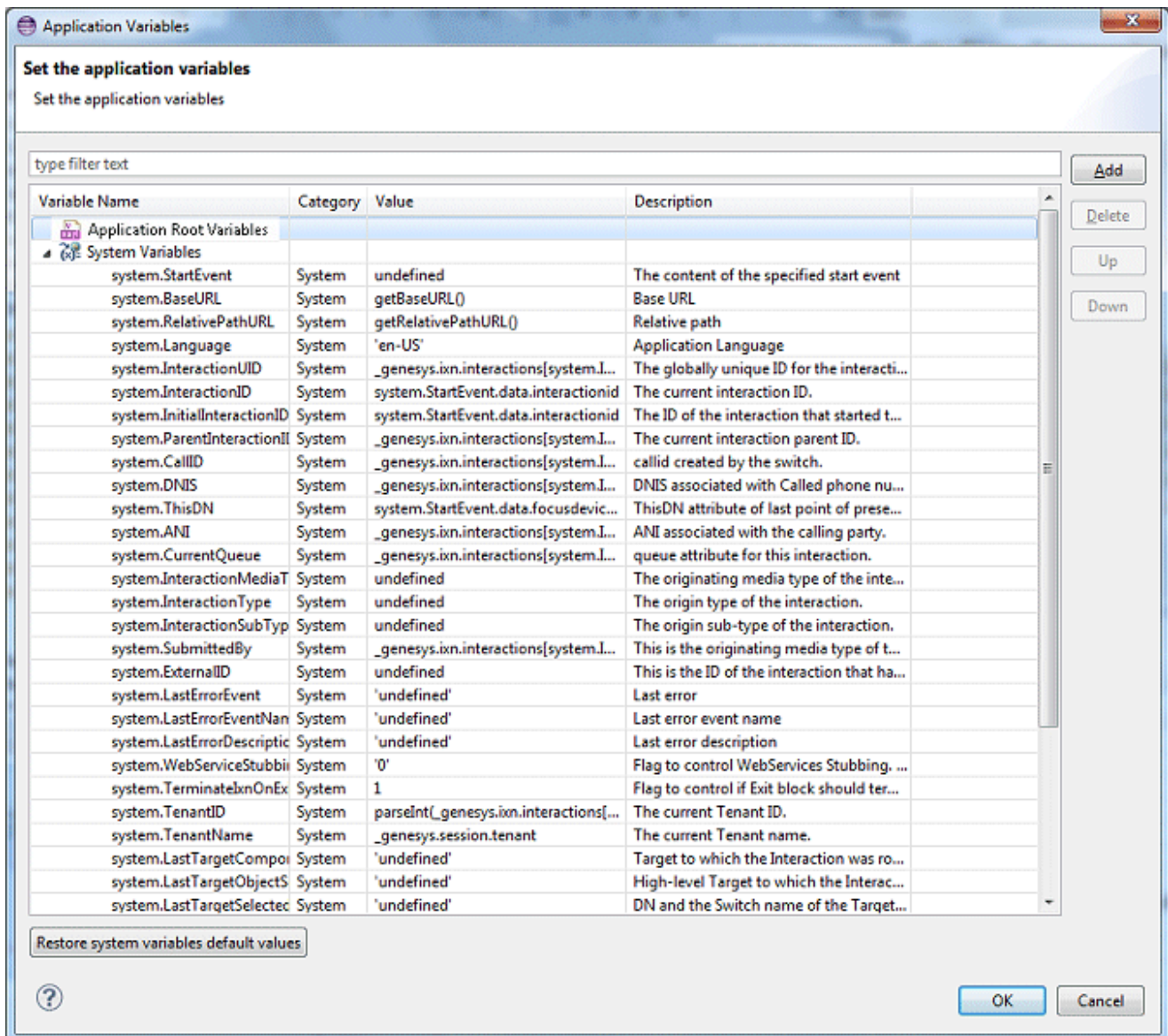

To add a new variable:

1. Click **Add**. Composer add a row for variable and generates a temporary name and number; for example: var7.
2. Select the row and supply the **Name**, **Type**, **Value**, and **Description** fields.
3. Click **OK**.

System Variables

- **system.Language**—Holds the application language setting. The value should be the RFC 3066

language tag of an installed language pack. Examples of valid RFC 3066 language tags include en-US and fr-FR. This setting also acts as a default language for the application.

- **system.CallID**—Call identifier created by the switch. It is initialized from `_genesys.ixn.interactions[system.InteractionID].voice.callid` (voice only).
- **system.DNIS**—Number that the caller dialed. It is initialized from `_genesys.ixn.interactions[system.InteractionID].voice.dnis` (voice only).
- **system.ANI**—Caller's phone number. It is initialized from `_genesys.ixn.interactions[system.InteractionID].voice.ani` (voice only).
- **system.LastErrorEvent**—Stores the last error that was handled in a block.
- **system.LastErrorEventName**—Stores the name of the error that was handled in a block.
- **system.LastErrorDescription**—Stores the description of the last error that was handled in a block.
- **system.WebServiceStubbing**— Flag to control [Web Services Stubbing](#) (1 = ON).
- **system.TerminateIxnOnExit**—Used to automatically stop an interaction that was not stopped by the [Route Interaction](#), [Queue Interaction](#), or [Stop Interaction](#) block in a multimedia workflow. New workflow entry blocks have this variable pre-populated with 1.
- **system.TenantID**—The current Tenant identifier. It is initialized from `_genesys.session.tenantid` or from `_genesys.ixn.interactions[system.InteractionID].tenantid` (if available). See the Update Contact, Identify Contact, Create Interaction, or Render Message block for more information.
- **system.TenantName**—The current Tenant name. It is initialized from `_genesys.session.tenant`.
- **system.LastTargetComponentSelected**—Target to which the interaction was routed definitively. See the Target Component Selected property of the Target block.
- **system.LastTargetObjectSelected**—High-level target to which the interaction was routed definitively. See the Target Object Selected property of the Target block.
- **system.LastTargetSelected**—DN and Switch name to which the interaction was routed definitively. See the Target Selected property of the Target block.
- **system.LastVirtualQueueSelected**—The Alias of the Virtual Queue specified in the target list where the interaction was routed. See the Virtual Queue Selected property of the Target block.
- **system.LastSubmitRequestId**—RequestId value of the last `<queue:submit>` execution. This variable is automatically updated when a successful (`queue.submit.done`) or unsuccessful (`error.queue.submit`) event is received. `<queue:submit>` is generated when using Target or RouteInteraction blocks. `<queue:submit>` may also be used if using SCXMLState or BeginParallel blocks.

Operational Parameter Management (OPM): These parameters are defined and provisioned in Genesys Administrator Extension (GAX)

- **system.OPM**—Used by the [OPM Block](#) (**App_OPM** is used in callflow diagrams).
- **system.ThisDN**— Initially set to the same value as `system.DNIS`. The value is updated by the interaction party state changed event handler (see IPD/Events property below) to the value of `focusdeviceid`. This variable becomes the default value for properties: ForceRoute/From, SingleStepTransfer/From, Target/From.
- **system.ParentInteractionID**— In case of Transfer scenario, this variable is assigned the ID of the parent interaction of the current interaction being processed.
- **system.OriginatingSession**— In case of context passing (see 'Pass Context' property description

above), this variable holds the context of the originating session.

Outbound Contact Server (OCS) variables used by [http://internalwiki.us.int.genesyslab.com/Outbound%20Common%20Blocks Outbound blocks]:

- **system.OCS_RecordURI**— Its default value is set when the application starts executing from data passed into the application by the GVP or Orchestration platform. For workflows (SCXML), it is initialized from the userdata key "GSW_RECORD_URI". For callflows (VXML), session.com.genesyslab.userdata.GSW_RECORD_URI is used. This variable points to the 'current' record as determined by OCS and is provided to the application as a convenient way to communicate actions back to OCS for the current record.
- **system.OCS_URI**— Holds the OCS resource path in the format "http(s)://<ocs host>:<ocs port>". Its default value is deduced from OCS_Record_URI. The application can change this variable's value to use a different OCS application for all Outbound blocks in the workflow. Any downstream blocks will use the new value.
- **system.OCS_Record**— Holds the Record Handle deduced from the value of OCS_Record_URI.

Upgrading from Composer 8.1.1 or earlier

The system variables have been renamed in Composer 8.1.2 to improve the usability and to support new features. When upgrading a workflow that was initially developed with Composer 8.1.1 or earlier, the old set of system variables is kept, in addition to the new one, to ensure compatibility as some of those variables might be used in the application (for block properties or even in ECMAScript code). However, users are now encouraged to use the variables that are "system." prefixed.

Composer 8.1.1	Composer 8.1.2
ANI	system.ANI
App_Language	system.language
App_Last_Error_Description	system.LastErrorDescription
App_Last_Error_Event	system.LastErrorEvent
App_Last_Error_Event_Name	system.LastErrorEventName
App_Last_Submit_Request_Id	system.LastSubmitRequestId
App_Last_Target_Component_Selected	system.LastTargetComponentSelected
App_Last_Target_Object_Selected	system.LastTargetObjectSelected
App_Last_Target_Selected	system.LastTargetSelected
App_Last_VirtualQ_Selected	system.LastVirtualQueueSelected
App_RelativePathURL	system.RelativePathURL
App_StartEvent	system.StartEvent
App_Terminate_Ixn_On_Exit	system.TerminateIxnOnExit
CallID	system.CallID
COMPOSER_WSSTUBBING	system.WebServiceStubbing
DNIS	system.DNIS

Composer 8.1.1	Composer 8.1.2
InteractionID	system.InteractionID
Tenant_Name	system.TenantName
TenantID	system.TenantID

Project Variables

Project variables encompass all the workflows in a Project. These types of variables are defined in the data model of the [interaction process diagram](#) (IPD) SCXML application and so are required to be accessed by prefixing the name of a project variable with "_data.". For example, if you define a project variable named var1, you would access it as _data.var1. Project variables are also accessible in [ExpressionBuilder](#). Select Project Variables and then Variables under the [Data Subcategory](#).

Use Project variables when information needs to be shared across workflows in an IPD. For example, if you want to get the e-mail address in one workflow and would like to create and send out an email in another workflow present in the same project. Genesys suggests defining at least one appropriately named Project variable like varProjectXYZ. Any properties that accept a variable will show this variable prefixed with _data in their list.

To define a project variable in [Composer Design](#) perspective:

1. Click the default.ixprocess tab (or the tab for a renamed IPD) to bring it into focus (tab is highlighted).
2. Click the **Access Project Variables** toolbar button. This opens the Project Variables dialog box. An example dialog box with one entry is shown below.

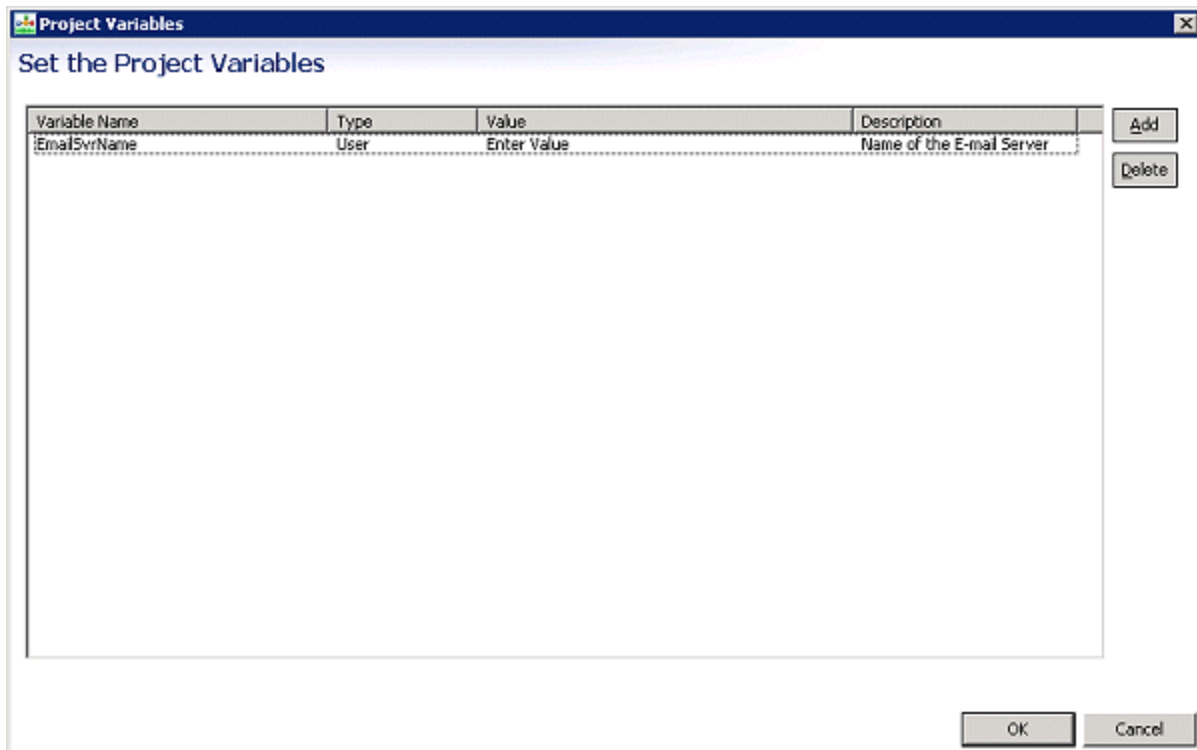

1. Click **Add**. The variable **Name**, **Type**, **Value**, and **Description** fields become editable.
2. Name the variable.
3. Specify an initial value if appropriate.
4. Describe the variable.
5. Click **OK**.

Internal Variables Naming

Starting with 8.1.1, Composer changes its naming policy for internal variables, which are variables that do not appear in any Variable edition dialog. They can be seen only in the generated SCXML code. Composer uses those variables to temporarily store data during an application execution.

Most Composer users will not be affected by this change. However, it is possible that some advanced users may have written applications that use those variables although they were not available "out-of-the-box." In such cases, those users will need to upgrade their application to use the variables with the new names.

Example

In 8.1.0, for a DB Data block named DBDataBlock Composer could declare in the SCXML application the variables:

App_DbDataBlock, App_DbDataBlockDBResult, App_DbDataBlockDBResultColumnNames, App_DbDataBlock_cursor, App_DbDataBlock_mapping

In 8.1.1, for a DbData block named DbDataBlock Composer could declare in the SCXML application only one variable named App_DbDataBlock.

Various properties of this variable will be used, such as App_DbDataBlock['requestid'], App_DbDataBlock['data'], App_DbDataBlock['DBResult'], App_DbDataBlock['DBResultColumnNames'], App_DbDataBlock['cursor'], App_DbDataBlock['mapping']

Attaching Results to User Data

While you can assign Classify object results to a variable, Genesys does not recommend this. The recommended way of dealing with the classification results is to attach them to the interaction. Then User Data will have the keys listed in the table below with the corresponding values returned by Classification Server. As an example, User Data would have the following pairs after the attachment:

Parameter	Value
CtgId	00001a05F5U900QW
CtgRelevancy	95
CtgName	Cooking
CtgId_00001a05F5U900QW	95
CtgId_00001a05F5U900QX	85
CtgId_00001a05F5U900QY	75
CtgId_00001a05F5U900QZ	65

User Data

To work with User Data in Composer, you can use:

- The **Interaction Data block** for voice applications.
- The **User Data** property of the External Service block if you wish to pass User Data to an external service (routing and voice).
- The Entry block to access User Data (routing and voice).

For routing applications, you can use:

- The **User Data block**.
- The **CreateEmail block**, which lets you pick up standard response text from User Data.
- The **CreateSMS block**, which lets you pick up message text from User Data.
- The **Identify Customer block**, which provides an option to update the interaction's User Data with the parameters returned by Universal Contact Server (Contact attribute data).
- The **Create Interaction block**, which lets you create a new interaction record in UCS database based on User Data.
- The **ECMAScript block**. The Script property lets you use Universal Routing Server User Data functions. Open **Expression Builder**. Select URS Functions and then `_genesys.ixn.deleteuData` (to add a User Data property or delete all properties) or `_genesys.ixn.setuData` (to add new or update existing User Data).

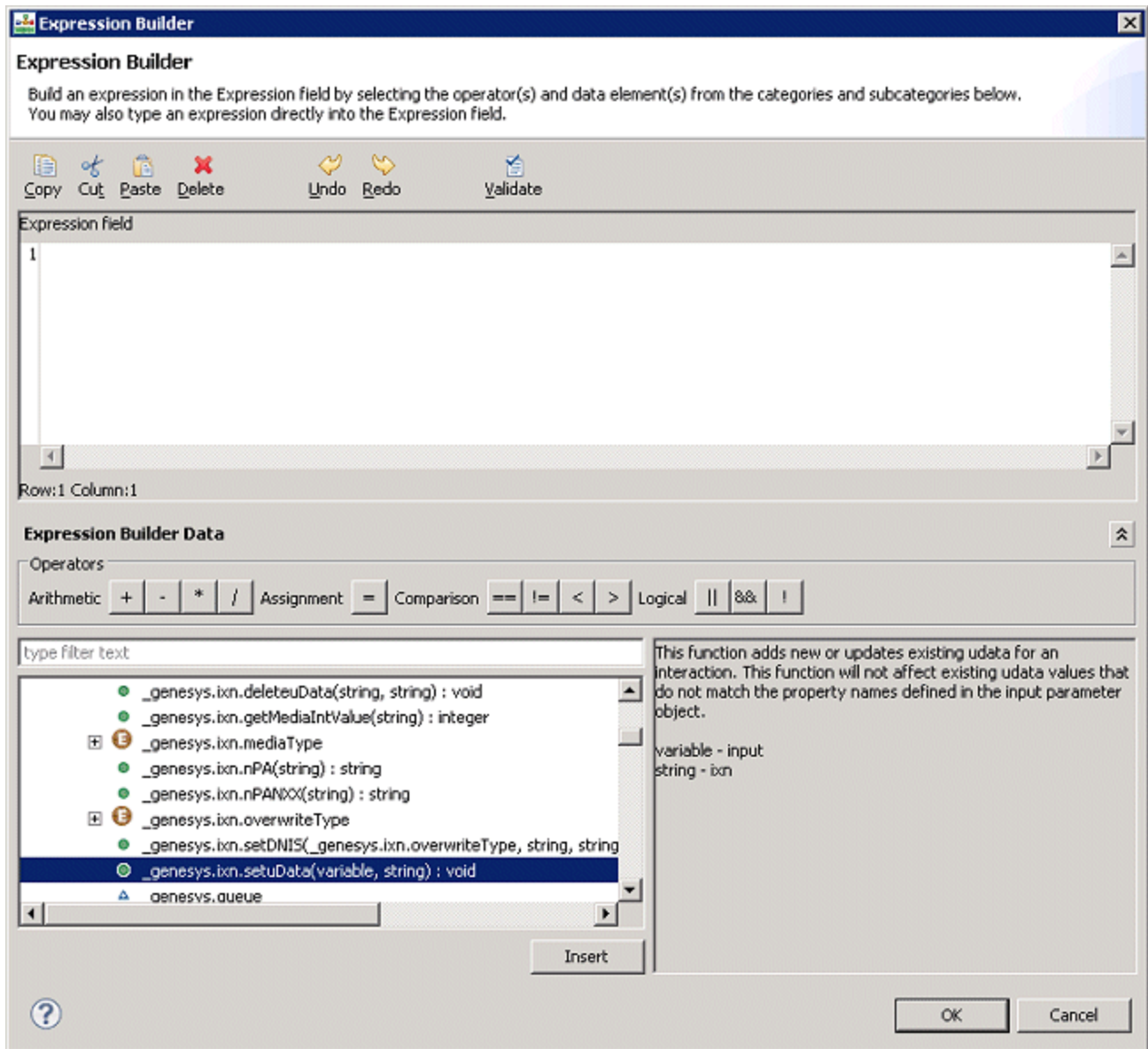

Hints

- A specific variable 'xyz' can be accessed directly; for example: `_genesys.ixn.interactions[0].udata.xyz`
- To write to User Data, use the `setuData()` function in an ECMAScript snippet. Usage is similar to the example below.

```
var input = new Object();
```

```
input.xyz = InputValue1; // Specify a value for the key 'xyz'.
```

```
input['my-key-name'] = 'value'; // Use this notation if the key or property name has a hyphen in it. Note that 'my-key-name' has hyphens.
```

```
_genesys.ixn.setuData(input);
```

- Reading User Data is easier using the Assign block than with the ECMAScript block.

Mandatory Data for UCS Blocks

When working with the Update Contact and Render Message blocks (which map to Universal Contact Server services), certain properties must exist in the interaction User Data.

For the Update Contact block, ContactId must exist.

For the Render Message block, ContactId (if some contact-related Field Codes (as described in the *eServices 8.1 User's Guide*) are used in the text to render). Also InteractionId (if some interaction-related Field Codes are used in the text to render) and OwnerEmployeeId (if some agent-related Field Codes are used in the text to render).

As is the case with IRD, these properties are not set in the blocks themselves. Instead, the properties are assumed to be put in the interaction's User Data by some other block earlier in the workflow, such as the Identify Customer block or Create Interaction block with the Update User Data property set to true. In case no other block does this, the User Data block may be used for this purpose.

If these properties are not available, an explicit UCS error message (missing parameter) shows in the Orchestration Server log.

Retrieving multiple KV Pairs in a user data object

To retrieve multiple KV pairs in a user data object:

- Set the multivalued-prop-in-udata configuration option to true in Orchestration server.

The values can be accessed from Composer using:

- `_genesys.ixn.interactions[_data.system.context.InteractionID].udata.<KeyName>._genesys_Multivalue` (for retrieving all values).
- `_genesys.ixn.interactions[_data.system.context.InteractionID].udata.<KeyName>._genesys_Multivalue[i]` (for retrieving a specific value at an index i).

Callflow User Data

Also see [Route Request block](#) and [Interaction Data](#).

Custom Events

The **Exceptions** dialog box, which opens from the Exceptions property, contains an **Event** button where you can define a custom event in addition to selecting a predefined event. Use this dialog box to define which exceptions or events to handle.

1. In the block, click opposite **Exceptions** under **Value**.
2. Click the ... button to bring up the Exceptions dialog box.
3. In the Exceptions dialog box, click **Event**.
4. In the resulting dialog box, name the event and click **OK**. The event name appears in the **Name** column.
5. When through in the dialog box, click **OK**.
6. Once a custom event is added to the list of exceptions in a block, you will see an exception port for this event (or exception) on the block, which you can now connect to another block to handle that special condition.



Skill Expression Builder

You can route interactions to the most appropriately **skilled** agent using a skill **expression** or a statistical expression. Skill Expression Builder lets you create both types of expressions, which produce a result of true or false.

- For a video tutorial on defining Skills and other objects that can be used in Skill Expression Builder, see [Defining Agents, Agent Groups, and Skills](#).
- For a video tutorial on using Skills as routing targets, see [Skills-Based Routing](#).

Using Skill Expression Builder

Open Skill Expression Builder from the Targets property in the **Target** block as follows:

1. If you have not already done so, [connect to Configuration Server](#). Otherwise, when selecting a Target of Type **Skill**, Skill and other Configuration Database objects will not be available for selection.
2. Set the [Validate Skill Expressions](#) preference.
3. Opposite the Targets property, click under Value to display the  button.
4. Click the  button. The Targets dialog box opens. An example completed dialog box is shown below.

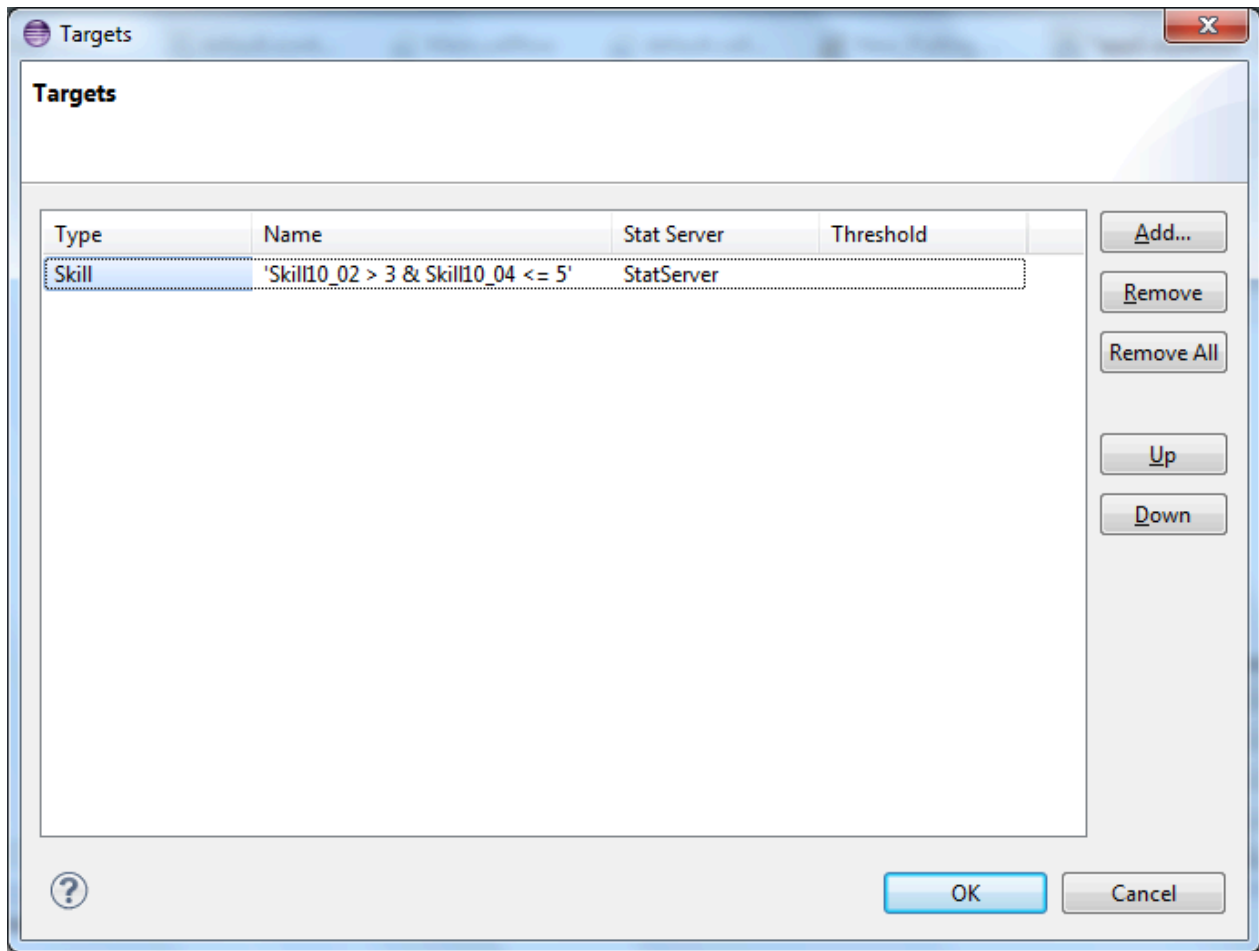

5. Click **Add** in the Targets dialog box.
6. Click under **Type** and select Skill.
7. Click under **Name** to open the Skill Expression Builder.
8. Expand the Skill folder, select a **Skill**. An example completed dialog box is shown below.

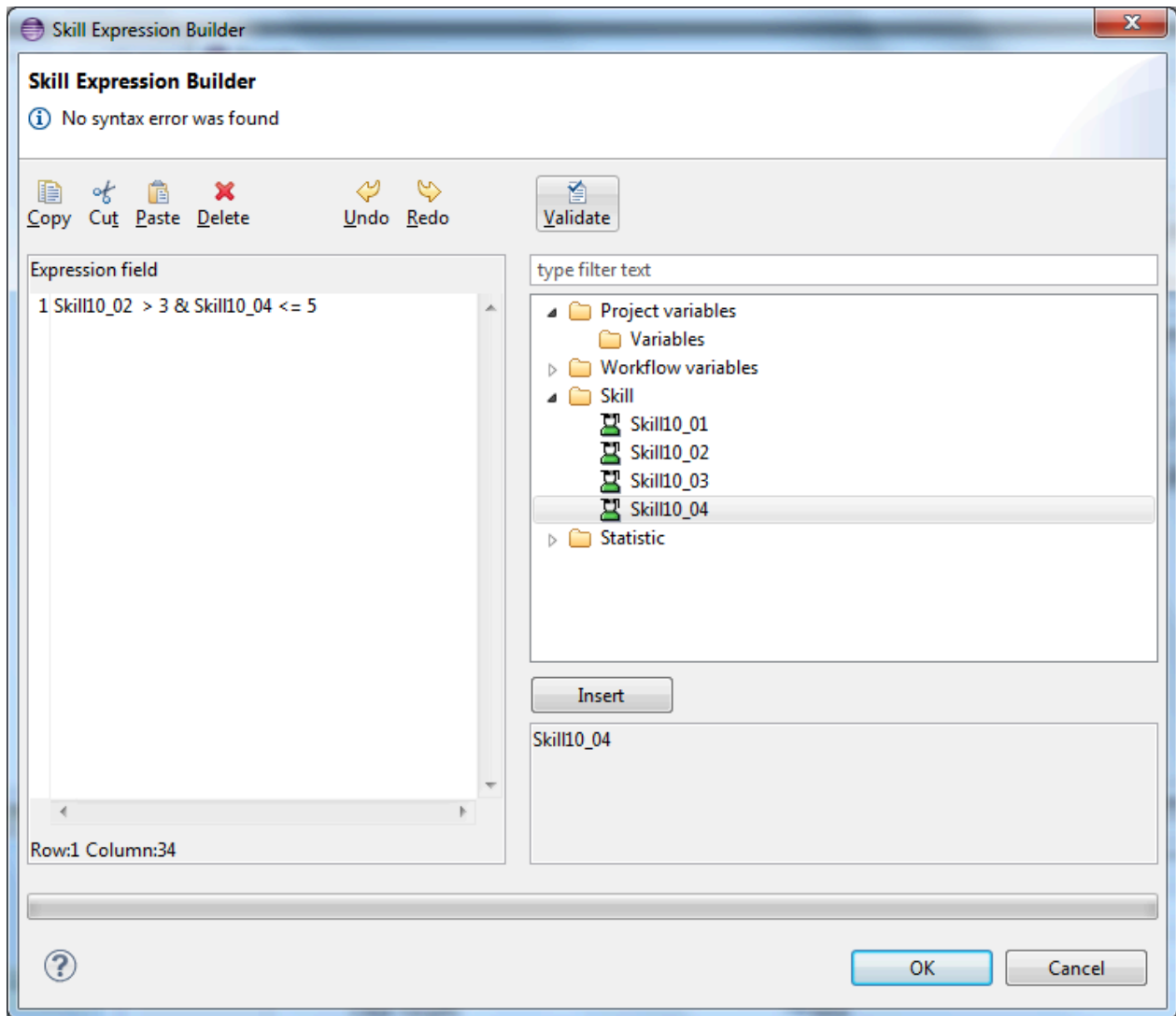

Important

Starting with version 8.1.450.04, single quotes are not added automatically for multi-byte characters, if not provided by the user in the expression.

You can also use variables and/or Statistics.

Variables

Valid and invalid examples are shown below.

site = 1 & english = 1 & account = 1 is not a valid expression

'site = 1 & english = 1 & account = 1' is a valid expression

Because Composer is able to validate 'site = 1 & english = 1 & account = 1', it

automatically adds the missing quotes
`site = vsite & english = vlanguage & account = vaccount` is not a valid expression
`'site = ' + vsite + ' & english = ' + vlanguage + ' & account = ' + vaccount` is a valid expression

Statistics

The statistic name in a skill expression can be any agent statistic used in URS function SData, which returns the current value of the statistic for a given target. For example, you may wish to have URS return the number of interactions waiting, so that if a target is not available, the caller will hear the IVR announce the number of interactions ahead of him. The selected elements appear under Expression. The statistic must be written in the format: `$(statisticname)`. For example:
`$(StatAgentLoggedIn)=1`

9. Under Skill Expression on the left, define the Skill Expression. Skill Expressions are limited to alphanumeric characters and underscores, cannot begin with a digit, and cannot exceed 126 characters.
10. Click **OK**.
11. Back in the Targets dialog box, you have the option of entering a **threshold function** for conditional routing.

Skill Function

Beginning with release 8.1.530.17, a new category folder, Skill Function, is added to the Skill Expression Builder. Currently, it contains the `sitex()` function.

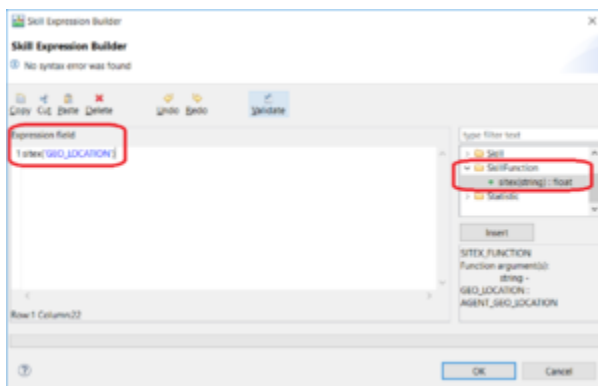

You can use the `sitex()` function to route interactions to targets based on their location. For example, `sitex(GEO_LOCATION) & English > 0`. For more information on the `sitex()` function, refer to the [sitex\(\)](#) function description in the URS documentation.

Important

`GEO_LOCATION` must be specified at the Application level in SIP Server. Routing based on location using the `sitex()` function will work only in environments with **SIP Cluster**.

Using Statistic

1. Expand **Statistic**. URS predefined statistics appear for selection.
2. Select a **statistic**.
3. Click a comparison symbol.
4. Create the expression using a combination of the **comparison operators**, functions, values, and variables. an example is shown below:

```
$(RStatCallsInQueue) = 3 & $(RStatCost) = 2 | $(PositionInQueue) >=6.
```

Note: Use of the RStatCost statistic requires that you have cost-based routing implemented at your site. For a description of each statistic, consult the *Universal Routing 8.1 Reference Manual*.

5. Click the button to validate on the toolbar.
6. Click **OK** when through creating the expression to return to the Targets dialog box.

Comparison Symbols

The table below describes the comparison symbols used to evaluate a skill condition.

Symbol	Interpretation
!=	Differs depending on the Data type: Skill-not equal to the indicated level value. Statistic-not equal to the indicated statistic value.
<	Differs depending on the Data type: Skill-less than the indicated level value. Note: depending on how you use this operator, it may result in including agents that do not have the skill at all (skill name = 0). For example, with English < 8, the queue functional module includes all agents with the English skill less than 8, and also agents with no English skill at all. Statistic-less than the indicated statistic value
<=	Differs depending on the Data type: Skill-less than or equal to the indicated level value. Statistic-less than or equal to the indicated statistic value
=	Differs depending on the Data type: Skill-equal to the indicated level value. Statistic-equal to the indicated statistic value.
>	Differs depending on the data type: Skill-greater than the indicated level value. Statistic-greater than the indicated statistic value
>=	Differs depending on the Data type: Skill-greater than or equal to the indicated level value. Statistic-greater than or equal to the indicated

statistic value.

This is a value of the same data type as the Data name element. The value must already evaluate to an integer. Float numbers are not supported. There are different limitations depending on the data type:

- **Skill value**—This value represents the level of skill. For example; an agent could have an English skill level greater than 3 (English > 3). An agent can be excluded from a skill by setting that agent's skill level for that skill to zero in the configuration layer (English=0).
- **Statistic**—This value represents the value of the statistic/metric. For example; an agent could be in Ready state longer than 20 seconds ($\$(StatTimeInReadyState) > 20$).

Logic Operators

Use the logic operators to evaluate multiple conditional expressions together. The following logic operators are supported:

- **AND** (&)
- **OR** (|).

The AND and OR logic operators have the same priority. For example:

English >3 & $\$(StatAgentLoggedIn)=1$

Variables and Literals

Starting with 8.1:

- Composer supports variables in skill expressions (they appear in the Skill Expression builder tree).
- You must enclose literal expressions in single quotes.

Background: Previously, Composer automatically added single quotes around the expression entered by the user. Now that variables are supported, Composer must distinguish literal strings and variables. As a result, you must enclose literal strings in single quotes.

Also see: [Variables Project and Workflow](#) and the [Chat Transcript block](#).

List Objects Manager

Note:

- Starting with Composer 8.1.4, you can specify a List object as a routing target in the **Targets property** of the Target block.

A List object contains strings of any nature (for example, DNIS or ANI strings), which can be used in strategies. The strings can be as simple as 800 numbers or as complex as routing conditions.

For example, you may use a List object to create lists of toll-free numbers. Rather than reference each individual 800 number in a strategy, you can logically group numbers together and name the group. Then, when you need to add new numbers or edit numbers, you do not need to edit the strategy, but only the List object properties.

Providing key-value pairs for a List element enables you to store information in the Configuration Server Database and then retrieve it from the strategy.

You can specify a List Object **variable** when specifying targets in the Target selection block.

Creating List Objects

Composer supplies a List Objects Manager view to create List objects. To bring up the view and create a List object:

1. If you have not already done so, **connect to Configuration Server**.
2. From the Window menu, select **Show View > List Objects Manager**. You can customize the Show View menu to show List Objects Manager: **Window > Customize Perspective**.
3. Right-click the Transaction folder, select **New Folder**, and name the folder.

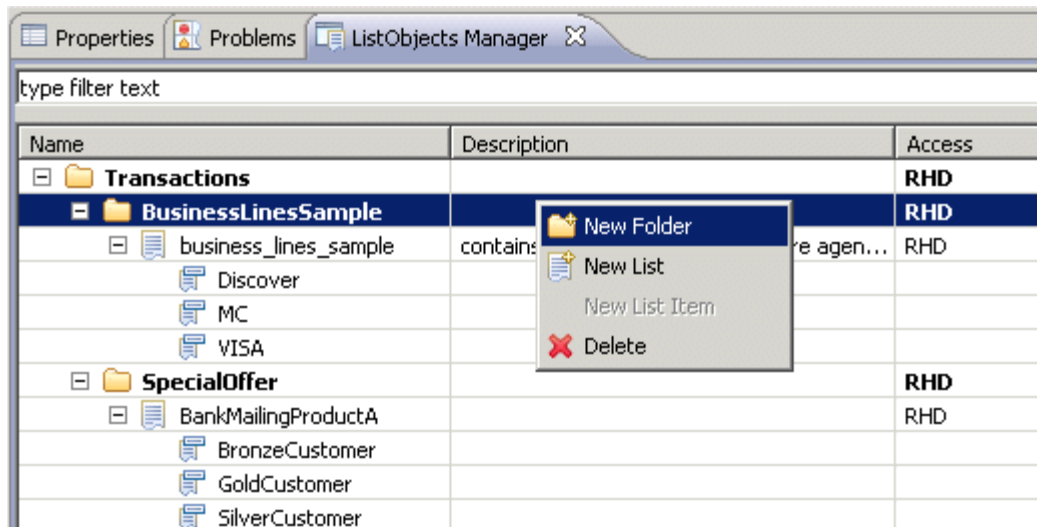

4. Right-click the new folder and select **New List**. Or use the Add New List button on the right.
5. In the Create New List Object dialog box, name and describe the List object and click **OK**.
 - Right-click the name of the List object and select **New List Item**. The dialog box for defining a List item opens.

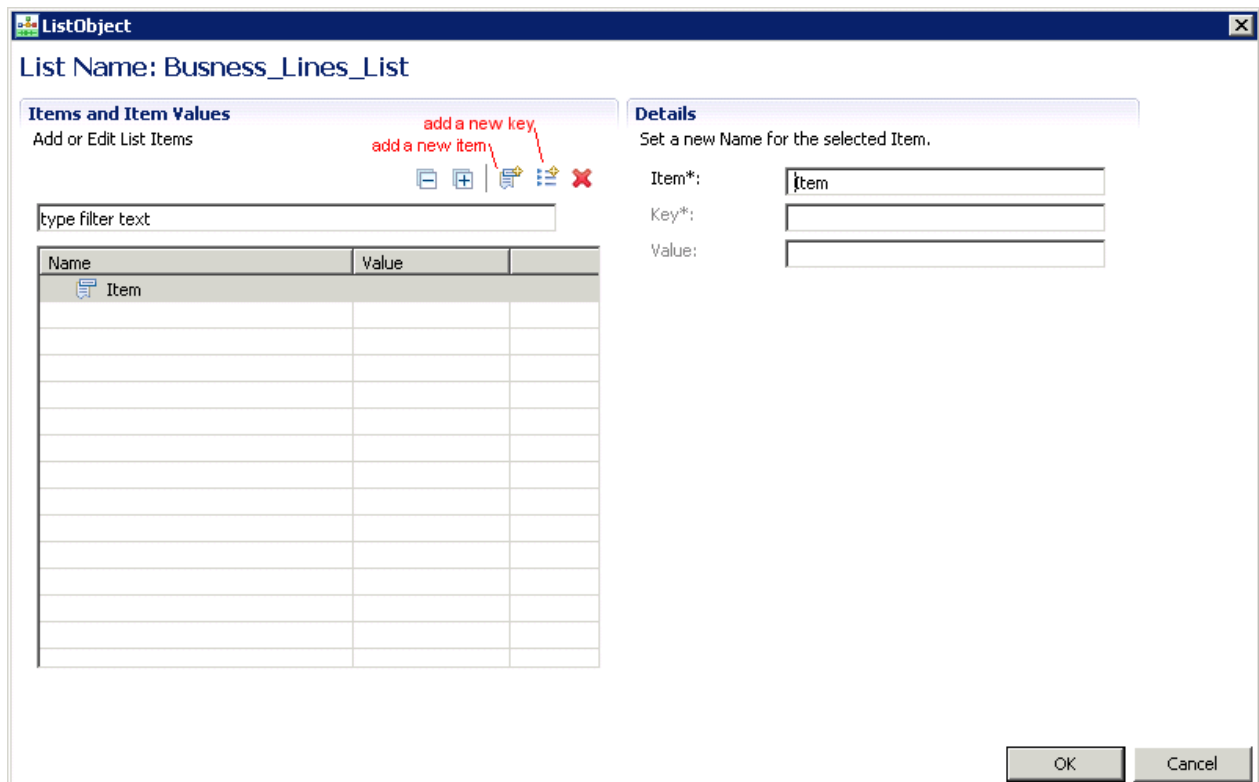

6. On the toolbar, click the button to add a new item.
7. Under **Details**, enter a name in the Item field and click **OK**.

8. Continue adding rows in the List object in this fashion.
9. When through adding rows, in the List Object Managers tab, double-click a row.
10. When the row is selected in the List Object dialog box, click the button to add a new key.
11. Under **Details**, enter the **Key** and **Value** fields.
12. Click **OK**.
13. Continue adding key-values to rows in this fashion.

Sample

Besides individual items, parts of expressions (or an entire expression) can be stored outside of a strategy inside a List object. The sample below is a List object that contains routing information that URS can use to decide when to borrow and lend agents among business lines.

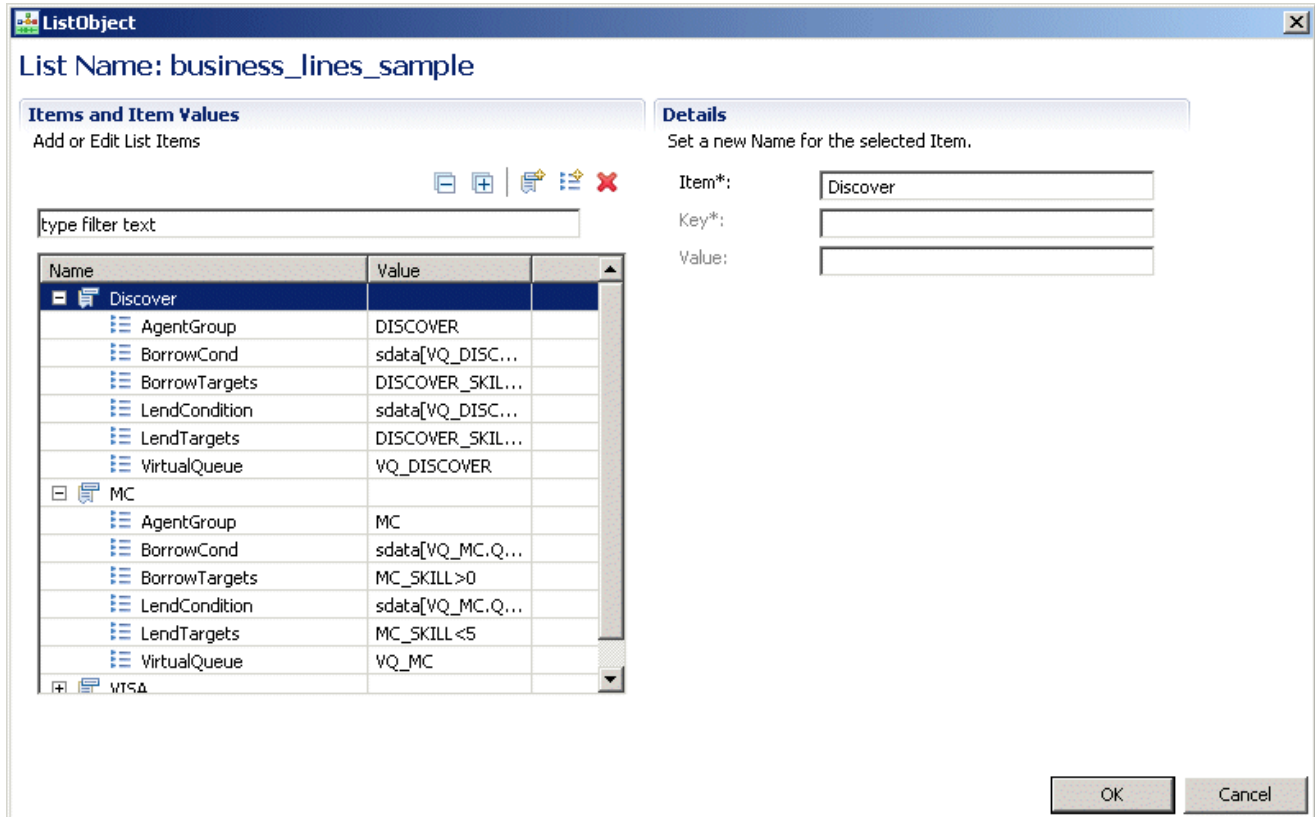

In this sample:

- An IVR has identified customers as wanting information on the MC, VISA, or DISCOVERY business line.
- The requested business line information has been passed to the calling strategy.
- The strategy has segmented interactions to take different paths based on the requested business line.

- If all agents serving the requested business line are busy, URS can use information in the List object to borrow agents from other business lines.

Expression Builder Functions for List Objects

In **Expression Builder**, two **URS functions** can be used to access List Objects:

- `_genesys.session.listLookupValue`
- `.genesys.session.getListItemValue`

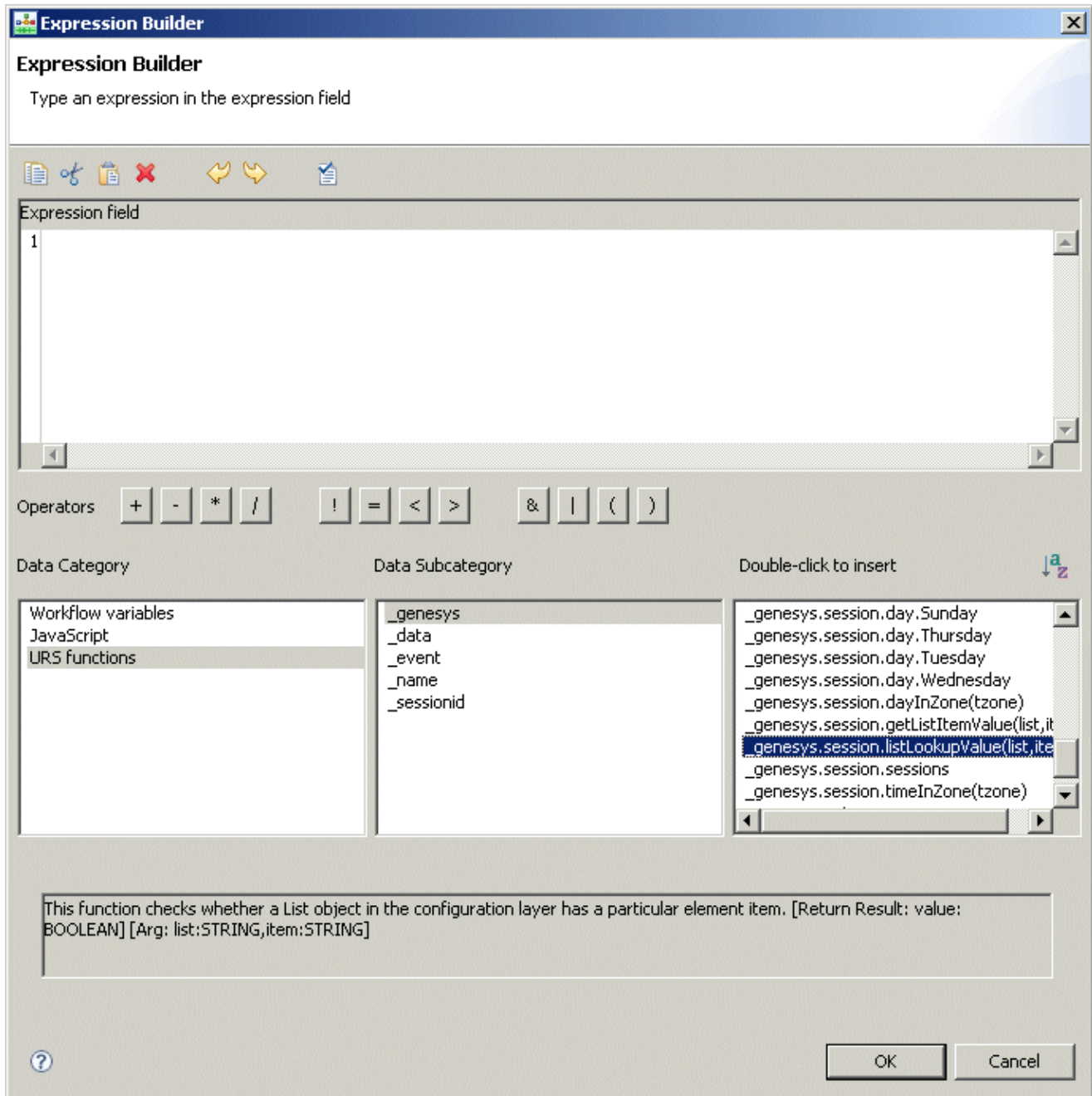

Refer to *Universal Routing SCXML API Reference* help file for details on these functions (Help > Contents).

Statistics Manager and Builder

When using the **Target** object in a strategy, the **Statistics** property lets you route based on the value of a **statistic**. The statistic can be a **URS Predefined statistic** (as described in the *Universal Routing 8.1 Reference Manual*) or a statistic that you create yourself with Statistics Builder. Once you create a statistic, that statistic becomes available for selection in the Target object.

Using Statistics Manager

The Statistics Manager view lets you easily create, delete, and organize created statistics into folders.

You can **connect to Configuration Server** before or after opening the Statistics Manager view. When not connected, the view shows the message: Configuration Server is not connected. You must set the option to use **URS Predefined statistics** if you want to use the URS predefined statistics in a workflow and if those statistics do not already exist in Configuration Server.

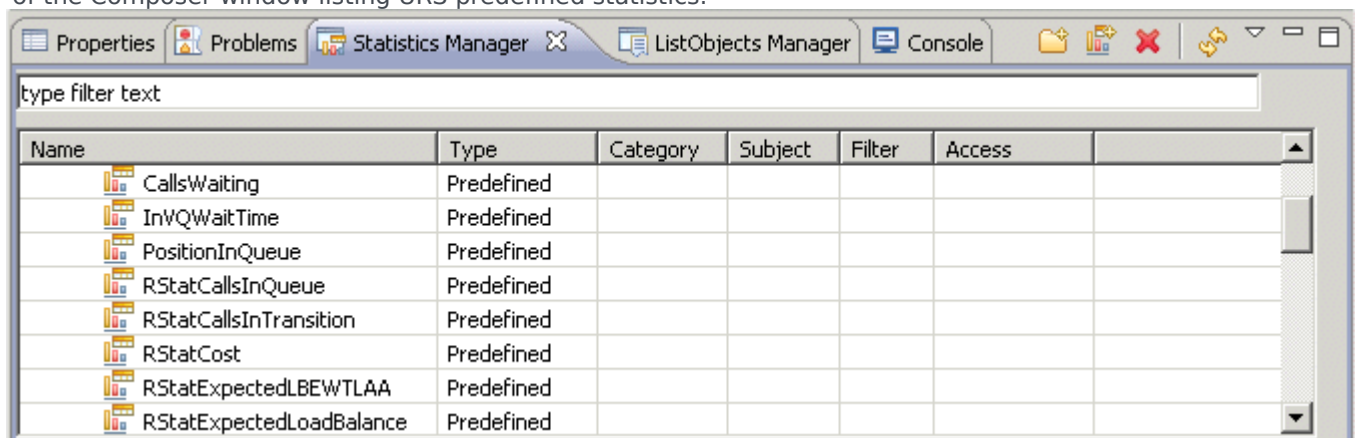

To bring up the Statistics Manager view:

1. Click the Statistics Manager  button on the main toolbar. Alternative methods: Select **Window > Show View > Statistics Manager**. You can customize the Show View menu to show Statistics Manager: **Window > Customize Perspective**. The Statistics Manager view appears along the bottom of the Composer window listing URS predefined statistics.



StatisticsMgr.gif

2. In the Statistics Manager view, you can do the following:
 - Double-click a statistic to edit with Statistics Builder.
 - Right-click a folder under **Name** and select **New Statistic**. Or with a folder selected, click the **Add New Statistics**  button.

- Create a new folder by clicking the **Add New Folder**  button.
- To delete a statistic that you have created, select the statistic and click the  button to delete. Or right-click the statistic and select **Delete**. Note: You cannot delete any of the URS predefined statistics.

Using Statistics Builder

An example Statistics Builder dialog box is shown below.

The screenshot shows a dialog box titled "Statistic Builder" with the following fields and options:

- Name*:** An empty text input field.
- Description:** An empty text input field.
- Category:** A dropdown menu with "TotalNumberInTimeRange" selected.
- Filter:** A dropdown menu.
- + Statistic type:** Queue/Routing point
- + Main Mask:**
- + Relative Mask:**
- + Interval:** Last Second
- + Java**

At the bottom of the dialog are "OK" and "Cancel" buttons.

To create a new statistic:

1. Enter a **Name** for the statistic.
2. Enter a **Description** for the statistic
3. Select the **Category** for the statistic, which tells Stat Server how to calculate the statistic. For information on statistical categories, see the "Statistical Categories" chapter of the *Framework Stat Server User's Guide*.
4. Enter a **Filter** name (optional). Filters enable you to exclude interactions based on certain criteria specified in a logical condition. They enable you to restrict the Stat Server actions that are taken into account during the computation of aggregate values. In a filtered statistic, only those actions are considered that satisfy a filter condition on certain attributes of T-Events. For more information, see

Filters Section in the “Statistic Configuration Options” chapter of the *Framework Stat Server User’s Guide*. If you enter a Filter name that does not exist, the object will be created with the Statistic when you click OK.

5. Select the appropriate radio button to configure one of the following types of statistics:
 - **Queue/Routing Point**
 - **Agent/Group**
 - **Campaign**
6. Select from **Main Mask** and **Relative Mask**. A mask is a list of actions or statuses that apply to the statistic category. Depending on the type of statistic you select (**Queue/Routing Point**, **Agent/Group**, or **Campaign**), the Mask listing shows different actions or statuses. Where several masks are listed, you may select all of them. For lists of actions and statuses, see the chapters on “Stat Server Actions” and “Object Statuses” in the *Framework Stat Server User’s Guide*.
7. Enter **Interval: Last Second**. Refers to the time interval used for calculating historical aggregate values for statistics. Clients, such as CCPulse+, specify which defined time profile to use when requesting their statistics. Options are **Last Seconds**, **Last Calls**, **Growing Window**, and **Since Login**. For more information on intervals, see the Time Profiles section in the “Statistic Configuration Options” chapter of the *Framework Stat Server User’s Guide*. Note: In most routing decisions, the interval over which statistics are measured (if applicable) should have a fixed length. The Growing Window option is intended for exceptional cases and should be used infrequently.
8. **Java**. You have the option to enter:
 - **Extension**—Stat Server architecture includes support for pluggable statistical modules written in Java. This enables you to dynamically extend Stat Server functionality with new statistical types (residing in Stat Server’s Java Extensions [SSJE]) and to have Stat Server supply them to Genesys applications. It is through this functionality that Stat Server processes information from Interaction Server. For more information on this field, see the *Framework Stat Server User’s Guide*.
 - **Subcategory**—The name of the Java subclass that implements statistic calculation.
9. Click **OK**.

Orchestration Extensions

Starting with 8.1.4, Composer blocks used to build routing applications (with the exception of the Disconnect and EndParallel blocks) add a new ORS Extensions property. Use this property to add custom attributes into any/all states and sub-states for any block they are configured in. Add the ORS Extensions property to the Properties view for a selected block by clicking the **Show Advanced Properties** button.

Show Advanced Properties

When creating a new diagram in Composer perspective, this button appears on the right side of the Composer GUI, between the palette of blocks and the Properties view.



This property gives the ability to use any attribute [Orchestration Server](#) supports in addition to the SCXML standard. For information on these attributes, see the attributes prefixed with "_" in the [SCXML Elements](#) section of the *Orchestration Server Developer's Guide*. For example, you can specify additional attributes to be added into the SCXML <state> element, which Orchestration Server can then use to control [persistence](#) on a <state> level and for other functionality in the future.

Orchestration Options

Selecting Properties from the Project menu opens a dialog box showing the properties of the selected Project or of the Project that contains the selected resource. Select [Orchestration Options](#) to view other settings.

Service Level Routing

Genesys uses *Business Priority Routing* as an umbrella term to describe a set of capabilities enabling contact centers to achieve Service Level optimization by its ability to take various factors consideration when making routing decision. For example, you may want to specify a Service Factor for a certain types of customer (gold) and distribute 60% of these customer interactions in less than 10 seconds to a specific agent group. In addition, you can further refine target selection by specifying "best fit" skills and by selecting the minimum or maximum value of a statistic for a Stat Server(for example, StatTimeInReadyState). You can select the interaction with greatest risk to Service Objective as the highest routing priority for an agent, without the need for complex strategy writing.

The contact center administrator defines *Business Attributes* in business friendly terms within Configuration Database (using Genesys Administrator), and the Composer workflow (strategy) writer/developer associates each interaction with these predefined attributes. Some example Business Attributes you can define include:

- **Customer Segment**
- **Service Type**
- **Media Type**
- **Service Objective**

You also can create workflows to fine-tune interaction prioritization using a straight-forward numbering system. For example, you can use:

- **What-If Wait Time** - Interaction is selected by evaluating a "what-if" scenario, such as how much longer will the interaction wait be if this routing opportunity is missed. Router then routes the interaction with the longest what-if wait time first. What-if Wait Time balances routing priority in overstaffed and understaffed queues.
- **Service Objective Risk Factor** - Calculates the risk factor and selects the interaction among various virtual queues with highest risk to service objective as highest routing priority. Service Objective Risk Factor enables best possible chance that all service level objectives for all interactions are met, without having to add more agents.
- **Age of Interaction**, which is the cumulative time a customer has spent since reaching the first routing point -- is known and tracked. With Age of Interaction, customers who call in and have multiple department or agent collaboration needs are not penalized by having to re-queue upon transfer. More about Age of Interaction below.

The use of these factors in routing strategies greatly enhances the contact center's ability to be more business-oriented and strategic to its organization. It improves the chance that all interactions (with varying Service Level goals) are handled within their assigned Service Level objectives based on their value to the organization.

Age of Interaction

Age of interaction can be commenced from your point of choice. It could be from before the customer enters self-service in the IVR, or as the customer exits the IVR to reach a human. If it is stamped/ commenced from prior to the IVR, the priority is set as if the customer has been in queue the entire time (even though reporting does not necessarily show that customer in queue). This means your business can promote self-service capabilities and mention to the customer that we will keep their position in queue while they are self serving.

The commenced point does not have to be changed when the call RONAs or is rejected by an agent. This means that automatically the interaction is placed back into the same position in queue as it was previously (for example, in the front) without any extra coding required. Age of Interaction also useful when the customer enters the contact center, speaks with an agent, and then needs to be transferred to another queue. This capability keeps their priority as if they have been in their transfer queue the entire time since they entered the contact center. This reduces agent time if they perform a warm transfer and enhances the customer experience.

Even in a blind transfer scenario to queue this significantly improves the customer experience, is simple to implement, uses business-friendly language, prevents priority locks, and should be your go-to choice for all of our customers. And then add another layer of capabilities on top or deviate when the business requirements dictate.

Configuring Service Level Routing

1. Configure the Service Type Business Attribute. Add Service Types required, i.e. Service, Active Trader, and so on.
2. Configure the Customer Segment Business Attribute. Add Customer Segments required, i.e. High Net Worth, Mass Affluent, and so on.
3. Configure Objective Table. Name the table. Set type = default. Add Objective Records:
 - **Media Type** = type of media
 - **Service Type** = one of the defined service types from #1
 - **Customer Segment** = one of the defined customer segments from #2
 - **Objective Goal** = time in seconds you want call routed by
 - **Objective Delta** = Service Objective Delta defined for this Record. Defines the step for Service Objective Goal deviation.
4. In the workflow Configure an ECMA script with the findServiceObjective function. The true parameter at the end of the findServiceObjective function attaches the Service Type, Customer Segement and Service Objective to the call. See the data snippet below:

```
'CustomerSegment'      'default'
'ServiceType'          'default'
'ServiceObjective'     '100'
vSvcObjective=_genesys.queue.findServiceObjective(system.InteractionID, '<name of
Objective Table',
0,'<Service Type>' , '<Customer Segment>' , true);
```

The return value of from the above function is the Objective Goal defined in #3. The function below defines how the functional

module handles interactions with the same priorities. By default, interactions with the same priority are ordered according to the time the interaction began to wait for some target.

```
genesys.queue.priorityTuning( _data.ixnid, <useAge> = true|false, <usePredict> = true|false, <useObjective> = true|false );
```

TIP: The Service Objective, Service Type and Customer Segment don't have to be created in the Configuration Database. They just have to be attached to the interaction prior to calling priority tuning. For example:

```
'CustomerSegment'      'default'  
      'ServiceType'    'default'  
      'ServiceObjective' '100'
```

Please also be mindful that Genesys does not support what-if/usePredict for eServices/Interaction Server Media Types.

Exception Events

Certain **callflow exception events** and **routing exception events** application blocks have an Exceptions property. The Properties view for the routing Entry block is shown below as an example.

Property	Value
[-] Alias	
Name	Entry1
[-] Exceptions	
Exceptions	
[-] Global Settings	
Variables	Variable(DNIS1,0), Variable(DNIS2,0)

Clicking the  button opens an **Exceptions dialog box** where you can select events to be supported. The voice **Entry block** also has an Exceptions property with a different set of exceptions that can be supported.

Exception Support Levels

Exceptions can be configured at two levels:

1. At the top level in the Entry block using the **Exceptions** property.
2. At the individual block-level for local exception handling using the **Exceptions** property. These block level exceptions may not be present in all blocks.

To support any of these exceptions globally throughout your application:

1. Select the Entry block's **Exceptions** property.
2. Select an event from the **Not Supported** pane, and then click the > button to move the event to the **Supported** pane.

Note: If the same exception is defined at the top level and the block level, the block-level exception takes precedence for that block.

Callflow Event Handling Guidelines

1. For Main callflow:
 - Always handle the default event handlers--disconnect, error, and all.

- If selecting a specific error event type, always place it before any other errors. For example, `error.badfetch.http` must be placed before `error.badfetch`, which must be placed before the error event in the application.
- Select specific handlers like `error.badfetch` only if the application has to handle that exception differently than the generic error or all event handler.

2. For Subcallflows:

- Unless special processing is required at the local level, it is best to handle events at the global level in the Main callflow.

Exception Handling

This section discusses Event Handling and provides some guidelines. The VXML/SCXML interpreters throw exceptions when they encounter errors or conditions for which exceptions are needed so that the condition may be communicated back to the VXML/SCXML application. For example, for voice applications, events such as NOINPUT or NOMATCH in an **Input** block fall under this category. Composer exposes exceptions at two levels:

- the block level
- the overall callflow level

Any exceptions exposed at the block level can be handled at the block level itself. If the exception is thrown, control does not wind its way all the way back to the Entry block. For example: the DB Data block exposes a `dbconnectionerror` exception if connection to a database fails. This exception is thrown and handled at the block level itself: `<form id="DBData1"> <block> <data name="DBData1Data" src="../include/dbrequest.aspx" method="post" namelist="AppStateString db_query db_name db_timeout" /> ... <throw event="error.com.genesyslab.composer.dbconnectionerror" messageexpr="DBData1Data.errorMessage" /> </block> <catch event="error.com.genesyslab.composer.dberror"> <!--handle exception here--> </catch> </form>` The Entry blocks for routing and voice applications also expose a number of exceptions. These are handled in the Entry block itself. The following are some recommendations about good practices in handling exceptions for callflows.

- For the Main callflow, always handle the default event handlers--`disconnect`, `error`, and `all`.
 - If selecting a specific error event type, always place it before any other errors. For example, `error.badfetch.http` must be placed before `error.badfetch`, which must be placed before the error event in the application.
 - Select specific handlers like `error.badfetch` only if the application has to handle that exception differently than the generic error or all event handler.
- For Subcallflows, it is straightforward to handle exceptions that Composer does not expose directly. Any exceptions that are not listed explicitly are thrown as the `all` exception. A branching block can be added to this exception path and a different execution path can be chosen based on the contents of the exception. The conceptual diagram below shows this approach:

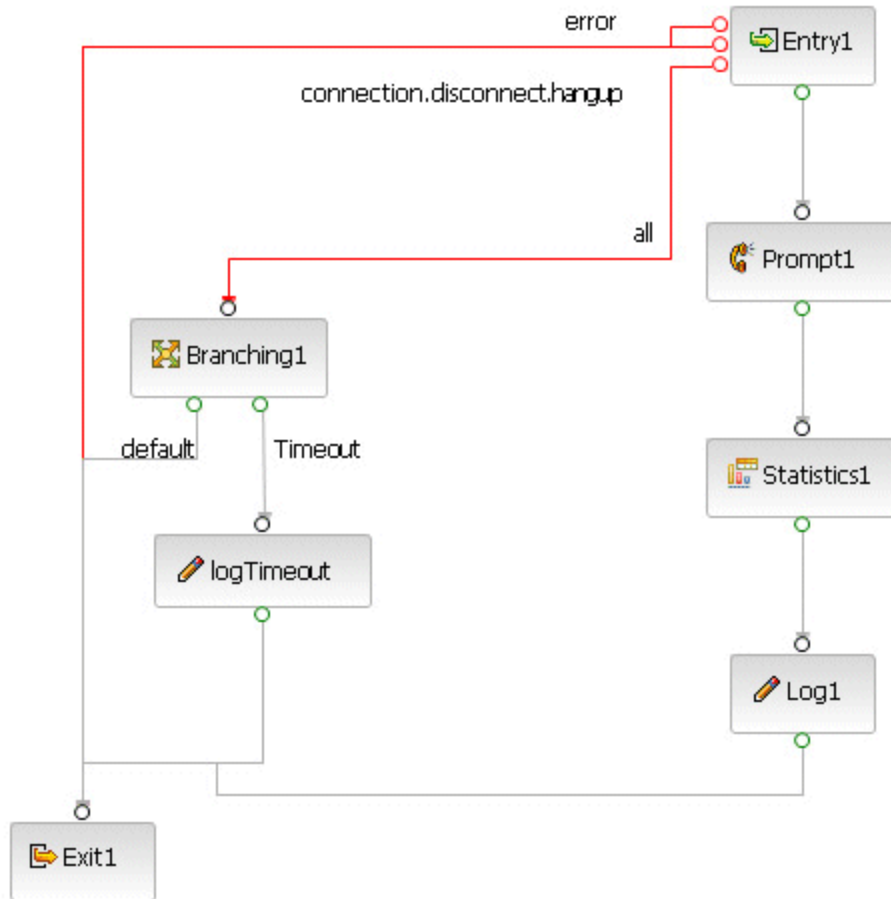

The branch condition will look something like this (variables are described in the [Entry](#) block):

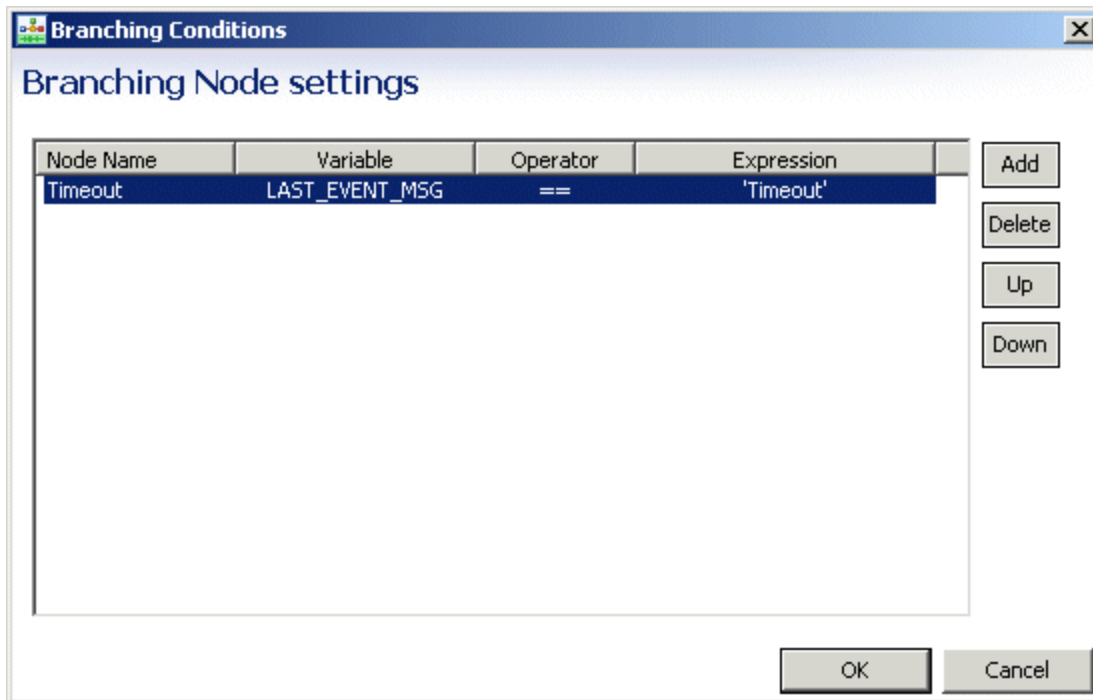

Unless special processing is required at the local level, it is best to handle events at the global level in the Main callflow.

Exception Event Descriptions

The table below names and describes Composer exception events for both callflows and workflows. For callflow VXML events, additional information on events can be found in the [GVP 8.1 Legacy Genesys VoiceXML 2.1 Reference Manual](#).

Exception Event Name	Description
all	This is a generic catch-all exception handler that will catch any exception not handled by the Entry block. It should be the last catch handler in the sequence of exceptions for a block.
cancel	The caller has requested to cancel playing of the current prompt. (Available when the Universals property includes Cancel.)
com.genesyslab.composer.toomanynoinputs	Occurs when the number of no inputs exceeds the maximum retries in Menu, Input, and Record blocks, and blocks do not have local noinput exception ports.
com.genesyslab.composer.toomanynomatches	Occurs when the number of no matches exceeds the maximum retries in Menu, Input, and Record blocks, and blocks do not have a local nomatch exception port.
com.genesyslab.externalmessage	For handling asynchronous external events.

	(Available when <code>com.genesyslab.externalevents.enable</code> is set to true.)
<code>connection.disconnect.hangup</code>	The caller hangs up. Applies at any time except during blind transfers.
<code>connection.disconnect.transfer</code>	The call was "blind transferred" to another line and will not return.
<code>error</code>	The platform encountered any error, such as <code>error.noresource</code> .
<code>error.badfetch</code>	A fetch of a resource failed due to semantic errors in the VoiceXML page.
<code>error.badfetch.badxmlpage</code>	The page that was fetched is an invalid XML page.
<code>error.badfetch.grammar.load</code>	The platform failed to load a grammar.
<code>error.badfetch.grammar.syntax</code>	A grammar has a syntax error.
<code>error.badfetch.grammar.uri</code>	The platform failed to fetch a grammar uri.
<code>error.badfetch.http</code>	A fetch of a resource failed, and the platform returned an HTTP Response failure code.
<code>error.com.genesyslab.composer.badfetch</code>	Bad request.
<code>error.com.genesyslab.composer.badgateway</code>	Bad gateway.
<code>error.com.genesyslab.composer.customernotfound</code>	Context Services Identify Customer Block, Suppress Customer Not Found Exception Property : If set to false (default), this exception is raised when no matching customer is found.
<code>error.com.genesyslab.composer.dbconnectionerror</code>	This error indicates that there was an error encountered while attempting to connect to the database.
<code>error.com.genesyslab.composer.dberror</code>	All database errors (other than <code>dbtimeout</code> and <code>dbconnectionerror</code>) result in this exception. The error text associated with this exception will contain the exact error returned by the database.
<code>error.com.genesyslab.composer.dbtimeout</code>	This error indicates that there was a timeout while waiting for query results to be received from the database. The timeout period is controlled by the <code>Timeout</code> property
<code>error.com.genesyslab.composer.dbemptyresultset</code>	This error indicates that the query or a stored procedure execution resulted in an empty result set, i.e., No records were returned. If the application will handle this condition and the exception is not required to be thrown then it can be suppressed using the Suppress Empty Result Set Exception property .
<code>error.com.genesyslab.composer.forbidden</code>	Forbidden plus specific error message from the server.
<code>error.com.genesyslab.composer.invalidkey</code>	This is the event error for handling an invalid key name. For example, the <code>userdata</code> key being accessed by the Interaction Data block is not a valid key.

error.com.genesyslab.com.composer.notauthorized	Not authorized.
error.com.genesyslab.com.composer.notfound	Not found.
error.com.genesyslab.composer.operationtimeout	This error occurs when the request for Userdata, AccessNumGet, or Statistics times out at the lserver.
error.com.genesyslab.composer.receiveerror	This error occurs when the lserver is down at the udata(getstat,AccessNumget) request.
error.com.genesyslab.composer.recordCapture.failure	Error occurred while saving the recorded file on the Web server side.
error.com.genesyslab.composer.servererror	This error occurs when there is an error in processing the request for the server side blocks such as "Invalid parameters" or "Web server is down." For Context Services blocks: Internal Server Error plus specific error message from the server.
error.com.genesyslab.composer.serviceunavailable	Service unavailable.
error.com.genesyslab.composer.webservice.batchfetch	For attribute descriptions, see the SCXML Language Reference
error.com.genesyslab.customernotfound	For attribute descriptions, see the SCXML Language Reference
error.com.genesyslab.composer.unsupported	This error occurs when the CTI applications designed for CTIC supported features like AccessNumget, Statistics, Interaction-Delete, Replace are called against a SIP Server environment.
error.com.genesyslab.subdialog.maxdepthexceeded	Error when subdialog depth limit is exceeded.
error.connection	This is the base exception for any connection-related error. For example, error.connection.protocol.nnn is thrown when the protocol stack for the connection raised an exception in the case of a bridged transfer. This error can be caught using this base exception.
error.connection.baddestination	The destination URI is malformed in the Transfer block.
error.connection.noauthorization	The caller is not allowed to call the destination, after initiating a transfer using the Transfer block.
error.connection.noresource	The platform could not allocate resources to place the call initiated by the Transfer block.
error.connection.noroute	The platform was not able to route the call to the destination, in a case where the destination URI (phone number) has the correct format.
error.dialog.collect	For attribute descriptions, see the SCXML Language Reference .
error.dialog.continue	For attribute descriptions, see the SCXML Language Reference .

error.dialog.createann	For attribute descriptions, see the SCXML Language Reference .
error.dialog.deleteann	For attribute descriptions, see the SCXML Language Reference .
error.dialog.play	This indicates that an error occurred while trying to perform the <play> request. For attribute descriptions, see the SCXML Language Reference .
error.dialog.playandcollect	This indicates that an error occurred while trying to perform the <playandcollect> request. For attribute descriptions, see the SCXML Language Reference .
error.dialog.playandverify	For attribute descriptions, see the SCXML Language Reference .
error.dialog.playsound	This indicates that an error occurred while trying to perform the <playsound> request. For attribute descriptions, see the SCXML Language Reference .
error.dialog.remote	For attribute descriptions, see the SCXML Language Reference .
error.dialog.setdialogdefaultdest	This indicates that an error occurred while trying to perform the <setdialogdefaultdest> request. For attribute descriptions, see the SCXML Language Reference .
error.dialog.start	This indicates that an abnormal condition occurred while trying to perform the start request. This event will be sent as a result of a timeout of the request as well as problems with the request itself. For attribute descriptions, see the SCXML Language Reference .
error.dialog.stop	This indicates that an error occurred while trying to perform the <stop> request. For attribute descriptions, see the SCXML Language Reference .
error.interaction.redirect	For attribute descriptions, see the SCXML Language Reference .
error.msgbased.createmessage	This event is sent when the <createmessage> request has failed for some reason.
error.msgbased.sendmessage	This event is sent when the <sendmessage> request has failed for some reason.
error.noresource	The specified language is not supported by the TTS/ASR server, or the TTS/ASR server/service is down.
error.noresource.recording	Occurs when MCP fails to start the GIR recording for any reason. For callflow VXML events, additional information on events can be found in the GVP 8.1 Legacy Genesys VoiceXML 2.1 Reference Manual .
error.queue.cancel	For attribute descriptions, see the SCXML Language Reference .

	Reference.
error.queue.default	For attribute descriptions, see the SCXML Language Reference.
error.queue.query	For attribute descriptions, see the SCXML Language Reference.
error.queue.start	For attribute descriptions, see the SCXML Language Reference.
error.queue.stop	For attribute descriptions, see the SCXML Language Reference.
error.queue.submit	<p>This indicates that an abnormal condition occurred while trying to perform the submit request. This event will be sent as a result of a timeout of the request as well as problems with the request or interaction itself.</p> <p>Busy treatment exceptions are raised as the error.queue.submit exception and not as exceptions listed in individual treatment blocks. See the routing application Target block for more information.</p>
error.queue.update	For attribute descriptions, see the SCXML Language Reference.
error.semantic	See the GVP 8.1 Legacy Genesys VoiceXML 2.1 Reference Manual.
error.session.fetch	An error occurred while trying to perform the fetch of a resource in a workflow.
error.session.start	For attribute descriptions, see the SCXML Language Reference.
error.session.terminate	For attribute descriptions, see the SCXML Language Reference.
error.unsupported	The platform encounters any error of type unsupported, such as error.unsupported.builtin.
error.unsupported.builtin	The built-in grammar is not supported by the platform or the ASR engine.
error.unsupported.format	An unsupported grammar format or audio format is encountered.
error.unsupported.language	The platform does not support the language for either speech synthesis or speech recognition.
error.unsupported.objectname	The requested object is not supported.
error.unsupported.receive	The application's access to messaging is disabled in MCP. This may be received as a VXML event for <receive> blocks.
error.unsupported.send	<p>The application's access to messaging is disabled in MCP. This may be received as a VXML event for <send> blocks.</p> <p>Note: This will be applicable to all blocks that use <send>, such as the Interaction Data block.</p>
error.unsupported.transfer	This is the base exception for any unsupported

	transfer settings.
error.unsupported.transfer.blind	The platform (configuration) does not support blind transfers, and the application specifies that it wants to do a blind transfer.
error.unsupported.transfer.consultation	The platform does not support consultative transfers, and the application specifies that it wants to do a consultative transfer.
error.unsupported.transrec.type	The platform does not support the media format.
error.unsupported.uri	The platform does not support the URI format (for example, fax://...).
exit	The caller has asked to exit. (Available when the universals property includes exit).
help	The caller has asked for help. (Available when the universals property includes help).
maxspeechevent	The caller input was too long, exceeding the property maxspeechevent.
noinput	The application expects voice or DTMF input, but it has received none from the caller within the timeout interval.
nomatch	The caller input something, but it was not recognized.

Exception Events for eServices UCS Blocks

The following eService blocks for Universal Contact Server use the exception events listed below:

- [Identify Customer](#)
- [Update Customer](#)
- [Create Customer](#)

See the individual block topics for the list of supported exceptions.

Exception Event Name	Error Code	Error Description
error.com.genesyslab.composer.badrequest	400	Bad Request.
error.com.genesyslab.composer.notfound	404	Not Found.
error.com.genesyslab.composer.servererror	500	Internal Server Error + specific error message from Composer.
error.com.genesyslab.composer.nohtml	405	No text found in standard response : <UCS error message>.
error.com.genesyslab.composer.missingparameter	201	Missing parameter name.
error.com.genesyslab.composer.incompatibleparameter	202	Parameter '1' and '2' are not allowed.
error.com.genesyslab.composer.invalidparametertype	203	Incorrect type for parameter

		<parameter_name>, expected type 1 but was type 2.
error.com.genesyslab.composer.invalidparametervalue	204	Incorrect value for parameter <parameter_name>, expected value 1 but was value 2.
error.com.genesyslab.composer.invalidmessagetype	502	Invalid third party message type.
error.com.genesyslab.composer.objectnotfound	510	Object not found in database.
error.com.genesyslab.composer.incorrectsubtype	512	Incorrect subtype for interaction <interaction_name>, expected type 1 but was type 2.
error.com.genesyslab.composer.servererror	704	Unexpected error exception message.
error.com.genesyslab.composer.database	710	Connection to database failed.
error.com.genesyslab.composer.serveroverloaded	716	Server overloaded, request rejected.
error.com.genesyslab.composer.noattributes	730	No searchable attribute.
error.com.genesyslab.composer.invalidtenant	732	Invalid Tenant <tenant_name>.

Working with URS Functions

- You can use SCXML State blocks to work with URS http functions, such as [FindConfigObject](#). For an example code snippet, see [Using the SCXML State Block](#).
- Starting with 8.1.440.18, Composer supplies a [URS Function](#) block.

Working with URS API Calls

You can use SCXML State blocks to work with [Universal Routing Server](#) HTTP functions. This example uses following URS functions:

- FindConfigObject - To find object information in the Configuration Database.
- trek/exec - To register and change agent status.

See [Using the SCXML State Block](#).

Common Voice & Route Functionality

This section describes the Functionality that can be used for both Orchestration routing and GVP voice applications.

Note: Composer does not support copying blocks from a callflow to a workflow or vice-versa.

You can also create [Custom Blocks](#).

Special Note on Entry and Exit Blocks

These two blocks are also present on the palette for both routing and voice applications. The [Entry block for routing applications](#) has a different set of events than the [Entry block for voice applications](#).

Link Tools

Routing and voice applications use the same link tools:

- [Outlinks](#)
- [Exception Links](#)

Composer Help Wiki URL

The URL to the Composer Help wiki is configurable by using the Online Wiki URL field: **Window > Preferences > Help**. The default works with English but if, for example, Japanese pages were available in a different location, then you could change the URL accordingly.

Code Generation

The process of generating code creates a properly-formatted VoiceXML file from a callflow diagram built with Composer or a SCXML file from a workflow diagram. Static pages (pure VXML or SCXML code) are generated in the src-gen folder of the Composer Project.

Generating Code

You can generate code in a couple of ways:

- Select **Diagram > Generate Code**.
- Click the Generate Code icon  on the upper-right of the Composer main window when the callflow/workflow canvas is selected.

Note: If your project uses Query Builder or Stored Procedure Helper-generated queries in DB Data Blocks, the process of code generation creates one SQL file in the db folder for each such DB Data block. These SQL files will be used at runtime and should not be deleted.

Code Generation of Multiple Callflows

When using the Run as Callflow function, Composer automatically generates the VXML files from the diagram file that you want to run. When generating code, with the generate code function for a Java Composer Project that has multiple callflows, Composer attempts to generate the VXML for all the callflows before running (because the application might move between multiple callflows for subdialogs).

However, if one of the callflows has an error, Composer provides the option to continue running the application anyway, because the erroneous callflow may be a callflow that is not used by the one being run (if there are two or more main callflows, for example). When this happens, the VXML files are basically out of sync with the diagram files and this may affect execution. Genesys recommends that you fix all errors before running the application.

Generate All

Use the 'Generate All' feature to generate VoiceXML and SCXML code for all the Diagram files (Callflows, Workflows and IPD) present in a Composer Project.

Generate All can be invoked in two ways.

- Select **Project > Generate All**.

- Click the Generate All icon  on the upper-right of the Composer main window toolbar.

Custom Blocks

A custom block can be thought of as a pre-filled template for a block. Note that when creating a custom block, accessing system resources (include/jsp) across Projects is not supported.

To create a custom block:

1. Add the block to use as the pre-filled template.
2. Fill out the properties to be the basis of the template.
3. Right-click the block to bring up a shortcut menu.
4. From the shortcut menu, select **Add as custom tool**. Note this option is not available for the **IPD blocks**. The Custom Tooling dialog box opens. A sample is shown below.

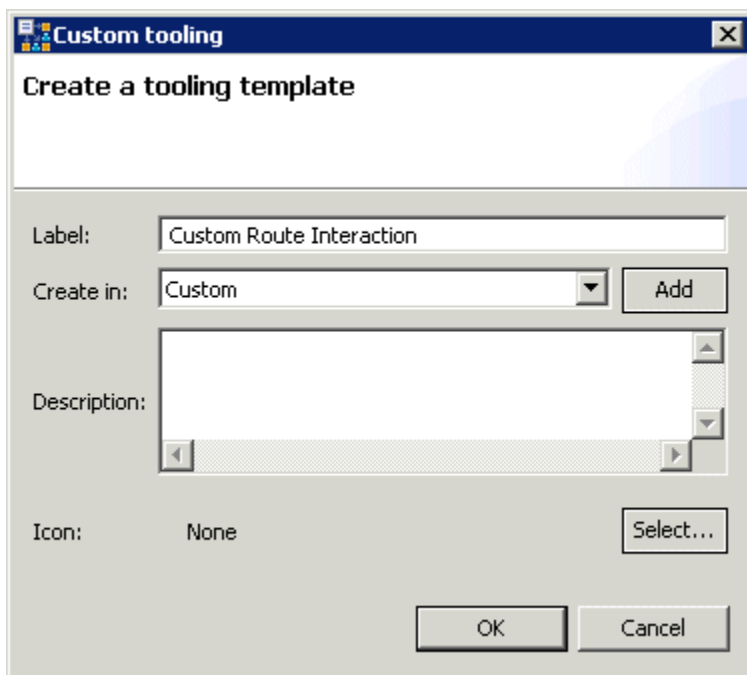

5. Opposite **Create in:**, Leave **Custom** to place the block in the Custom category on the palette. Or click the down arrow and select another palette drawer.
6. If you wish to upload an icon or graphic for the custom block, click **Select** to open the Custom Icon Library dialog box. Select an icon, and click OK. The selected icon appears in the dialog box.
7. Click **OK** in the Custom Tooling dialog box. Composer adds the block to the palette in the selected category.

Note: Custom Entry and Exit icons do not appear on the palette. It still shows the default Entry/Exit icons.

Using a Custom Block

Use the block as you would any others. Fields defined as relevant in the Block Data Map are automatically populated in the Properties tab based on the state of the original block when you made the tooling.

- Note: When you create a new block, you must add a mapping to define which fields should be template-aware.

Changing Existing Custom Blocks To change an existing custom block:

1. Within the palette, right-click a custom block and select Customize... from the context menu. This opens the Customize Palette dialog box.
2. Navigate to/select the block you want to change.

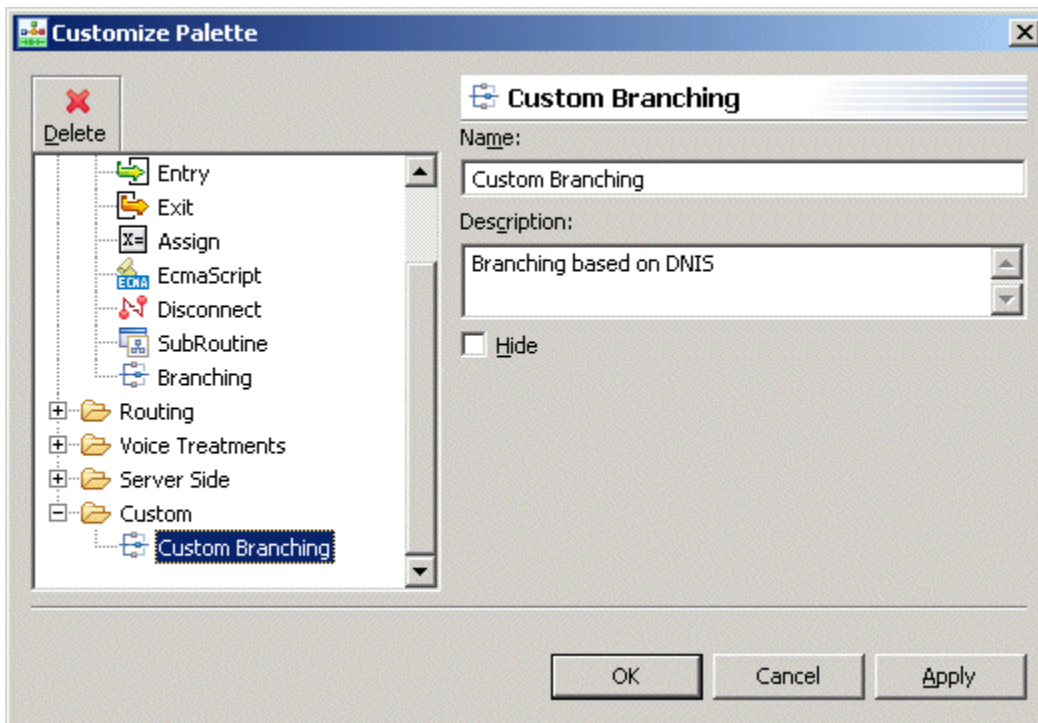

3. You can:

- Change the label.
- Edit the description.
- Delete the block entirely.

Deleting a Custom Block

To delete a custom block:

1. Within the palette, right-click a custom block and select **Customize...** from the context menu. This opens the Customize Palette dialog box shown above.
2. Navigate to/select the block you want to delete.
3. Click the **Delete** button at the top of the Customize Palette dialog box.
4. Click **OK**.

Hiding the Custom Category

To hide the Custom category on the palette:

1. In the Customize Palette dialog box (see above steps), select the Custom folder.
2. Click the **Hide** checkbox. Later, if you need the Custom category back on the palette, select the Custom folder and un-click **Hide**.
3. Click **OK**.

Import/Export of Custom Blocks

To import or export a custom block so that it can be shared across multiple users/Composer installations:

1. Select the custom block in the palette.
2. From the Diagram menu, select:
 - **Import Custom Blocks...** to open the Select Custom Tooling Definition dialog box. Browse to the location for the previously exported custom block file, which will have a *.ctooling extension, select the file, and click **OK**.
 - **Export Custom Blocks...** to open the Create Custom Tooling Definition dialog box. Name the file, keep the file type as custom tooling, and click **OK**. The custom block is saved as file with a *.ctooling extension.

Customization Manager

Purpose

Use Customization Manager to store/manage various aspects of your Composer installation that you have customized. You can store/manage the workflow and callflow diagram templates that you create as described in the [Diagram Templates](#) topic.

Interface

The user interface takes the form of the Customization Manager view. To display this view:

1. Select **Window > Show View > Other**.
2. In the resulting Show View dialog box, select Customization Manager and click **OK**. A Customization Manager view appears at the bottom of the Composer window listing registered plug-ins. An example is shown below.

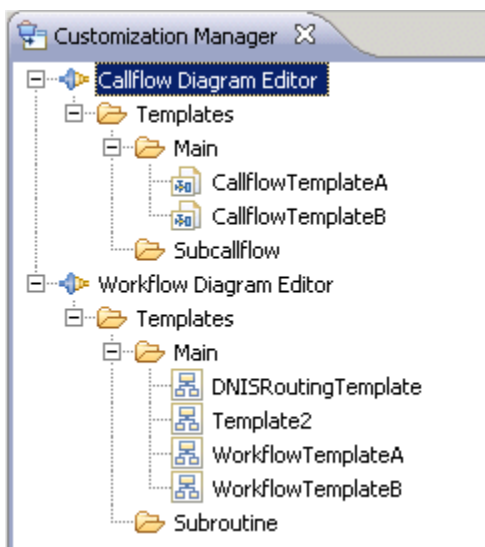

Managing Templates

You can use this view to manage the workflow and callflow diagram templates that you create as described in the [Saving Diagrams as Templates](#) topic. To manage diagram templates:

1. Right-click a callflow or workflow diagram to bring up a menu.

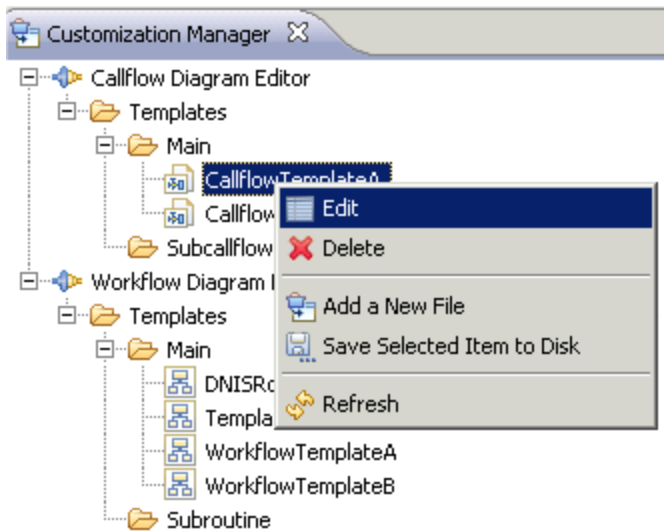

2. Select from the following:

- **Edit**--Use to edit a selected diagram template.
- **Delete**--Use to delete a selected diagram template
- **Add a New File**--Use to import a callflow or workflow diagram.
- **Save Selected Item to Disk**--Use to save a selected diagram to a disk.
- **Refresh**

Customizer Preferences

To bring up Customizer Preferences:

1. Click the **Window** menu.
2. Select **Preferences**.
3. Expand **Composer**.
4. Select **Customizer Preferences**. The Customizer Preferences dialog box opens. The Callflow Diagram Editor and Workflow Diagram Editor customization plug-ins are display only and can be used for debugging.

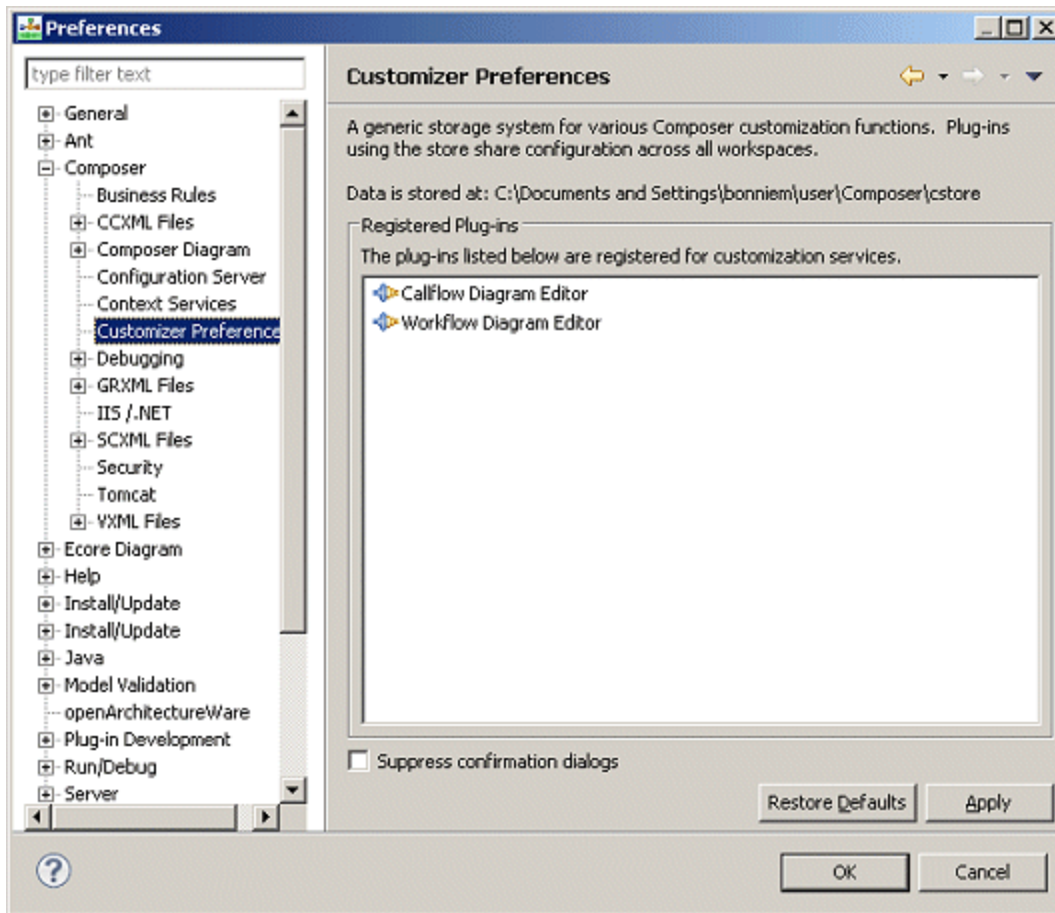

The Customizer Preferences dialog box:

- Reports on the location of the storage area (cstore directory) on disk. Diagrams that you save as templates are stored here.
- Lists registered plug-ins as shown in the Customization Manager view.
- Allows you to suppress confirmation dialogs associated with plug-ins. If checked, it suppresses the success/failure indicator message when you save a diagram as a template.

Diagram Preferences

Select **Window > Preferences > Composer > Composer Diagram**. The following preferences for diagrams can be set in the Preferences dialog box:

Global Settings

1. Select or clear the check box for each of the following diagram global settings:

- **Show Connection Ports.** If enabled, connection ports (both exception ports and out ports) are always displayed on blocks. This makes it convenient to draw links between blocks and to get immediate feedback on how many ports each block provides. However, in this case, the ability to reposition connections on a block is not available. If switched off, connection ports are not displayed by default, but repositioning or finer control over connection link placement becomes available. Note: This preference applies to all projects and is not available for individual projects.)
- **Show popup bars.** If enabled, this setting displays basic blocks from the blocks palette in a pop-up bar if you hover your mouse on the diagram for one or two seconds without clicking. Note: blocks are shown in icon view only.)
- **Enable animated layout.** If enabled, causes diagrams to gradually animate to their location when the Diagram \> Arrange \> Arrange All menu option is clicked.
- **Enable animated zoom.** If enabled, while using the zoom tools, shows a gradual transition between the initial and final state of the diagram on the canvas. If off, the zoom is instantaneous. Similar behavior for animated layout when the Diagram \>\> Arrange \>\> Arrange All menu option is clicked.
- **Enable anti-aliasing.** If enabled, improves the appearance of curved shapes in the diagram. You can see its effect on the circles in the Entry and Exit blocks.
- **Show CodeGen success message.** If unchecked, then the confirmation dialog at the completion of code generation will not be shown.)
- **Prompt to Save Before Generating Code.** If checked, when you generate code for an unsaved diagram, a prompt appears indicating the diagram has been modified and asking if you want to save the changes before generating code. The dialog box also contains a checkbox: Automatically save when generating code and do not show this message again.
- **Show Validation success message.** If unchecked, then the confirmation dialog at the time of Validation will not be shown.)
- **Enable Validation for Prompt Resources.** This preference is used for voice applications. If unchecked, then a validation check for missing prompts is not performed at the time of Validation.
- **Interaction Process Diagram.** If unchecked, Composer will save Interaction Process Diagrams before publishing.
- **Prompt to delete Published objects when Interaction Process Diagram is deleted.** If unchecked, Composer will attempt to delete any Published objects when an Interaction Process Diagram is deleted. If Composer is not connected to Configuration Server, object

deletion will not work.

- **Parameters auto synchronization** (available starting with 8.1.410.14). This option reduces developer coding time by enabling Composer to automatically declare variables in a Main diagram to match input/output variable names in Subdialog block/Subroutine diagrams and to automatically perform the mapping. This feature is available for both user and system variables. For example, if a Subroutine diagram returns a variable called “xyz” and if Composer automatically declares “xyz” in the Main diagram to hold the output, then you do not have to manually do the mapping. If enabled, you are prompted for auto-synchronization whenever there is a need to change parameters names or add new variables in the dialogs.

Scenarios:

1. Subdialog or Subroutine Diagram: Entry Block—The auto-synchronization process will synchronize any newly added/updated variables and existing variables in the Subdiagram. If you add a new Input type variable, a prompt appears asking whether to add a corresponding Input parameter. You are also prompted to select or add the Input source variable in all the called Subroutine diagrams. New parameter naming in the calling Subdialog block is the same as the Input variable added in the Entry Block. If the Subroutine diagram is called from many diagrams, Composer provides a variable selection option for the called diagrams.
2. Main callflow Diagram: Entry Block—If you add a new Input type variable, a prompt appears asking whether to add the corresponding input parameter. You are also prompted to select or add an Input source variable in all the called Play Application blocks. New Parameter naming in the calling Play Application block is the same as the Input variable added in the Entry Block. If the Main diagram was called from multiple Play Application blocks, a variable selection option for all the called blocks is provided.
3. Subdialog or Subroutine diagram: Exit Block—If you change or delete a return parameter, a prompt appears on whether to delete the Output parameter and/or the missing ones in case of a change in all the called Subroutine or Subcallflow diagrams.
4. The auto-synchronization parameter option also applies when there is a change in a configured Subroutine diagram. The auto-synchronization dialog confirmation appears as soon as a Subroutine diagram is added/updated. If the confirmation dialog is selected, it automatically synchronizes the Subroutine parameters to the Main diagram. This auto-synchronization prompt always appear even though the same diagram is updated again. When Output parameters are added in the Exit block, parameter synchronization also occurs.
5. **Application URL for Publish and Debugging.** Select **Use IP Address** or **Use Host Name**.

Notes:

Composer creates unique names for auto-sync variables, such as <SubBlockName>_<VariableName>. SubBlockName is the name of the Subroutine/ Subdialog / Play Application blocks where the Subroutine diagram is being invoked. VariableName is the input variable name created in a Subroutine diagram.

2. Click **Apply**.

Colors and Fonts

1. Select **Appearance** under Composer Diagram.

2. Click **Change** and make selections to change the default font if you wish.
3. Click the appropriate color icon beside any of the following and make selections to change color:

- **Font color**
- **Fill color**
- **Line color**
- **Note fill color**
- **Note line color**

4. Click **Apply**.

Connections

1. Select Connections under Composer Diagram.
2. Select a line style from the drop-down list:

- **Oblique**
- **Rectilinear**

3. Click **Apply**.

Pathmaps

1. Select **Pathmaps** under Composer Diagram.
2. Click **New** to add a path variable to use in modeling artifacts, or If the list is populated, select the check box of a path variable in the list.
3. Click **Apply**.

Printing

1. Select **Printing** under Composer Diagram.
2. Select **Portrait** or **Landscape** orientation.
3. Select units of Inches or Millimetres.
4. Select a paper size (default is Letter).
5. Select a width and height (for inches, defaults are 8.5 and 11; formillimeters, defaults are 215.9 and 279.4).
6. Select top, left, bottom, and right margin settings (for inches, defaults are 0.5; for millimeters, defaults

are 12.7).

7. Click **Apply**



Rulers and Grid

You can make use of rulers and grids when creating diagrams. Rulers and grids can provide a backdrop to assist you in aligning and organizing the elements of your callflow diagrams.

1. Select Rulers and Grid under Studio Diagram.
2. Select or clear the **Show rulers for new diagram** check box (not selected by default).
3. Select ruler units from the drop-down list:
 - **Inches**
 - **Centimeters**
 - **Pixels**
4. Select or clear the Show grid for new diagrams check box (not selected by default).
5. Select or clear the Snap to grid for new diagrams check box (selected by default).
6. Type a value for grid spacing (for inches, the default is 0.125; for centimeters, the default is 0.318; for pixels, the default is 12.019).
7. Click **Apply**.

Exception Events

Certain **callflow exception events** and **routing exception events** application blocks have an Exceptions property. The Properties view for the routing Entry block is shown below as an example.

Property	Value
[-] Alias	
Name	Entry1
[-] Exceptions	
Exceptions	 
[-] Global Settings	
Variables	Variable(DNIS1,0), Variable(DNIS2,0)

Clicking the  button opens an **Exceptions dialog box** where you can select events to be supported. The voice **Entry block** also has an Exceptions property with a different set of exceptions that can be supported.

Exception Support Levels

Exceptions can be configured at two levels:

1. At the top level in the Entry block using the **Exceptions** property.
2. At the individual block-level for local exception handling using the **Exceptions** property. These block level exceptions may not be present in all blocks.

To support any of these exceptions globally throughout your application:

1. Select the Entry block's **Exceptions** property.
2. Select an event from the **Not Supported** pane, and then click the > button to move the event to the **Supported** pane.

Note: If the same exception is defined at the top level and the block level, the block-level exception takes precedence for that block.

Callflow Event Handling Guidelines

1. For Main callflow:
 - Always handle the default event handlers--disconnect, error, and all.

- If selecting a specific error event type, always place it before any other errors. For example, `error.badfetch.http` must be placed before `error.badfetch`, which must be placed before the error event in the application.
- Select specific handlers like `error.badfetch` only if the application has to handle that exception differently than the generic error or all event handler.

2. For Subcallflows:

- Unless special processing is required at the local level, it is best to handle events at the global level in the Main callflow.

Exception Handling

This section discusses Event Handling and provides some guidelines. The VXML/SCXML interpreters throw exceptions when they encounter errors or conditions for which exceptions are needed so that the condition may be communicated back to the VXML/SCXML application. For example, for voice applications, events such as NOINPUT or NOMATCH in an **Input** block fall under this category. Composer exposes exceptions at two levels:

- the block level
- the overall callflow level

Any exceptions exposed at the block level can be handled at the block level itself. If the exception is thrown, control does not wind its way all the way back to the Entry block. For example: the DB Data block exposes a `dbconnectionerror` exception if connection to a database fails. This exception is thrown and handled at the block level itself: `<form id="DBData1"> <block> <data name="DBData1Data" src="../include/dbrequest.aspx" method="post" namelist="AppStateString db_query db_name db_timeout" /> ... <throw event="error.com.genesyslab.composer.dbconnectionerror" messageexpr="DBData1Data.errorMsg" /> </block> <catch event="error.com.genesyslab.composer.dberror"> <!--handle exception here--> </catch> </form>` The Entry blocks for routing and voice applications also expose a number of exceptions. These are handled in the Entry block itself. The following are some recommendations about good practices in handling exceptions for callflows.

- For the Main callflow, always handle the default event handlers--`disconnect`, `error`, and `all`.
 - If selecting a specific error event type, always place it before any other errors. For example, `error.badfetch.http` must be placed before `error.badfetch`, which must be placed before the error event in the application.
 - Select specific handlers like `error.badfetch` only if the application has to handle that exception differently than the generic error or all event handler.
- For Subcallflows, it is straightforward to handle exceptions that Composer does not expose directly. Any exceptions that are not listed explicitly are thrown as the `all` exception. A branching block can be added to this exception path and a different execution path can be chosen based on the contents of the exception. The conceptual diagram below shows this approach:

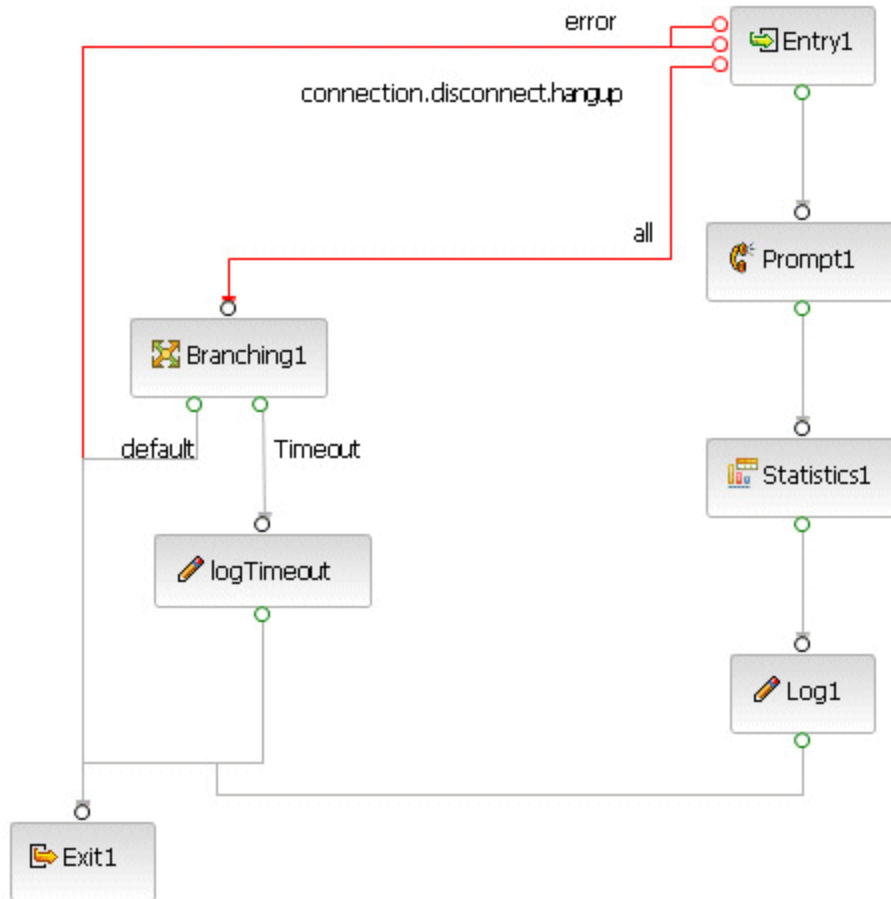

The branch condition will look something like this (variables are described in the [Entry](#) block):

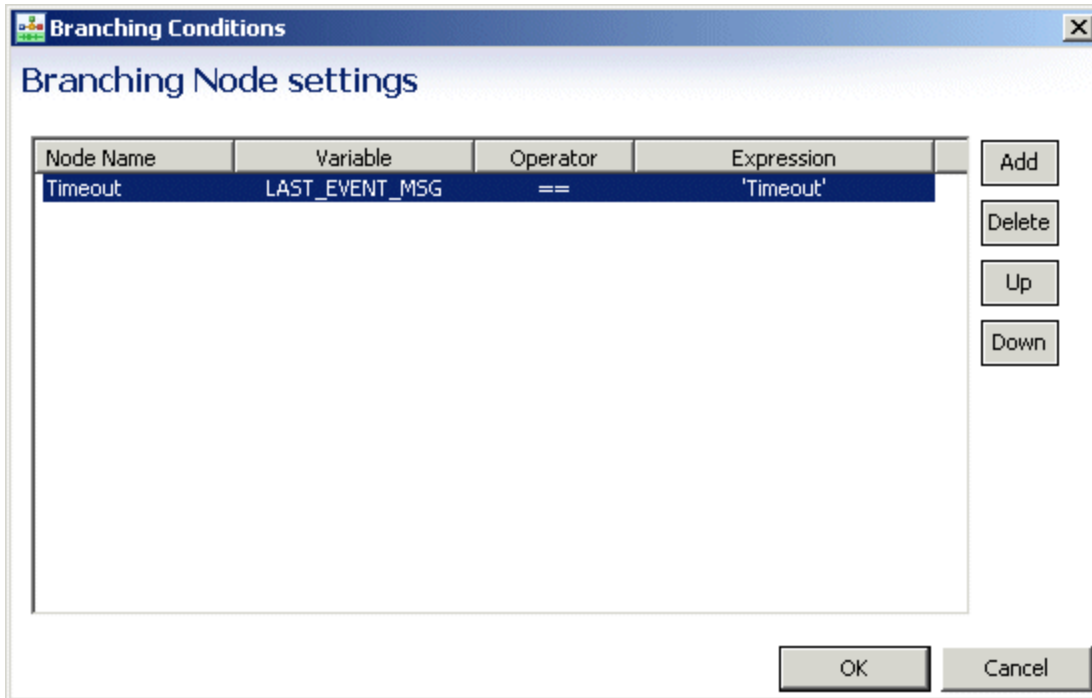

Unless special processing is required at the local level, it is best to handle events at the global level in the Main callflow.

Exception Event Descriptions

The table below names and describes Composer exception events for both callflows and workflows. For callflow VXML events, additional information on events can be found in the [GVP 8.1 Legacy Genesys VoiceXML 2.1 Reference Manual](#).

Exception Event Name	Description
all	This is a generic catch-all exception handler that will catch any exception not handled by the Entry block. It should be the last catch handler in the sequence of exceptions for a block.
cancel	The caller has requested to cancel playing of the current prompt. (Available when the Universals property includes Cancel.)
com.genesyslab.composer.toomanynoinputs	Occurs when the number of no inputs exceeds the maximum retries in Menu, Input, and Record blocks, and blocks do not have local noinput exception ports.
com.genesyslab.composer.toomanynomatches	Occurs when the number of no matches exceeds the maximum retries in Menu, Input, and Record blocks, and blocks do not have a local nomatch exception port.
com.genesyslab.externalmessage	For handling asynchronous external events.

	(Available when <code>com.genesyslab.externalevents.enable</code> is set to true.)
<code>connection.disconnect.hangup</code>	The caller hangs up. Applies at any time except during blind transfers.
<code>connection.disconnect.transfer</code>	The call was "blind transferred" to another line and will not return.
<code>error</code>	The platform encountered any error, such as <code>error.noresource</code> .
<code>error.badfetch</code>	A fetch of a resource failed due to semantic errors in the VoiceXML page.
<code>error.badfetch.badxmlpage</code>	The page that was fetched is an invalid XML page.
<code>error.badfetch.grammar.load</code>	The platform failed to load a grammar.
<code>error.badfetch.grammar.syntax</code>	A grammar has a syntax error.
<code>error.badfetch.grammar.uri</code>	The platform failed to fetch a grammar uri.
<code>error.badfetch.http</code>	A fetch of a resource failed, and the platform returned an HTTP Response failure code.
<code>error.com.genesyslab.composer.badfetch</code>	Bad request.
<code>error.com.genesyslab.composer.badgateway</code>	Bad gateway.
<code>error.com.genesyslab.composer.customernotfound</code>	Context Services Identify Customer Block, Suppress Customer Not Found Exception Property : If set to false (default), this exception is raised when no matching customer is found.
<code>error.com.genesyslab.composer.dbconnectionerror</code>	This error indicates that there was an error encountered while attempting to connect to the database.
<code>error.com.genesyslab.composer.dberror</code>	All database errors (other than <code>dbtimeout</code> and <code>dbconnectionerror</code>) result in this exception. The error text associated with this exception will contain the exact error returned by the database.
<code>error.com.genesyslab.composer.dbtimeout</code>	This error indicates that there was a timeout while waiting for query results to be received from the database. The timeout period is controlled by the <code>Timeout</code> property
<code>error.com.genesyslab.composer.dbemptyresultset</code>	This error indicates that the query or a stored procedure execution resulted in an empty result set, i.e., No records were returned. If the application will handle this condition and the exception is not required to be thrown then it can be suppressed using the Suppress Empty Result Set Exception property .
<code>error.com.genesyslab.composer.forbidden</code>	Forbidden plus specific error message from the server.
<code>error.com.genesyslab.composer.invalidkey</code>	This is the event error for handling an invalid key name. For example, the <code>userdata</code> key being accessed by the Interaction Data block is not a valid key.

error.com.genesyslab.com.composer.notauthorized	Not authorized.
error.com.genesyslab.com.composer.notfound	Not found.
error.com.genesyslab.composer.operationtimeout	This error occurs when the request for Userdata, AccessNumGet, or Statistics times out at the lserver.
error.com.genesyslab.composer.receiveerror	This error occurs when the lserver is down at the udata(getstat,AccessNumget) request.
error.com.genesyslab.composer.recordCapture.failure	Error occurred while saving the recorded file on the Web server side.
error.com.genesyslab.composer.servererror	This error occurs when there is an error in processing the request for the server side blocks such as "Invalid parameters" or "Web server is down." For Context Services blocks: Internal Server Error plus specific error message from the server.
error.com.genesyslab.composer.serviceunavailable	Service unavailable.
error.com.genesyslab.composer.webservice.batchfetch	For attribute descriptions, see the SCXML Language Reference
error.com.genesyslab.customernotfound	For attribute descriptions, see the SCXML Language Reference
error.com.genesyslab.composer.unsupported	This error occurs when the CTI applications designed for CTIC supported features like AccessNumget, Statistics, Interaction-Delete, Replace are called against a SIP Server environment.
error.com.genesyslab.subdialog.maxdepthexceeded	Error when subdialog depth limit is exceeded.
error.connection	This is the base exception for any connection-related error. For example, error.connection.protocol.nnn is thrown when the protocol stack for the connection raised an exception in the case of a bridged transfer. This error can be caught using this base exception.
error.connection.baddestination	The destination URI is malformed in the Transfer block.
error.connection.noauthorization	The caller is not allowed to call the destination, after initiating a transfer using the Transfer block.
error.connection.noresource	The platform could not allocate resources to place the call initiated by the Transfer block.
error.connection.noroute	The platform was not able to route the call to the destination, in a case where the destination URI (phone number) has the correct format.
error.dialog.collect	For attribute descriptions, see the SCXML Language Reference .
error.dialog.continue	For attribute descriptions, see the SCXML Language Reference .

error.dialog.createann	For attribute descriptions, see the SCXML Language Reference .
error.dialog.deleteann	For attribute descriptions, see the SCXML Language Reference .
error.dialog.play	This indicates that an error occurred while trying to perform the <play> request. For attribute descriptions, see the SCXML Language Reference .
error.dialog.playandcollect	This indicates that an error occurred while trying to perform the <playandcollect> request. For attribute descriptions, see the SCXML Language Reference .
error.dialog.playandverify	For attribute descriptions, see the SCXML Language Reference .
error.dialog.playsound	This indicates that an error occurred while trying to perform the <playsound> request. For attribute descriptions, see the SCXML Language Reference .
error.dialog.remote	For attribute descriptions, see the SCXML Language Reference .
error.dialog.setdialogdefaultdest	This indicates that an error occurred while trying to perform the <setdialogdefaultdest> request. For attribute descriptions, see the SCXML Language Reference .
error.dialog.start	This indicates that an abnormal condition occurred while trying to perform the start request. This event will be sent as a result of a timeout of the request as well as problems with the request itself. For attribute descriptions, see the SCXML Language Reference .
error.dialog.stop	This indicates that an error occurred while trying to perform the <stop> request. For attribute descriptions, see the SCXML Language Reference .
error.interaction.redirect	For attribute descriptions, see the SCXML Language Reference .
error.msgbased.createmessage	This event is sent when the <createmessage> request has failed for some reason.
error.msgbased.sendmessage	This event is sent when the <sendmessage> request has failed for some reason.
error.noresource	The specified language is not supported by the TTS/ASR server, or the TTS/ASR server/service is down.
error.noresource.recording	Occurs when MCP fails to start the GIR recording for any reason. For callflow VXML events, additional information on events can be found in the GVP 8.1 Legacy Genesys VoiceXML 2.1 Reference Manual .
error.queue.cancel	For attribute descriptions, see the SCXML Language Reference .

	Reference.
error.queue.default	For attribute descriptions, see the SCXML Language Reference.
error.queue.query	For attribute descriptions, see the SCXML Language Reference.
error.queue.start	For attribute descriptions, see the SCXML Language Reference.
error.queue.stop	For attribute descriptions, see the SCXML Language Reference.
error.queue.submit	<p>This indicates that an abnormal condition occurred while trying to perform the submit request. This event will be sent as a result of a timeout of the request as well as problems with the request or interaction itself.</p> <p>Busy treatment exceptions are raised as the error.queue.submit exception and not as exceptions listed in individual treatment blocks. See the routing application Target block for more information.</p>
error.queue.update	For attribute descriptions, see the SCXML Language Reference.
error.semantic	See the GVP 8.1 Legacy Genesys VoiceXML 2.1 Reference Manual.
error.session.fetch	An error occurred while trying to perform the fetch of a resource in a workflow.
error.session.start	For attribute descriptions, see the SCXML Language Reference.
error.session.terminate	For attribute descriptions, see the SCXML Language Reference.
error.unsupported	The platform encounters any error of type unsupported, such as error.unsupported.builtin.
error.unsupported.builtin	The built-in grammar is not supported by the platform or the ASR engine.
error.unsupported.format	An unsupported grammar format or audio format is encountered.
error.unsupported.language	The platform does not support the language for either speech synthesis or speech recognition.
error.unsupported.objectname	The requested object is not supported.
error.unsupported.receive	The application's access to messaging is disabled in MCP. This may be received as a VXML event for <receive> blocks.
error.unsupported.send	<p>The application's access to messaging is disabled in MCP. This may be received as a VXML event for <send> blocks.</p> <p>Note: This will be applicable to all blocks that use <send>, such as the Interaction Data block.</p>
error.unsupported.transfer	This is the base exception for any unsupported

	transfer settings.
error.unsupported.transfer.blind	The platform (configuration) does not support blind transfers, and the application specifies that it wants to do a blind transfer.
error.unsupported.transfer.consultation	The platform does not support consultative transfers, and the application specifies that it wants to do a consultative transfer.
error.unsupported.transrec.type	The platform does not support the media format.
error.unsupported.uri	The platform does not support the URI format (for example, fax://...).
exit	The caller has asked to exit. (Available when the universals property includes exit).
help	The caller has asked for help. (Available when the universals property includes help).
maxspeechevent	The caller input was too long, exceeding the property maxspeechevent.
noinput	The application expects voice or DTMF input, but it has received none from the caller within the timeout interval.
nomatch	The caller input something, but it was not recognized.

Exception Events for eServices UCS Blocks

The following eService blocks for Universal Contact Server use the exception events listed below:

- [Identify Customer](#)
- [Update Customer](#)
- [Create Customer](#)

See the individual block topics for the list of supported exceptions.

Exception Event Name	Error Code	Error Description
error.com.genesyslab.composer.badrequest	400	Bad Request.
error.com.genesyslab.composer.notfound	404	Not Found.
error.com.genesyslab.composer.servererror	500	Internal Server Error + specific error message from Composer.
error.com.genesyslab.composer.nocontent	405	No text found in standard response : <UCS error message>.
error.com.genesyslab.composer.missingparameter	201	Missing parameter name.
error.com.genesyslab.composer.incompatibleparameter	202	Parameter '1' and '2' are not allowed.
error.com.genesyslab.composer.invalidparametertype	203	Incorrect type for parameter

		<parameter_name>, expected type 1 but was type 2.
error.com.genesyslab.composer.invalidparametervalue	204	Incorrect value for parameter <parameter_name>, expected value 1 but was value 2.
error.com.genesyslab.composer.invalidmessagetype	502	Invalid third party message type.
error.com.genesyslab.composer.objectnotfound	510	Object not found in database.
error.com.genesyslab.composer.incorrectsubtype	512	Incorrect subtype for interaction <interaction_name>, expected type 1 but was type 2.
error.com.genesyslab.composer.servererror	704	Unexpected error exception message.
error.com.genesyslab.composer.database	710	Connection to database failed.
error.com.genesyslab.composer.serveroverloaded	716	Server overloaded, request rejected.
error.com.genesyslab.composer.noattributes	730	No searchable attribute.
error.com.genesyslab.composer.invalidtenant	732	Invalid Tenant <tenant_name>.

Expression Builder

Use for both voice callflows and routing workflows to build expressions for branching and conditional routing decisions. You create an expressions in Expression Builder by:

- Selecting the function, variable, or JavaScript in the right pane and editing in the left pane.
- Manually creating expressions in the top left pane.
- Optionally using **ECMAScript** expressions that can use the **Genesys SCXML engine** and/or **Orchestration Extensions**.
- Assigning expressions to **variables** using various blocks.

Important

Any functions not listed in the Expression Builder must not be used as they are internal functions and may change in the future without notice.

Also see **Skill Expression Builder** used for routing applications.

Opening Expression Builder

Expression Builder opens from the many blocks, which include but are not limited to:

- Assign--**Assign Data Property**
- Branching--**Conditions Property**
- ECMAScript (for workflows)--**Script Property**
- Entry--**Variables Property**
- Log--**Logging Details Property**
- Looping--**Exit Expression Property**

Data Categories Accessed

The right pane contains the following categories of data:

- **Project Variables**
- **Workflow Variables** (if accessed from a workflow)
- **Callflow Variables** (if accessed from a callflow)

- [Workflow Functions](#) (if accessed from a workflow)
- [Callflow Functions](#) (if accessed from a callflow)
- JavaScript (Array, Boolean, Date, Math, Number, String functions)
- [Orchestration Server Functions](#)
- [Context Services](#)
- [Configuration Server](#)

Note: Depending on the calling context (IPD, workflow editing, callflow editing), some of the above categories may be hidden.

Expression Builder Toolbars

This section discusses the editing toolbar the top of Expression Builder as well as supported [Operators](#).

Editing Toolbar

Expression Builder has an editing toolbar with buttons representing copy, cut, paste, delete, undo, redo, and validate . After you entering an expression and click the button to validate, syntax messages appear under the Expression Builder title. In the figure below, the syntax message is: No syntax error was found.

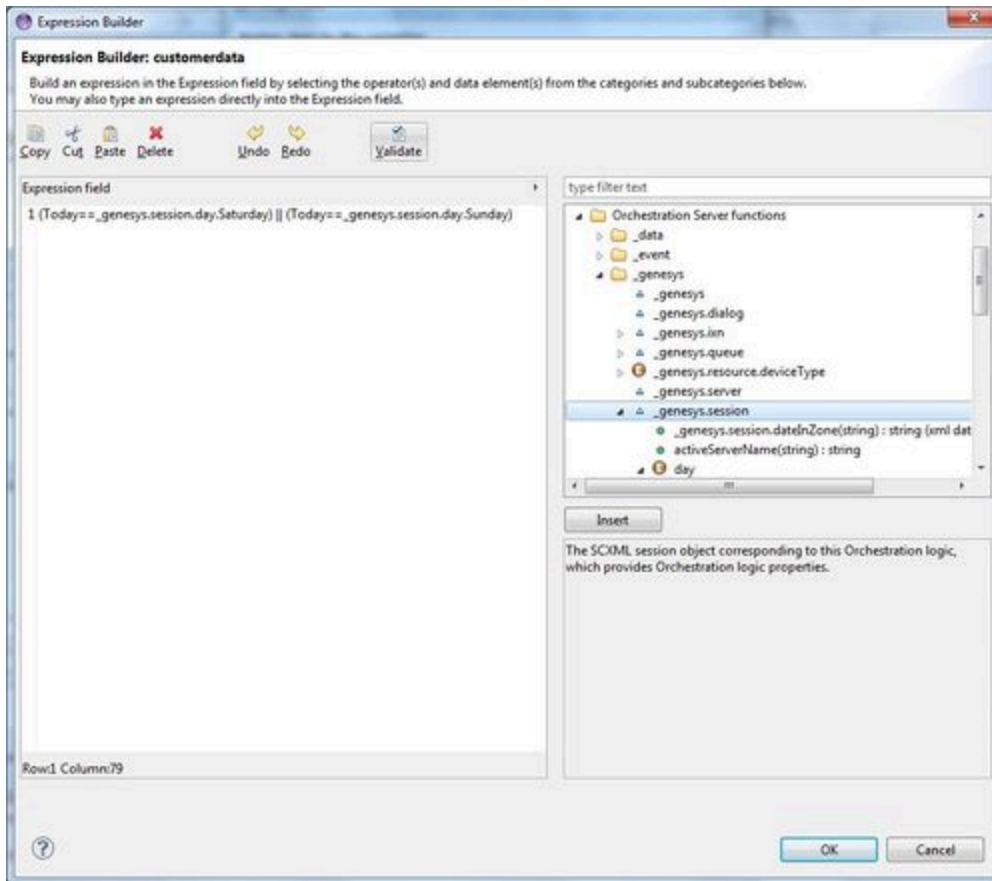

Operators

Expressions can consist of comparisons joined by AND (&) and OR (|), which have the same priority. URS uses integer arithmetic in its calculations, such as for expression evaluation. For this reason, you must always create expressions based on integer arithmetic, not float. When an expression contains more than one logical comparison, the logical operation to the left has precedence over the operation to the right. Use parentheses to overrule this precedence. When the order of logical operations is not explicitly specified by parentheses, the operation to the left has precedence over the operation to the right. For example: Portuguese > 5 | Africa = 7 & SpTours >3 is equivalent to (Portuguese > 5 | Africa = 7) & SpTours > 3 Each comparison consists of two data values that are compared against each other. The table below shows the operators used in logical expressions.

Symbol	Meaning	Example
==	use for comparison (e.g. x==y to compare is x equal to y)	see example screen shot
=	equal to done for assignment (e.g. x=y to assign x equal to y)	Day = Monday
!=	not equal to	Day != Sunday

&	Single & is an AND operators which manipulates internal bits of integers	
&&	&& and are used for comparisons to build boolean (true/false) expressions	
	see &&	see example screen shot
>	greater than	Time > 9:00
>=	greater than or equal to	Day >= Monday
<	less than	Time < 16:00
<=	less than or equal to	Day <= Friday

Mathematical Symbols Allowed

The allowed mathematical symbols in expressions are restricted to those symbols for addition, subtraction, division, and multiplication (+, -, /, *). These symbols work with numeric values only, so any participating String argument is automatically converted to a number.

Examples of Expressions

The table below shows example expressions.

Example	Interpretation
Day=Saturday Day=Sunday	If the day is Saturday or Sunday
Time<=5:00 Time>=18:00	If the time is less than or equal to 5:00 (5:00 AM) or greater than or equal to 18:00 (6:00 PM); in other words, if the time is between 6:00 PM and 5:00 AM.
Day>=Monday&Day<=Friday & ANI!=8004154732	If the day is a weekday and the ANI is not 8004154732
SData[1123@SF.A,StatTimeInReadyState]>120	If agent 1123 has been in Ready state for more than 120 seconds
UData[Acct]>=9000	If the value associated with the key Acct in the Interaction data structure is equal to or greater than 9000

Creating Expressions

Note: Expressions entered in the Expression Builder could be used directly as a value for an attribute, hence single quotes are recommended.

Assume you wish to create the expression shown in the Expression field below.

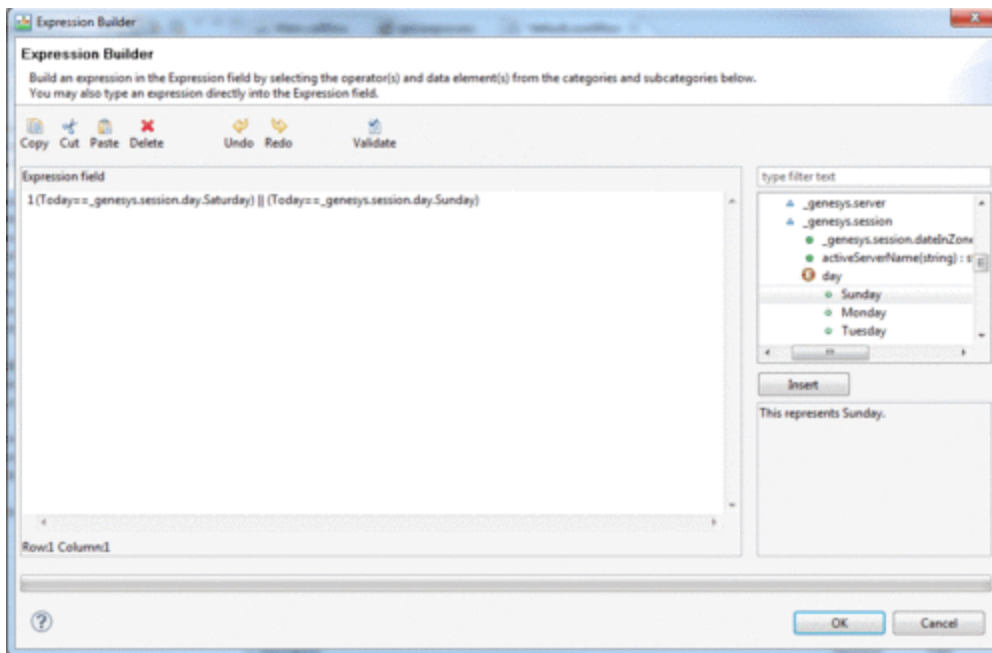

In the above figure, the expression `(Today ==_genesys.session.day.Saturday) || (Today ==_genesys.session.day.Sunday)` was created as follows:

- In the left text field under the toolbar, type an open parenthesis (`()`).
- If you already defined the "Today" variable, select it under **Workflow variables** or **Project variables**. Otherwise, if not yet defined, type "Today" (no quotes) in the text after the open parenthesis.
- Type "==" (no quotes) in the text.
- In the right text box, expand:

Orchestration Server Functions `_genesys genesys.session.day`

- Double-click **Saturday**.
- In the left text field, type a close parenthesis (`()`)
- Click the **|| Operators** button. Repeat the above steps except, at the end before the close parenthesis, select `_genesys.session.day.Sunday`.

Note: You may also use the search field on the right side to filter items that include **Saturday**

Usage of Variables in Expressions

Note: The steps for using variables in Expression Builder varies slightly depends on whether you are creating a voice callflow or a routing workflow.

- If creating a voice callflow, the right selection area contains Callflow Variables.
- If creating a routing workflow, the selection area contains Workflow Variables.

Using Variables in a Callflow

Assume you wish to use **variables** in a callflow to create the following:

AppState.goldFixInUSDAppState.ConversionRateResponseAppState.ConversionRateResult The figure below shows the entry in Expression Builder.

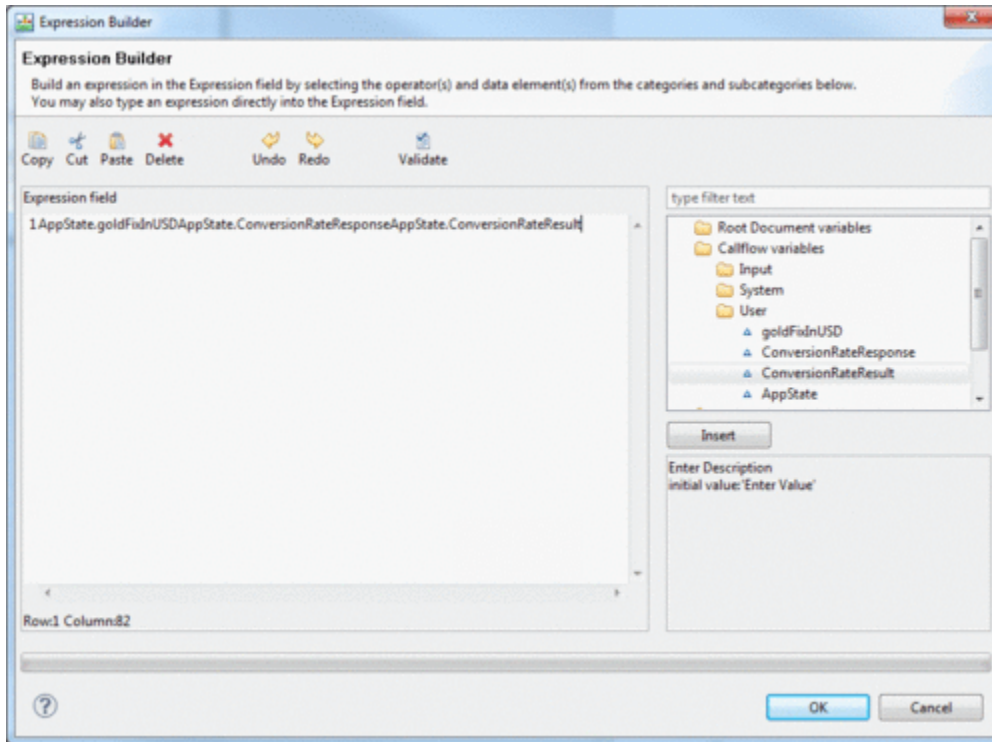

Assume you have already defined these variables in the Entry object. The above entry could then be created as follows:

1. The right selection area lists **Callflow Variables**, **Java Script**, and **Context Services**.
2. Expand **Callflow Variables**#Expand **User** to view variables defined in the **Entry block**.
3. To place the variables in the Expression field at the top of Expression Builder, double-click **goldFixInUSD**, **ConversionRateResponse**, and **ConversionRateResult**. The AppState VoiceXML Data Model Object will be appended automatically to variables used inside Expression Builder. The code inside the Expression field will be directly substituted within the generated VoiceXML code.
4. Continue creating the expression.

Expression Builder Data Categories

Expression Builder accesses various categories of data Including Orchestration Server and Universal Routing Server functions. The folders shown on the right depend on whether you are working with a callflow or workflow. The figure below shows Expression Builder Data Categories when working with a

workflow.

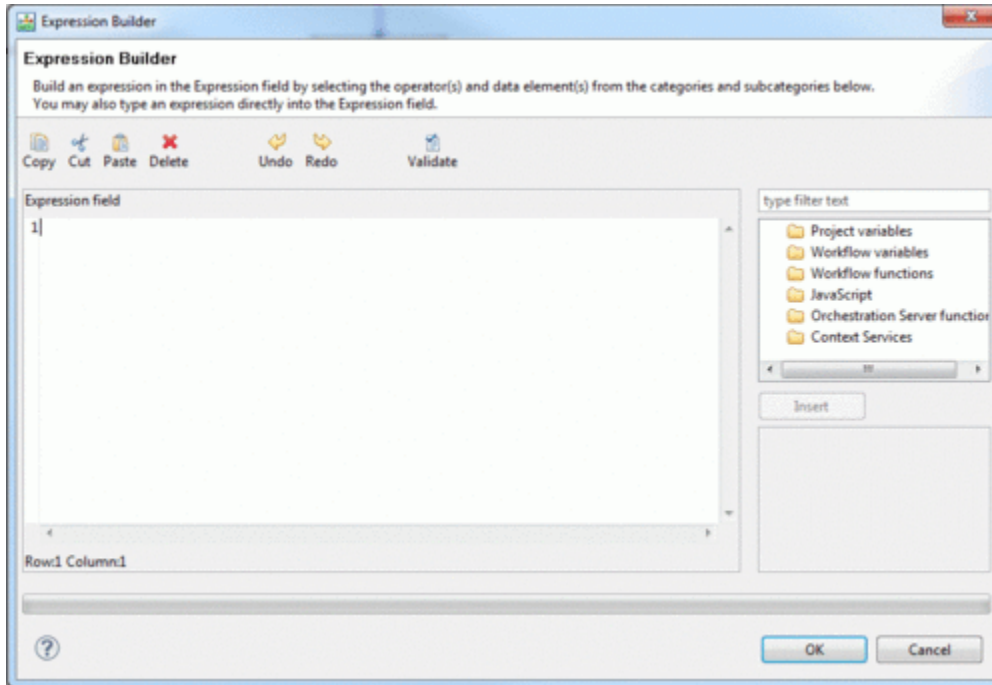

Project variables

Use **Project variables** when you need to share information across different workflows.

Workflow variables

Use **Workflow variables** when you need to share information across different blocks in the same workflow.

Workflow functions

Use the Workflow functions category when creating routing workflows. Selecting a function displays a description. For example, selecting `deCodeBinary(array) : string` (available starting with 8.1.410.14) displays the function description underneath.

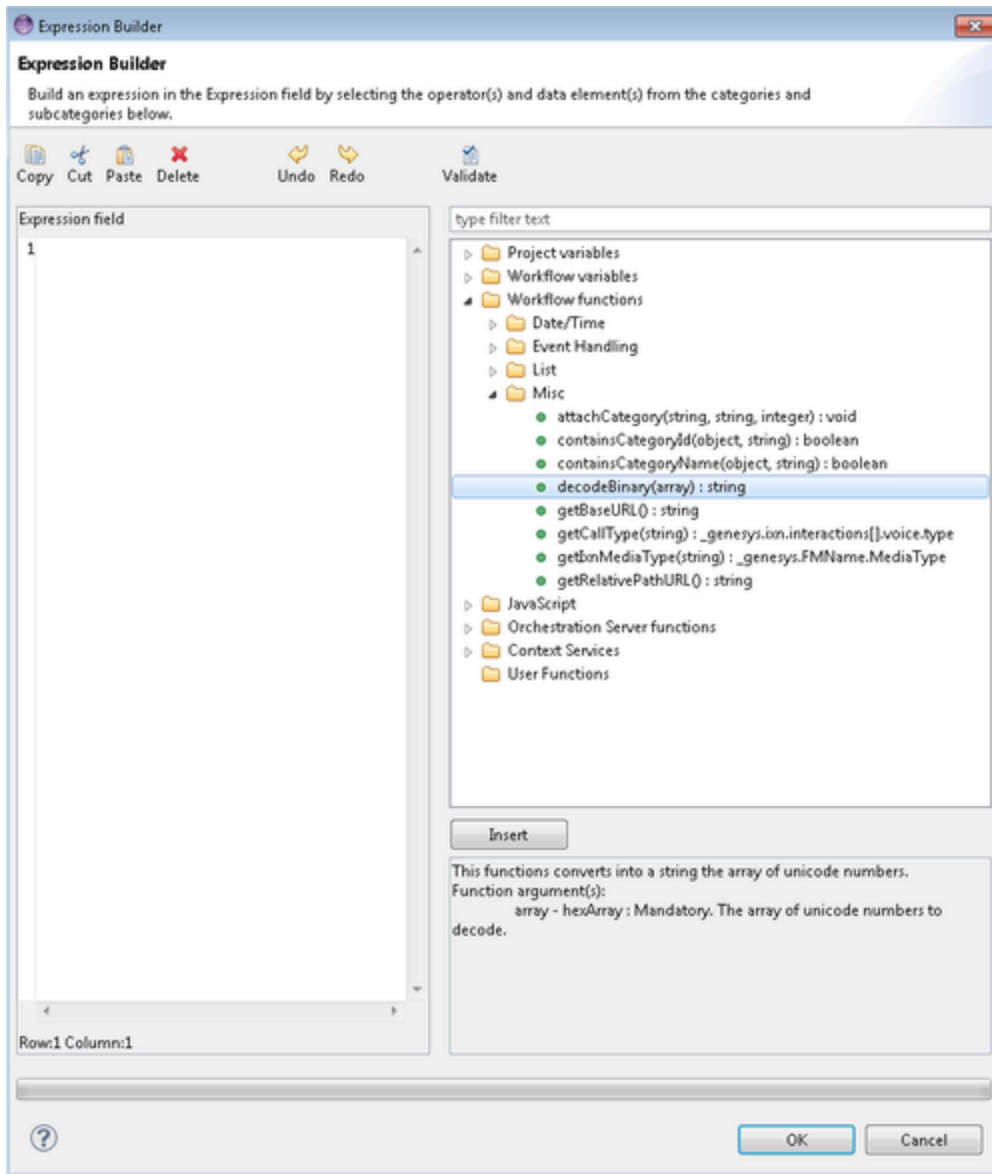

See the [Orchestration Server wiki](#) for information on functions available for use in Composer when building routing workflows. **Notes:** Functions `getCallType` and `getIxnMediaType` can be used to identify the call type and/or media type for the purpose of segmenting incoming interactions.

- `getCallType(ixnID)`--This function gets the call type `_genesys.ixn.interactions[].voice.type` for the specified interaction. If the `ixnID` is not specified, it will return the calltype for the current interaction.
- `getIxnMediaType(ixnID)`--This function gets the correct media type ENUM from `_genesys.FMName.MediaType` for the specified `ixnID`. If `ixnID` is not specified, the current interaction id will be used. If the interaction's media type cannot be determined or the specified `ixnID` does not exist, the function will return undefined.

Use Case: A call arrives on a routing pointing, initiating a routing workflow. The workflow checks for the call type. If the call type is outbound, then the call is immediately moved to the front of the queue and routed to an available agent. If the call type is inbound, the call is assigned a priority and routed based on the desired service level. For information on the other functions, see [eServices Blocks](#).

Callflow functions

Note: Function `getSIPHeaderValue(headername)` returns the SIP header value associated with the given SIP headername. You may wish to use this function with the [Assign block](#).

JavaScript

Use JavaScript to access those functions categorized as follows: Array, Boolean, Date, Math, Number, String.

Context Services

Use Context Services when creating expressions that use attributes associated with this optional capability of Universal Contact Server Database.

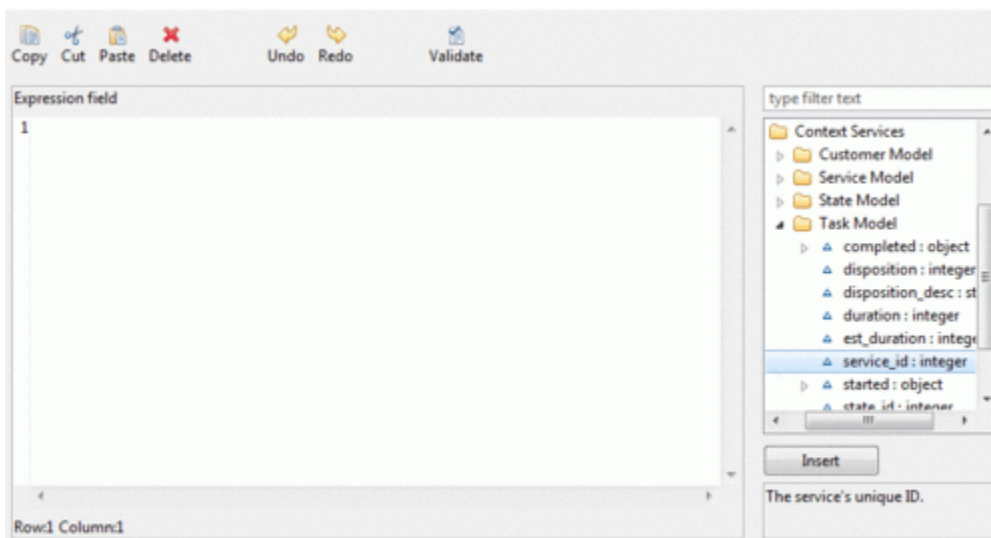

Configuration Server

This category is displayed for workflows when the Expression Builder is called from the [ECMAScript](#) and [Branching](#) blocks. If [connected to Configuration Server](#), Composer can fetch standard responses and category codes.

Standard Response Library

This category allows you to access pre-written responses for customers that have been defined in

Knowledge Manager (as described in the *eServices 8.1 User's Guide*).

Orchestration Server and URS Functions

Composer's Expression Builder provides access to many Orchestration Server and Universal Routing Server (URS) functions. For more information see [Using URS Functions](#).

Threshold Functions

Universal Routing Server's threshold functions can be used for conditional routing. For example, the threshold functions can be used in the **Target block** for a type of conditional routing called "share agents by service level agreement routing." This type of routing enables a business user that manages multiple business lines to define the triggering conditions and constraints that allow agents to be shared among business lines. By constructing a single threshold expression, you can define the triggering conditions for borrowing agents from other business lines as well as the conditions that apply to the lending business line.

Threshold is an analog of the URS strategy function SetTargetThreshold as defined in *Universal Routing 8.1 Routing Application Configuration Guide*. It defines additional conditions the target must meet to be considered as valid target for routing. The threshold functions are available in Composer's Expression Builder:

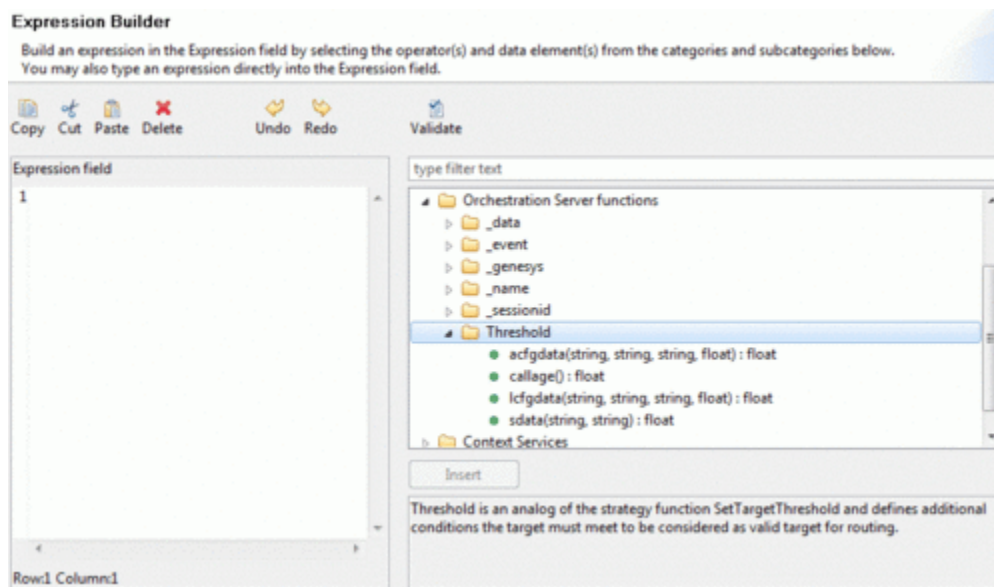

- `acfgdata(Application name, folder, property, default value)`. Use this function to affect routing conditions based on external data stored in properties of Configuration Database Application objects (ApplicationConFigDATA). Returns a numeric value for a specified Application option. If an Application has no such option then the default value is returned. Return value type: FLOAT. Example: `sdata(Group2.GA, StatAgentsAvailable)>acfgdata(URS, default, MinNumOfRdyAgents, 2)`

- `callage`. Use this function to return the age of an interaction in seconds. Use for time-based routing conditions, such as a call that can only be routed if it waits more than 60 seconds. Return value type: FLOAT.
- `lcfgdata(list name, item, attribute, default value)`. Use this function to affect routing conditions based on external data stored in [List objects](#). Returns a numeric value for a specified attribute of a List object's item. If a List object has no such item or attribute, the default value is returned. Works like `acfgdata`, but uses a List object (`ListConFigDATA`) instead of an Application. Return value type: FLOAT.
- `sdata(target, statistic)`. Use this function to affect routing conditions based on statistics. Specify targets and statistics just like for the `SData[]` function described in the *Universal Routing 8.1 Reference Manual*. You can use the URS predefined statistics (see [Statistics Manager and Builder](#)), such as: `PositionInQueue`, `CallsWaiting`, and `InVQWaitTime`. Return value type: FLOAT. Example:
`sdata(Group2.GA, StatAgentsAvailable)>2`

Example Threshold Expression

A threshold expression is text string very similar to the regular expressions used for branching, but uses the threshold functions. In the example below, `sdata` and `lcfgdata` are the predefined threshold functions.

```
sdata[VQ_VISA.Q, StatCallsInQueue]>30 &lcfgdata[CreditCards, VISA, stolen, 0]> 200 &
sdata[VQ_MC.Q, StatCallsInQueue]=0 & sdata[MC5.GA., StatAgentsAvailable]>=2
```

In this example, both the borrowing and lending conditions are defined in a single threshold expression:

Borrowing Triggering Conditions for VisaCard

- If the VisaCard queue has more than 30 voice calls waiting in virtual queue and
- If the number of stolen card in VisaCard system exceeds 200.

```
sdata[VQ_VISA.Q, StatCallsInQueue]>30 &lcfgdata[CreditCards, VISA, stolen, 0]> 200 &
sdata[VQ_MC.Q, StatCallsInQueue]=0 & sdata[MC5.GA., StatAgentsAvailable]>=2
```

Lending Triggering Conditions for MasterCard

- If the MasterCard queue has 0 calls waiting and
- 2 agents with skill MasterCard level ≥ 5 with an available voice channel.

For detailed information on using the threshold functions, see [Universal Routing 8.1 Routing Application Configuration Guide](#) and threshold attribute in the [Orchestration 8.1.3 Developers Guide.Queue_Interface#Attribute_Details](#)

GetMediaTypeName Function

This function returns the name of media type associated with interaction as defined in the Configuration Database. Located in Expression Builder as follows: `_genesys.ixn.mediaType`. Expression Builder lists the Media type enumerators supported by the URS platform. The main difference between this function and IRD's `getMediaTypeName` function is that

- The IRD function takes a parameter for (the current interaction media type) and returns a String name of the media type

Whereas:

- Composer's function `getIxnMediaType(ixnID)` takes a parameter of any interaction and returns a ENUM type `_genesys.FMName.MediaType` of the media type. Returns the media type of the given interaction (`ixnID`), otherwise the current interaction.

User defined JavaScript Functions

Expression Builder shows the user defined JS methods under 'User Functions' category to list user defined JS methods for easy access.

- For Callflow diagrams, JavaScript files added in the Scripts property of the Entry BlockScripts are considered.
- For Workflow diagrams, JavaScript files added inside the include/user folder are considered.

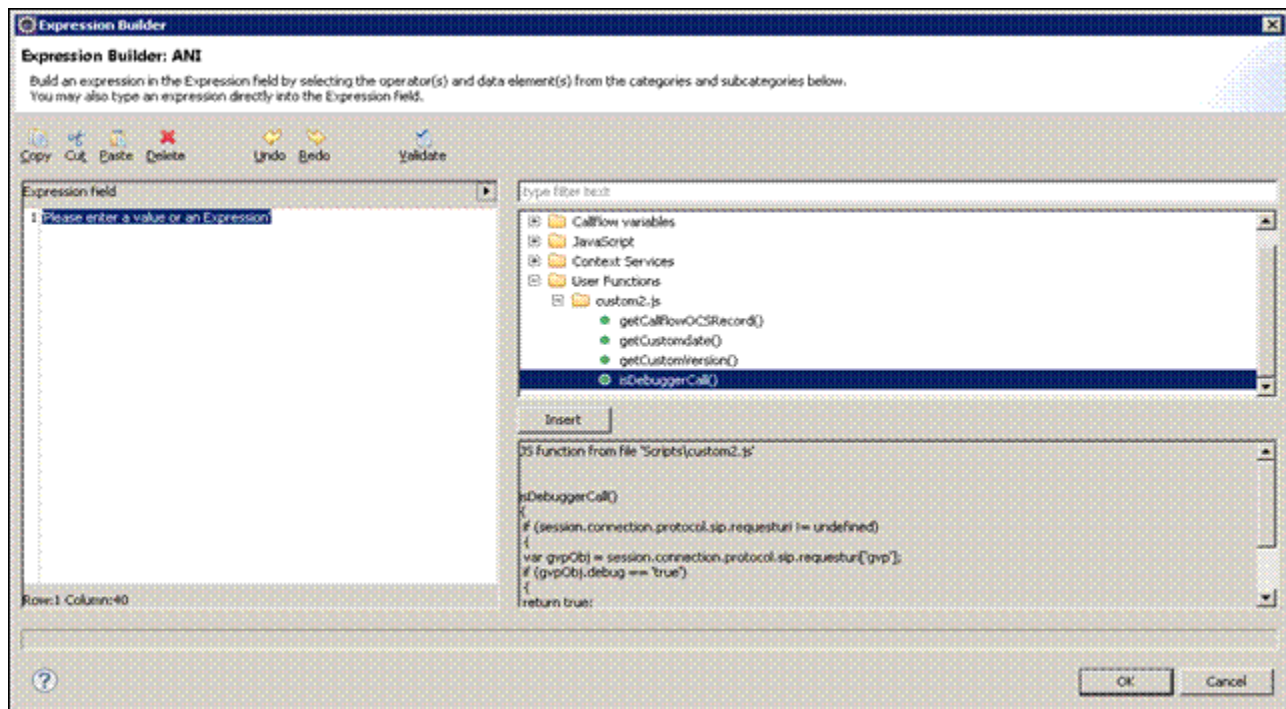

GAX Server Preferences

See [GAX Server Preferences](#) for voice applications.

Getting Using Email Addresses

This topic describes several ways to get the e-mail address of a customer using Context Services blocks and using it in the To property of the **Create Email** block.

Getting a Customer Email Address

There are two ways to get a customer's e-mail address from the Context Services server:

- Use the **Query Customer** block. If the Customer ID is unknown, first follow steps 1 and 2 below. Then, follow the steps 3 and 4.
- Use the **Identify Customer** block. Follow step 1 and set the property Get Attributes to Yes. Then follow step 4 and change the ECMAScript expression to `_data.EmailAddress=_data.CustomerData[0].EmailAddress`

Identifying a Customer

1. **Identifying a Customer.** A customer ID is necessary to use the Query Customer block. If the customer ID is unknown, you may use the Identify Customer block to get the Customer ID. In the example below, we are trying to identify a customer by the last name. The result of the request is stored in the CustomerData variable.

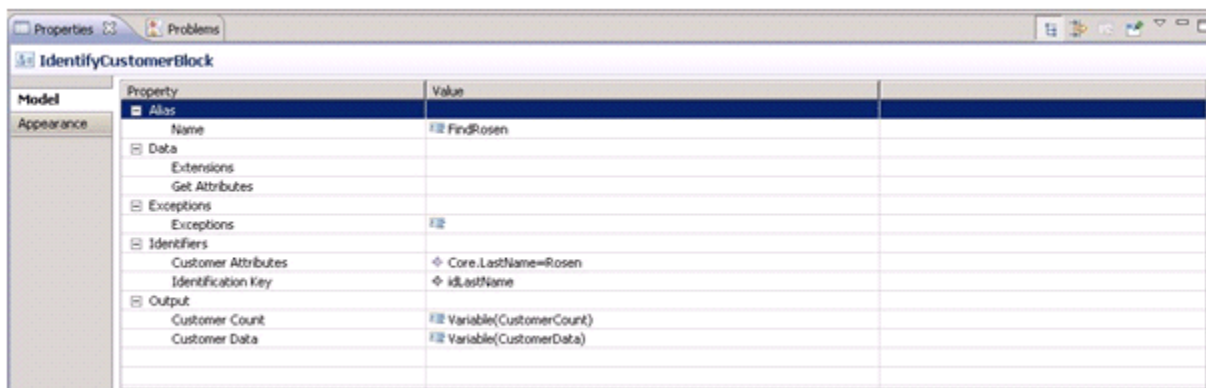

2. **Getting the Customer ID.** An ECMAScript block is used to extract the Customer ID after identifying the customer. The variable CustomerID is used.

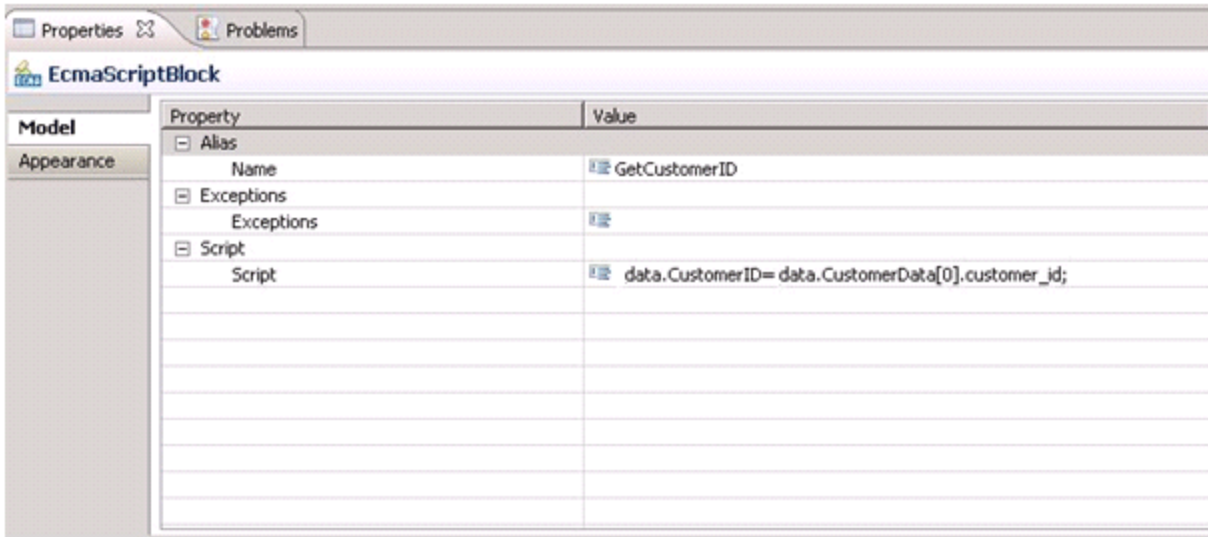

3. **Querying the customer profile.** The CustomerID variable is used in a Query Customer block. The result (JSON) is put in the CustomerData variable.

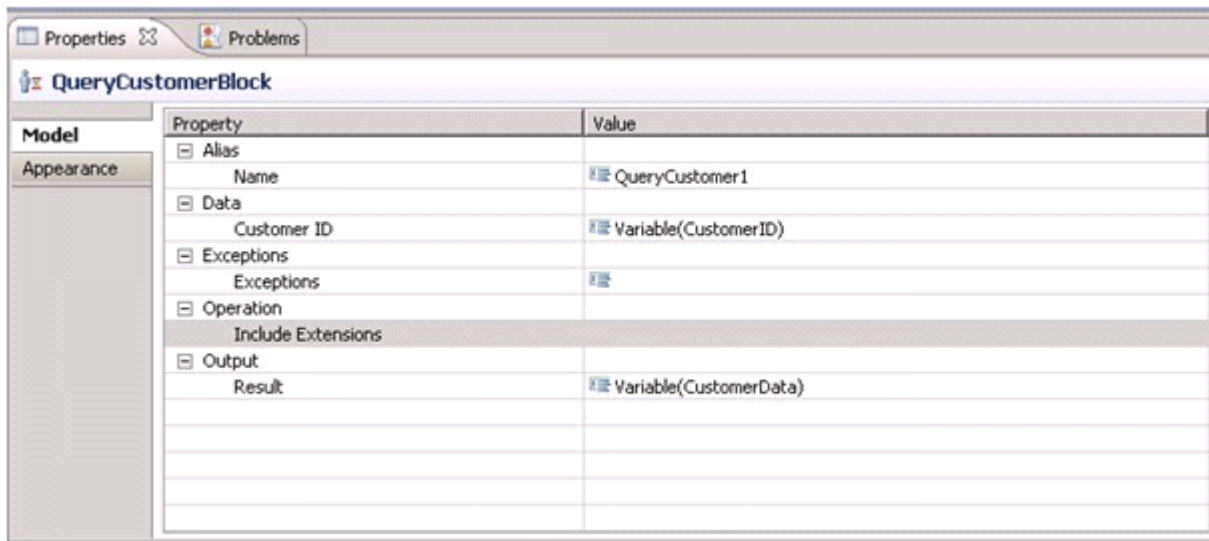

With the default Context Services schema, EmailAddress is a field of the customer profile. The CustomerData content sample:

```
{"EmailAddress": "Roger.Rosen@genesyslab.com", "FirstName": "Roger", "PhoneNumber": ["+1.219.12345678  
Rosen ", "customer_id": "00001a5GD0A80040"}
```

4. **Extracting the e-mail address field.** You can then use a simple expression in an ECMAScript block to extract the e-mail address. The example below illustrates how to use Expression Builder to extract the e-mail address from the Core customer profile when using the default Context Services schema.

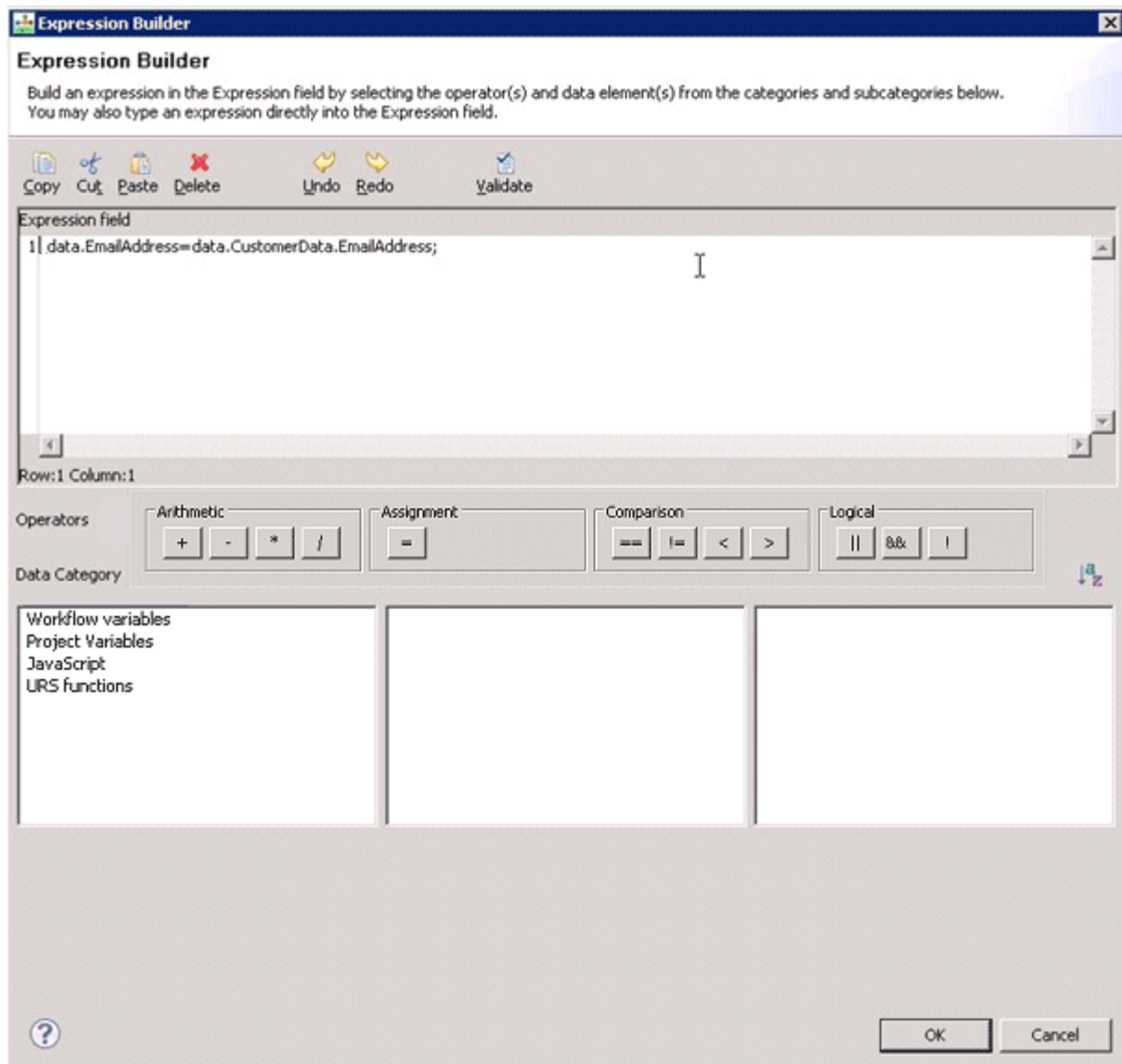

Using the E-mail Address in the To Field

In the Create Email block, when defining the **To** property, select the **Type** as Variable and select the variable that was previously used to save the e-mail address (`data.EmailAddress`) from above.

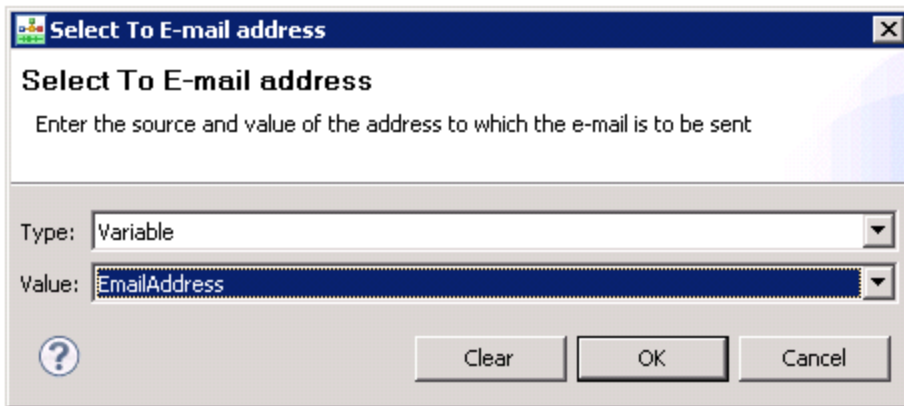

Using Variables Mapping for E-mail Addresses

With the **Variables Mapping** feature, getting an e-mail address is easy. When Customer ID is unknown:

- Set the Identify Customer/**Get Attributes** property to "Yes"
- Set the Identify Customer/**Variables Mapping** property to map the variable "EmailAddress" to the Context Services attribute "EmailAddress"

When Customer ID is known:

- Set the Query Customer/Variables Mapping property to map the variable "EmailAddress" to the Context Services attribute "EmailAddress"

No additional ECMAScript block is needed. The "EmailAddress" variable will automatically be assigned the customer's email address.

Import and Export

Composer provides several import options as described in this topic.

Importing External Files into Your Composer Project

If you have files, such as pre-recorded audio prompts for your application, that you would like to add to a Composer Project, you can add the files to the appropriate folder (such as the Resources\Prompts\en-US folder for audio prompt files) by dragging and dropping the files from Windows Explorer. Or, you can use the Composer Import function as follows:

1. Select File > Import, expand the General folder, then select File System and click Next.
2. In the Import File System dialog box, click the From directory Browse button to navigate to the folder that contains your audio prompt files.
3. Select the files and folders to import.
4. Click the Into folder Browse button and navigate to the location within an existing Composer Project (preferably within the Resources folder) where the files will be stored.
5. If you know you want to overwrite the resources in the selected folder, select the Overwrite existing resources without warning check box.
6. Select either Create complete folder structure or Create selected folders only as your situation dictates.
7. Click Finish to launch the import.

Use the Resource Type in the Prompt Settings dialog box of your Prompt block to add an audio file into the actual prompts of your application.

Importing Composer Projects into Your Workspace

Eclipse provides import and export options for copying Projects. Use the Import Wizard to copy the Composer Project from any other location into your workspace.

1. Select File > Import, expand the General folder, then select Existing Projects into Workspace and click Next.
2. Specify the path of the location from where you want to import the Project.
3. All Projects in the workspace will be shown in the Projects list. Select the ones that you wish to copy. Select the check box at the bottom to copy the files into your current workspace.
4. Click Finish to import the Composer Project.

Importing a CallFlow or Workflow Diagram Template

Diagrams saved as templates can be imported from the file system. See [Diagram Templates](#) for more information.

Exporting Application Prompts

You can export all the prompts from your Composer Project as XML or CSV files. This is very useful when sending the voice scripts to a Recording Studio where audio files would be recorded. Developers can also make good use of this feature for doing a quick review and sanity check of all application prompts.

1. Select File > Export, expand the Composer folder, then select Export Prompts Listing and click Next.
2. Select the Composer Project whose prompts you wish to export, the format for the export (XML or CSV), and the destination location. A file with the same name as the name of your Composer Project will be created in the destination location. The file extension will depend upon the format of the export selected.
3. Click Finish to begin the export.

Exporting a Composer Project as a WAR File

Exporting a Composer Project as a .war file is the first required step to deploy the voice application on your Production Web Application Server. Therefore, this subject is covered under [Deploying Voice Applications](#). Note: When you export a Project to a .war file, SQL files are not generated from [DB Data](#) blocks. Generate code once before exporting a project. Note: The following folders are not needed after export:

- simulation
- Callflows
- Debugging-results

Exporting Composer Projects to an Archive File

To export to an archive:

1. Select File > Export, expand the General folder, then select Archive File and click Next.
 2. Select the Composer Project(s) to save as an archive.
 3. Navigate to a destination for the archive file.
 4. Under Options, save as a .zip or .tar file, create a directory structure or only selected directories, and decide whether to compress the contents of the archive file.
-

5. Click Finish to begin the export.

Note: The following folders are not needed after export:

- simulation
- Callflows
- Debugging-results

Diagrams saved as templates can be exported to another user's Composer. See [Exporting a Diagram Template to the File System](#) for more information. When a Project is exported, Composer creates an entry in its logs. You can find the log file in: <workspace folder>\.metadata\log This location is fixed. You cannot move the log file to another location.

Application Reporting

Composer applications can generate reports that can be displayed in the [Reporting Server](#). You need the Reporting Server to be installed in your GVP setup to get application reports. The [Reporting blocks](#) can be used to send IVR-related reports from Composer-generated applications. To enable application reporting, use the [EnableReports variable](#). Use the VAR Call Browser in Genesys Administrator to access the reported data that is generated by the Reporting blocks when EnableReports is set to true. Note: Refer to Reporting Server and Genesys Administrator documentation for more details on Voice Application Reporting concepts.

Importing and Exporting Diagram Templates

Diagrams saved as templates can be exported to/imported from the file system. See [Using Diagrams as Templates](#) for more information.

Link Tool

The figure below shows examples of using the link tools:

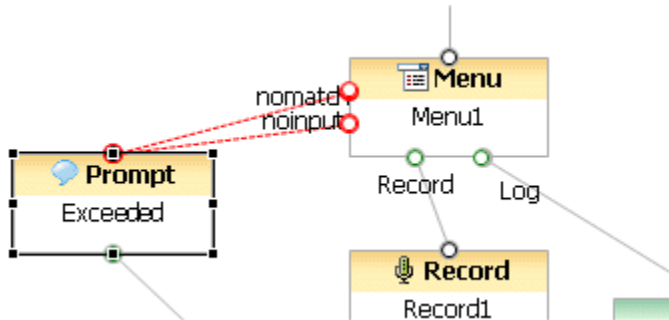

In the above example, the red links (going from the Menu block to the Prompt block) result from using the Exception Link tool to connect the two blocks. The black links (going from the Menu block to the Record block and the Log link) result from using the Outlink tool.

Link Tools Detail

The table below contains detailed information on the tools used for connecting blocks.

OutLink

Use the Outlink tool to connect blocks by selecting the tool and dragging from the source block to a target block. You can also connect blocks without using the Outlink tool. Simply start the drag operation from the source block's outport and drop into the target block. In both cases, the link can be dropped on top of the target block or to the connection port of the target block.

ExceptionLink

Use the Exception link tool for exception handling. When you define exceptions for a block in the dialog box that opens from the Properties tab, this creates the same number of exception ports on the block. Use to draw connections from an **exception port** to a another block.

Locales

A *locale* defines a language and region identifier that you want to work with. Composer lets you define default, active, and custom locales during Project creation or through the Project properties. The locales defined in each Composer project can be used in callflow diagrams, workflow diagrams, and **Grammar Builder**. When using Grammar Builder, you specify locales, which are the languages that a grammar file will support. The Grammar builder wizard uses the active locales for the Composer Project. Callflow diagrams use the default locale selection for the following **Entry block variables**:

- APP_LANGUAGE
- ASR_LANGUAGE

Workflow diagrams use the default locale selection for the following Entry block variable:

- system.Language.
- For additional local settings, see the figure in topic **Project Properties dialog box**.

Changing Locales at the Project Level

The Project locales may be changed at the Project Properties at any time.

1. In the Project Explorer, right-click the Composer Project and select **Properties**.
2. Select the **Locales** section.
3. Enable the check boxes to set active locales for the Project.
4. Select **Set as Default**.
5. You can also select existing diagrams to update with the default language locale.

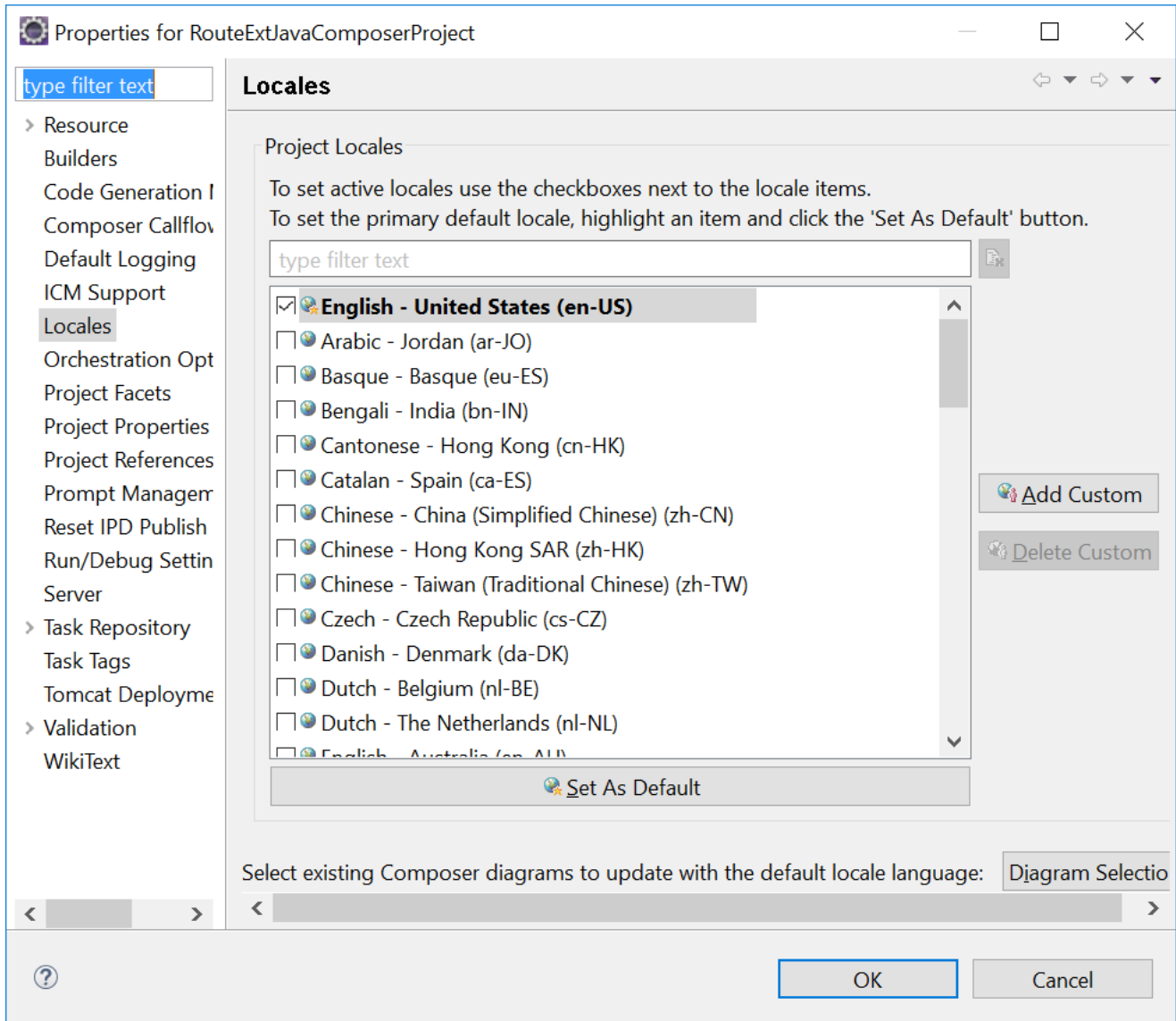

Changing the Default Locale

To set the default locale, highlight the row in the Project Locales list and click **Set as Default**. Any new callflows or workflows will inherit this new default locale. You may optionally update existing callflow and workflow Entry block language variables to the desired default language. The callflow/workflow language variables (APP_LANGUAGE and ASR_APP_LANGUAGE/system.Language) will be updated.

1. After selecting the default locale language, select the box **Select existing Composer diagrams with the default locale language**.
2. Click **OK**. The Diagram Locale Update dialog box opens.

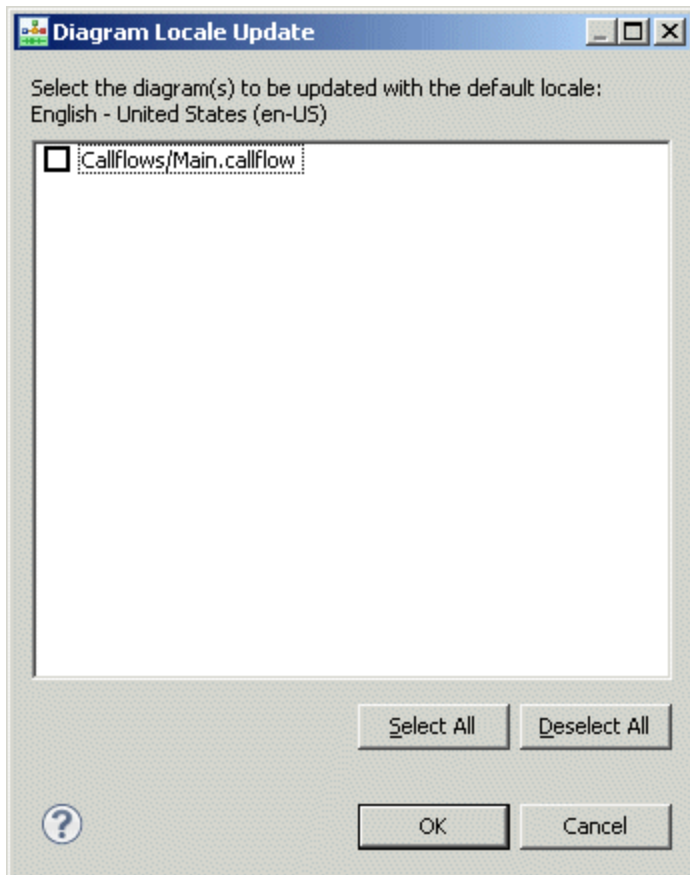

3. Select the diagrams to be updated with the default locale language.
4. Click **OK**.

Locales Supported

The Locales dialog box lists the following locales for selection:

English - United States (en-US)

Arabic - Jordan (ar-JO)
 Basque - Basque (eu-ES)
 Bengali - India (bn-IN)
 Cantonese - Hong Kong (cn-HK)
 Catalan - Spain (ca-ES)
 Chinese - China (Simplified Chinese) (zh-CN)
 Chinese - Hong Kong SAR (zh-HK)
 Chinese - Taiwan (Traditional Chinese) (zh-TW)
 Czech - Czech Republic (cs-CZ)
 Danish - Denmark (da-DK)
 Dutch - Belgium (nl-BE)
 Dutch - The Netherlands (nl-NL)
 English - Australia (en-AU)
 English - India (en-IN)
 English - Ireland (en-IE)
 English - Scotland (en-SC)
 English - South Africa (en-ZA)
 English - United Kingdom (en-GB)
 Finnish - Finland (fi-FI)
 French - Belgium (fr-BE)
 French - Canada (fr-CA)
 French - France (fr-FR)
 German - Austria (de-AT)
 German - Germany (de-DE)
 German - Switzerland (de-CH)
 Greek - Greece (el-GR)
 Gujarati - India (gu-IN)
 Hebrew - Israel (he-IL)
 Hindi - India (hi-IN)
 Hungarian - Hungary (hu-HU)
 Icelandic - Iceland (is-IS)
 Italian - Italy (it-IT)
 Japanese - Japan (ja-JP)
 Kannada - India (kn-IN)
 Korean - Korea (ko-KR)
 Malayalam - India (ml-IN)
 Marathi - India (mr-IN)
 Norwegian (Nynorsk) - Norway (nn-NO)
 Norwegian - Norway (no-NO)
 Oriya - India (or-IN)
 Polish - Poland (pl-PL)
 Portuguese - Brazil (pt-BR)
 Portuguese - Portugal (pt-PT)
 Punjabi - India (pa-IN)
 Russian - Russia (ru-RU)
 Slovak - Slovakia (sk-SK)
 Slovenian - Slovenia (sl-SI)
 Spanish - Argentina (es-AR)
 Spanish - Colombia (es-CO)
 Spanish - Mexico (es-MX)
 Spanish - Spain (es-ES)
 Spanish - United States (es-US)
 Swedish - Sweden (sv-SE)
 Tamil - India (ta-IN)
 Telugu - India (te-IN)
 Thai - Thailand (th-TH)
 Turkish - Turkey (tr-TR)
 Urdu - Pakistan (ur-PK)
 Uzbek - Uzbekistan (uz-UZ)

Defining Custom Locales

There are two methods to define locales not already pre-defined in Composer:

- When creating a new Project via the New Composer Project wizard. Select **File > New > Java**

Composer Project or **File > New > .NET Composer Project**. The Define Composer Project Locales page appears after the option to select a template. Click **Add Custom** to open the Add Custom Locale dialog box shown below.

- For an existing Project, right-click the Composer Project in the Project Explorer, select **Properties**, select the **Locales**, and then click **Add Custom**. This opens the Add Custom Locale dialog box shown below.

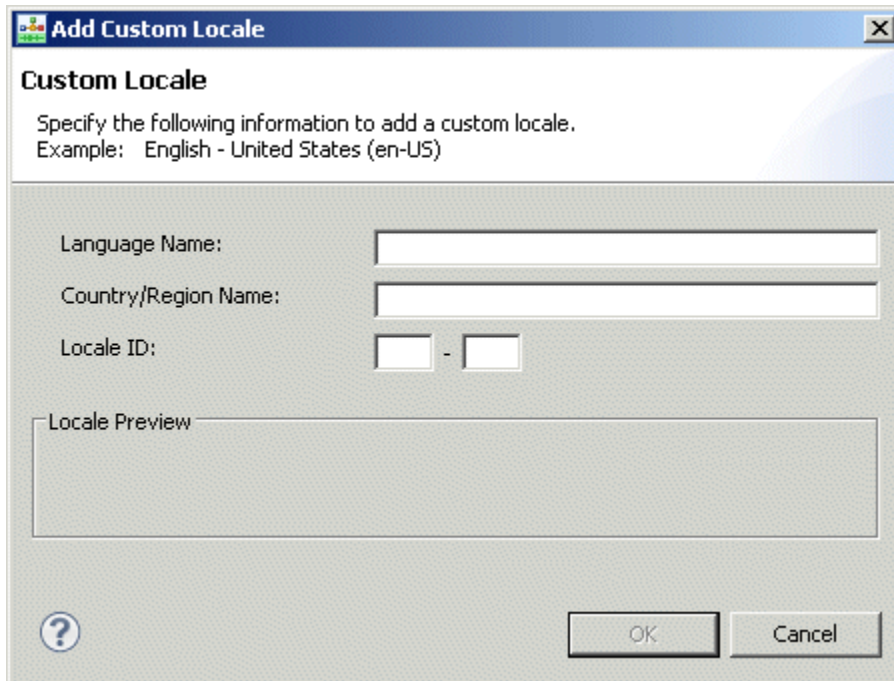

1. Enter the **Language Name**.
2. Enter the **Country/Region Name**.
3. Enter the **Locale ID** by specifying the two-letter language codes. Examples:
 - en-IN (which represents English-India)
 - en-SC (which represents English-Scottish)
 - en-IE (which represents English-Irish))
4. Click **OK**. After clicking OK, the custom locale is listed for selection on the Locales properties page. Adding a custom locale also activates the **Delete Custom Locale** button on that page.
5. Create the processing logic. See [Processing Prompts Other Than en-US](#).

Locales Other than United States

When Composer is first installed, the default locale is set to English (en-US). Composer bundles a sample set of prompt file resources specifically for en-US, which is located in the following Composer Project directory `../Resources/Prompts/en-US/` The prompt audio resources located in this

directory are used when processing a prompt. such as a prompt for a date/time, and so on. Composer provides the business logic to process prompts for locale United States -- English (en-US). This file is located in the Composer project location: `../Resources/Prompts/en-US/en-US.js`

Processing Prompts Other Than en-US

When using locales other than en-US in a callflow application, you must define your own prompt business logic. Certain steps are needed to ensure that the prompts will process correctly. The steps are as follows:

1. Under each locale directory (`../Resources/Prompts/<locale>/`), create a JavaScript locales file with the locale's ID as its file name. A sample locale template JavaScript file is provided with instructions located under the Composer Project: `../Resources/Prompts/xx-XX.js`. For example: `../Resources/Prompts/es-MX/es-MX.js`
2. Define the contents of the locale file created in previous step:

The function name must be of format `xxXXPlayBuiltinType`, where `xxXX` is the locale ID without the hyphen; for example: `es-MX = esMPlayBuiltinType` In the `PlayBuiltinType` function, define the business logic for processing the prompt for that particular locale.

```
// The language object function name should correspond with its locale ID.
function esMXPlayBuiltinType(value, type, promptUrl, format)
{
    //The main function name must be of the format:
    xxXXPlayBuiltinType
    //Where 'xxXX' is the locale ID without the hyphen.
    //i.e. en-US -> enUSPlayBuiltinType()

    // Define your prompt resource business logic
    var promptsArray = new Array(1);
    ...
    return promptsArray;
}
```

Note: When declaring other functions in the JavaScript locale file, the function names must not duplicate the function names in other JavaScript locale files. Composer recommends pre-pending the locale ID to the function names, i.e., for locale es-MX use `esMXMyFunctionName`).

Important

Composer ships only with a sample set of prompt file resources specifically for en-US. Composer auto-generates only English language .vox files as part of a Project that is configured for en-US and does not do this for other languages.

Developing Multi-Lingual Applications

This section provides information on how you can build multilingual applications in Composer. **How Can I Work with Multiple Languages in a Composer Project?** A Composer Project has a working set of active language locales that maybe used in an application. These language locales can essentially be used within a Composer application. You may set the Project locales in two ways.

1. During the creation of a Composer Project, the new Composer Project wizard lets you select the default and active locales within the Project.
2. Once a Composer Project is created, you may also modify the working set of language locales through the Project properties under the Locales section.

How Can I Change the Language for an Application at Runtime? For a multilingual application, if the application needs to change the language for the prompts and grammars based on your input or other settings, use the following steps:

1. On the callflow diagram, the Entry block variables property will contain the variable **APP LANGUAGE** . Set the value of this variable to the correct TTS language value.
2. Place the appropriate blocks and links on the diagram. To switch to another language in the callflow, use the **Set Language block**.
3. The blocks subsequent to the Set Language block will then be of the switched language. When using Prompt blocks, the prompt resources located in the appropriate language locale directory will be used. For example:
 - United States -- English (en-US) will use resources from `../Resources/Prompts/en-US/`
 - France -- French (fr-FR) will use resources from `../Resources/Prompts/fr-FR/`

If you are using a TTS engine and/or an ASR engine, you must have the language packs for the TTS vendor and/or the ASR vendor installed on the TTS and/or ASR servers. Why does my application fail to play prompts of different locales? When Composer is first installed, the default locale is set to English (en-US). Composer provides the business logic to process prompts for en-US. In a callflow application, when using locales other than en-US, some steps are needed to ensure that the prompts will process correctly. See the **Using Non-U.S. Locales** below for more information.

Multi-Lingual Application Prompts

You can create applications that play a prompt type resource in one language (for example: `../Resource/Prompts/en-US/`), switch the language using Set Language block, then play another prompt type resource using a different language (for example: `../Resource/Prompts/es-MX/`). **Multi-Lingual Application Prompts Using Composer 8.0.4 and Later** To create a multi-lingual application prompts:

1. Create a multilingual callflow diagram where the language is being switched using the **Set Language block** and the prompts are set accordingly.
2. Generate the code for the callflow diagram file. The VXML is generated.
3. Under each locale directory (`../Resources/Prompts/<locale>/`), create a JavaScript locales file with the locale's ID as its file name. Use the template locales file provided in the Project Explorer (`../Resources/Prompts/xx-XX.js`) and follow its instructions about creating the corresponding locales .js file; for

example: `..Resources/Prompts/es-MX/es-MX.js`

4. In the prompts locale file, created in previous step, implement the following content:

- Create the language object function. The function name must be of format 'xxXXPlayBuiltinType', where 'xxXX' is the locale ID without the hyphen. For example: es-MX -> esMXPlayBuiltinType
- In the language object function, implement the main function as shown below and define the business logic for processing the prompt.

```
// The language object function name should correspond with its locale ID.
function esMXPlayBuiltinType(value, type, promptUrl, format)
{
    //The main function name must be of the format:
    xxXXPlayBuiltinType
    //Where 'xxXX' is the locale ID without the hyphen.
    //i.e. en-US -> enUSPlayBuiltinType()

    // Define your prompt resource business logic
    var promptsArray = new Array(1);
    return promptsArray;
}
```

5. Run the application

Using 8.0.3 or Older Composer Projects To upgrade an existing multi-lingual application with the en-US locale:

1. In the Project Explorer, right-click the Project and select **Upgrade to Composer 8.1**.
2. (Optional) If you have previously modified PlayBuiltinType.js, copy over any changes. The resource `../Resources/Prompts/en-US/PlayBuiltinType.js` has already been upgraded. Previous Composer Project files are archived in the archive folder during an upgrade.
3. Under each locale directory `../Resources/Prompts/<locale>/`, create a JavaScript locales file with the locale's ID as its file name. Use the locales template file provided in the Project Explorer (`../Resources/Prompts/xx-XX.js`). Follow its instructions about creating the corresponding locales .js file; for example: `../Resources/Prompts/es-MX/es-MX.js`
4. In the prompts locale file created in previous step, implement the following content:
 - Create the language object function. The function name must be of format 'xxXXPlayBuiltinType', where 'xxXX' is the locale ID without the hyphen. For example: es-MX -> esMXPlayBuiltinType
 - In the language object function, implement the main function as shown as shown above in step 4.b. for Composer 8.0.4 and Later and define the business logic for processing the prompt.

Non en-US Locales

To upgrade an existing multi-lingual application with non en-US locales:

1. In the Project Explorer, right-click the Project and select **Upgrade to Composer 8.0.4**.
2. Under each locale directory '`..Resources/Prompts/<locale>/`', create a JavaScript locales file with the locale's ID as its file name. Use the template locales file provided in the Project Explorer (`..Resources/Prompts/xx-XX.js`) and follow its instructions about creating the corresponding locales `.js` file; for example: `..Resources/Prompts/es-MX/es-MX.js`
3. In the prompts locale file created in the previous step, implement the following content:
 - Create the language object function. The function name must be of format '`xxXXPlayBuiltinType`', where '`xxXX`' is the locale ID without the hyphen. For example: `es-MX` -> `esMXPlayBuiltinType`
 - In the language object function, implement the main function with the business logic for processing the prompt inline.

Time Zone Preferences

Composer displays all date/time elements in the user-preferred time zone with the time zone identifier. You can change the preferred time zone in **Window > Preferences > Composer > Context Services**.

Using User Data

Blocks for User Data

To work with User Data in Composer, you can use:

- The **Interaction Data block** for voice applications.
- The **User Data** property of the External Service block if you wish to pass User Data to an external service (routing and voice).
- The Entry block to access User Data (routing and voice).

For routing applications, you can use:

- The **User Data block**.
- The **Create Email block**, which lets you pick up standard response text from User Data.
- The **Create SMS block**, which lets you pick up message text from User Data.
- The **Identify Customer block**, which provides an option to update the interaction's User Data with the parameters returned by Universal Contact Server (Contact attribute data).
- The **Create Interaction block**, which lets you create a new interaction record in UCS database based on User Data.
- The **ECMAScript block**. The Script property lets you use Universal Routing Server User Data functions. Open **ExpressionBuilder**. Select URS Functions and then `_genesys.ixn.deleteuData` (to add a User Data property or delete all properties) or `_genesys.ixn.setuData` (to add new or update existing User Data).

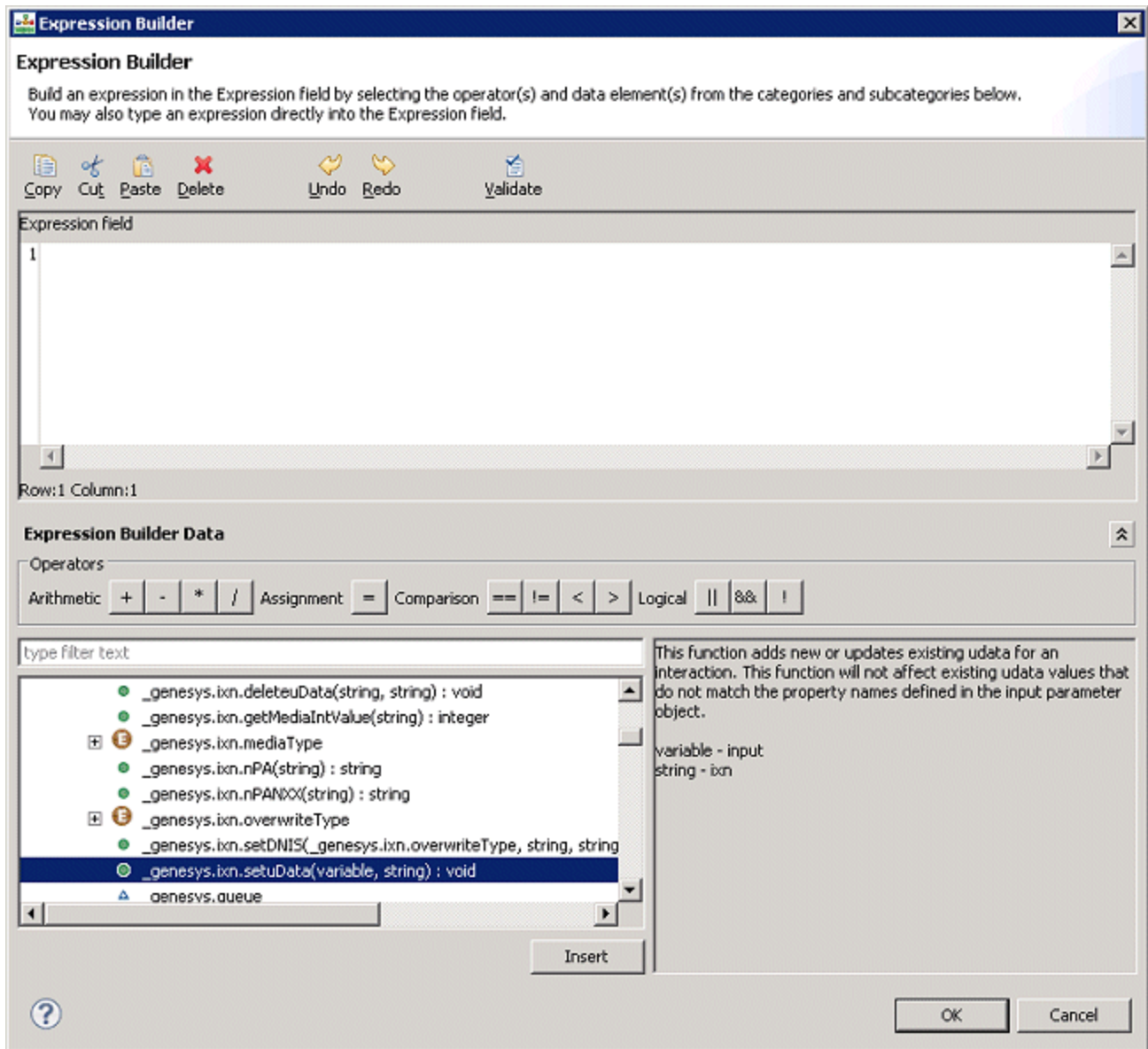

Hints

- A specific variable 'xyz' can be accessed directly; for example: `_genesys.ixn.interactions[0].udata.xyz`
- To write to User Data, use the `setuData()` function in an ECMAScript snippet. Usage is similar to the example below.

```
var input = new Object();
```

```
input.xyz = InputValue1; // Specify a value for the key 'xyz'.
```

```
input['my-key-name'] = 'value'; // Use this notation if the key or property name has a hyphen in it. Note that 'my-key-name' has hyphens.
```



```
_genesys.ixn.setuData(input);
```

- Reading User Data is easier using the Assign block than with the ECMAScript block.

Mandatory Data for UCS Blocks

When working with the Update Contact and Render Message blocks (which map to Universal Contact Server services), certain properties must exist in the interaction User Data.

For the Update Contact block, ContactId must exist.

For the Render Message block, ContactId (if some contact-related Field Codes (as described in the *eServices 8.1 User's Guide*) are used in the text to render). Also InteractionId (if some interaction-related Field Codes are used in the text to render) and OwnerEmployeeId (if some agent-related Field Codes are used in the text to render).

As is the case with IRD, these properties are not set in the blocks themselves. Instead, the properties are assumed to be put in the interaction's User Data by some other block earlier in the workflow, such as the Identify Contact block or Create Interaction block with the Update User Data property set to true. In case no other block does this, the User Data block may be used for this purpose.

If these properties are not available, an explicit UCS error message (missing parameter) shows in the Orchestration Server log.

Callflow User Data

Also see the following blocks used for callflows:

- [Interaction Data](#)
- [Route Request](#)

Variables Mapping

The Context Services blocks listed below support variables mapping.



- [Identify Customer](#)
- [Query Customer](#)
- [Query Services](#)
- [Query States](#)
- [Query Tasks](#)

In addition, the eServices block, [Identify Contact](#), also supports variables mapping.

Each of the above blocks can return data as JSON objects, which can then be stored in callflow/workflow variables. When your application needs to access a property in the JSON object, you must use an [Assign block](#) to copy the property value into a variable where it can be accessed. Variable mapping allows you to specify the variables for certain properties of the resulting JSON object and, at run time, populate the variables with the property values.

When the returned data is an array of JSON objects, the variables are populated with the property values of the first item in the array. In cases where an application needs to iterate over each of the items in the array and also populate the variables with data from each item, use the [Looping block](#) with a reference to the block responsible for the retrieving the data.

To set up variable mapping for a block, use the Variables Mapping dialog box, which opens from the Variables Mapping block property in one of the Context Services blocks listed above.

1. Click under **Value** to display the  button.
2. Click the  button to open the Variables Mapping dialog box.
3. Click **Add** to open the Configure Variables Mapping dialog box.
4. Click the down arrow opposite **Variable** and select the variable into which the value needs to be stored.
5. Opposite **Mapping**, you can specify it in two ways:
 - Type in the property path to access the JSON property.
 - Select from a tree. Since the property hierarchy specification may be tedious and prone to errors, a mapping selector tree is provided below the Mapping text field. Clicking on any node within the tree will update the Mapping text field with the JSON property hierarchy of the selected node. If the selected node is an element within a JSON Array, then the mapping will display a [] implying that the hierarchy contains an array. Leaving the [] will automatically default to [0] in first item of the array.
6. Click **OK**. The Variables Mapping dialog box reflects the assignment.
7. Click **Add** again to map another variable.
8. You may continue assigning customer attributes to variables in this fashion.

Common Blocks & Functionality

This topic describes the blocks and functionality that can be used for both Orchestration routing and GVP voice applications.

Common Blocks

Composer provides the following Common blocks:

- **Assign Block.** Use to assign a computed value/expression or an entered value to a variable.
- **Branching Block.** Use as a decision point in a callflow or workflow. It enables you to specify multiple application routes based on a branching condition. Depending on which condition is satisfied, the call follows the corresponding application route.
- **Context Services Blocks.** If the Context Services capability is enabled at your site, you can use the following Context Services blocks to create callflows/workflows that extract customer data elements from the UCS Database and apply this knowledge when creating routing or voice applications.
- **Log Block.** Use to record information about an application. For example, you can log caller-recorded input collected while an application is running or error messages.
- **Looping Block.** Use to iterate over a sequence of blocks multiple times.
- **Outbound Common Blocks.** Support Genesys Outbound Contact.
- **Server-Side Blocks.** These blocks provide the ability to interact with internal and external custom server-side pages, Web Services, and URLs. These blocks can be used to exchange data like VoiceXML and SCXML variables, JSON strings between GVP interpreter, and custom server-side pages.

Common Functionality

These topics describe the Functionality that can be used for both Orchestration routing and GVP voice applications.

- [Code Generation](#)
- [Custom Blocks](#)
- [Customization Manager](#)
- [Diagram Preferences](#)
- [Exception Events](#)
- [Expression Builder](#)
- [Genesys Administration Extension Preferences](#)
- [Getting Using Email Addresses](#)

- [Import and Export](#)
- [Link Tool](#)
- [Locales](#)
- [Time Zone Preferences](#)
- [User Data](#)
- [Variables Mapping](#)

Note: Composer does not support copying blocks from a callflow to a workflow or vice-versa.

Special Note on Entry and Exit Blocks

These two blocks are also present on the palette for both routing and voice applications. The [Entry block for routing applications](#) has a different set of events than the [Entry block for voice applications](#).

Link Tools

Routing and voice applications use the same link tools:

- [Outlinks](#)
- [Exception Links](#)

Composer Help Wiki URL

The URL to the Composer Help wiki is configurable by using the Online Wiki URL field: **Window > Preferences > Composer > Help**. The default works with English but if, for example, Japanese pages were available in a different location, then you could change the URL accordingly.

Context Services Common Blocks

Important

Starting with 8.1.440.18, Composer supports Context Services 8.5, which adds support for Genesys Mobile Services. For more information, see [Context Services 8.5 Support](#).

Customer Profile Management Blocks

- **Create Customer Block** to create a callflow/workflow that includes the capability to create a customer profile through Context Services.
- **Identify Customer Block** to identify a customer in the database based on search criteria, which can be customer profile core data or customer profile extension data. If the customer is found, then Context Services can provide data that can be used to personalize offer or to resume/modify a service in process.
- **Query Customer Block** to look up a customer's core profile and profile extension attributes. Use the CustomerID to specify which customer you want to return data for. Composer stores the returned results in an application variable.
- **Update Customer Block** to update the customer profile in the database used for Context Services. You can update customer profile core data or customer profile extension data.

Service Management Blocks

Tip

If using Context Services 8.5, the database for service/state information is the Genesys Mobile Services database. If using Context Services 8.1, the database for service/state information is the Universal Contact Server database. For more information, see [General Guidelines for Context Services Preferences](#).

- **Associate Service Block** to associate an anonymous service record with a customer whose profile exists in the database used for Context Services.
- **Complete Service Block** to mark an active service as completed. You can also use this block to pass additional state-related data to the database. For example, when completing a service state, such as "Callback pending," the disposition could be "unsuccessful - no answer."

- **Complete State Block** to mark the completion of a specified state in the context of a service in the database used for Context Services.
- **Complete Task Block** to mark the application as completing a specified task within a service/state.
- **Enter State Block** to mark the entry of the application into a specified state in the context of a service.
- **Query Services Block** to query the database for a list of services associated with a particular Customer ID or, in case of unassociated services, the Contact Key. Composer stores the result in an application variable. You can query for active services, completed services, both active and completed services.
- **Query States Block** to query the database used for Context Services for active and completed states data for a specified service. You can also query for other types of service states such as user-defined service states.
- **Query Tasks Block** to query the database used for Context Services for active and completed tasks within a state for a specified service.
- **Start Service Block** to communicate the creation or start of a service in the database. The service may or may not be immediately associated with a customer. For example, an application, such as a routing workflow, may not know the customer's identity when the service is started so the service may be started anonymously. Once the customer is known and identified, the workflow may associate the anonymous service with the customer.
- **Start Task Block** to mark the application as entering a specified task within a service/state.

Also see:

- [Common Properties Context Services](#)
- [Online and Offline Modes](#)
- [Runtime Configuration](#)
- [Context Services Exception Events](#)

Context Services 8.5 Support

Starting with 8.1.440.18, Composer supports **Context Services 8.5**, which adds a group of additional capabilities that **Genesys Mobile Engagement** (GMS) provides. As a result, Composer 8.1.440.18 support for Context Services 8.5 divides into two parts:

- Support for a customer profile model (**customer profile blocks**) which is served by the Universal Contact Server API. Customer profile blocks continue to store data in the UCS Database.
- Support for a service model (**services/states/tasks blocks**), which is served by the **GMS API** (starting with UCS 8.5/GMS 8.5.1) as described in the *Context Services 8.5 User's Guide*. In Context Services 8.5, service data is stored in the Genesys Mobile Services Cassandra database. For more on this, see the **migration** section in the *Context Services 8.5 User's Guide*.

The Composer 8.1.440.18 **Context Services Preferences** dialog box reflects the customer profile and service management models.

Context Services and Composer

Starting with 8.1.440.18, Composer adds support for Context Services 8.5. See [Context Services 8.5 and Composer](#).

You can use Composer's [Context Services blocks](#) for:

1. **Service personalization.** You can create callflows/workflows that alter the customer experience based on information known about the customer.
2. **Offer personalization.** When managing conversations, routing workflows can use the results of previous offers made to the customer to decide whether a new offer should be presented.
3. **Service resumption.** Workflows can leverage service state/task information to continue a customer service that was not completed in an earlier interaction.
4. **Enhanced reporting.**

A Context Services Project [template](#) is included with this release.

You can access Context Services attributes through [Expression Builder](#).

Customer Profile Core

As described in the [Context Services User's Guide](#), the customer profile contains a core set of customer characteristics available "out-of-the-box" from Context Services. Use the [Query Customer block](#) to request (and assign to variables) the following types of customer profile information:

- **Last agent used.** Allows an application to route an interaction to the agent that last processed the last interaction for this customer.
- **Language preference.** Allows an application to use the customer's preferred language when communicating with them. This can be used in a voice Self-Service dialog, in e-mail responses, or in routing to an agent that speaks the language.
- **Preferred agent.** Allows an application to route to the customer's preferred agent if available.
- **Contact media preference.** Allows the application to use the customer preferred media when sending notifications or initiating any outbound contact with the customer. For example, use e-mail first, home phone next, commonly used web pages, and so on.

Customer Extension Data

You can extend customer profile core data with specific types of data that your business wants to include (Create Profile Extension message). For example, assume your business introduces an automated newsletter. You then might wish to add a profile extension to record customer preferences for receiving the newsletter, along with the preferred e-mail format (text or html).

Use the [Update Customer Block](#) block to update customer profile extension data.

In order for extension data to be available for selection in Composer, the data must already be defined for UCS Context Services using its HTTP interface.

Note: Composer supports multi-valued extensions starting with Universal Contact Server 8.0.2.

Identification Keys

One of the core features of the Context Services API is the ability to identify customers based on one or more attributes of the customer, known as Identification Keys. Each identification key consists of one or more attributes of the core customer profile, or of any defined extension. An attribute must be specified as an Identification Key to be usable in customer identification.

Authentication Support

Composer supports username/password authentication for VXML and SCXML-generated applications.

For Orchestration applications, username and password values are configured in the EnhancedRouting ScriptConfiguration Server object: (ApplicationParms/context_management_services_password and ApplicationParms/context_management_services_username).

For design-time access to Context Services, you can specify these values in [Context Services Preferences](#). Composer can then use them to authenticate with Context Services when it connects to Context Services for retrieving profile objects, extensions, etc. Composer updates values specified in these preferences when diagrams are [published](#) to Configuration Server.

For voice applications, username and password values are configured in the Voice Platform IVRProfile Configuration Server object (gvp.service-parameters/voicexml.cms_username and gvp.service-parameters voicexml.cms_password).

Note: Service parameter values must be prefixed with fixed, undefined or default. Else, Resource Manager throws an invalid error. For example, voicexml.cms_username=fixed,cs.

Also see [Business Rules Block Runtime Configuration](#).

Associate Service Block

Use the Associate Service block to associate an anonymous **service** record with a customer whose profile exists in the database used for Context Services.

Note: This method can be called more than once in a callflow/workflow. However, subsequent invocations override earlier associations. Therefore, if a service, that is associated with a customer, is again associated with a different customer, the earlier association will be replaced and the service will only be associated with the customer specified in the latest call.

Tip

If using Context Services 8.5, the database for service/state information is the Genesys Mobile Services database. If using Context Services 8.1, the database for service/state information is the Universal Contact Server database. For more information, see [General Guidelines for Context Services Preferences](#).

The Associate Service block has the following properties. The behavior of some properties can vary depending on whether you are in **offline or online mode**.

Name Property

Find this property's details under [Common Properties for Callflow Blocks](#) or [Common Properties for Workflow Blocks](#).

Block Notes Property

Find this property's details under [Common Properties for Callflow Blocks](#) or [Common Properties for Workflow Blocks](#).

Customer ID Property

Click the down arrow under Value and select a variable that contains the Customer Identifier for the anonymous service.

Extensions Property

Find this property's details under [Common Properties Context Services](#).

Exceptions Property

Find this property's details under [Common Properties for Callflow Blocks](#) or [Common Properties for Workflow Blocks](#).

You can also define [custom events](#).

Condition Property

Find this property's details under [Common Properties](#).

Logging Details Property

Find this property's details under [Common Properties](#).

Log Level Property

Find this property's details under [Common Properties](#).

Enable Status Property

Find this property's details under [Common Properties](#).

Application ID Property



Find this property's details under [Common Properties Context Services](#).

Application Type Property

Find this property's details under [Common Properties Context Services](#).

Estimated Duration Property

Use this property to specify the estimated service duration (in seconds).

1. Click under Value to display the  button.
2. Click the  button to open the Estimated dialog box.
3. Select **Literal** or **Variable** from the Type dropdown menu.
 - If you select Literal, enter the estimated service duration in seconds.
 - If you select Variable, select the name of the variable.
4. Click **OK** to close the dialog box.

Media Type Property

Find this property's details under [Common Properties Context Services](#).

Resource ID Property

Find this property's details under [Common Properties Context Services](#).

Resource Type Property

Find this property's details under [Common Properties Context Services](#).

Service ID Property

Find this property's details under [Common Properties Context Services](#).

Service Type Property

Find this property's details under [Common Properties Context Services](#).

Use Server Timestamp Property

Find this property's details under [Common Properties Context Services](#).

ORS Extensions Property

Starting with 8.1.4, Composer blocks used to build routing applications (with the exception of the Disconnect and EndParallel blocks) add a new [ORS Extensions](#) property.

Complete Service Block

Use this block in a callflow/workflow to mark an active [service](#) as completed in the Universal Contact Server Database used for [Context Services](#).

You can also use this block to pass additional state-related data to the database. For example, when completing a service state, such as "Callback pending," the disposition could be "unsuccessful - no answer."

Tip

If using Context Services 8.5, the database for service/state information is the Genesys Mobile Services database. If using Context Services 8.1, the database for service/state information is the Universal Contact Server database. For more information, see [General Guidelines for Context Services Preferences](#).

The Complete Service block has the following properties. The behavior of some properties will vary depending on whether you are in [offline or online mode](#).

Name Property

Find this property's details under [Common Properties for Callflow Blocks](#) or [Common Properties for Workflow Blocks](#).

Block Notes Property

Find this property's details under [Common Properties for Callflow Blocks](#) or [Common Properties for Workflow Blocks](#).

Find this property's details under [Common Properties Context Services](#).

Exceptions Property

Find this property's details under [Common Properties for Callflow Blocks](#) or [Common Properties for Workflow Blocks](#).

You can also define [custom events](#).

Condition Property

Find this property's details under [Common Properties](#).

Logging Details Property

Find this property's details under [Common Properties](#).

Log Level Property

Find this property's details under [Common Properties](#).

Enable Status Property

Find this property's details under [Common Properties](#).

Application ID Property

Find this property's details under [Common Properties Context Services](#).

Application Type Property

Find this property's details under [Common Properties Context Services](#).

Disposition Code Property

Find this property's details under [Common Properties Context Services](#).

Disposition Description Property

Find this property's details under [Common Properties Context Services](#).

Media Type Property

Find this property's details under [Common Properties Context Services](#).

Resource ID Property

Find this property's details under [Common Properties Context Services](#).

Resource Type Property

Find this property's details under [Common Properties Context Services](#).

Service ID Property

Find this property's details under [Common Properties Context Services](#).

Use Server Timestamp Property

Find this property's details under [Common Properties Context Services](#).

ORS Extensions Property

Starting with 8.1.4, Composer blocks used to build routing applications (with the exception of the Disconnect and EndParallel blocks) add a new [ORS Extensions](#) property.

Complete State Block

Use this block in a callflow/workflow to mark an active [service](#) as completed in the Universal Contact Server Database used for [Context Services](#).

You can also use this block to pass additional state-related data to the database. For example, when completing a service state, such as "Callback pending," the disposition could be "unsuccessful - no answer."

Tip

If using Context Services 8.5, the database for service/state information is the Genesys Mobile Services database. If using Context Services 8.1, the database for service/state information is the Universal Contact Server database. For more information, see [General Guidelines for Context Services Preferences](#).

The Complete Service block has the following properties. The behavior of some properties will vary depending on whether you are in [offline or online mode](#).

Name Property

Find this property's details under [Common Properties for Callflow Blocks](#) or [Common Properties for WorkflowBlocks](#).

Block Notes Property

Find this property's details under [Common Properties for Callflow Blocks](#) or [Common Properties for Workflow Blocks](#).

Find this property's details under [Common Properties ContextServices](#).

Exceptions Property

Find this property's details under [Common Properties for Callflow Blocks](#) or [Common Properties for Workflow Blocks](#).

You can also define [custom events](#).

Condition Property

Find this property's details under [Common Properties](#).

Logging Details Property

Find this property's details under [Common Properties](#).

Log Level Property

Find this property's details under [Common Properties](#).

Enable Status Property

Find this property's details under [Common Properties](#).

Application ID Property

Find this property's details under [Common Properties Context Services](#).

Application Type Property

Find this property's details under [Common Properties Context Services](#).

Disposition Code Property

Find this property's details under [Common Properties Context Services](#).

Disposition Description Property

Find this property's details under [Common Properties Context Services](#).

Media Type Property

Find this property's details under [Common Properties Context Services](#).

Resource ID Property

Find this property's details under [Common Properties Context Services](#).

Resource Type Property

Find this property's details under [Common Properties Context Services](#).

Service ID Property

Find this property's details under [Common Properties Context Services](#).

Use Server Timestamp Property

Find this property's details under [Common Properties Context Services](#).

ORS Extensions Property

Starting with 8.1.4, Composer blocks used to build routing applications (with the exception of the Disconnect and EndParallel blocks) add a new [ORS Extensions](#) property.

Create Customer Block

Use to create a callflow/workflow that includes the capability to create a customer profile through [Context Services](#). Example use cases:

- The application queried Context Services, which did not have a record for this customer.
- The application wants to create customer preference data (last agent used, language preference, preferred agent, contact media preference and ordering, contact address information, etc.) to optimize and personalize the any future processing associated with the customer.

In order to use this block in a callflow, you must have Media Control Platform (MCP) 8.1.300.76+ installed.

Tip

If using Context Services 8.5, the database for service/state information is the Genesys Mobile Services database. If using Context Services 8.1, the database for service/state information is the Universal Contact Server database. For more information, see [General Guidelines for Context Services Preferences](#).

The Create Customer block has the following properties. The behavior of some properties can vary depending on whether you are in [online or offline mode](#).

Name Property



Find this property's details under [Common Properties for Callflow Blocks](#) or [Common Properties for Workflow Blocks](#).

Block Notes Property

Find this property's details under [Common Properties for Callflow Blocks](#) or [Common Properties for Workflow Blocks](#).

Profile Data Property

Use this property to enter key-value pairs corresponding to the customer profile.

1. Click under Value to display the  button.
2. Click the  button to open the Configure Profile Data dialog box.
3. Click Add to open the Add Extension dialog box.
4. Click the down arrow, select **core** or an extension, and click **OK**. The Configure Profile Data dialog box adds **Name** and **Value** fields and a second **Add** button.
5. Click the second **Add** on the right to open the Add Attribute dialog box.
 - If you selected core, select a customer profile predefined value for Attribute. Opposite **Type**, select literal if you wish to enter the value now or variable if the value is contained in a variable. Opposite Value, enter the value or select a variable and click **OK**.
 - If you selected a customer profile extension, select a user-defined extension for Attribute. Opposite Type, select literal if you wish to enter the value now or variable if the value is contained in a variable. Opposite **Value**, enter the value or select a variable and click **OK**.

The **Name** and **Value** fields in the Configure Profile Data dialog box reflect your entries.

1. Click **Add** again to continue entering customer attributes in this fashion.

Exceptions Property

Find this property's details under [Common Properties for Callflow Blocks](#) or [Common Properties for Workflow Blocks](#). You can also define [custom events](#).

Condition Property

Find this property's details under [Common Properties](#).

Logging Details Property

Find this property's details under [Common Properties](#).

Log Level Property

Find this property's details under [Common Properties](#).

Enable Status Property

Find this property's details under [Common Properties](#).

Customer ID Property

Click the down arrow under Value and select a variable that contains the Customer Identifier for the anonymous service.

ORS Extensions Property

Starting with 8.1.4, Composer blocks used to build routing applications (with the exception of the Disconnect and EndParallel blocks) add a new [ORS Extensions](#) property.

Complete Task Block

Use this block in a callflow/workflow to mark the application as completing a specified **task** within a service/state.

Tip

If using Context Services 8.5, the database for service/state information is the Genesys Mobile Services database. If using Context Services 8.1, the database for service/state information is the Universal Contact Server database. For more information, see [General Guidelines for Context Services Preferences](#).

The Complete Task block has the following properties. The behavior of some properties will vary depending on whether you are in **offline or online mode**.

Name Property

Find this property's details under [Common Properties for Callflow Blocks](#) or [Common Properties for Workflow Blocks](#).

Block Notes Property

Find this property's details under [Common Properties for Callflow Blocks](#) or [Common Properties for Workflow Blocks](#).

Extensions Property

Find this property's details under [Common Properties Context Services](#).

Exceptions Property

Find this property's details under [Common Properties for Callflow Blocks](#) or [Common Properties for Workflow Blocks](#). You can also define **custom events**.

Condition Property

Find this property's details under [Common Properties](#).

Logging Details Property

Find this property's details under [Common Properties](#).

Log Level Property

Find this property's details under [Common Properties](#).

Enable Status Property

Find this property's details under [Common Properties](#).

Application ID Property

Find this property's details under [Common Properties Context Services](#).

Application Type Property

Find this property's details under [Common Properties Context Services](#).

Disposition Code Property

Find this property's details under [Common Properties Context Services](#).

Disposition Description Property

Find this property's details under [Common Properties Context Services](#).

Media Type Property

Find this property's details under [Common Properties Context Services](#).

Resource ID Property

Find this property's details under [Common Properties Context Services](#).

Resource Type Property

Find this property's details under [Common Properties Context Services](#).

Use Server Timestamp Property

Find this property's details under [Common Properties Context Services](#).

Service ID Property

Find this property's details under [Common Properties Context Services](#).

State ID Property

Find this property's details under [Common Properties Context Services](#).

Task ID Property

Click the down arrow under Value and select a variable that contains the ID of the task.

ORS Extensions Property

Starting with 8.1.4, Composer blocks used to build routing applications (with the exception of the Disconnect and EndParallel blocks) add a new [ORS Extensions](#) property.

Enter State Block

Use the Enter State block to mark the entry of the application into a specified **state** in the context of a **service**.

Service State Definition

Throughout their lifecycle, business services to customers proceed through a series of well-defined states (see list below). In order to personalize and properly orchestrate a service to a customer, Universal Contact Server must record when each of these predefined states is entered. For example, a company might have the following service states:

- Customer identification
- Service identification
- Assign service agent
- Waiting for service agent
- Offering another service while waiting for agent
- Offering callback
- Callback pending
- Delivering service
- Waiting for customer input
- Offering another service while delivering service

To implement these states you could create a State Business Attribute and map the above State.types to it. The list of Business Attribute values will then be available from the State Type property of this block. Note: The exact sequence of states depends entirely on the way in which the customer service application (such as an IVR or Agent Desktop application) is written.

Tip

If using Context Services 8.5, the database for service/state information is the Genesys Mobile Services database. If using Context Services 8.1, the database for service/state information is the Universal Contact Server database. For more information, see [General Guidelines for Context Services Preferences](#).

The Enter State block has the following properties. The behavior of some properties will vary depending on whether you are in **offline or online mode**.

Name Property

Find this property's details under [Common Properties for Callflow Blocks](#) or [Common Properties for Workflow Blocks](#).

Block Notes Property

Find this property's details under [Common Properties for Callflow Blocks](#) or [Common Properties for Workflow Blocks](#).

Extensions Property

Find this property's details under [Common Properties Context Services](#).

Exceptions Property

Find this property's details under [Common Properties for Callflow Blocks](#) or [Common Properties for Workflow Blocks](#). You can also define [custom events](#).

Condition Property

Find this property's details under [Common Properties](#).

Logging Details Property

Find this property's details under [Common Properties](#).

Log Level Property

Find this property's details under [Common Properties](#).

Enable Status Property

Find this property's details under [Common Properties](#).

State ID Property

Find this property's details under [Common Properties Context Services](#).

Application ID Property

Find this property's details under [Common Properties Context Services](#).

Application Type Property

Find this property's details under [Common Properties Context Services](#).

Estimated Duration Property

Find this property's details under [Common Properties Context Services](#).

Media Type Property

Find this property's details under [Common Properties Context Services](#).

Resource ID Property

Find this property's details under [Common Properties Context Services](#).

Resource Type Property

Find this property's details under [Common Properties Context Services](#).

Use Server Timestamp Property



Find this property's details under [Common Properties Context Services](#).

Service ID Property

Find this property's details under [Common Properties Context Services](#).



Previous State ID Property

Use this property to specify the ID of the state that came before this one.

1. Click under Value to display the  button.
2. Click the  button to open the Previous State ID dialog box.
3. Select **Literal** or **Variable** from the **Type** dropdown menu.
 - If you select **Literal**, enter the Previous State ID associated with the service.
 - If you select **Variable**, select a variable that contains this information.

State Type Property

Use this property to filter for specific service state types.

1. Click under Value to display the  button.
2. Click the  button to open the State Type Selection dialog box.
3. Select one of the following from the **Type** dropdown menu:
 - Context Services. Select the State Type identifier for **Value**. If Context Services attributes have been mapped to Configuration Server Business Attributes, you can select a State Type DB ID.
 - **Literal**. Enter the State Type ID.
 - Variable. Select the variable that contains the State Type ID.

ORS Extensions Property

Starting with 8.1.4, Composer blocks used to build routing applications (with the exception of the Disconnect and EndParallel blocks) add a new [ORS Extensions](#) property.

Identify Customer Block

Use this block to identify a customer in the database based on search criteria, which can be [customer profile data](#) or [customer extension](#) data. If the customer is found, then [Context Services](#) can provide data that can be used to personalize offer or to resume/modify a [service](#) in process.

Tip

If using Context Services 8.5, the database for service/state information is the Genesys Mobile Services database. If using Context Services 8.1, the database for service/state information is the Universal Contact Server database. For more information, see [General Guidelines for Context Services Preferences](#).

Prior to using this block, set [Context Services Preferences](#). For detailed information on how Universal Contact Server identifies customers, see the [Context Services User's Guide](#). For an example of how to use this block, see the [Getting and Using E-mail Addresses](#) topic.

The Identify Customer block has the following properties. The behavior of some properties can vary depending on whether you are in [offline or online mode](#).

Name Property

Find this property's details under [Common Properties for Workflow Blocks](#).

Block Notes Property

Find this property's details under [Common Properties for Workflow Blocks](#).

Extensions Property

Find this property's details under [Common Properties Context Services](#).

Get Attributes Property

Use this property to control whether only matching Customer IDs are returned (No) or whether all profile attributes are returned (Yes).

Exceptions Property

Find this property's details under [Common Properties for Workflow Blocks](#).



You can also define [custom events](#).

Suppress Customer Not Found Exception Property

- If set to true, no exception will be raised when no customer is found. The Customer Data array will be empty. See the [Customer Data](#) property below.
- If set to false (default), the `error.com.genesyslab.composer.customernotfound` exception is raised when no matching customer is found.

Customer Attributes Property

Use this property to specify a list of attributes which will be used to search for the customer. To specify customer attributes:

1. Click under Value to display the  button.
2. Click the  button to open the Customer Attributes dialog box.
3. Click **Add** in the dialog box to open the Customer Attribute dialog box.
4. Opposite **Extension**, click the down arrow and select either **Core** (for customer profile [core](#) data) or a customer profile [extension data](#).
 - If you select **Core**, select a core attribute from the **Attribute** dropdown menu. For example, you might select Core and then CustomerSegment.
 - If you select an extension, select the extension attribute name from the **Attribute** dropdown menu.



Note: In offline mode, for both core and extension data, there is an additional field "Attribute Type" where you must choose between string, Boolean, integer, long, double, date, datetime, or currency depending on the customer profile attribute definition.

5. Click the down arrow opposite Type and select **Literal** or **Variable**.

- If you select **Literal**, then for **Value**, enter the value of the attribute. For example, if you are looking for a customer having LastName=Rosen, you would key in Rosen.
 - If you select **Variable**, select the variable under **Value**.
6. Click OK to close the Customer Attribute dialog box. The Customer Attributes dialog box reflects your entries. You can also use this dialog box to edit and remove entries.

Identification Key Property

Use this property to specify the name of the key to be used for lookups. If specified, speeds the lookup. The key can be contained in a variable.

1. Click under **Value** to display the  button.
2. Click the  button to open the Identification Key dialog box.
3. Opposite **Type**, click the down arrow and select one of the following:
 - **Context Services**. Then click the *Value* down arrow and select the key. If Context Services attributes have been mapped to Configuration Server Business Attributes, you can select an Identification Key name for Value.
 - **Variable**. Select the name of the variable.
 - **Literal**. Enter the name of the key.

Customer Count Property

Click the down arrow under Value to select a variable whose value is the number of customer records returned by Universal Contact Server. This feature is for your convenience. It also serves the purpose of retaining the original number of records returned in case the returned data is modified through other blocks.

Customer Data Property

Click the down arrow under Value to select a variable whose value will be the JSON array containing data returned.

If no matching customers are found, an empty array is returned and an exception will be thrown unless the Suppress Customer Not Found Exception property is set to true.

Variables Mapping Property

Variables Mapping Property Use this property to map the JSON data returned by this block to

variables. See the [Variables Mapping](#) topic for details.

Condition Property

Find this property's details under [Common Properties](#).

Logging Details Property

Find this property's details under [Common Properties](#).

Log Level Property

Find this property's details under [Common Properties](#).

Enable Status Property

Find this property's details under [Common Properties](#).

ORS Extensions Property

Starting with 8.1.4, Composer blocks used to build routing applications (with the exception of the Disconnect and EndParallel blocks) add a new [ORS Extensions](#) property.

Using the Identify Contact and Identify Customer Blocks

- You may use the blocks Identify Contact (UCS – ESP protocol) or Identify Customer (UCS Context Services, if Context Services is enabled – REST protocol).
- In either case, the customer record is fetched into the Composer SCXML application.
- To have the customer data also available in [Interaction Workspace](#), you need to have that customer data stored into the interaction's user data, so Interaction Workspace can access it.
- If using the Identify Customer block, you can then use a User Data block to update the interaction's user data according to your needs.
- If using the Identify Contact block, the generated SCXML code automatically copies the user data part of the UCS response to the interaction's user data.
- If the Update Interaction User Data property value is true, it also automatically copies the parameters

part of the UCS response to the interaction's user data.

Query Customer Block

Use this block to look up a customer's core profile and profile extension attributes. Use the CustomerID to specify which customer you want to return data for. Composer stores the returned results in an application [variable](#). For an example of how to use this block, see the [Getting and Using E-mail Addresses](#) topic.

Tip

If using Context Services 8.5, the database for service/state information is the Genesys Mobile Services database. If using Context Services 8.1, the database for service/state information is the Universal Contact Server database. For more information, see [General Guidelines for Context Services Preferences](#).

The Query Customer block has the following properties. The behavior of some properties can vary depending on whether you are in [offline or online mode](#).

Name Property

Find this property's details under [Common Properties for Callflow Blocks](#) or [Common Properties for Workflow Blocks](#).

Block Notes Property

Find this property's details under [Common Properties for Callflow Blocks](#) or [Common Properties for Workflow Blocks](#).

Exceptions Property

Find this property's details under [Common Properties for Callflow Blocks](#) or [Common Properties for Workflow Blocks](#).

You can also define [custom events](#).

Note: The `error.com.genesyslab.composer.customernotfound` exception is raised if no customer with the specified customer ID is found.

Condition Property

Find this property's details under [Common Properties](#).

Logging Details Property

Find this property's details under [Common Properties](#).

Log Level Property

Find this property's details under [Common Properties](#).

Enable Status Property



Find this property's details under [Common Properties](#).

Customer ID Property

Click the down arrow under Value and select a variable to specify the Customer Identifier.

Include Extensions Property

Select a variable or from the list of extensions to specify which customer profile extension attributes are returned as part of the query operation.

1. Click under **Value** to display the  button.
2. Click the  button to open the Extensions dialog box.
3. Click **Add** to open the Extension dialog box.
4. Opposite **Type**, click the down arrow and select one of the following:
 - **Context Services**. Select an extension attribute already defined in the database for Value. Note: Composer supports multi-valued extensions starting with Universal Contact Server 8.0.2.
 - **Variable**. Select the variable that contains the extension.
 - **Literal**. Enter the name of the extension attribute.

5. Click **OK**. The Extensions dialog box lists the extension attribute or the name of the selected variable. You can also use this dialog box to edit and remove extensions.

Result Property

Click the down arrow and select a variable whose value contains the JSON data returned by the Context Services web service. These results will then be available in other blocks in the application for further processing.

Any post processing work to be done on returned results can be done in the existing **Assign block** which provides access to ECMAScript functions. It already supports writing simple or complex expressions to extract values out of JSON strings and arrays.

Variables Mapping Property

Find this property's details under **Common Properties Context Services**.

ORS Extensions Property

Starting with 8.1.4, Composer blocks used to build routing applications (with the exception of the Disconnect and EndParallel blocks) add a new **ORS Extensions** property.

Query Services Block

Use this block to query the [Universal Contact Server Database](#) for a list of [services](#) associated with a particular Customer ID or, in case of unassociated services, the Contact Key. Composer stores the result in an application variable. You can query for:

- Active services
- Completed services
- Both active and completed services

Use Case

[service](#)/state history is primarily meant to support service personalization and resumption. For example, a given application is using a state to record the fact that the system is waiting for the customer to fax in a signed authorization to complete a transaction. When the customer calls into the IVR to verify some recent activities, the IVR application queries the service state history and is informed that a service is waiting on a fax to arrive.

Tip

If using Context Services 8.5, the database for service/state information is the Genesys Mobile Services database. If using Context Services 8.1, the database for service/state information is the Universal Contact Server database. For more information, see [General Guidelines for Context Services Preferences](#).

The Query Services block has the following properties: Note! The behavior of some properties can vary depending on whether you are in [offline or online mode](#).

Name Property

Find this property's details under [Common Properties for Callflow Blocks](#) or [Common Properties for Workflow Blocks](#).



Block Notes Property

Find this property's details under [Common Properties for Callflow Blocks](#) or [Common Properties for](#)

Workflow Blocks.

Service Elements Property

Use this property to indicate whether information on completed service elements/tasks should be included in the returned results.

1. Click under **Value** to display the  button.
2. Click the  button to open a dialog box.
3. Check one or more of the following:
 - **Active Services**
 - **Completed Services**
 - **Active Tasks**
 - **Completed Tasks**

Extensions Property

Find this property's details under [Common Properties Context Services](#).

Exceptions Property

Find this property's details under [Common Properties for Callflow Blocks](#) or [Common Properties for Workflow Blocks](#). You can also define [custom events](#).

Condition Property

Find this property's details under [Common Properties](#).

Logging Details Property

Find this property's details under [Common Properties](#).

Log Level Property

Find this property's details under [Common Properties](#).

Enable Status Property

Find this property's details under [Common Properties](#).

Service Data Property

Click the down arrow and select a variable to contain the output data for matching services. The output of the Query Service block will be in JSON format. You will need to use the [Assign](#) block and EMCAScript in [Expression Builder](#) to parse the JSON. Below is an example of a small ECMAScript that will take the output of the Query Service block, which has been put into an application variable "QueryServices," and retrieves the service_id for the customer, if it any active services exist. It puts that service_id value into a workflow application variable called "serviceid".

```
if (QueryServices.length > 0) { serviceid = QueryServices[0].service_id; } else { serviceid = 'new service'; }
```



Note: You can also do the same things with Composer's [Variables Mapping](#) feature. It is easier (and it saves an ECMAScript block) to simply use the Variables Mapping property to map "service_id" to the application variable "serviceid".

Variables Mapping Property

Use this property to map the JSON data returned by this block to variables. See the [Variables Mapping](#) topic for details.

Identifier Property



Use this property to identify the customer. Choose the Customer ID (for associated services) or the Contact Key (for unassociated services).

1. Click under **Value** to display the  button.
2. Click the  button to open the Identifier dialog box.
3. Select one of the following buttons:
 - **Customer Identifier** (for associated services).
 - **Contact Key** (for anonymous services)
1. Click the down arrow opposite **Type** and select the source:

- **Literal.** Then enter the attribute, such as CustomerID.
- **Variable.** Then select the variable that contains the Contact Key or Customer ID.

Service Status Property

Use this property to choose the Composer method to call.



1. Click under **Value** to display the  button.
2. Click the  button to open the Service Status Selection dialog box.
3. Opposite Type, select one of the following:
 - **Variable.** Then click the **Value** down arrow and select a variable with a value of "Completed", "Active", or "All".
 - **Literal.** Then select one of the following: **Completed**, *Active*, **All**

Service Type Property

Find this property's details under [Common Properties Context Services](#).

Service Completed After Property



Use this property to filter for services completed on or after the given date/time.

1. Click under **Value** to display the  button.
2. Click the  button to open the Service Completed After dialog box.
3. Click the down arrow opposite **Type** and select one of the following:
 - **Literal.** Click arrows to select the Date and Time or manually enter.
 - **Variable.** Select the variable whose value must be formatted with the ISO 8601 UTC pattern YYYY-MM-DDTHH:mm:ss.SSSZ (for example: 2010-03-15T11:33:48.000Z).

Also see the [Time Zone Preferences](#) topic.

Service Completed Before Property



Use this property to filter for services completed prior to the given date/time. If using a variable for this property, the variable value must follow the ISO 8601 UTC pattern: [YYYY]-[MM]-[DD]T[HH]:[mm]:[ss].[SSS]Z.

1. Click under **Value** to display the  button.
2. Click the  button to open the Service Completed Before dialog box.
3. Click the down arrow opposite **Type** and select one of the following:
 - **Literal**. Click arrows to select the Date and Time or manually enter.
 - **Variable**. Select the variable whose value must be formatted with the ISO 8601 UTC pattern YYYY-MM-DDTHH:mm:ss.SSSZ (for example: 2010-03-15T11:33:48.000Z).

Also see the [Time Zone Preferences](#) topic.

Service Started After Property



Use this property to filter for services started on or after the given date/time.

1. Click under **Value** to display the  button.
2. Click the  button to open the Service Started After dialog box.
3. Click the down arrow opposite **Type** and select one of the following:
 - **Literal**. Click arrows to select the Date and Time or manually enter.
 - **Variable**. Select the variable whose value must be formatted with the ISO 8601 UTC pattern YYYY-MM-DDTHH:mm:ss.SSSZ (for example: 2010-03-15T11:33:48.000Z).

Also see the [Time Zone Preferences](#) topic.

Service Started Before Property

Use this property to filter for services started prior to the given date/time.

1. Click under Value to display the  button.
2. Click the  button to open the Service Started Before dialog box.
3. Click the down arrow opposite **Type** and select one of the following:
 - **Literal**. Click arrows to select the Date and Time or manually enter.
 - **Variable**. Select the variable whose value must be formatted with the ISO 8601 UTC pattern YYYY-MM-DDTHH:mm:ss.SSSZ (for example: 2010-03-15T11:33:48.000Z).

ORS Extensions Property

Starting with 8.1.4, Composer blocks used to build routing applications (with the exception of the Disconnect and EndParallel blocks) add a new **ORS Extensions** property.

Query States Block

Use this block to query the database used for [Context Services](#) for active and completed [states](#) data for a specified [service](#). You can also query for other types of service states such as user-defined service states.

Tip

If using Context Services 8.5, the database for service/state information is the Genesys Mobile Services database. If using Context Services 8.1, the database for service/state information is the Universal Contact Server database. For more information, see [General Guidelines for Context Services Preferences](#).

The Query States block has the following properties. The behavior of some properties can vary depending on whether you are in [offline or online mode](#).

Name Property

Find this property's details under [Common Properties for Callflow Blocks](#) or [Common Properties for Workflow Blocks](#).

Block Notes Property



Find this property's details under [Common Properties for Callflow Blocks](#) or [Common Properties for Workflow Blocks](#).

Extensions Property

Find this property's details under [Common Properties Context Services](#).

State Elements Property

Use this property to indicate whether information on completed states and/or active tasks for this service state should be included in the returned results.

1. Click under **Value** to display the  button.
2. Click the  button to open a dialog box.
3. Check one or more of the following:
 - **Active Tasks**
 - **Completed Tasks**

Exceptions Property

Find this property's details under [Common Properties for Callflow Blocks](#) or [Common Properties for Workflow Blocks](#). You can also define [custom events](#).

Condition Property

Find this property's details under [Common Properties](#).

Logging Details Property

Find this property's details under [Common Properties](#).

Log Level Property

Find this property's details under [Common Properties](#).

Enable Status Property

Find this property's details under [Common Properties](#).

States Data Property

Click the down arrow under **Value** and select a variable to contain the matched state information.

Variables Mapping Property



Find this property's details under [Common Properties Context Services](#).

Service ID Property

Find this property's details under [Common Properties Context Services](#).



State Status Property

This property controls whether Active, Completed, or All States are returned.

1. Click under **Value** to display the  button.
2. Click the  button to open the State Status dialog box.
3. Opposite **Type**, select **Variable** or **Literal**.
 - If you select **Variable**, click the **Value** down arrow and select a variable that contains the name of the method to call.
 - If you select **Literal**, click the **Value** down arrow and select one of the following: **Completed**, **Active**, or **All**.

State Types Property

Use this property to filter for other service state types, such as user-defined service states.

1. Click under Value to display the  button.
 2. Click the  button to open the State Types dialog box.
 3. Click **Add** to open the Add dialog box.
 4. Opposite **Type**, click the down arrow and select one of the following:
 - **Context Services**. Select a State Types identifier for Value. If Context Services attributes have been mapped to Configuration Server Business Attributes, you can select a State Types DB ID. If no Business Attribute is mapped in the UCS configuration, then UCS accepts any integer value which could represent a state type defined in an external client-specific database.
 - **Literal**. Then enter a preconfigured state type from the Configuration Database.
 - **Variable**. Then select the variable that contains the state type.
 5. Click **OK**. The State Types dialog box reflects your entry. You can also use this dialog box to edit and
-

remove state types.

ORS Extensions Property

Starting with 8.1.4, Composer blocks used to build routing applications (with the exception of the Disconnect and EndParallel blocks) add a new **ORS Extensions** property.

Query Tasks Block

Use this block to query the Universal Contact Server Database used for [Context Services](#) for active and completed [tasks](#) within a [service](#) for a specified service.

Tip

If using Context Services 8.5, the database for service/state information is the Genesys Mobile Services database. If using Context Services 8.1, the database for service/state information is the Universal Contact Server database. For more information, see [General Guidelines for Context Services Preferences](#).

The Query Tasks block has the following properties. The behavior of some properties will vary depending on whether you are in [offline or online mode](#).

Name Property

Find this property's details under [Common Properties for Callflow Blocks](#) or [Common Properties for Workflow Blocks](#).

Block Notes Property

Find this property's details under [Common Properties for Callflow Blocks](#) or [Common Properties for Workflow Blocks](#).

Extensions Property

Find this property's details under [Common Properties Context Services](#).

Exceptions Property

Find this property's details under [Common Properties for Callflow Blocks](#) or [Common Properties for Workflow Blocks](#). You can also define [custom events](#).

Task Data

Click the down arrow and select a variable to hold the output data for matching tasks.

Variables Mapping Property

Find this property's details under [Common Properties Context Services](#).

Service ID Property



Find this property's details under [Common Properties Context Services](#).

State ID Property

Click the down arrow under Value and select a variable that contains the ID of the newly entered/created state.



Task Status Property

This property controls whether Active, Completed, or All tasks are returned.

1. Click under Value to display the  button.
2. Click the  button to open the Task Status dialog box.
3. Opposite **Type**, you can:
 - Select **Variable** and select a variable that contains the name of the method to call.
 - Select **Literal** and select one of the following: **Completed**, **Active**, or **All**

Task Type Property

Use this property to filter for specific task types.

1. Click under Value to display the  button.
 2. Click the  button to open the Task Types dialog box.
 3. Click **Add** to open the Add dialog box.
-

4. Opposite Type, click the down arrow and select one of the following:

- **Context Services.** Select a Task Type identifier for Value. If Context Services attributes have been mapped to Configuration Server Business Attributes, you can select a Task Types DB ID. If no Business Attribute is mapped in the UCS configuration, then UCS accepts any integer value which could represent a task type defined in an external client-specific database.
- **Literal.** Then enter a pre-configured task type from the Configuration Database.
- **Variable.** Then select the variable that contains the task type.

Condition Property

Find this property's details under [Common Properties](#).

Logging Details Property

Find this property's details under [Common Properties](#).

Log Level Property

Find this property's details under [Common Properties](#).

Enable Status Property

Find this property's details under [Common Properties](#).

ORS Extensions Property

Starting with 8.1.4, Composer blocks used to build routing applications (with the exception of the Disconnect and EndParallel blocks) add a new [ORS Extensions](#) property.

Start Service Block

Use this block to communicate the creation or start of a **service** in the Universal Contact Server (UCS) Database. The service may or may not be immediately associated with a customer. For example, an application, such as a routing workflow, may not know the customer's identity when the service is started so the service may be started anonymously. Once the customer is known and identified, the workflow may associate the anonymous service with the customer.

Service Definition

Data residing in the UCS Database includes service data. A service may be seen as a communication or series of communications between a customer and an enterprise, and possibly also between various parts of the enterprise. A service has a temporal beginning and end. It may span multiple interactions and include interactions of various media types (voice, e-mail, and so on).

The scope of a given service is completely defined by your enterprise and the way its customer service applications are written (for example, an IVR or Agent application).

States and Tasks

As described in the [Context Services User's Guide](#), services are composed of any number of **states**, and states in turn can be composed of any number of tasks. Services, states, and tasks are each different types of Service Elements, which exist over an application-defined lifecycle, and have business context attached to them in the form of a disposition. Within the database, data for Service Elements is constructed based on a sequence of one or more Service Events received from an application, such as a routing workflow.

Tip

If using Context Services 8.5, the database for service/state information is the Genesys Mobile Services database. If using Context Services 8.1, the database for service/state information is the Universal Contact Server database. For more information, see [General Guidelines for Context Services Preferences](#).

The Start Service block has the following properties. The behavior of some properties will vary depending on whether you are in **offline or online mode**.

Name Property

Find this property's details under [Common Properties for Callflow Blocks](#) or [Common Properties for Workflow Blocks](#).

Block Notes Property

Find this property's details under [Common Properties for Callflow Blocks](#) or [Common Properties for Workflow Blocks](#).

Extensions Property

Find this property's details under [Common Properties Context Services](#).

Exceptions Property

Find this property's details under [Common Properties for Callflow Blocks](#) or [Common Properties for Workflow Blocks](#).

You can also define [custom events](#).

Service ID Property

Find this property's details under [Common Properties Context Services](#).

Application ID Property



Find this property's details under [Common Properties Context Services](#).

Application Type Property

Find this property's details under [Common Properties Context Services](#).



Estimated Duration Property

Use this property to specify the estimated service duration (in seconds).

1. Click under Value to display the  button.
2. Click the  button to open the Estimated dialog box.
3. Select **Literal** or **Variable** from the Type dropdown menu.
 - If you select **Literal**, enter the estimated service duration in seconds.
 - If you select **Variable**, select the name of the variable.

Identifier Property

Use this property to identify the customer. Choose the Customer ID (for associated services) or the Contact Key (for unassociated services).

1. Click under Value to display the  button.
2. Click the  button to open the Identifier dialog box.
3. Click one of the following buttons:
 - **Customer Identifier** (for associated services)
 - **Contact Key** (for anonymous services)
4. Click the down arrow opposite **Type** and select the source: **Literal** or **Variable**.
 - If you select **Literal**, enter an attribute for Value, such as CustomerID.
 - If you select **Variable**, select the variable for Value that contains either the Contact Key or the Customer ID.

Media Type Property

Find this property's details under [Common Properties Context Services](#).

Resource ID Property

Find this property's details under [Common Properties Context Services](#).

Resource Type Property

Find this property's details under [Common Properties Context Services](#).

Service Type Property

Find this property's details under [Common Properties Context Services](#).

Use Server Timestamp Property

Find this property's details under [Common Properties Context Services](#).

Condition Property

Find this property's details under [Common Properties](#).

Logging Details Property

Find this property's details under [Common Properties](#).

Log Level Property

Find this property's details under [Common Properties](#).

Enable Status Property

Find this property's details under [Common Properties](#).

ORS Extensions Property

Starting with 8.1.4, Composer blocks used to build routing applications (with the exception of the Disconnect and EndParallel blocks) add a new [ORS Extensions](#) property.

Start Task Block

Use this block to mark the application as entering a specified **task** within a **service/state**.

Tip

If using Context Services 8.5, the database for service/state information is the Genesys Mobile Services database. If using Context Services 8.1, the database for service/state information is the Universal Contact Server database. For more information, see [General Guidelines for Context Services Preferences](#).

The Start Task block has the following properties. The behavior of some properties will vary depending on whether you are in **offline or online mode**.

Name Property

Find this property's details under [Common Properties for Callflow Blocks](#) or [Common Properties for Workflow Blocks](#).

Block Notes Property

Find this property's details under [Common Properties for Callflow Blocks](#) or [Common Properties for Workflow Blocks](#).

Extensions Property

Find this property's details under [Common Properties Context Services](#).

Exceptions Property

Find this property's details under [Common Properties for Callflow Blocks](#) or [Common Properties for strategy blocks](#). You can also define **custom events**.

Task ID Property

Click the down arrow under Value and select a variable that contains the ID of the task.

Application ID Property

Find this property's details under [Common Properties Context Services](#).

Application Type Property

Find this property's details under [Common Properties Context Services](#).

Estimated Duration Property

Find this property's details under [Common Properties Context Services](#).

Media Type Property

Find this property's details under [Common Properties Context Services](#).

Resource ID Property

Find this property's details under [Common Properties Context Services](#).

Resource Type Property

Find this property's details under [Common Properties Context Services](#).

Use Server Timestamp Property

Find this property's details under [Common Properties Context Services](#).

Service ID Property



Find this property's details under [Common Properties Context Services](#).

State ID Property

Click the down arrow under Value and select a variable that contains the ID of the state.

Task Type Property

Use this property to filter for specific task types.

1. Click under Value to display the  button.
2. Click the  button to open the Task Types dialog box.
3. Click **Add** to open the Add dialog box.
4. Opposite **Type**, click the down arrow and select one of the following:
 - **Context Services**. Select a Task Type identifier for Value. If Context Services attributes have been mapped to Configuration Server Business Attributes, you can select a Task Types DB ID. If no Business Attribute is mapped in the UCS configuration, then UCS accepts any integer value which could represent a task type defined in an external client-specific database.
 - **Literal**. Then enter a pre-configured task type from the Configuration Database.
 - **Variable**. Then select the variable that contains the task type.

Condition Property

Find this property's details under [Common Properties](#).

Logging Details Property

Find this property's details under [Common Properties](#).

Log Level Property

Find this property's details under [Common Properties](#).

Enable Status Property

Find this property's details under [Common Properties](#).

ORS Extensions Property

Starting with 8.1.4, Composer blocks used to build routing applications (with the exception of the Disconnect and EndParallel blocks) add a new [ORS Extensions](#) property.

Update Customer Block

Use this block to update the customer profile in the database used for [Context Services](#). You can update customer profile or extension data. Composer supports multi-valued extensions starting with Universal Contact Server 8.0.2. For more information on Context Services attributes and extensions, see the [Context Services User's Guide](#).

Notes:

- Place this block after the Query Customer block after you place the results of the customer query in a variable. This applies if you want to update some individual customer attributes and keep the other attributes at their original values. Otherwise, to remove all older attribute values, you do not need to use a Query Customer block and the Profile Data Variable property can remain not set.
- You may wish to configure [Context Services Preferences](#). The behavior of some properties can vary depending on whether you are in [offline or online mode](#).
- Also see [Mandatory Data for UCS Blocks](#).
- If using Context Services 8.5, the database for service/state information is the Genesys Mobile Services database. If using Context Services 8.1, the database for service/state information is the Universal Contact Server database. For more information, see [General Guidelines for Context Services Preferences](#).

The Update Customer block has the following properties:

Name Property

Find this property's details under [Common Properties](#).

Block Notes Property



Find this property's details under [Common Properties](#).

Profile Data Variable

Click the down arrow under **Value** and select the variable that contains the customer profile data for the update operation. A [Query Customer block](#) can be used to initialize this variable.

Profile Data Property

Use this property to specify the core or extension customer profile data.

1. Click under **Value** to display the  button.
2. Click the  button to open the Profile Data dialog box. The first time this dialog box appears, an **Add** button appears on the left side only.
3. Click **Add** to open the Profile Attribute dialog box.
4. Click the down arrow and select either **Core** (for customer profile core data) or a customer profile extension.
5. Click **OK** to close the Profile Extension dialog box. The Profile Data dialog box adds a second column with a second **Add** button.
6. With Core or the customer profile extension still highlighted in the first column, click the **Add** button in the second column. The Customer Attribute dialog box opens. Do one of the following:
 - Opposite **Attribute**, select the attribute (core or extension depending on what you previously selected). In offline mode, there is an additional field "Attribute Type" in this dialog where you must choose between **string**, **Boolean**, **integer**, **long**, **double**, **date**, **datetime**, or **currency** depending on the customer profile attribute definition.
 - Opposite **Type**, select **Literal** or **Variable**.
 - Opposite **Value**, enter the literal or select the variable.
 - Click **OK** to close the dialog box. The Profile Data dialog box reflects your entry.
7. Repeat these steps if you wish to update another attribute.

Exceptions Property

Find this property's details under [Common Properties](#).

You can also define [custom events](#).

Customer ID Property

Click the down arrow under **Value** and select a variable to specify the Customer Identifier.

Operation Property

Use this property to select the block's operation. Click the down arrow and select one of the following:

- **Update** to update an existing customer profile.
- **Insert Extension** to insert extensions records to an existing customer profile.

Condition Property

Find this property's details under [Common Properties](#).

Logging Details Property

Find this property's details under [Common Properties](#).

Log Level Property

Find this property's details under [Common Properties](#).

Enable Status Property

Find this property's details under [Common Properties](#).

ORS Extensions Property

Starting with 8.1.4, Composer blocks used to build routing applications (with the exception of the Disconnect and EndParallel blocks) add a new [ORS Extensions](#) property.

Using Context Services Blocks

This section describes how to use the Context Services blocks.

- [Context Services and Composer](#)
- [Common Properties for Context Services](#)
- [Online and Offline Modes](#)
- [Runtime Configuration](#)
- [Context Services Exception Events](#)

Common Properties Context Services

The following properties are common to multiple Context Services blocks. Their descriptions are placed here to minimize duplication of content. The behavior of some properties can vary depending on whether you are in [offline or online mode](#).

Important

If using Context Services 8.5, the dropdown menu for some properties (for example, the Media Type Property) will be unavailable.

Name Property

Find this property's details under [Common Properties for Callflow Blocks](#) or [Common Properties for Workflow Blocks](#).

Block Notes Property

Find this property's details under [Common Properties for Callflow Blocks](#) or [Common Properties for Workflow Blocks](#).

Application ID Property

Use this property to assign a variable that contains a unique application ID (for example, a Genesys DB ID) for the application issuing the anonymous service event (for example, a GVP VoiceXML application, an Orchestration SCXML application, and so on).

Application Type Property

Use this property to assign a unique ID associated with the type or class of the application issuing the completed service event. May be used to group related applications, potentially across resource types.

1. Under **Value** to display the ... button.
2. Click the ... button to open the **Application Type** dialog box.
3. Select one of the following:

- **Context Services.** Select an Application Type identifier.
- **Variable.** Select the name of the variable that contains the Application Type identifier.
- **Literal.** Enter the Application Type.

Disposition Code Property

Use this property to assign a unique ID for the business disposition assigned to the given service/state. Typically this will be a Disposition Code Business Attribute. For more information on disposition, see the [Context Services User's Guide](#). To set this property:

1. Click under **Value** to display the ... button.
2. Click the ... button to open the **Disposition Code** dialog box.
3. Select one of the following:
 - **Literal.** Enter the Disposition Code for **Value**.
 - **Variable.** Select the name of the variable that contains the Disposition code.
 - **Context Services.** Select a Disposition code.

Disposition Description Property

Use this optional property to select a variable containing text providing additional context on the business disposition.

Extensions Property

Use this property to specify the connection to the Context Services server.

Exceptions Property

Find this property's details under [Common Properties for Callflow Blocks](#) or [Common Properties for workflow blocks](#). You can also define [custom events](#).

Condition Property

Find this property's details under [Common Properties](#).

Logging Details Property

Find this property's details under [Common Properties](#).

Log Level Property

Find this property's details under [Common Properties](#).

Enable Status Property

Find this property's details under [Common Properties](#).

Estimated Duration Property

Use this property to specify a variable for the estimated service duration (in seconds).

Media Type Property

Used to specify a particular Media Type for the service.

1. Click under **Value** to display the ... button.
 2. Click the ... button to open the Extensions dialog box.
 3. Click **Add** in the Extensions dialog box to open the **Media Type** dialog box.
 4. Opposite **Type**, click the down arrow and select one of the following:
 - **Context Services**. For **Value**, select a Media Type already defined in the database.
 - **Variable**. For **Value**, select a Media Type contained in a variable.
 - **Literal**. For **Value**, enter the name of the Media Type.
- Click **OK**.

Resource ID Property

Use this property to assign a variable containing the unique ID for the specific resource-providing service. This might be the Genesys DB ID of a specific GVP or orchestration platform, or the DB ID of a given agent, depending on the context.

Resource Type Property

Use this property to assign a unique ID associated with the type or class of resource providing service (for example, GVP, Agent Desktop, Orchestration).

1. Click under **Value** to display the ... button.
2. Click the ... button to open the **Resource Type** dialog box.
3. Select one of the following from the **Type** dropdown menu:
 - **Context Services.** Select a Resource Type identifier.
 - **Literal.** Enter the unique ID associated with the type or class of resource.
 - **Variable.** Select a variable that contains this information.

Service ID Property

Click the down arrow under Value and select a variable that contains the ID of the anonymous service.

Service Type Property

Use this property to assign a Service Type code (Business Attribute), which describes what type of service a customer is requesting at a particular moment in time. For example, an IVR system may have the customer select 1 for Loan, 2 for Investment or 3 for Information. Loan, Investment, and Information are all Service Types.

1. Click under **Value** to display the ... button.
2. Click the ... button to open the **Service Type** dialog box.
3. Click the down arrow opposite Type and one of the following:
 - **Context Services.** Select a Service Type code.
 - **Literal.** Enter a Service Type code.
 - **Variable.** Select the variable that contains the Service Type code.

State ID Property

Use this property to select a variable for the identifier for the completed **state**.

State Types Property

Use this property to filter for other service state types, such as user-defined service states.

1. Click under **Value** to display the ... button.
2. Click the ... button.

3. Click **Add** to open the **Add State Types** dialog box.
4. Opposite **Type**, click the down arrow and select one of the following:
 - **Context Services.** Select a variable for the State Type identifier. If using Context Services 8.1 and identifiers have been mapped to **Business Attributes**, you can select a State Types DB ID. If no Business Attribute is mapped, then the server accepts any integer value which could represent a state type defined in an external client-specific database.
 - **Literal.** Then enter a preconfigured state type.
 - **Variable.** Then select the variable that contains the state type.

Task Type Property

Use this property to filter for specific task types.

1. Click under Value to display the ... button.
2. Click the ... button to open the Task Types dialog box.
3. Click **Add** to open the Add dialog box.
4. Opposite Type, click the down arrow and select one of the following:
 - **Context Services.** Select a Task Type identifier for Value. If using Context Services 8.1 Context Services identifiers have been mapped to **Business Attribute** values, you can select a Task Types DB ID. If no Business Attribute is mapped, then any integer value is accepted, which could represent a task type defined in an external client-specific database.
 - **Literal.** Then enter a pre-configured task type from the Configuration Database.
 - **Variable.** Then select the variable that contains the task type.

Use Server Timestamp Property

Use this property to determine if Universal Contact Server should assign the time at which the service was associated with the customer.

- If **True**, the UTC time at which the service event was associated is assigned by the server.
 - If **False**, the UTC time is assigned by script embedded in the SCXML application.
1. Click under **Value** to display the ... button.
 2. Click the ... button to open the **User Server Timestamp** dialog box.
 3. Select one of the following:
 - **Literal.** Then for **Value**, select True or False.
 - **Variable.** Then for **Value**, select a variable that contains true or false.

Variables Mapping Property

Use this property to map the JSON data returned by this block to variables. See the [Variables Mapping](#) topic for details.

ORS Extensions Property

Starting with 8.1.4, Composer blocks used to build routing applications (with the exception of the Disconnect and EndParallel blocks) add a new [ORS Extensions](#) property.

Online and Offline Modes

Composer supports two modes during when working with Context Services blocks:

- Online mode (connected to the database)
- Offline mode (not connected to the database)

You specify online or offline mode in [Context Services Preferences](#) by checking the box opposite **Connect to the Universal Contact Server when designing diagrams** and completing the associated fields.

Online Mode

In online mode, you are connected to the Context Services server. In this case, based on Context Services Preferences, Composer accesses a specified server instance during design time, queries for information, and populates dropdown lists and other interface items appropriately. Composer opens a new connection to the server each time some data needs to be fetched. The connection is not kept alive during calls (as is the connection Configuration Server) so no connection status is displayed.

Offline Mode

An offline mode is also supported. In this mode, Composer does not contact the Context Services server during design time. Any dialogs or properties that query the server in online mode revert to an open interface in offline mode and do not show dropdown lists containing database objects. In this case, you must key in literal values or you may select variables if the particular property or dialog supports working with application variables. Note: Both these modes apply to Composer during application design. At runtime, the SCXML/VXML application will contact an instance of UCS.

Tip

When using [Context Services 8.5](#) and Genesys Mobile Services, no connection is made from Composer to GMS at design time. As described in [Context Services Preferences](#), connections to GMS are initiated only at runtime by ORS/MCP.

Runtime Configuration

This topic discusses both Workflow Diagram and Callflow Diagram runtime configuration.

Workflow Diagram Runtime Configuration

When you **publish** an interaction process diagram, Composer creates an EnhancedRouting Script object in Configuration Server. This Script object has a `context_management_services_url` parameter, which is initialized with the UCS server parameters configured in **Context Services Preferences**.

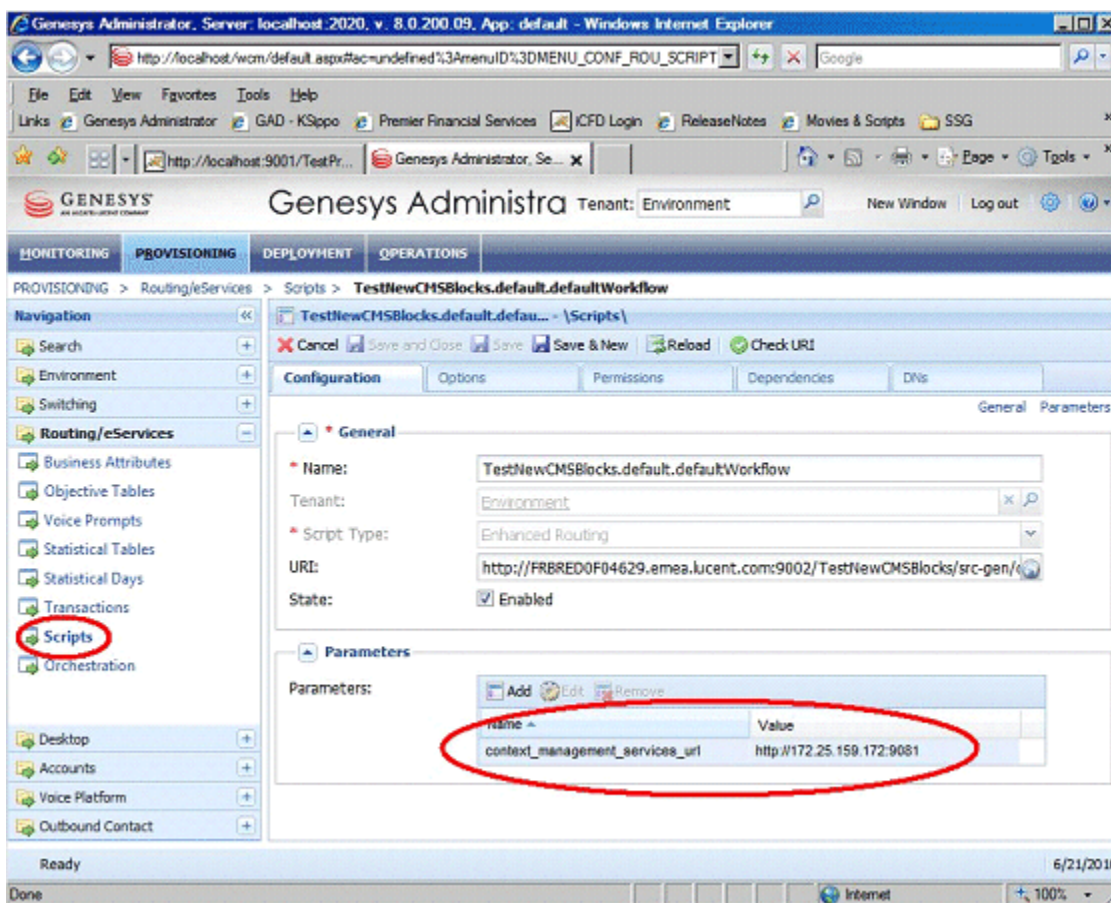

The Script objects are automatically created by Composer and the url is also automatically set if the Project is deployed within Composer (in embedded TOMCAT)

Manual Configuration

If using a DN to trigger the interaction process SCXML application, in the Annex of the DN, you must manually add the following property: `Orchestration/application=script:<Name of the Script object as defined above>`

Callflow Diagram Runtime Configuration

Update the IVR Profile to define a `context_services_url` parameter whose value points to the Context Services (UCS) URL defined in the [Context Services preference](#) page.

The screenshot shows the Genesys Administrator interface for configuring the 'RodIVRProfile'. The 'gvp.service-parameters' section is highlighted with a red oval. The configuration table is as follows:

Name	Section	Option	Value
gvp.general (1 Item)			
gvp.general/service-type	gvp.general	*service-type	voicexml
gvp.policy (4 Items)			
gvp.policy/cti-allowed	gvp.policy	cti-allowed	false
gvp.policy/outbound-call-allowed	gvp.policy	outbound-call-allowed	true
gvp.policy/transfer-allowed	gvp.policy	transfer-allowed	true
gvp.policy/use-same-gate...	gvp.policy	use-same-gateway	always
gvp.service-parameters (2 Items)			
gvp.service-parameters/v...	gvp.service-param...	voicexml.context_services_url	fixed,http://bsgenSuite801RG:8084
gvp.service-parameters/v...	gvp.service-param...	voicexml.gvp.appmodule	fixed/VXML/VCP
gvp.service-prerequisite (1 Item)			
gvp.service-prerequisite/in...	gvp.service-prereq...	initial-page-url	http://localhost:9001/TestProject/src-gen/...

Running a Callflow

This section describes the configuration required to run a callflow from a [Play Application](#) workflow block. Configure the `context_services_url` parameter in Resource Manager's default IVR Profile, which Resource Manager passes on to the VXML application.

Note: Depending on the `media-service` parameter seen in the INVITE, the service type changes for MSML call flows. If `media-service=treatment` or `conference` or `record` (recording client) or `cpd`, add the following to ensure that the `cs_services_url` parameter is populated in the Composer callflow: `treatment.context_services_url=fixed,http://demosrv8:9080`

`treatment.cs_services_url=fixed,http://demosrv8:9080/genesys/1/cs`

1. In the Sip Switch/DN/VOIP Services/MSML_Service DN (if the msml-support option is true in Sip Server) or in the standard VoipService DN (if the msml-support option is false in Sip Server): change the option contact from `sip:host_MCP:port_MCP` to `sip:host_RM:port_RM`.
2. In the Tenant object, designate a default profile for Resource Manager: `gvp.general` section, option `default-application=<name of some IVRProfile object under that tenant>`; for instance, Default Application.
3. In the IVR Profile/Default Application specified above, in the Annex, add the section `gvp.service-parameters`.
4. In the `gvp.service-parameters` section, add the option `msml.context_services_url= fixed, http://demosrv8:9080` (here, host:port of Context Management Server, which is the Server port that you specified in Context Services Preferences).
5. In the `gvp.service-parameters` section, add the option `voicexml.context_services_url= fixed, http://demosrv8:9080` (here, host:port of Context Management Server, which is the Server port that you specified in Context Services Preferences).
6. If using **Context Services 8.5** (8.1.440.18), add the option for Genesys Mobile Services url. Example: In the `gvp.service-parameters` section, add the option `voicexml.cs_services_url= fixed, http://demosrv8:9080/genesys/1/cs`.

Context Services Exception Events

Below are some common exceptions for Context Services blocks:

Exception	Number	App Last Error Description
error.com.genesyslab.composer.badRequest	400	Bad Request
error.com.genesyslab.composer.notAuthorized	401	Not Authorized
error.com.genesyslab.composer.forbidden	403	Forbidden + specific error message from the server
error.com.genesyslab.composer.notFound	404	Not Found
error.com.genesyslab.composer.serverError	500	Internal Server Error + specific error message from the server
error.com.genesyslab.composer.badGateway	502	Bad Gateway
error.com.genesyslab.composer.serviceUnavailable	503	Service Unavailable

Outbound Common Blocks

The Outbound blocks support Genesys Outbound Contact, an automated product for creating, modifying, running, and reporting on outbound campaigns for proactive customer contact. Outbound Contact Solution (OCS) provides automated dialing and call-progress detection, so that an Agent is required only when a customer is connected. Composer supplies the following Outbound blocks:

Block Name	Block Description
Add Record	Automates building of Calling Lists by adding a new record to a specified Calling List.
Cancel Record	Cancels a customer record in a calling list.
Do Not Call	Adds a contact record, such as a phone number or an e-mail address, to a specified Do Not Call List and marks the corresponding record as Do Not Call.
Record Processed	Marks a record as requiring no further handling.
Reschedule Record	Reschedules a customer interaction from the specified Calling List.
Update Record	Updates a Calling List record that you specify via a RecordHandle parameter.

OCS Variables

The Outbound blocks use [OCS variables for SCXML applications](#) and [OCS variables for VXML applications](#), present in the Entry blocks of their respective diagrams. These variables are prefixed by "OCS_" and are added to the Entry by default.

Using the Outbound Blocks

Outbound blocks are specifically designed to be used in callflows/workflows that are configured to work with Outbound records, the essential element of which is communication between Universal Routing Server (URS) and Interaction Server, and between Interaction Server and OCS. For additional information, see the [Outbound Contact](#) documentation.

Add Record Block

Use this block to automate building of Calling Lists by adding a new record to a specified Calling List. For example, you can use the Add Record block to automatically develop a Calling List, such as one to follow up on inbound calls that were abandoned during traffic peaks. You can then configure a routing workflow to detect abandoned calls and add records to the Calling List with the parameters of the incoming interactions. The Calling List can then be used by an outbound campaign that dials out to these customers during off-peak hours and has the Agent apologize and follow up. Also see:

- [OCS_Variables](#)
- [Using the Outbound Blocks](#)

This block has the following properties:

Name Property

Find this property's details under [Common Properties for Workflow Blocks](#) or [Common Properties for Callflow Blocks](#).

Block Notes Property

Find this property's details under [Common Properties for Workflow Blocks](#) or [Common Properties for Callflow Blocks](#).

Contact Info Property

Click the down arrow and select the variable that contains the contact telephone number (home, work, cell), FAX number, or e-mail address.

Contact Info Type Property

Click the down arrow and select a Contact Information Type: **No Contact Type, Home Phone, Direct Business Phone, Business with Extension, Mobile, Vacation Phone, Pager, Modem, Voice Mail, Pin Pager, Email Address, Instant Messaging.**

Exceptions Property

Find this property's details under [Common Properties for Workflow Blocks](#) or [Common Properties for Callflow Blocks](#).

Condition Property

Find this property's details under [Common Properties for Callflow Blocks](#) or [Common Properties for Workflow Blocks](#).

Logging Details Property

Find this property's details under [Common Properties for Callflow Blocks](#) or [Common Properties for Workflow Blocks](#).

Log Level Property

Find this property's details under [Common Properties for Callflow Blocks](#) or [Common Properties for Workflow Blocks](#).

Enable Status Property

Find this property's details under [Common Properties for Callflow Blocks](#) or [Common Properties for Workflow Blocks](#).

Record Status Property



Click the down arrow and select a record status, such as **Ready, Retrieved, Updated, Stale, Cancelled, Agent Error, Missed Callback**.

Record Type Property

Click down arrow and select the Type of record, such as **No Record Type, Unknown, General, Campaign Rescheduled, Personal Rescheduled, Personal Callback, Campaign CallBack, No Call**.



Call Time Property

This property specifies the time when record was called.

1. Click under **Value** to display the  button.
2. Click the  button to open the Call Time dialog box.
3. From the **Type** dropdown, do one of the following:
 - Select **Literal** from the dropdown menu and then specify the call date and time.
 - Select **Variable** from the dropdown menu and then select the variable that contains the call time.
4. Click **OK** to close the dialog box.



Call Time From Property

This property specifies the time frame when a record can be called.

1. Click under **Value** to display the  button.
2. Click the  button to open the Call Time From dialog box.
3. From the **Type** dropdown, do one of the following:
 - Select **Literal** from the dropdown menu and then specify the time.
 - Select **Variable** from the dropdown menu and then select the variable that contains the time.
4. Click **OK** to close the dialog box.

Call Time Until Property



This property specifies the time frame when a record can be called.

1. Click under **Value** to display the  button.
 2. Click the  button to open the Call Time Until dialog box.
 3. From the **Type** dropdown, do one of the following:
 - Select **Literal** from the dropdown menu and then specify the time.
 - Select **Variable** from the dropdown menu and then select the variable that contains the time.
-

4. Click **OK** to close the dialog box.



Scheduled Date and Time Property

This property specifies the date/time at which scheduled call should be dialed.

1. Click under **Value** to display the  button.
2. Click the  button to open the Scheduled Data and Time dialog box.
3. From the **Type** dropdown, do one of the following:
 - Select **Literal** from the dropdown menu and then specify the date and time.
 - Select **Variable** from the dropdown menu and then select the variable that contains the date and time.
4. Click **OK** to close the dialog box.

Time Zone Property

This property specifies the name of a Time Zone, associated with the customer record and configured in Configuration Server.



1. Click under **Value** to display the  button.
2. Click the  button to open the Time Zone dialog box.
3. From the **Type** dropdown, do one of the following:
 - If you are **connected to Configuration Server**, select **Configuration Server** from the dropdown menu. Select the Time Zone from the **Value** field.
 - Select **Literal** from the dropdown menu and then enter the Time Zone in the **Value** field.
 - Select **Variable** from the dropdown menu and then select the variable that contains the Time Zone from the **Value** field.
4. Click **OK** to close the dialog box.

Attempts Property

Click the down arrow and select the variable that specifies the maximum number of attempts to dial the record in the Calling List during one Campaign.

Calling List Property

This property specifies the name of a Calling List, which is configured in Configuration Server.



1. Click under **Value** to display the  button.
2. Click the  button to open the Calling List dialog box.
3. From the **Type** dropdown, do one of the following:
 - If you are **connected to Configuration Server**, select **Configuration Server** from the dropdown menu. Select the Calling List from the **Value** field.
 - Select **Literal** from the dropdown menu and then enter the Calling List in the **Value** field.
 - Select **Variable** from the dropdown menu and then select the variable that contains the Calling List from the **Value** field.
4. Click **OK** to close the dialog box.

Call Result Property

Click the down arrow and result code as defined in a Configuration Manager Enumeration table, such as Abandoned, Agent Callback Error, All Agents Busy, Answer, Answering Machine Detected, Bridged, Busy, Call Drop Error, and so on.

Campaign Property

This property specifies the name of an Outbound Campaign associated with the Calling List, which is configured in Configuration Server.

1. Click under **Value** to display the  button.
2. Click the  button to open the Campaign dialog box.
3. From the **Type** dropdown, do one of the following:
 - If you are **connected to Configuration Server**, select **Configuration Server** from the dropdown menu. Select the Campaign from the **Value** field.
 - Select **Literal** from the dropdown menu and then enter the Campaign in the **Value** field.
 - Select **Variable** from the dropdown menu and then select the variable that contains the Campaign from the **Value** field.
4. Click **OK** to close the dialog box.

Chain ID Property

Click the down arrow and select the variable that contains a unique chain identifier (optional). If missing, it is assumed that a record forms a new chain.

Chain N Property



Click the down arrow and select the variable that contains a unique number in a chain (optional). If missing, the next available number is assigned.

OC Server Property

This property identifies the Outbound Contact Server that will interact with the block. You can specify a different OCS application for a specific block. By default, the OCS_URI **application variable** is used. If the datasource is Config Server, Composer will read the OCS host, listening port and connection protocol from config server. If the datasource is Literal/Variable, the format should be [http|https]://<host>:<port>.

User Data Property

Use this property to specify key-value pairs for user data attached to the interaction.

1. Click under **Value** to display the  button.
2. Click the  button to open the User Data dialog box.
3. Click **Add** to open the Select Items dialog box.
4. Opposite Key, leave Literal in the first field and enter the input parameter name in the second field.
5. Opposite **Value**, click the down arrow and select either literal or variable.
 - If you select **Literal**, enter the name of the key in the second field.
 - If you select **Variable**, select the name of the variable from the second field.
 - Select the **Value is numeric box if applicable**.
6. Click **OK** to close the Select Items dialog box. The User Data dialog box shows your entry.
7. Continue adding parameters in this fashion.
8. Click **OK** when through in the User Data dialog box.

ORS Extensions Property

Starting with 8.1.4, Composer blocks used to build routing applications (with the exception of the Disconnect and EndParallel blocks) add a new **ORS Extensions** property.

Cancel Record Block

Use this block to cancel a customer record in a calling list. You can identify the customer record to cancel by using the Record Handle, Contact Info, or Customer ID property (one of these must be specified). If you specify more than one of these properties, the identifiers are prioritized as follow: Record Handle (highest), Contact Info, Customer ID (lowest). This block has the following properties:

Name Property

Find this property's details under [Common Properties for Workflow Blocks](#) or [Common Properties for Callflow Blocks](#).

Block Notes Property

Find this property's details under [Common Properties for Workflow Blocks](#) or [Common Properties for Callflow Blocks](#).

Exceptions Property

Find this property's details under [Common Properties for Workflow Blocks](#) or [Common Properties for Callflow Blocks](#).

Condition Property

Find this property's details under [Common Properties for Callflow Blocks](#) or [Common Properties for Workflow Blocks](#).

Logging Details Property

Find this property's details under [Common Properties for Callflow Blocks](#) or [Common Properties for Workflow Blocks](#).

Log Level Property

Find this property's details under [Common Properties for Callflow Blocks](#) or [Common Properties for Workflow Blocks](#).

Enable Status Property

Find this property's details under [Common Properties for Callflow Blocks](#) or [Common Properties for Workflow Blocks](#).

Contact Info Property

Select the variable that contains contact information, such as telephone number (home, work, cell), FAX number, or e-mail address. This parameter can be used for Inbound calls to reference the customer record when Record Handle is not available.

Customer ID Property

Select the variable that identifies the customer when a user-defined field is present in the calling list as described in the *Outbound Contact 8.1 Deployment Guide*. You can use for Inbound calls to reference the customer record when Record Handle is not available.

OC Server Property

This property identifies the Outbound Contact Server processing this Calling List. By default, the `OCS_URI` [application variable](#) is used. If the datasource is Config Server, Composer will read the OCS host, listening port and connection protocol from config server. If the datasource is Literal/Variable, the format should be `[http|https]://<host>:<port>`.

Record Handle Property

Select the variable that identifies the customer using the Record ID assigned by Outbound Contact Server if available. Either Record Handle, Contact Info or Customer ID must be specified.

Tenant Property

Select the variable that identifies the tenant associated with the Calling List.

Update Record Chain Property

Select False to indicate if only the customer record should be cancelled. Select True if all records chained to the customer record should be canceled.

ORS Extensions Property

Starting with 8.1.4, Composer blocks used to build routing applications (with the exception of the Disconnect and EndParallel blocks) add a new **ORS Extensions** property.

Do Not Call Block

Use this block to add a contact record, such as a phone number or an e-mail address, to a specified Do Not Call List and marks the corresponding record as Do Not Call. **Note:** Do not use the Do Not Call and Record Processed blocks to finalize Outbound record processing. You cannot use other Outbound blocks to process records with the same Record Handle after using Processed or Do Not Call in a workflow. This block has the following properties:

Name Property

Find this property's details under [Common Properties for Workflow Blocks](#) or [Common Properties for Callflow Blocks](#).

Block Notes Property

Find this property's details under [Common Properties for Workflow Blocks](#) or [Common Properties for Callflow Blocks](#).

Exceptions Property

Find this property's details under [Common Properties for Workflow Blocks](#) or [Common Properties for Callflow Blocks](#).

Condition Property

Find this property's details under [Common Properties for Callflow Blocks](#) or [Common Properties for Workflow Blocks](#).

Logging Details Property

Find this property's details under [Common Properties for Callflow Blocks](#) or [Common Properties for Workflow Blocks](#).

Log Level Property

Find this property's details under [Common Properties for Callflow Blocks](#) or [Common Properties for Workflow Blocks](#).

Enable Status Property

Find this property's details under [Common Properties for Callflow Blocks](#) or [Common Properties for Workflow Blocks](#).

Contact Info Property

Select the variable that contains contact information, such as telephone number (home, work, cell), FAX number, or e-mail address. This parameter can be used for Inbound calls to reference the customer record when Record Handle is not available.

Customer ID Property

Select the variable that identifies the customer when a user-defined field is present in the Calling List as described in the *Outbound Contact 8.1 Deployment Guide*. You can use for Inbound calls to reference the customer record when Record Handle is not available.

OC Server Property

This property identifies the Outbound Contact Server processing this Calling List. By default, the `OCS_URI` [application variable](#) is used. If the datasource is Config Server, Composer will read the OCS host, listening port and connection protocol from config server. If the datasource is Literal/Variable, the format should be `[http|https]://<host>:<port>`.

Record Handle Property

Select the variable that identifies the customer using the Record Handle if available. Either Record Handle, Contact Info or Customer ID must be specified.

Tenant Property

Select the variable that identifies the tenant associated with the Calling List.

Update Record Chain Property

Select False to indicate if only the customer record should be cancelled. Select True if all records chained to the customer record should be canceled.

ORS Extensions Property

Starting with 8.1.4, Composer blocks used to build routing applications (with the exception of the Disconnect and EndParallel blocks) add a new **ORS Extensions** property.

Record Processed Block

Use the Record Processed block to mark a record as requiring no further handling. When an Agent finishes processing a Calling List record, Genesys Desktop sends a RecordProcessed event to indicate that the record is processed and Outbound Contact Server updates the record accordingly. Use the Record Processed block in a workflow to have URS request (through Interaction Server) that Outbound Contact Server finish processing a record created as a result of a customer inquiry. For additional information on using this block, including returned results and fault codes, consult the *Universal Routing 8.1 Reference Manual* and the section on updating call results and custom fields in the *Outbound Contact 8.1 Reference Manual*.

Important

Do not use the Do Not Call and Record Processed blocks to finalize Outbound record processing. You cannot use other Outbound blocks to process records with the same Record Handle after using Processed or Do Not Call in workflow.

This block has the following properties:

Name Property

Find this property's details under [Common Properties for Workflow Blocks](#) or [Common Properties for Callflow Blocks](#).

Block Notes Property

Find this property's details under [Common Properties for Workflow Blocks](#) or [Common Properties for Callflow Blocks](#).

Exceptions Property

Find this property's details under [Common Properties for Workflow Blocks](#) or [Common Properties for Callflow Blocks](#).

Condition Property

Find this property's details under [Common Properties for Callflow Blocks](#) or [Common Properties for](#)

Workflow Blocks.

Logging Details Property

Find this property's details under [Common Properties for Callflow Blocks](#) or [Common Properties for Workflow Blocks](#).

Log Level Property

Find this property's details under [Common Properties for Callflow Blocks](#) or [Common Properties for Workflow Blocks](#).

Enable Status Property



Find this property's details under [Common Properties for Callflow Blocks](#) or [Common Properties for Workflow Blocks](#).

OC Server Property

This property identifies the Outbound Contact Server that will interact with the block. You can specify a different OCS application for a specific block. By default, the OCS_URI [application variable](#) is used. If the datasource is Config Server, Composer will read the OCS host, listening port and connection protocol from config server. If the datasource is Literal/Variable, the format should be [http|https]://<host>:<port>.

User Data Property

Use this property to specify key-value pairs for user data attached to the interaction.

1. Click under **Value** to display the  button.
 2. Click the  button to open the User Data dialog box.
 3. Click **Add** to open the Select Items dialog box.
 4. Opposite Key, leave Literal in the first field and enter the input parameter name in the second field.
 5. Opposite **Value**, click the down arrow and select either literal or variable.
 - If you select **Literal**, enter the name of the key in the second field.
 - If you select **Variable**, select the name of the variable from the second field.
-

- Select the **Value is numeric box if applicable**.
6. Click **OK** to close the Select Items dialog box. The User Data dialog box shows your entry.
 7. Continue adding parameters in this fashion.
 8. Click **OK** when through in the User Data dialog box.

ORS Extensions Property

Starting with 8.1.4, Composer blocks used to build routing applications (with the exception of the Disconnect and EndParallel blocks) add a new **ORS Extensions** property.

Reschedule Record Block

Use this block to Reschedule a customer interaction from the specified Calling List. A record is typically rescheduled during a call when a customer requests a callback at a certain time. For additional information on using this block, including returned results and fault codes, consult the *Universal Routing 8.1 Reference Manual* and the section on updating call results and custom fields in the *Outbound Contact 8.1 Reference Manual*. This block has the following properties:

Name Property

Find this property's details under [Common Properties for Workflow Blocks](#) or [Common Properties for Callflow Blocks](#).

Block Notes Property

Find this property's details under [Common Properties for Workflow Blocks](#) or [Common Properties for Callflow Blocks](#).

Exceptions Property

Find this property's details under [Common Properties for Workflow Blocks](#) or [Common Properties for Callflow Blocks](#).

Condition Property

Find this property's details under [Common Properties for Callflow Blocks](#) or [Common Properties for Workflow Blocks](#).

Logging Details Property

Find this property's details under [Common Properties for Callflow Blocks](#) or [Common Properties for Workflow Blocks](#).

Log Level Property



Find this property's details under [Common Properties for Callflow Blocks](#) or [Common Properties for Workflow Blocks](#).

Enable Status Property

Find this property's details under [Common Properties for Callflow Blocks](#) or [Common Properties for Workflow Blocks](#).

OC Server Property



This property identifies the Outbound Contact Server (OCS) application that the block will interact with. It allows you to specify a different OCS application for a specific block. By default, the OCS_Record_URI application variable is used.

1. Click under **Value** to display the  button.
2. Click the  button to open the Application Selection dialog box.
3. The next step depends on whether you are connected to Configuration Server.
 - If you are connected, select **Configuration Server** from the **Type** dropdown menu. Select the name of the Outbound Contact Server object from the **Value** field.
 - You can also select **Literal** and enter the name of the server in the **Value** field.
 - You can also select **Variable** and select the variable containing the name from the **Value** field.

If the datasource is Configuration Server, Composer reads the OCS host, listening port, and connection protocol from Configuration Server. If the datasource is Literal/Variable, use the format [http|https]://<host>:<port>.

Scheduled Date and Time Property

Specify the date/time at which scheduled call should be dialed.

1. Click under **Value** to display the  button.
2. Click the  button to open the Scheduled Date and Time dialog box.
3. The next step depends on whether you are connected to Configuration Server.
4. Do one of the following.
 - Select **Literal** and select the date and time from the **Value** field.

- Select **Variable** and select the name of the variable containing the date and time.
- Select **Delay** and select an amount of time to delay from the **Value** field.

ORS Extensions Property

Starting with 8.1.4, Composer blocks used to build routing applications (with the exception of the Disconnect and EndParallel blocks) add a new **ORS Extensions** property.

Update Record Block

Use this block to update a Calling List record that you specify via a RecordHandle parameter. For example, in Predictive dialing mode, this request can be used to overwrite the call result detected by call progress detection when needed. Or you can overwrite an answer call result with the wrong party call result. **Note:** When this block is executed in a workflow, it results in an External Service Request (through Interaction Server) to Outbound Contact Server. Since the request goes through Interaction Server, you must have the Genesys Multimedia product installed and an Open Media component to handle External Service processing. For additional information on using this block, including returned results and fault codes, consult the *Universal Routing 8.1 Reference Manual* and the section on updating call results and custom fields in the *Outbound Contact 8.1 Reference Manual*. This block has the following properties:

Name Property

Find this property's details under [Common Properties for Workflow Blocks](#) or [Common Properties for Callflow Blocks](#).

Block Notes Property

Find this property's details under [Common Properties for Workflow Blocks](#) or [Common Properties for Callflow Blocks](#).

Exceptions Property

Find this property's details under [Common Properties for Workflow Blocks](#) or [Common Properties for Callflow Blocks](#).

Condition Property

Find this property's details under [Common Properties for Callflow Blocks](#) or [Common Properties for Workflow Blocks](#).

Logging Details Property

Find this property's details under [Common Properties for Callflow Blocks](#) or [Common Properties for Workflow Blocks](#).

Log Level Property



Find this property's details under [Common Properties for Callflow Blocks](#) or [Common Properties for Workflow Blocks](#).

Enable Status Property

Find this property's details under [Common Properties for Callflow Blocks](#) or [Common Properties for Workflow Blocks](#).

OC Server Property



This property identifies the Outbound Contact Server (OCS) application that the block will interact with. It allows you to specify a different OCS application for a specific block. By default, the OCS_Record_URI application variable is used.

1. Click under **Value** to display the  button.
2. Click the  button to open the Application Selection dialog box.
3. The next step depends on whether you are connected to Configuration Server.
 - If you are connected, select **Configuration Server** from the **Type** dropdown menu. Select the name of the Outbound Contact Server object from the **Value** field.
 - You can also select **Literal** and enter the name of the server in the **Value** field.
 - You can also select **Variable** and select the variable containing the name from the **Value** field.

If the datasource is Configuration Server, Composer reads the OCS host, listening port, and connection protocol from Configuration Server. If the datasource is Literal/Variable, use the format [http|https]://<host>:<port>.

User Data Property

Use this property to specify key value pairs for user data attached to the interaction.

1. Click under **Value** to display the  button.
2. Click the  button to open the User Data dialog box.
3. Click **Add** to open the Select Items dialog box.
4. Opposite Key, leave Literal in the first field and enter the input parameter name in the second field.
5. Opposite **Value**, click the down arrow and select either literal or variable.

- If you select **Literal**, enter the name of the key in the second field.
 - If you select **Variable**, select the name of the variable from the second field.
 - Select the **Value is numeric box if applicable**.
6. Click **OK** to close the Select Items dialog box. The User Data dialog box shows your entry.
 7. Continue adding parameters in this fashion.
 8. Click **OK** when through in the User Data dialog box.

ORS Extensions Property

Starting with 8.1.4, Composer blocks used to build routing applications (with the exception of the Disconnect and EndParallel blocks) add a new **ORS Extensions** property.

Server-Side Common Blocks

Both routing and voice applications use the Server-Side blocks.

- **Backend** (voice and route). Use to invoke custom backend Java Server Pages (JSP).
- **Business Rule** (voice and route). Use this block to have Composer query the Genesys Rules Authoring Tool (GRAT). For the Rule Package that you specify, Composer will query the GRAT for the Facts associated with the Rule Package. You can then set values for the Facts, call the Genesys Rules Engine for evaluation, and save the results in a variable.
- **DB Data** (voice and route). Use for connecting to a database and retrieving/manipulating information from/in a database. This block uses a connection profile to read database access information. It accepts a SQL query or a Stored Procedure call, which can be defined using the Query Builder or Stored Procedure Helper. It can also use a SQL script file.
- **DB Input** (voice only). Accepts a DB Data block as its data source and acts as an input field that accepts input based on a grammar created from the results returned from the database.
- **External Service** (route only). Enables routing applications to invoke methods on third party servers that comply with Genesys Interaction Server (GIS) protocol. Use to exchange data with third party (non-Genesys) servers that use the Genesys Interaction SDK or any other server or application that complies with the GIS communication protocol.
- **NDM Block**. Starting with Composer release 8.1.410.14, callflow diagrams add an NDM block to work with Nuance OSDM 6.1 modules used for speech and touch-tone IVR applications.
- **OPM Block** (voice and route). Enables VXML and SCXML applications to use Operational Parameters (OPM) which allow a business user to control the behavior of these applications externally. Operational Parameters are defined and managed in the Operational Parameter Management (OPM) feature of Genesys Administrator Extension (GAX)
- **URS Function** (route only). Introduced in 8.1.440.18. Use this block to call Universal Routing Server functions via `<session:fetch>` by the `urs` method.
- **Web Request** (voice and route). Use to invoke any supported HTTP web request or REST-style web Service. It supports PUT, DELETE, GET, and POST methods.
- **Web Service** (voice and route). Use to invoke Web Services for both routing and voice applications. Based on common Web Services standards such as XML, SOAP and WSDL instead of proprietary standards. You can pass parameters (as in subdialogs) and store the return values in variables. GET, POST, and SOAP are supported. **Note:** Currently Composer does not support SOAP 1.2. Only SOAP 1.1 is supported.

Server-Side blocks provide the ability to interact with internal and external custom server-side pages, Web Services, and URLs. These blocks can be used to exchange data like VoiceXML and SCXML variables, JSON strings between GVP interpreter, and custom server-side pages. With the exception of the **Business Rule block**, Composer uses server-side pages (ASP.NET or JSP) for implementing Server-Side block functionality. If you include these blocks in a diagram, server-side pages provided in Composer Projects are used at run time.

Important

Starting with version 8.1.450.33, Composer supports fetching HTTPS (HTTP over SSL) URLs in the Web Request and Web Service blocks. A new property category, **HTTPS Server Authentication**, with two properties, **Trust Store Location** and **Trust Store Password**, is introduced to extend support for HTTPS URLs.

Example Web Scenarios

In a typical scenario for the Web Service or Web Request block, the Composer-provided server-side page is invoked first via the platform through language appropriate tags (<session:fetch for SCXML and <data>, <subdialog> for VXML). This page, based on the input parameters specified in the block, invokes any external URL for the Web Service or Web Request blocks. In case of the Web Service block, it forms the appropriate SOAP request and sends it out. It then parses the response it receives from the external request and makes it available to the application. The figure below depicts the flow.

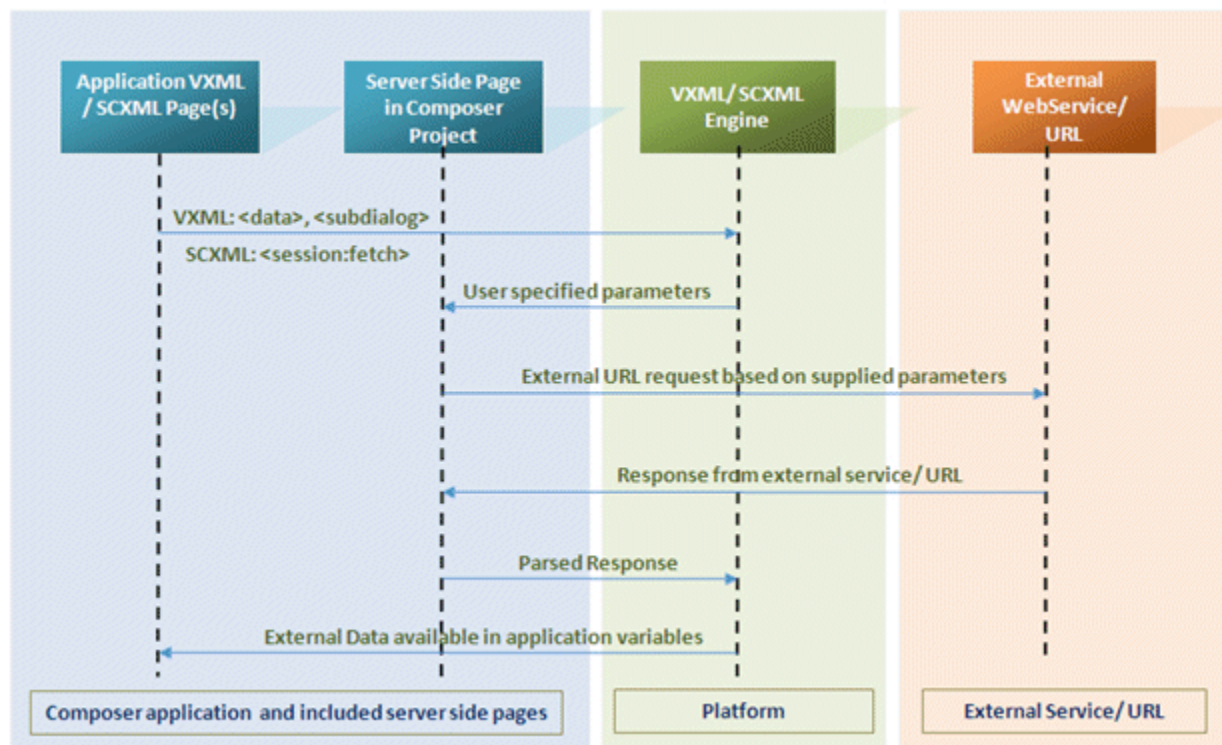

The Need for Server-Side Pages

Composer provides the Server-Side blocks in anticipation that users will usually map either their

callflows or workflows to their business logic via these blocks. For example, the Backend block offers the ability to create custom backend server pages that can be more tightly coupled with business logic and at the same time provides more flexibility since the backend logic is provided by the user. The different server-side functions offer a proxy service that can be used to query Web Services, web servers and backend server pages while providing a user interface that is simple enough to use, but also offering advanced features. Regarding security, the Web Request and Web Service blocks offer proxy clients which support HTTP, as well as SOAP. Composer supports Server-Side pages in both Java and .NET.

- Java server pages are hosted on Apache Tomcat, which is packaged and deployed with Composer.
- .NET applications are hosted on Microsoft IIS. The latter should be deployed by the user on the same server as Composer.

The choice between using Java or .NET is mainly dependent on what technologies are available to the user as well as the platforms. Below is a decision matrix outlining the some common situations where the most appropriate server-side block is recommended.

Situation	Recommended Block	Comments
A callflow/workflow needs to consume a Web Service which has a WSDL definition.	Web Service block	The Web Service block provides utilities to design the way the Web Service will be consumed, such as a WSDL parser. During runtime, the output results can also easily be assigned to callflow or workflow variables.
A callflow/workflow needs to query a web server for data	Web Request block	The Web Request block provides a proxy client for sending the web request, while offering functionality such as assigning the result to variables, and so on.
A REST-style web service needs to be consumed by the application.	Web Request block	The Web Request block is used to invoke any supported HTTP web request or REST-style web Service.
A callflow/workflow needs to access some data using some specific interface not using HTTP or SOAP	Backend block	The Backend block offers a proxy service to a backend application that is developed by the user and customized accordingly. The Backend block allows you to reuse custom JARs and .NET assemblies quickly since it provides an easy mechanism to pass parameters to and from the backend server page. The backend pages provide a skeleton implementation, which makes it easy and quick to start implementing custom logic which can use other user-provided libraries.
A callflow/workflow needs to do some customized post-processing to data retrieved	Backend block	The backend application will have to be created such that it retrieves the data and post-processes it accordingly.
My application does not work with either the Web Service or	Backend block	Try starting with the Backend block since the implementation is

the Web Request blocks. What can I use?

open by nature. The Backend application is designed to provide a simple interface to the actual user-specific application.

Note: The Backend server-side page called from the Backend block will be part of the project and will be included when the application project is deployed.

Configuring Log Levels for Server-Side Blocks

Beginning with release 8.1.500.03, you can configure the log levels for the various server-side blocks across projects using the **Bulk Manager**.

Important

For Java projects, information is recorded in the Composer.log file generated under <tomcat-dir>\logs\. For .NET projects, a log file is generated for each project under the **Logs** folder within each project.

- Click the **Log** tab on the Bulk Manager. The following is displayed:

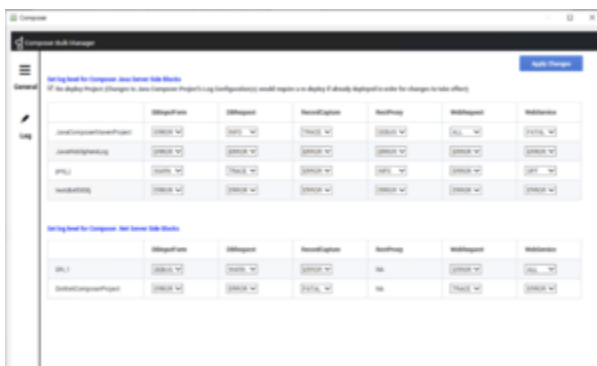

- Select the required log level from the drop-down under each server-side block. On loading Bulk Manager, the existing log level for each block (based on the **log4j.xml** file for Java projects and **web.config** file for .NET projects) is selected by default. When you change the level here, the next time Bulk Manager is loaded, the updated levels are displayed based on the corresponding config files.
- Click **Apply Changes**.
- For the server-side blocks in a Java project, the Tomcat server must be restarted for the new log file settings to be effective. The Tomcat server is restarted automatically when you click **Apply Changes**.

Important

For .NET projects, changes to the log levels are effective immediately on clicking **Apply Changes**. Restarting IIS is not required for .NET projects.

- To disable logging for a particular server-side page, select the **Off** option from the drop-down.

Note: For both .NET and Java projects, log levels can be configured for each project individually. However, prior to release 8.1.550.08, for Java projects, the log levels configuration is applied to all the projects as a whole. Each Java project cannot have log levels configured individually in releases prior to 8.1.550.08.

The following are the different log levels available:

Log Level	Description
All	All levels including custom levels.
DEBUG	Informational events that are useful in debugging an application.
ERROR	Error events that might still allow the application to continue running.
FATAL	Very severe error events that might cause the application to abort.
INFO	Informational events that highlight the progress of the application at a high-level.
OFF	No information is recorded. Logging is turned off.
TRACE	Informational events that are a level higher than the <i>Debug</i> level.
WARN	Events that maybe potentially harmful.

Note: Changes to the log levels are recorded in the **log4j2.xml** file for Java projects (for each project under the location project/WEB-INF/lib/), and the **web.config** file for .NET projects. However, prior to release 8.1.55#.##, changes to the log levels are recorded in the **log4j.xml** file for Java projects.

Important

You must launch the Composer application using the **Run as Administrator** option to be able to configure log levels for server-side blocks.

Below is a video that shows you how to configure log levels for server-side blocks using the Bulk Manager. [Link to video](#)

Backend Common Block

The Backend block is used for both routing and voice applications. Use to invoke custom backend Java Server Pages (JSP). You have the option to pass back all the application session state data to the backend logic page on the server. Data being returned will be sent back as a JSON string. Other features:

- Provides a mechanism for creating new backend logic JSP. The added JSP file will have a basic template code already filled out. As the application developer, you will only need to implement a performLogic function. The VXML/SCXML to return back control will be auto-generated in the template.
- User-written custom backend logic pages are stored in the Java Composer Project's src folder. Composer provides standard include files for Backend logic blocks in the Java Composer Project's include folder.

Important

If any custom backend logic pages use libraries, place the libraries in the Java Composer Project's WEB-INF/libdirectory. This directory typically contains JAR files that contain Java class files (and associated resources) required for the application. The Tomcat application server should be restarted after changing any JAR files in this folder. Composer includes a CHEAT SHEET for creating a Backend logic application as well.

The Backend block has the following properties:

Name Property

Find this property's details under [Common Properties for Callflow Blocks](#) or [Common Properties for Workflow Blocks](#).

Block Notes Property

Find this property's details under [Common Properties for Callflow Blocks](#) or [Common Properties for Workflow Blocks](#).

Exceptions Property

Find this property's details under [Common Properties for voice blocks](#) or [Common Properties for Workflow Blocks](#).

Uri Property

The Uri property specifies the http:// page to invoke. To set a URL destination for the Uri property:

1. Select the Uri row in the block's property table.
2. In the Value field, click the  button to open the Uri dialog box.
3. Select a file from the available projects.

Encoding Type Property

The Encoding Type property (used for callflows only) indicates the media encoding type of the submitted document. GVP 8.1 supports two encoding types:

- application/x-www-form-urlencoded
- multipart/form-data

To select a value for the Encoding Type property:

1. Select the **Encoding Type** row in the block's property table.
2. In the **Value** field, select **application/x-www-form-urlencoded** or **multipart/form-data** from the drop-down list.

Parameters Property

Note: Parameters cannot be entered until the Uri property is specified. Use the Parameters property to specify parameters to pass to the invoked backend JSP. To specify parameters:

1. Click the Parameters row in the block's property table.
2. Click the  button to open the Parameter Settings dialog box.

Add Button Use the Add button to enter parameter details.

1. Click **Add** to add an entry to Backend Parameters.
2. In the **Parameter Name** field, accept the default name or change it.
3. From the **Parameter Type** drop-down list, select **In**, **Out**, or **InOut**:

In	Input parameters are variables submitted to the Backend application.
Out	Output parameters are variables that the Backend application returns and will be reassigned back to the current callflow.

InOut

InOut parameters are parameters that act as both input and output.

4. In the **Expression** drop-down list, select from among the listed variables, type your own expression, or click the  button to use **Expression Builder**.
5. In the **Description** field, type a description for this parameter.
6. Click **Add** again to enter another parameter, or click OK to finish.

Delete Button To delete a parameter:

1. Select an entry from the list.
2. Click **Delete**.

Pass State Property

Note: This property is used for callflows only. The Pass State property Indicates whether or not to pass the application state to the backend. The application state includes all the variables shown in the Entry block as well as all variables containing returned values from user Input blocks. You can find Instructions on how to access these backend variables in [Creating a Backend JSP File](#) and [a Backend_ASP_.NET Creating a Backend ASP.NET File](#). The **Parameters** property can also be used to pass specific parameters into the backend and, for efficiency reasons, should be considered first. There is also a Cheat Sheet, [Creating a Backend Logic Block \(Help > Cheat Sheets > Composer > Building Voice Applications\)](#). To select a value for the Pass State property:

1. Select the **Pass State** row in the block's property table.
2. In the **Value** field, select **true** or **false** from the drop-down list.

Condition Property

Find this property's details under [Common Properties for Callflow Blocks](#) or [Common Properties for Workflow Blocks](#).

Logging Details Property

Find this property's details under [Common Properties for Callflow Blocks](#) or [Common Properties for Workflow Blocks](#).

Log Level Property

Find this property's details under [Common Properties for Callflow Blocks](#) or [Common Properties for](#)

[Workflow Blocks](#).

Enable Status Property

Find this property's details under [Common Properties for Callflow Blocks](#) or [Common Properties for Workflow Blocks](#).

ORS Extensions Property

Starting with 8.1.4, Composer blocks used to build routing applications (with the exception of the Disconnect and EndParallel blocks) add a new [ORS Extensions](#) property.

Business Rule Common Block

Business Rules

Composer interfaces with the Genesys Rules Engine, which is part of the [Genesys Rules System](#). A business rule is an external piece of business logic, which can be customized, and then invoked by Genesys applications. Here is an example business rule for a bank: IF product = 'mortgage' and loanAmount >=200000 THEN TTSMsg = 'You must have a credit score of 300 or great to qualify for this loan.' To simplify rule creation, the Genesys Rules System uses [Rule Templates](#). These are initially created by developers and IT professionals. A Composer-compatible plug-in is available for developing business Rule Templates. This plug-in is provided as part of the Genesys Rules System. For information on installing the plugin, refer to the *Genesys Rule System 8.1 Deployment Guide*. See Chapter 2, Installation. Once validated and deployed, Rule Templates are available for customization in the Genesys Rules Authoring Tool GUI. Business analysts then use the templates to create related sets of business rules called Rule Packages. Packaging rules together allows the business analyst to define which rules will support a particular application. You can use Composer's Business Rule block to request the Genesys Rules Engine to execute a [Rule Package](#) in a routing workflow or voice callflow and write the results back to a variable. A [business rule preference](#) specifies the Genesys Rules Authoring Tool server to work with. Find information on using the business rules GUI in the following documents:

- *Genesys Rules System 8.1 Deployment Guide*
- *Genesys Rules System 8.1 Rules Authoring Tool Help*
- *Genesys Rules System 8.1 Rules Development Tool Help*

Note: In the Genesys 8.1 release, the Genesys Rules System is packaged only with the intelligent Workload Distribution product and the Conversation Manager product.

Business_Rules_Preferences

The preferences entered here are used in the Business Rule block, [Business Rule Package property](#). To set Business Rules Preferences:

1. Select **Window > Preferences > Composer > Business Rules**.
2. Configure the connection to the Genesys Rules Authoring Tool (GRAT) server by entering the following fields:
 - **GRAT Server.** Enter the address of the Application server hosting the GRAT Server. When using the Business Rule Package property in the Business Rule block, Composer will connect to this server to query information about packages and rules. Example only: <http://ca-to-lennon:8080>.
 - **Server Path.** Enter the name of the web application deployed as the GRAT. For example, if you have the GRAT running at <http://ca-to-lennon:8080/genesys-rules-authoring>, then the

GRAT server is <http://ca-to-lennon:8080> and the Server Path is /genesys-rules-authoring.

- **Tenant.** To obtain a list of Rule Packages, Composer will query the GRAT server using an HTTP request to <http://{server-address:port}/tenant/packages>. Enter the name of the tenant as defined in the Configuration Database.
- **Username.** Enter the username defined in the Configuration Database for logging into the GRAT server.
- **Password.** Enter the password defined in the Configuration Database for logging into the GRAT server.
- **Genesys Rules Engine (Optional). GRE URL.** Enter the URL for the GVP Debugger to use when starting a call. The GRE URL will be passed to the VXML application in the SIP URL. If set, this value will be passed to the voice or routing application and will override the value set in the Rules Engine URL property of the [Business Rule Block](#) (see that section below).

Business Rule Templates

This functionality is enabled by an Eclipse plug-in that can be installed within Composer or in a standalone Eclipse environment.

- To install the plugin, refer to the *Genesys Rule System 8.1 Deployment Guide*. See Chapter 2, Installation.

The plug-in enables developers to create Rule Templates. Rule Templates consist of rule parameters, conditions, actions, and functions. When a Rule Template is published to the Rules System repository, it is made available to be added to Rule Packages. Rule Packages are the deployable objects, which are used to expose rule conditions and actions to business users for creating rules through the Genesys Rules Authoring tool. A brief summary of Rule Templates is presented below. For detailed information, see the *Genesys Rules System 8.1 Rules Development Tool Help*. Once you install the plugin, this help system is available within Composer by selecting **Help > Contents**.

Genesys Rules System Architecture

A logical view of the Genesys Rules System architecture is shown below.

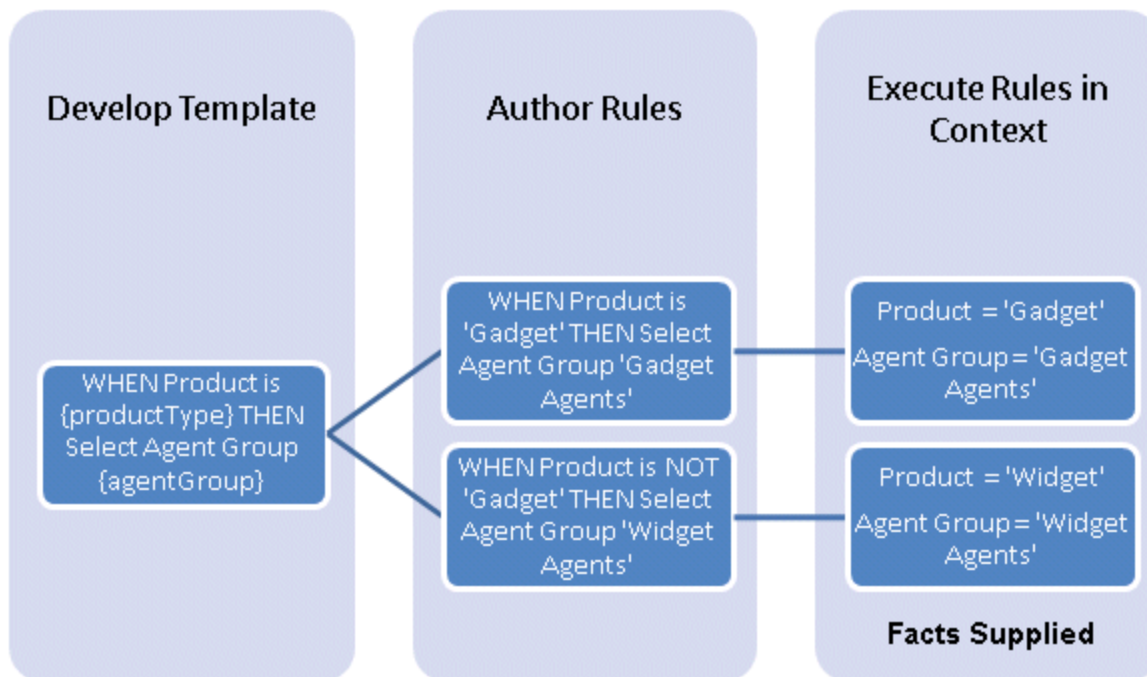

- The first category reflects Rule Template creation, which can be done in Composer if the set of plugins is installed.
- The second category reflects rule creation by business analysts in the Genesys Rules Authoring Tool.
- The third category reflects rule evaluation by the Genesys Rules Engine using the Business Rule block once the **Facts** are known.

Type of Rules

The Genesys Rules System supports both basic and decision table rules.

Basic Rule

A basic or linear business rule is of this form: WHEN {condition} THEN {action} In other words, when the condition is true, the action will occur. This is a rule template. When a business analyst uses the Genesys Rules Authoring Tool to customized a template with valid values, this creates a business rule. The following rules are all valid instances:

- WHEN Product = 'Gadget' THEN Select Agent Group 'Gadget Agents'
- WHEN Product = 'Widget' THEN Select Agent Group 'Widget Agents'
- WHEN Customer Segment = 'Gold' THEN Assign Credit Limit '200000'

This form of rule is preferred for simple actions, such as assigning a value to return back to the application.

Decision Table Rule

A business rule can also take form of a decision table. For example, assume in a particular scenario that there are 3 customer levels: Gold, Silver, and Bronze. For each of these levels, we wish to make an offer to customers based on a qualifying purchase they may have made. Gold customers automatically qualify for a Premium Offer. Silver customers need to have spent \$1000 or more to qualify for that offer, otherwise they get the Special Offer. Finally, Bronze customers need to have spent \$5000 or more for the Premium Offer; or \$2000 or more for the Special Offer; otherwise they are informed of the offers available if they make the qualifying purchase level. **Note:** The Genesys Rules Engine cannot execute Rule Templates.

Business Rule Block

See [Genesys Rules System](#) for information on using Composer to execute a rule block. Once the Rule Package (created from [Rule Templates](#)) that you want to work with are deployed to the Genesys Rules Engine, you can use the Business Rule block on the Server Side palette to create voice and routing applications that use business rules. Use this block to have Composer query the Genesys Rules Authoring Tool (GRAT) for deployed packages. For the Rule Package that you specify, Composer will query the GRAT for the Facts associated with the Rule Package. You can then set values for the Facts, call the Genesys Rules Engine for evaluation, and save the results in a variable. **Note:** This last step (evaluation) happens as part of a VXML or SCXML application that Composer developer creates, not as part of Composer. A [business rule preference](#) specifies the Genesys Rules Engine to work with. **Runtime Parameters** The following parameters (defined in Preferences) are used at runtime, when the VXML and SCXML application queries the GRAT to execute the rule.

- grat_username -- a user login for accessing the GRAT server
- grat_password -- the password for the above login
- grat_server -- a URL for the GRAT server, for example: <http://hostname:8080/genesys-rules-authoring>
- grat_tenant -- the tenant associated with the login, e.g. Environment

The Business Rule block has the following properties:

Name Property

Find this property's details under [Common Properties for Callflow Blocks](#) or [Common Properties for Workflow Blocks](#).

Block Notes Property

Find this property's details under [Common Properties for Callflow Blocks](#) or [Common Properties for Workflow Blocks](#).

Business Rule Package Property

Use to select the Rule Package (collection of related rules) you would like to execute. Packaging rules together allows the business analyst to define which rules will support a particular application. Before using this property, you must set Business Rules Preferences.

1. Click the  button to request Composer to connect to the Genesys Rules Authoring Tool Server using the information specified in **Business Rule Preferences**. After a successful connection, the Business Rule Package dialog appears.
2. Select a Rule Package and click **OK**. The dialog closes and the name of the Rule Package appears under Value.

Facts Property

Use this property to execute the logic contained in the selected Rule Package by supplying input parameters called *Facts*. To specify Facts:

1. Click the **Facts** row in the block's property table.
2. Click the  button to open the Facts dialog box.
3. Click **Add**. The dialog box adds additional fields consisting of the Facts to use when executing the Rule Package. You then click the down arrow and select a value or a variable that contains the value for each Fact. An example dialog box is shown below.

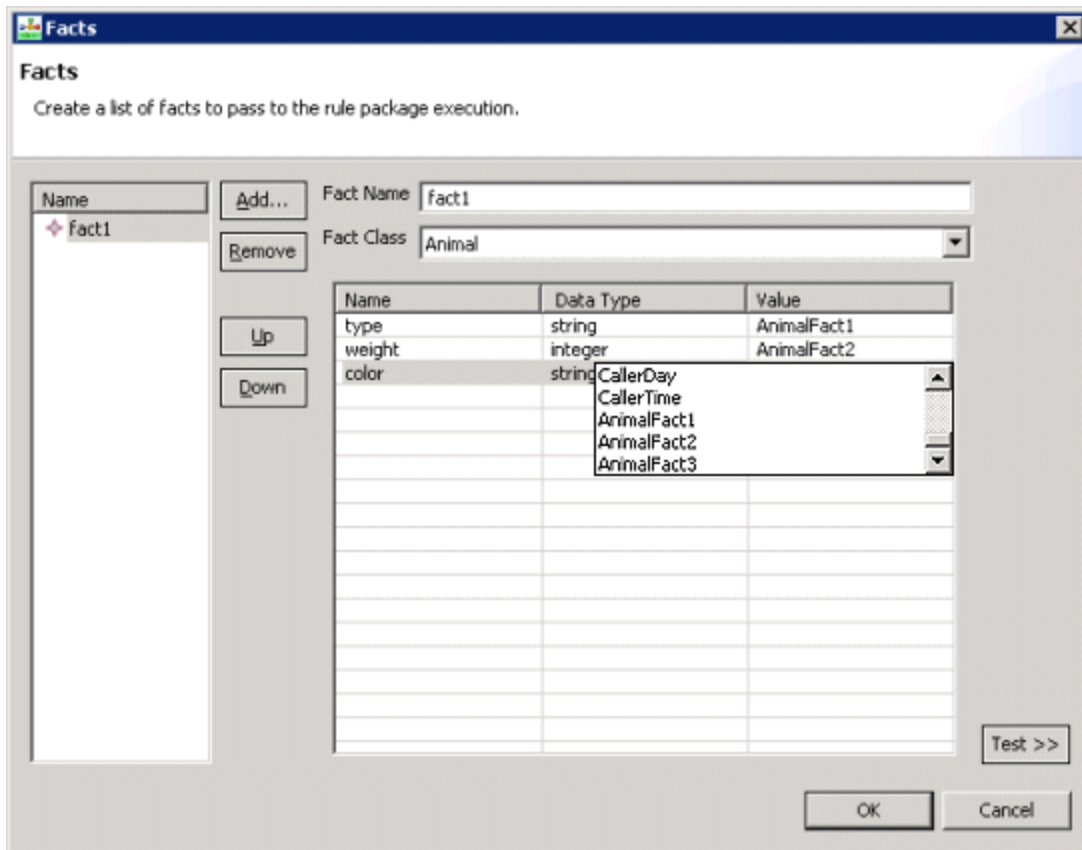

Facts.gif

4. Enter the **Fact Name** field.
5. Click the down arrow and select an entry for the **Fact Class** field.
6. Click the down arrow and select a value or a variable that contains the Fact value.
7. Click **Add** again to enter another Fact, or click **OK** to finish.

Delete Button To delete a Fact:

1. Select an entry from the list.
2. Click **Delete**.

Rules Engine URL

Select the variable containing the Genesys Rules Engine URL. Background: Starting with 8.1.2, Composer-generated applications no longer interact with the GRAT server at runtime. Previous requests to the GRAT Server were done to retrieve the URL of the GRE server to which a rules package is deployed. Instead, the runtime applications now use the Rules Engine URL property, which is passed into the application via the IVR Profile or an Enhanced Routing Script object. You can use this Rules Engine URL property to override any GRE URL configured in the IVR Profile or

EnhancedRouting Script object.

Starting with Composer 8.1.440.18, you can specify a variable when the **Use Variable** option is selected.

This can be used for testing in complex deployments where, for example, the GRE load balancer (or respective instances) is not accessible from the network zone where Composer is located. This option provides the possibility to configure the URL for testing the Rules.

Exceptions Property

The Business Rule block supports the following exceptions. They correspond to the HTTP status codes returned by the Business Rule Server (BRS).

Exception Event Name	HTTP Return Code	BRS Error Code	Description
error.com.genesyslab.com:400	400.badrequest	610	The received URI does not match the Engines REST specification.
error.com.genesyslab.com:404	404.notfound	620	The package for the evaluation request received was not found.

error.badfetch.http			Any other HTTP error.
error.com.genesyslab.composer.notacceptable	606	602	The evaluation request received could not be converted to a valid knowledgebase-request message, or the evaluation request received could not be evaluated due to an exception.

Details of the exception can be obtained from the body of the response. The Composer application will log the description. The JSON body of the response will look like the following:

```
{  error:{      code:6xx,      description:error message  } }
```

Also see [Common Properties for Callflow Blocks](#) or [Common Properties for Workflow Blocks](#).

Condition Property

Find this property's details under [Common Properties for Callflow Blocks](#) or [Common Properties for Workflow Blocks](#).

Logging Details Property

Find this property's details under [Common Properties for Callflow Blocks](#) or [Common Properties for Workflow Blocks](#).

Log Level Property

Find this property's details under [Common Properties for Callflow Blocks](#) or [Common Properties for Workflow Blocks](#).

Enable Status Property

Find this property's details under [Common Properties for Callflow Blocks](#) or [Common Properties for Workflow Blocks](#).

Interaction ID Property

Set to a meaningful value or keep the default value, which is the system variable InteractionId. Applicable to workflows only. Can be used for "interaction-less" processing for scenarios where the

InteractionId variable is not automatically initialized, but instead must wait for an event. An example would be an SCXML application triggered by a Web Service that does not add an interaction. Background: Previous to 8.1.1, Composer did not expose an Interaction ID property. Instead, when ORS started processing an interaction, a generated SCXML application automatically initialized the system variable, InteractionId. This variable was then used internally by Routing and certain eServices blocks when interacting with ORS. With the introduction of support for Interaction-less processing, you can now define a specific event (**IPD Events property**) to initialize InteractionId, or not define an event at all. For scenarios with an interaction (IPD Diagram/Wait For Event=interaction.present for example), you may keep the default value for the Interaction ID property. The default value is the system variable InteractionId, which is initialized automatically in this case. For other scenarios (any scenario where the system variable InteractionId is not set), you may choose to:

1. Not use blocks that require an Interaction ID
2. And/or set the Interaction ID property to a meaningful value
3. And/or assign a meaningful value to the InteractionId system variable

Output Result Property

Use this property to save the results of the business rule execution to a variable. To select a variable:

1. Select the **Output Result** row in the block's property table.
2. In the Value field, select one of the available variables from the drop-down list. Does not need to match the variable name that is coming back as a result of the web request.

The format of returned data is JSON. Any post-processing work to be done on returned results can be done in the existing **Assign block** which provides access to ECMAScript functions. It supports writing simple or complex expressions to extract values out of JSON strings and arrays. In a workflow, the Output Result can be attached to User Data. In the Specify Output Result Location dialog box, select User Data or Variable. If User Data is selected, the specified name is used as a prefix of the keys that will be added to user data. For example, if you specify abc, then the User Data will look like:

```
'abc_fact1'(list) '@class'      'com.genesyslab.animals.Animal'
                    'color'      'red'
                    'type'       1903
                    'weight'    123
                    'abc_fact2'(list)
 '@class'      com.genesyslab.animals.Car'      'make'
                    'mazda'
```

Note: The Output Result property takes effect only during application runtime. Its purpose is to take the output of the rule execution (at runtime) and store returned results back in the specified application variable so other parts of the application can access the data.

Business Rules Block Runtime Configuration

The table below shows the parameters that must be set up in Genesys Administrator in order for the Business Rules block to work.

	ERS Object Key Names	IVRprofile Object Key Names
GRS	grat_server	grat_server
	grat_tenant	grat_tenant
	grat_username	grat_username
	grat_password	grat_password

The figure below shows an example Enhanced Routing Script object created by Composer. It creates these parameters in the ApplicationParms section in the Annex, so you do not have to key in parameter names. Note: If you accidentally changes parameter names, these functions will not work.

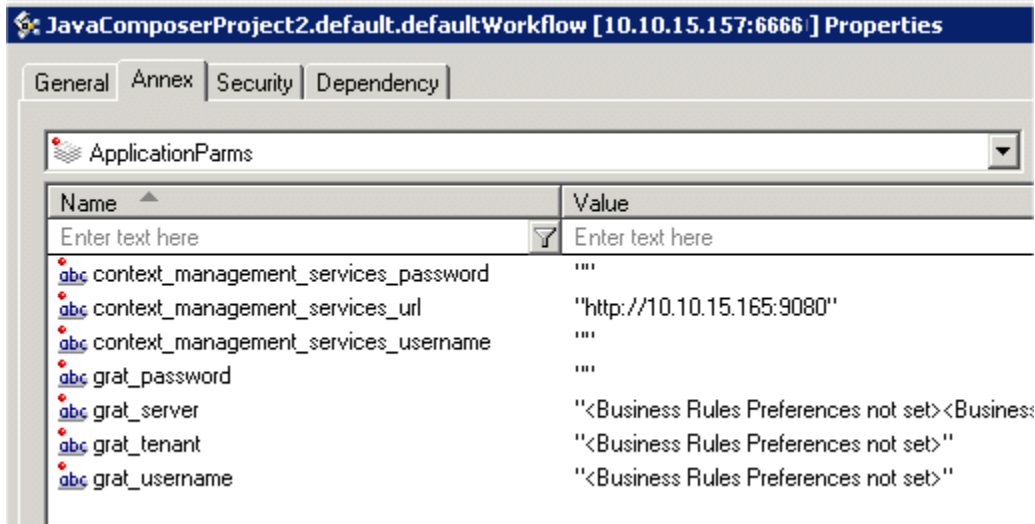

Working With Returned Data

Below is an example on how to work with data returned by the Business Rules block. A sample of the output can look like the snippet below, which will be stored in the output variable myOutputVar.

```
myOutputVar = '{  
  'knowledgebase-response':{  
    inOutFacts:{  
      named-fact:[{  
        fact:{  
          '@class':"abc.sample2._GRS_Environment",  
          businessContext__Level1:"Raleigh",  
          phase:"prioritization"  
        },  
        id:"environment"  
      },  
      {  
        fact:{  
          '@class':"abc.sample2.Caller",  
          disposition:true  
        },  
        id:"ourCaller"  
      }  
    ]  
  }  
}'  
}}}}
```

To extract the value of the disposition field, an expression like this can be used:
`myDisposition = myOutputVar["knowledgebase-response"].inOutFacts["named-fact"][1].fact.disposition`
This will return true.

ORS Extensions Property

Starting with 8.1.4, Composer blocks used to build routing applications (with the exception of the Disconnect and EndParallel blocks) add a new **ORS Extensions** property.

DB Data Common Block

The DB Data block is available for both routing and voice applications. Use for connecting to a database and retrieving/manipulating information from/in a database. This block uses a [connection profile](#) to read database access information. It accepts a SQL query or a Stored Procedure call, which can be defined using the [Using the Query Builder](#) or [Stored Procedure Helper](#). It can also use a SQL script file. **Note:** When using the DB Data block to connect to and query information from an Oracle database, some connections may remain in the TIME_WAIT state. If you encounter this situation, use [connection pooling](#) in order to avoid exhausting the number of allowed Oracle connections. This block acts as a data source for the [DB Prompt](#) and [DB Input](#) blocks (available only in callflows). An Entry block user variable can also be used to access the results of a Stored Procedure call specified in a DB Data block for both voice and routing applications.

Important

The [Looping block](#) can work with the DB Data block. For example, you can use the Looping block to iterate over a data set returned by the DB Data block to map values returned from a database query to application variables.

Manually Configuring Context Attributes for Memory Leaks

At times, possible memory leaks can occur in Tomcat when the DB Data block is used in a strategy. To avoid these possible leaks during runtime, set the following context attributes in the **context.xml** file (<tomcat-folder>/conf/context.xml) to true:

- clearReferencesStopThreads
- clearReferencesStopTimerThreads
- clearReferencesThreadLocals

Example:

```
<!-- The contents of this file will be loaded for each web application -->
<Context clearReferencesStopThreads="true" clearReferencesStopTimerThreads="true"
clearReferencesThreadLocals="true">
<!-- Default set of monitored resources. If one of these changes, the -->
<!-- web application will be reloaded. -->
<WatchedResource>WEB-INF/web.xml</WatchedResource>
<WatchedResource>${catalina.base}/conf/web.xml</WatchedResource>
<!-- Uncomment this to disable session persistence across Tomcat restarts -->
<!--
<Manager pathname="" />
-->
</Context>
```

Also see: [Working with Database Blocks](#). The DB Data block has the following properties:

Name Property

Find this property's details under [Common Properties for Callflow Blocks](#) or [Common Properties for Workflow Blocks](#). **Note:** If you rename a DB Data block, its corresponding SQL statement file in the db folder will not be updated and will not be valid until you generate code again.

Block Notes Property

Find this property's details under [Common Properties for Callflow Blocks](#) or [Common Properties for Workflow Blocks](#).

Connection Profile Property

The Connection Profile property allows you to select a previously-created database [Database Connection Profiles](#) that specifies database details for this DB Data block. If you have not created a connection profile, open the Connections Profile editor as follows:

1. Under **Value**, click the down arrow.
2. Select **Create New Profile Using Editor...**

Refer to the topic [Database Connection Profiles](#) for instructions. To select a connection profile for your database query:

1. Select the **Connection Profile** row in the block's property table.
2. Select the connection profile to use for this query.

Connection Properties Property

The Connection Properties property allows you to override the parameters in connection profile during runtime. The properties that can be overridden are Hostname, Password, Port, Database, Username and other Custom Parameters. Variable mapping can be configured in the dialog box provided for the property. To define the variable mapping for Connection Parameters:

1. Click the  button to open the Connection Properties variable mapping dialog.
2. Dialog displays the parameter name and value in connection profile. Select the system variable in the drop down combo against each property.
3. Click OK

Connection String Property

The Connection String Property allows you to define the value of Connection String that need to be used at Runtime. If this property is specified, the parameters from Connection Profile is ignored. To define this property enter either literal value or select system variable from the combo provided for the property.

Timeout Property

The Timeout property defines the length of time in seconds that the voice application will wait for query execution to complete. To provide a timeout value:

1. **Select the** Timeout row in the block's property table.
2. In the Value field, type a timeout value, in seconds.

The default value (20 seconds) of this property is used if not specified explicitly. Disable the timeout by setting to -1. If the query takes longer than this specified time to complete the `error.com.genesyslab.composer.dbtimeout` exception is thrown. In order to select a query type, the Connection Profile property must be set.

Query Type Property

To define a query type:

1. Select the **Operation Type** row in the block's property table.
2. Select one of the following:
 - **SQLQuery**
 - **SQLScriptFile**
 - **StoredProcedure**

Based on the value selected for **Operation Type**, the specified value is used and some properties are not used.

Query Property

The Query property opens the Query Builder in which you can visually build the database query.

Note: The Query property and Query File property are mutually exclusive. If both are entered, then the Query File property takes precedence over the query defined in the Query property. To define a query:

1. Select the **Query** row in the block's property table.
-

2. Click the  button to open the [Query Builder](#).

Important

When specifying integers (or constants) in SQL queries, enclose them within single quotes (e.g. '0123') in the DB data block

Query File Property

The Query File property accepts a filename that points to a SQL file that the user has written. To provide a filename for a user-written SQL file:

1. Select the **Query File** row in the block's property table.
2. In the Value field, type the filename of the SQL file (the file is usually in the db folder of your project. If it is present in a different location, specify a relative path, such as `./myfolder/myquery.sql`).

Stored Procedure Property

The Stored Procedure property opens the Stored Procedure Helper in which you can visually build the database query. To define a stored procedure call:

1. Select the **Stored Procedure** row in the block's property table.
2. Click the  button to open the [Stored Procedure Helper](#).

Column Names Variable Property

The Column Names Variable property maps the list of column names in the result to the specified variable. The default is Use system default, in which case the system uses an internal variable which is named in the format below. Genesys recommends that you define a user variable for this purpose in the Entry block and specify it in the DBData block. For Callflow diagrams:
AppState.<blockname>DBResultColumnsNames For Workflow diagrams:
App_<blockname>['DBResultColumnsNames'] To select a variable:

1. Select the **Column Names Variable** row in the block's property table.
2. In the **Value** field, select the variable from the dropdown list.

Records Variable Property

The Records Variable property maps the records (data) in the result set to the specified variable. The default value is Use system default, in which case the system creates an internal variable which is named in the format below. However, Genesys recommends that you specify a user variable in the Entry block. For Callflow diagrams: AppState.<blockname>DBResult For Workflow diagrams: App_<blockname>['DBResult'] To select a variable:

1. Select the **Records Variable** row in the block's property table.
2. In the **Value** field, select the variable from the dropdown list.

Note: The following applies to all methods of getting database results (query builder, stored procedure helper, custom queries): Results are stored in a variable as a two-dimensional JSON array. This data can then be accessed via a [Looping block](#) or via scripting in the [Assign](#) or [ECMAScript block](#). For example, if the database result set looks like this in tabular form:

Vegetables	Animals
lettuce	chicken
broccoli	lion

The JSON for the result will look like this: {"db_result":[[{"lettuce", "chicken"}, {"broccoli", "lion"}], "db_result_columns":["vegetables", "animals"]}

Suppress Empty Result Set Exception Property

The Suppress Empty Result Set Exception property determines if the dbemptyresultset exception should be thrown if a query or a stored procedure execution results in an empty result set (number of records returned is zero). To provide a value:

1. Select the **Suppress Empty Result Set Exception** row in the block's property table.
2. Select **true** or false.

Exceptions Property

Find this property's details under [Common Properties for voice blocks](#) or [Common Properties for Workflow Blocks](#). The Exceptions dialog box for the DB Data block has the following exception events:

- error.com.genesyslab.composer.dbconnectionerror
- error.com.genesyslab.composer.dberror (pre-selected in the Supported column)
- error.com.genesyslab.composer.dbemptyresultset (pre-selected in the Supported column)
- error.com.genesyslab.composer.dbtimeout

Condition Property

Find this property's details under [Common Properties for Callflow Blocks](#) or [Common Properties for Workflow Blocks](#).

Logging Details Property

Find this property's details under [Common Properties for Callflow Blocks](#) or [Common Properties for Workflow Blocks](#).

Log Level Property

Find this property's details under [Common Properties for Callflow Blocks](#) or [Common Properties for Workflow Blocks](#).

Enable Status Property

Find this property's details under [Common Properties for Callflow Blocks](#) or [Common Properties for Workflow Blocks](#).

ORS Extensions Property

Starting with 8.1.4, Composer blocks used to build routing applications (with the exception of the Disconnect and EndParallel blocks) add a new [ORS Extensions](#) property.

External Service Block

This block enables routing applications to invoke methods on third party servers that comply with Genesys Interaction Server (GIS) protocol. Use to exchange data with third party (non-Genesys) servers that use the [Genesys Interaction SDK](#) or any other server or application that complies with the GIS communication protocol. Can be used for both voice and non-voice interactions.

Important

In order to use this object, the third party server/application must already be defined in the [Configuration Database](#) as a server of type Third Party Server or Third Party Application. Before completing the External Service block properties, you must already know the names of Services, Methods, and Signatures (requested input/output parameters) provided by the external service.

The Composer External Service block does not automatically pass user data in the ESP call unlike the legacy IRD External Service object. Therefore, ESP methods that expect user data cannot be called using this block. Please refer to the [ESP method/API](#) documentation to determine if user data is required. To call an ESP API that requires user data, a hand coded SCXML page can be used and invoked using the SubRoutine block. Please refer to the <session:fetch> documentation in the [Orchestration Server Developers Guide](#). See Action Elements under [Session Interface](#) for details on how to pass user data in ESP requests.

Use Case

A customer has a custom integration to a third party application (a workflow system), through the [Open Media API](#). The workflow system uses Genesys to distribute work items at various times during the workflow. At some point in the IPD handling a work item, there is a need to update the workflow system and assign a new value to one of the attributes of the work item. The Genesys developer has the IPD call a routing strategy, which uses the External Service block to call a specific method exposed by the third party application. This allows the developer to update the value of the specific attribute of the work item. The External Service block has the following properties:

Name Property

Find this property's details under [Common Properties for Callflow Blocks](#) or [Common Properties for Workflow Blocks](#).

Block Notes Property

Find this property's details under [Common Properties for Callflow Blocks](#) or [Common Properties for Workflow Blocks](#).

Exceptions Property

Find this property's details under [Common Properties for Callflow Blocks](#) or [Common Properties for Workflow Blocks](#). You can also define [custom events](#).

Application Property

Use this property to select the name of the third party application to be contacted or the general Application type to be contacted, which must be defined in the Configuration Database. Starting with 8.1.410.14, you can select **Social Messaging Server** in the dialog. If a [Social Messaging Server](#) was configured as a Third Party Server in the Configuration Database, then it will be listed inside the **Third Party Server** category.

1. Click under **Value** to display the  button.
2. Click the button to open the Application Selection dialog box.
3. Select the third party application to be contacted.
4. Click **OK**.

Include Interaction User Data

Select true or false to indicate whether to attach all interaction user data to request's udata parameter.

Method Name Property



Use this property to specify the Method defined by the third party server or application.

1. Click under **Value** to display the  button.
2. Click the button to open the Method Name dialog box.
3. Opposite **Type**, select one of the following as the source for the name:
 - **Literal** to enter the method name manually in the Value field.
 - **Variable** to select a variable for the method name in the Value field.

4. Click **OK** to close the dialog box.

Method Parameters Property

Use this property to specify the list of input parameters to be passed to the specified external service. Click the button to add a new entry:

1. Click under **Value** to display the  button.
2. Click the  button to open the Method Parameters dialog box.
3. Click **Add** to open the Select Items dialog box.
4. Opposite **Key**, leave **Literal** in the first field and enter the input parameter name in the second field.
5. Opposite **Value**, click the down arrow and select either literal or variable.
 - If you select **Literal**, enter the name of the key in the second field.
 - If you select **Variable**, select the name of the variable from the second field.
6. Click **OK** to close the Select Items dialog box. The Method Parameters dialog box shows your entry.
7. Continue adding parameters in this fashion.
8. Click **OK** when through in the Method Parameters dialog box. .

Service Name Property

Use this property to specify the name of the Service defined by the third party server or application for the functionality requested.

1. Click under **Value** to display the  button.
2. Click the button to open the Service Name dialog box.
3. Opposite **Type**, select one of the following as the source for the name:
 - **Literal** to enter the service name manually in the Value field.
 - **Variable** to select a variable for the service name in the Value field.
4. Click **OK** to close the dialog box.



Service Timeout Property

Use this property to specify the timeout in seconds (s) to be used for invoking this method. If not checked, URS uses the Reconnect Timeout entered for third party server or application in Configuration Server. In the case of a connection or service request failure, error codes are returned.

The default is 30 seconds.

User Data Property

Use this property to specify the list of User Data parameters to be passed to the specified external service. Click the button to add a new entry:

1. Click under **Value** to display the  button.
2. Click the  button to open the User Data dialog box.
3. Click **Add** to open the Select Items dialog box.
4. Opposite Key, leave Literal in the first field and enter the input parameter name in the second field.
5. Opposite **Value**, click the down arrow and select either literal or variable.
 - If you select **Literal**, enter the name of the key in the second field.
 - If you select **Variable**, select the name of the variable from the second field.
6. Click **OK** to close the Select Items dialog box. The User Data dialog box shows your entry.
7. Continue adding parameters in this fashion.
8. Click **OK** when through in the User Data dialog box.

Result Property

Use this property to specify an application variable to store the results. These results will then be available in other blocks in the application for further processing. The format of returned data is JSON. Any post processing work to be done on returned results can be done in the existing **Assign block** which provides access to ECMAScript functions. It already supports writing simple or complex expressions to extract values out of JSON strings and arrays.

Condition Property

Find this property's details under [Common Properties for Callflow Blocks](#) or [Common Properties for Workflow Blocks](#).

Logging Details Property

Find this property's details under [Common Properties for Callflow Blocks](#) or [Common Properties for Workflow Blocks](#).

Log Level Property

Find this property's details under [Common Properties for Callflow Blocks](#) or [Common Properties for Workflow Blocks](#).

Enable Status Property

Find this property's details under [Common Properties for Callflow Blocks](#) or [Common Properties for Workflow Blocks](#).

ORS Extensions Property

Starting with 8.1.4, Composer blocks used to build routing applications (with the exception of the Disconnect and EndParallel blocks) add a new [ORS Extensions](#) property.

NDM Block

Starting with Composer release 8.1.410.14, callflow diagrams add an NDM block to work with **Nuance** OSDM 6.1 modules used for speech and touch-tone IVR applications. The NDM block, available on the Server-Side palette, lets you choose the OSDM modules and parameters to work with the selected module.

Note: Composer has a template Project that uses Subdialog blocks to invoke OSDM modules. This new block provides in-built support to work with OSDM modules.

Global Properties

Set the `com.genesyslab.dtmf.offboard_recognition` property to true in the **Entry Block -> Global** properties. For more information on the DTMF Recognizer property, click [here](#).

Name Property

Find this property's details under [Common Properties for Callflow Blocks](#).

Block Notes Property

Can be used to add comments to both callflow and workflow blocks.

Dm Name Property

Click the down arrow and select a variable containing the Dialog Module name. Or select from the dropdown list in the **Module Name** property.

Module Name Property

Click the down arrow and select one of the **Nuance** module names.

Osdm Url Property

Enter the base URL that points to the server for the Nuance OpenSpeech DialogModules. Format: String (http://ip:port/ndm-core).

Exceptions Property

The NDM Input block has one supported exception event:

- `error.ndm.modulefailed`. If the return code is not SUCCESS, this error will be thrown.

Condition Property

Find this property's details under [Common Properties for Callflow Blocks](#).

Logging Details Property

Find this property's details under [Common Properties for Callflow Blocks](#).

Log Level Property

Find this property's details under [Common Properties for Callflow Blocks](#).

Output Result Property

You must use the **Output Result** property to assign the collected data to a user-defined **variable** for further processing.



Important

Note! This property is mandatory. You must select a variable for the output result even if you do not plan on using the variable. If this is not done, a validation error will be generated in the **Problems** view.

1. Select the **Output Result** row in the block's property table.
2. In the **Value** field, click the down arrow and select a variable.

Input Parameters Property

Use the this property to specify input parameters to pass to the invoked sub-workflow. To specify parameters:

1. Click the **Input Parameters** row under **Value**.
2. Click the  button to open the **NDM Input Parameters** dialog box.
3. Click the **Add** button to enter parameter details.
4. In the **Parameter** field, accept the default name or change it.
5. From the **Type** drop-down list, leave input.
6. From the **Expression** field, click the  button to use **Expression Builder** where you can define an expression for the input parameter(s) or select a variable containing the expression (**Callflow Variables > Input**).
7. Set the "browser" parameter to genesys. This is optional but helpful as this parameter directs the engine to match the Voice Platform type.
8. In the **Description** field, type a description for this parameter.
9. Click **Add** again to enter another parameter, or click **OK** to finish.

Security Property

When the **Security** property is set to true, data for this block is treated as private. GVP will consider the data associated with this block as sensitive and will suppress it in platform logs and metrics. To assign a value to the **Security** property:

1. Select the **Security** row in the block's property table.
2. In the **Value** field, select true or false from the drop-down list.

Enable Status Property

Find this property's details under [Common Properties for Callflow Blocks](#).

Example Diagram

An example callflow diagram using the NDM block is shown below.

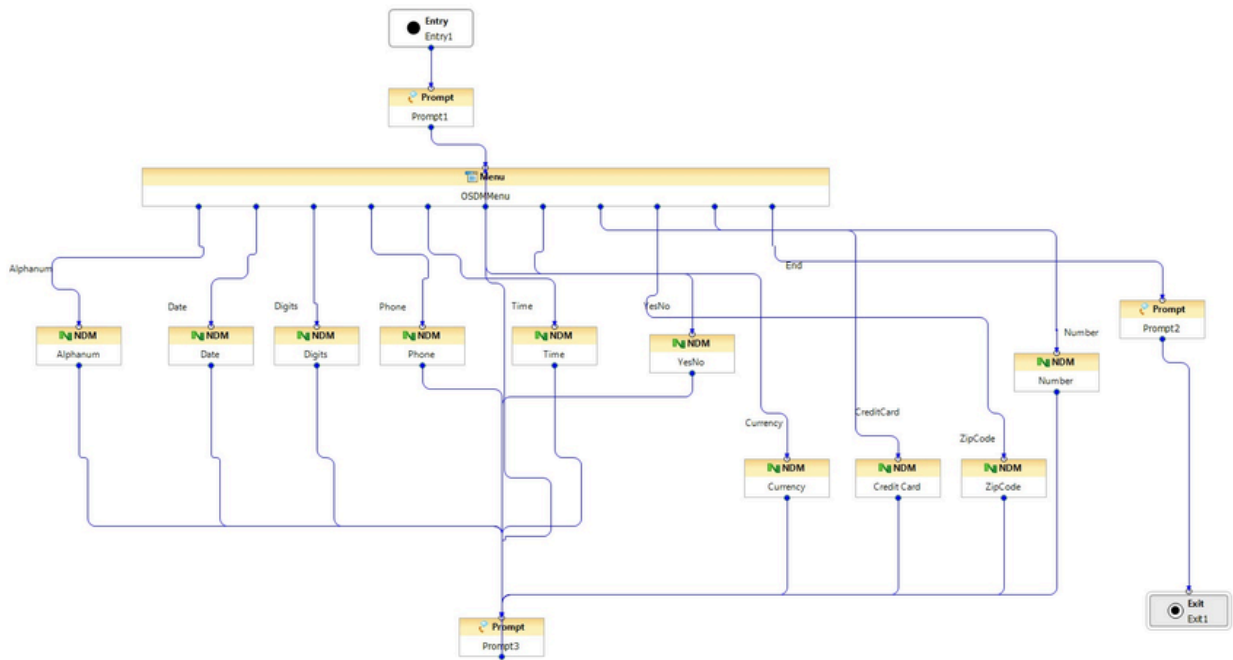

HTTP Rest Block

A new block, HTTP Rest, is introduced in 8.1.450.08. The HTTP Rest block can be used in both routing and voice applications.

In routing applications, the HTTP Rest block supports the native HTTP Fetch functionality in Orchestration Server and uses the ORS SCXML <session:fetch> element to fetch arbitrary XML and JSON data from a server. The data fetched by the <session:fetch> element is bound to an ECMAScript object through a named variable.

In voice applications, the HTTP Rest block supports the native HTTP Fetch functionality in GVP and uses the GVP VoiceXML <data> element to fetch arbitrary XML and JSON data from a document server. The data fetched by the <data> element is bound to an ECMAScript object through a named variable.

The HTTP Rest block has the following properties:

Name Property

Find this property's details under [Common Properties for Workflow Blocks](#) or [Common Properties for Callflow Blocks](#).

Block Notes Property

Find this property's details under [Common Properties for Workflow Blocks](#) or [Common Properties for Callflow Blocks](#).

Exceptions Property

Find this property's details under [Common Properties for Workflow Blocks](#) or [Common Properties for Callflow Blocks](#). You can also define [custom events](#).

The Web Service block Exceptions dialog box has the following pre-set exceptions:

- Callflows: `error.badfetch`, `error.semantic`, and `error`.
- Workflows: `error.session.fetch`, `error.script`, and `error`.

Guarantee HTTP Execution Property

Use this property (applicable for workflows only) to indicate whether the platform can guarantee the execution of the <fetch> action.

1. Select the **Guarantee HTTP Execution** row in the block's property table.
2. In the **Value** field, select **true** or **false**.

Retries Property

Specify an integer value in this property (applicable for workflows only) to indicate the number of times the platform will try to successfully deliver the associated HTTP request to the defined destination.

Retry Interval Property

Specify an integer value in this property (applicable for workflows only) to indicate the number of seconds to wait between each retry.

User Name Property

Specify the user name for HTTP basic authentication through a literal or a variable.

Important

When trying to access an anonymous HTTP URL, you need not provide any user credentials.

Password Property

Specify the password for the user name specified in the User Name property for HTTP basic authentication, through a literal or a variable.

Uri Property

Use this property to specify the URL destination or location of the XML and JSON data to retrieve.

1. Select the **Uri** row in the block's property table.
2. In the **Value** field, click the down arrow and select the variable that contains the URL or specify the URL (literal).

Condition Property

Find this property's details under [Common Properties for Callflow Blocks](#) or [Common Properties for Workflow Blocks](#).

Logging Details Property

Find this property's details under [Common Properties for Callflow Blocks](#) or [Common Properties for Workflow Blocks](#).

Log Level Property

Find this property's details under [Common Properties for Callflow Blocks](#) or [Common Properties for Workflow Blocks](#).

ORS Extensions Property

Use this property to add custom attributes into any/all states and sub-states for any block they are configured in. For more information on this property, see [ORS Extensions](#).

Input Parameters Property

Use the **Input Parameters** property to specify a list of required Name/Value pairs to pass as parameters to the http:// page. To specify input parameters:

1. Click the Input Parameters row in the block's property table.
2. Click the ... button to open the Input Parameters dialog box.

Add Button

Use the **Add** button to enter parameter details.

1. Click **Add** to add a parameter.
2. In the **Parameter Name** field, leave the default name as is or change as required.

3. The **Parameter Type** field displays **input** to indicate that the parameter being defined is an input parameter
4. In the **Expression** field, click the ... button to use the **Expression Builder**.
5. In the **Description** field, type a description for the parameter.
6. Click **Add** again to enter another parameter, or click **OK** to finish.

Important

To reorder the priority of the input parameters, use the **Up** and **Down** buttons to rearrange the parameters as desired in the dialog box.

Remove Button

To remove a parameter:

1. Select an entry from the list.
2. Click **Remove**.

JSON Payload Property

Select the appropriate variable from the **Value** drop-down to specify the JSON object that will be sent for requesting data.

Use JSON Payload Property

Use this property to specify if parameters must be sent individually or collectively as an object.

1. Select the **Use JSON Payload** row in the block's property table.
2. In the **Value** field, select **true** or **false**.

Encoding Type Property

The Encoding Type property indicates the media encoding type of the submitted document.

GVP supports the following encoding types:

- application/x-www-form-urlencoded
- application/json
- multipart/form-data

ORS supports the following encoding types:

- application/x-www-form-urlencoded
- application/json

To select a value for the **Encoding Type** property:

1. Select the **Encoding Type** row in the block's property table.
2. In the **Value** field, select the required value or specify a literal value.

Request Method Property

This property indicates the method for invoking the web request:

- **get** - Invoked using HTTP Get.
- **post** - Invoked using HTTP Post.
- **put** - Invoked using HTTP Put.
- **delete** - Invoked using HTTP Delete.

To specify a value for the Request Method property:

1. Select the **Request Method** row in the block's property table.
2. In the **Value** field, specify or select **get**, **post**, **put**, or **delete** from the drop-down list.

Important

When the HTTP Rest block is used in a callflow, the value specified in this property is not case sensitive.

Custom HTTP Headers Property

Use this property (applicable for workflows only) to add Custom HTTP headers to be sent along with the HTTP request during runtime execution of the Server Side block.

1. Click the **Custom HTTP Headers** row in the block's property table.
2. Click the **...** button to open the Custom HTTP Headers dialog box.
3. Click **Add** to add a header entry.
4. Select the required variable that contains the header from the **Value** drop-down or specify a literal value.

Max Age Property

Use this property to specify the maximum duration (as an integer) for which the cached copy of the retrieved data is considered, in seconds.

Max Stale Property

Use this property to specify the maximum duration (as an integer) for which the cached copy of the retrieved data is considered after expiration, in seconds.

Timeout Property

Use this property (applicable for workflows only) to specify the duration in seconds (as an integer) before throwing a timeout error and sending the `.session.fetch` event when the content is not returned.

Fetch Data Type Property

Use this property (applicable for workflows only) to select the type of data that will be retrieved by the `<fetch>` action. The following data types are supported:

- **JSON**
- **application/xml**

1. Click the **Fetch Data Type** row in the block's property table.
2. Select the required fetch data type from the **Value** drop-down.

Fetch Audio Property

Use this property (applicable for callflows only) to specify the URI of the audio to play while waiting for the data to be retrieved.

Fetch Audio Delay Property

Use this property (applicable for callflows only) to specify the time in seconds (as an integer) to wait before playing the retrieved audio.

Fetch Audio Minimum Property

Use this property (applicable for callflows only) to specify the minimum duration (as an integer) for which the retrieved audio must be played after being triggered.

Fetch Hint Property

Use this property (applicable for callflows only) to select when the audio content must be retrieved from the server.

- `safe` - file is downloaded only when needed.

Fetch Timeout Property

Use this property (applicable for callflows only) to specify the duration in seconds (as an integer) before throwing a timeout error and sending the `error.badfetch` event when content is not returned.

Output Result

Select one of the available variables from the drop-down to indicate the variable that will contain the result of the `<fetch>` request.

Response Headers

Use this property (applicable for workflows only) to indicate the variable that will contain the response headers for the HTTP request.

Response Status

Select one of the available variables from the drop-down to indicate the variable that will contain the response output status of the HTTP request.

Status Code

Select one of the available variables from the drop-down to indicate the variable that will contain the

output status code of the HTTP request.

Important

If any errors are encountered, the status code is updated only if the block handles exceptions.

Enable Status

Find this property's details under [Common Properties for Callflow Blocks](#) or [Common Properties for Workflow Blocks](#).

[+] HTTP Rest Workflow Block Code Sample

```
<state id="HTTPRest1">
  <onentry>
    <log expr="_sessionid + ': Inside HTTPRest Block: HTTPRest1'" />
    <session:fetch requestid="App_HTTPRest1['requestid']"
      srcexpr="user_uri" method="get" enctype="application/x-www-form-
urlencoded" username="username" password="password" maxage="40" maxstale="80"
type="application/json" gdelivery="false" gd_retries="1" gd_retry_interval="0" timeout="60">
    </session:fetch>
  </onentry>
  <transition event="session.fetch.done"
cond="_event.data.requestid==App_HTTPRest1['requestid']" target="$$_MY_PREFIX_$$_Exit1">
    <log expr="'Session FETCH DONE'" />
    <log expr="'Composer Application:subroutine Block:
HTTPRest1'" />
    <log expr="'Data Fetched:' + _event.data.content" />
    <script>storeEvent("HTTPRest1", _event);</script>
    <script>App_HTTPRest1['data'] = eval('(' +
_event.data.content + ');</script>
    <assign location="headers" expr="App_HTTPRest1['data']" />
    <log expr="'Data Assigned: ' +
headers.toSource()"/>
  </transition>
</state>
```

[+] HTTP Rest Callflow Block Code Sample

```
<form id="HTTPRest1">
  <block>
    <assign name="AppState.var0" expr="''"/>
    <assign name="AppState.var1" expr="false"/>
    <data name="HTTPRest1Response" srcexpr="AppState.var3" enctype="application/json"
method="get"
      gvp:usernameexpr="'null'" gvp:passwordexpr="'null'"
fetchaudio="http://10.31.12.109:4040/Final_Test/Resources/Prompts/A.wav"
gvp:fetchaudiodelay="1s" gvp:fetchaudiominimum="10s" fetchhint="safe" fetchtimeout="120s"
maxage="50" maxstale="40" gvp:contentexpr="AppState.var4"/>
  </block>
</form>
```

```
<if cond="typeof HTTPRest1Response != 'undefined'">
<assign name="AppState.var0" expr="HTTPRest1Response"/>
    <assign name="AppState.var1" expr="true"/>
    <assign name="AppState.var2" expr="200"/>
    <goto next="#Log1" />
<else/>
    <assign name="AppState.var2" expr="204"/>
</if>
</block>
<catch event="error">
    <assign name="AppState.var2" expr="extractVxmlHttpErrorCode(_event)"/>
    <goto next="#Copy_1_Log1" />
</catch>
</form>
```

OPM Common Block

The OPM block enables VXML and SCXML applications to use Operational Parameters (OPM) which allow a business user to externally control the behavior of these applications. Operational Parameters are defined and managed in the [Operational Parameter Management \(OPM\)](#) feature of [Genesys Administrator Extension \(GAX\)](#). The OPM block is available for both Callflows (VXML) and Workflows (SCXML).

- At application design time in Composer, the OPM block allows browsing through a JSON structure based on metadata retrieved from the GAX server in order to form a JSON expression.
- At runtime code generated by the OPM block evaluates the specified expression and assign results to the App_OPM (voice application) or system.OPM (routing application) application variable accessible via the Entry block.

Important

OPM blocks access List Objects from the default Tenant (that is, Tenant associated with the ORS session) only. To access List Objects across Tenants, use the `ListGetDataCfg` method in the [URS Function Block](#). Using the `setTenant()` method is not recommended as this would impact URS and the newly created interactions in the session.

GAX Server

GAX refers to a [Genesys Administrator Extension \(GAX\)](#) plug-in application used by Genesys web application [Genesys Pulse](#) (formerly EZPulse). Genesys Pulse enables at-a-glance views of contact center real-time statistics in the GAX user interface. A button on the Composer main toolbar, Launch GAX Server Command, lets you launch the Genesys Administrator Extension used by the GAX Server. Composer uses the server host, port, username, and password entered on the [GAX Server Preferences](#) page to fetch audio resource management parameters or an audio resource IDs list. Before using this block set GAX Server Preferences.

Notes:

- The OPM block in Composer 8.1.2 supports GAX 8.1.2.
- GVP 8.1.6 supports OPM parameters only with lowercase key names - Composer includes a warning to that effect. Please consult your GVP version's documentation for any changes to this behavior.
- OPM Complex parameters like Schedule and Custom List types are not supported by GVP 8.1.6 and also not supported in Composer 8.1.3+.

Prerequisites

OPM Parameters in GAX must be associated with an IVR Profile (for callflows) or a routing strategy (for workflows). For more information on OPM parameter group associations, see:

- The [GVP 8.5 User's Guide](#), Provisioning IVR Profiles, IVR Profile Configuration Options, `gvp.context-services-authentication`, option transaction object ID.
- GAX User Guide on how to deploy or associate OPM parameters with an IVR or a routing application: [Parameter Group Templates](#).

The OPM block has the following properties:

Name Property

Find this property's details under [Common Properties for Workflow Blocks](#) or [Common Properties for Callflow Blocks](#)

Block Notes Property

Find this property's details under [Common Properties for Workflow Blocks](#) or [Common Properties for CallflowBlocks](#).

Exceptions Property

Find this property's details under [Common Properties for Workflow Blocks](#) or [Common Properties for Callflow Blocks](#)

Condition Property

Find this property's details under [Common Properties for Callflow Blocks](#) or [Common Properties for Workflow Blocks](#).

Logging Details Property

Find this property's details under [Common Properties for Callflow Blocks](#) or [Common Properties for Workflow Blocks](#).

Log Level Property



Find this property's details under [Common Properties for Callflow Blocks](#) or [Common Properties for Workflow Blocks](#).

Enable Status Property

Find this property's details under [Common Properties for Callflow Blocks](#) or [Common Properties for Workflow Blocks](#).

Assign OPM Data Property

Use this property to assign OPM parameters from GAX to variables.

1. Click opposite **Assign OPM Data** under **Value**. This brings up the  button.
2. Click the  button to bring up the Assign OPM Data dialog box.
3. Click **Add**.
4. Select the variable or click the **Variables** button to add a new variable.
5. Enter a value for the variable or click the  button where you can create an expression with [ExpressionBuilder](#).

Reread OPM Data Property

Select true or false to indicate whether to read OPM data during a **mid-call**. Note: In case of GVP, this property would be hidden as GVP does not support mid-call fetching.

ORS Extensions Property

Starting with 8.1.4, Composer blocks used to build routing applications (with the exception of the Disconnect and EndParallel blocks) add a new [ORS Extensions](#) property.

TLib Block

As of 8.1.410.14, the TLib block is temporarily disabled. Genesys recommends using the [SCXML State block](#) instead.

URS Function Block

Starting with 8.1.440.18, Composer supplies a URS Function block, applicable to workflow diagrams only. You can use this block to call [Universal Routing Server](#) functions via `<session:fetch>` by the `urs` method. The URS Function block has the following properties:

Name Property

Find this property's details under [Common Properties for Workflow Blocks](#). This is not the name of the function to call.

Block Notes Property

Find this property's details under [Common Properties for Workflow Blocks](#).

Exceptions Property

Find this property's details under [Common Properties for Workflow Blocks](#). There are no default exceptions for this block.

Condition Property

Find this property's details under [Common Properties for Workflow Blocks](#).

Logging Details Property

Find this property's details under [Common Properties for Workflow Blocks](#).

Log Level Property

Find this property's details under [Common Properties for Workflow Blocks](#).

ORS Extensions Property

Starting with 8.1.4, Composer blocks used to build routing applications (with the exception of the Disconnect and EndParallel blocks) add a new **ORS Extensions** property.

Result Property

Select the variable to hold the data returned by URS.

Function Name Property

Select the name of the URS function to call or select the variable that contains it. Function names can be specified as Variables, Literal and Enum (such as FindConfigObject, GetObjectProperty, TargetState) values. These three functions are listed by as samples, but you can call any URS function listed Table 130, Summary of All Functions, in the *Universal Routing 8.1 Reference Manual*. Function parameters are included in the function descriptions found in Chapter 3, Interaction Routing Designer Functions. Internally, the mapping is:

```
<session:fetch srcexpr="'urs/call/@' + system.InteractionID +  
'/func?name=URS_Function_Name ¶ms=[param1,param2] method="'urs'">
```

See the *Orchestration Server 8.1.3+ Developer's Guide*, Core Extensions, **Session Interface** section.

Interaction ID Property

Find this property's details under **Common Properties for Workflow Blocks**.

Parameters Property

Use to define the list of parameters to use with the specified function. Function parameters are included in the function descriptions found in the *Universal Routing 8.1 Reference Manual*, Chapter 3, Interaction Routing Designer Functions.

[+] FindConfigObject Configuration

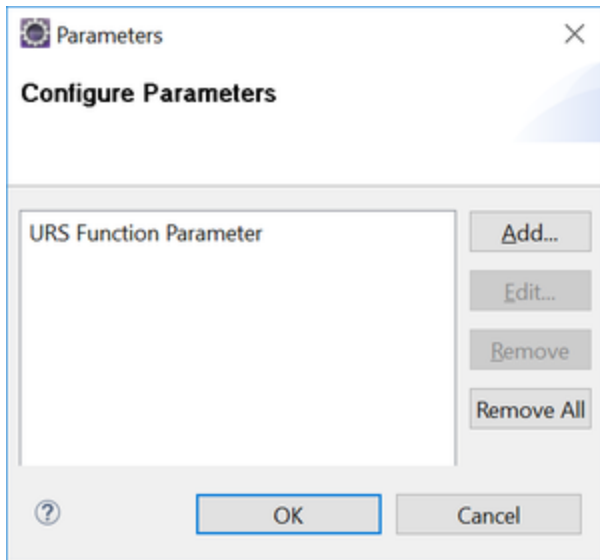

1. Click the ... button under **Value** to open the **Configure Parameters** dialog box.
2. Click **Add** to open the **Specify URS Function Parameter value** dialog box.
3. Specify the first function parameter. You can specify a variable or a literal. **Value is an integer** is applicable to both a literal and a variable.

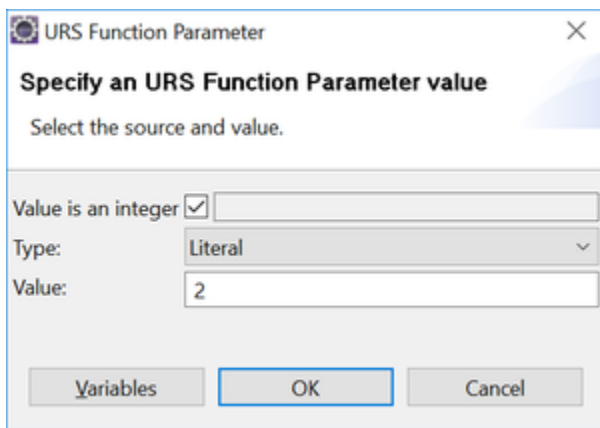

This example uses the FindConfigObject function to return the properties of a CfgDN object. (Parameters for GetObjectProperty and Target State are described further ahead.) The 2 above refers to the object TYPE, defined as a function parameter in the [Universal Routing 8.1 Reference Manual](#). In this example, the TYPE parameter happens to be a value formatted as a number. Refer to [List of Configuration Layer Enumerations](#) for possible Cfg object types. Also refer to [FindConfigObject](#) to learn about different search parameters required for the FindConfigObject method.

4. Click **OK**.
5. Click **Add** again in the **Configure Parameters** dialog box to enter another function parameter, if another one is specified in the [Universal Routing 8.1 Reference Manual](#). The dialog box shows <empty> when no value is set for a function parameter.
6. Click **OK**.

7. Continue adding any additional parameters used by the function. After defining all parameters, the **Configure Parameters** dialog box shows the parameters.

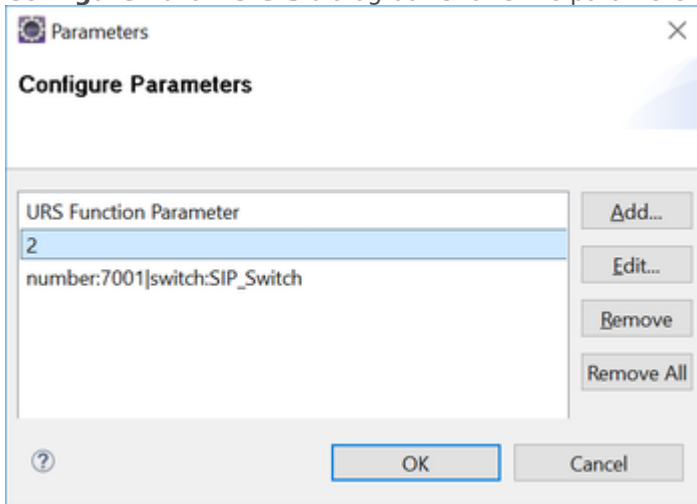

8. Click **OK** to close the dialog box.

The URS Function block Properties view shows the function parameters.

Properties		
URFunctionBlock		
Model	Property	Value
Appearance	Alias	
	Name	FindConfigObjectTest
	Annotation	
	Block Notes	
	Exceptions	
	Exceptions	
	Logging	
	Condition	
	Logging Details	
	Log Level	Project Default: Error
	Output	
	Result	
	Settings	
	Function Name	FindConfigObject
Interaction ID	Variable(system.InteractionID)	
Parameters	2, number:7001 switch:SIP_Switch	
Timeout	5	
Status		
Enable Status	Enabled	

[+] GetObjectProperty Configuration

The `GetObjectProperty` function requires all five parameters to be provided to retrieve the Annex or Options tab value of the Configuration Layer object. Refer to the [Universal Routing 8.1 Reference Manual](#) for further information. Parameters could be specified in the format as (Type, Subtype, Name, Section, Item) - (2, 0, 7039, TServer, contact).

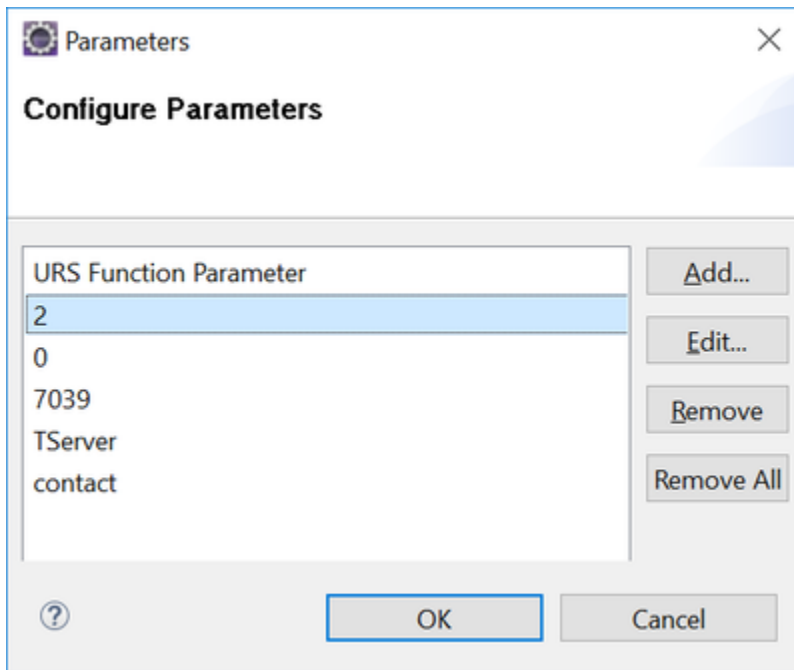

- 2 - Refers to the TYPE of the Configuration Layer object, Here for the CfgDN TYPE, the value formatted as a number is 2. Refer to [CfgObjectType](#) for possible Configuration Layer object types,
- 0 - Refers to the Subtype of the Configuration Layer object. Here there is no Subtype required so '0' is specified. Refer to [List of Configuration Layer Enumerations](#) for possible Configuration Layer Subtype values.
- 7039 - Refers to the Name of the Configuration Layer object. In the case of CfgDN, an alias is provided;
- TServer - Refers to the section in the Annex or Options tab of the Configuration Layer object.
- contact - Refers to the item for which the value is to be fetched.

[+] TargetState Configuration

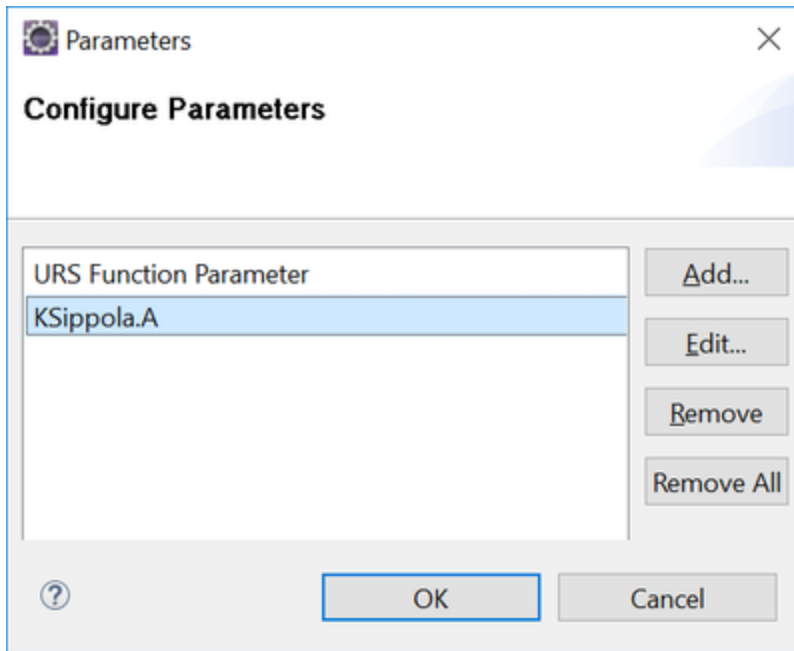

Type of Parameter	Parameter to be specified in URS Function block
Agent	TargetAgent.A or TargetAgent@StatServer.A
Place	TargetPlace.AP or TargetAgent@StatServer.AP

Timeout Property

Enter or select a variable that contains the maximum time to wait for an answer. The default timeout value configured for URS function block is 5 seconds.

Enable Status Property

Find this property's details under [Common Properties for Workflow Blocks](#).

Web Request Common Block

The Web Request block is used for both routing and voice applications. Use to invoke any supported HTTP web request or REST-style web Service.

- It supports PUT, DELETE, GET and POST methods.
- It is based on common Web Services standards such as XML, SOAP and WSDL instead of proprietary standards that are currently being replaced.

REpresentational State Transfer (REST) is an XML-based protocol for invoking Web Services over HTTP. REST is a lighter version of SOAP, which has evolved into a more complex protocol. REST-style web services offer a less coupled paradigm whereby simpler requests and responses are used. As an example, a simple HTTP request follows the REST methodology. The Web Request block allows the user to query "RESTful" Web services.

Important

Starting with version 8.1.450.33, Composer supports fetching HTTPS (HTTP over SSL) URLs in the Web Request and Web Service blocks.

The supported return formats for the Web Request block are:

- plain text. For workflows, the result will be returned in a JSON string with the key name result, e.g., {"result": this is a plain text result"}.
- plain XML.
- JSON string. See an issue pertaining to JSON objects in [Troubleshooting](#).

Important

When converting from XML to JSON, any leading zeroes in an attribute's value are truncated. If there are leading zeroes in a number, the number is considered as an Octal value and must be enclosed in quotes to be interpreted as a string.

In version 8.1.450.20, the SSL certificate validation code is disabled as Composer does not utilize this code for HTTP requests. If required, this code can be enabled on a demand basis by setting the `web.legacyCertificateCode` option to true in the **composer.properties** file. In previous versions, this code was always enabled.

Beginning with version 8.1.560.15, a new validation mode for SSL server certificates is introduced. If enabled, Composer does not add the server certificate to the trust store and instead only performs an expiry date validity check and signature check for the certificate. Users can manually add the required server certificates to the trust store. This new mode is applicable only for Composer Java

projects. To enable this mode, the `web.https.productionMode` property must be set to `true` in the **composer.properties** file. This property is set to `false` by default.

The Web Request block has the following properties:

Important

Some of the property names in this block are repeated under different categories. Such property names have been prefixed with the category name for readers to be able to easily differentiate the similar names on this page.

Name Property

Find this property's details under [Common Properties for Workflow Blocks](#) or [Common Properties for Callflow Blocks](#)

Block Notes Property

Find this property's details under [Common Properties for Workflow Blocks](#) or [Common Properties for Callflow Blocks](#).

Exceptions Property

Find this property's details under [Common Properties for Workflow Blocks](#) or [Common Properties for Callflow Blocks](#) You can also define [custom events](#).

Important

Server side exceptions from the Web Request block is optional from version 8.1.450.33. A new flag, `web.throwServerException`, is introduced. On adding the flag to the **composer.properties** file in the respective project and setting it to `true`, the Web Request block throws an `error.com.genesyslab.composer.servererror` error for failures. If the new flag is set to `false`, the the Web Request block updates the `errorMsg` entity in the JSON response.

Note: For JAVA projects, the `composer.properties` file is found in the **WEB-INF** folder of the respective

project. For .NET projects the **composer.properties** file is found in the **BIN** folder of the respective project. The **composer.properties** is not created by default by Composer, and users must create one, if required.

HTTPS SSL Authentication\Authentication Type

Use this property to select the type of authentication you want to implement for establishing an HTTPS SSL connection, Mutual Authentication, Server Authentication, or Anonymous.

- Anonymous (selected by default, introduced in 8.1.530.17) - server certificate validation is not performed by the client.
- Server Authentication (introduced in 8.1.450.33) - the client authenticates the server using the server's Public Key Certificate (PKC).
- Mutual Authentication (introduced in 8.1.530.17) - both client and server authenticate each other's identities before actual communication occurs.

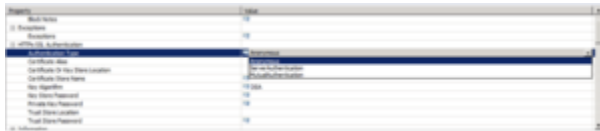

Important

If *Mutual Authentication* is selected here, the **certificateStoreName**, **Certificate Alias**, **Certificate or Key Store Location**, **Key Algorithm**, **Key Store Password**, **Private Key Password**, **Trust Store Location**, and **Trust Store Password** properties (all introduced in 8.1.530.17) are mandatory. The values specified in these properties are used during client certificate validation.

Important

For HTTPS URLs, only the **Server Authentication** and **Mutual Authentication** types are recommended.

HTTPS SSL Authentication\Trust Store Location

Use this property to specify the path to the certificate store location. The path must point to the keystore file (***.jks**) or **cacerts** (default trust store provided by JVM) that contains a list of certificate(s) that the Composer application trusts. The drop-down lists the Entry block variables by

default.

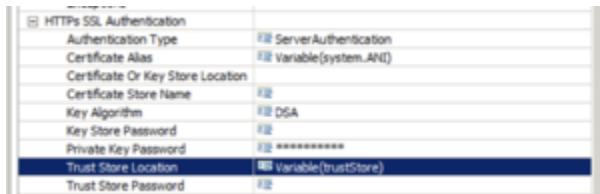

For Java projects, the drop-down is editable and the Java trust store can be customized and can override the default trust store location provided by the Java Virtual Machine.

- You can point to the default CA certificate residing at `$JAVA_HOME/lib/security/cacerts`, or
- Manually create a CA certificate file of their own (using the `keytool` utility).

Important

A forward slash denotes directory separation on the Linux OS. However, on Windows, a backward slash denotes directory separation. And since a backward slash is used for escaping characters in Java, you must include two backslashes when specifying the location for a Windows system. For example, `C:\\JAVA_HOME\\jre\\lib\\security\\cacerts`.

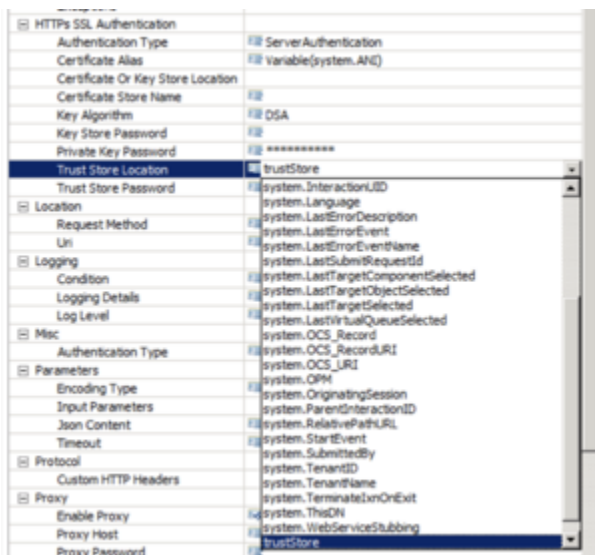

You can either select a variable that has the path or directly specify an absolute path.



For .NET projects, the drop-down is not editable. Windows has its own certificate store (StoreLocation.CurrentUser, StoreLocation.LocalMachine) and you cannot provide a new location or override the default location.

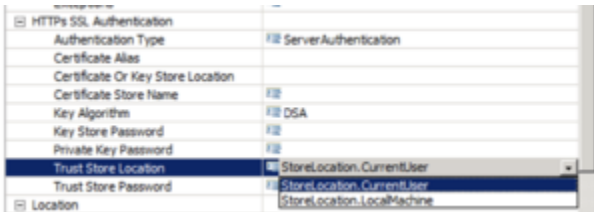

HTTPS SSL Authentication\Trust Store Password

Use this property to specify the password to access the specified trust store.

Important

This property is not applicable for .NET projects as access to the Windows store does not require a password.

HTTPS SSL Authentication\certificateStoreName

Use this property to specify the name of the key store that contains the client certificate entry. The supported key store types are jks and pkcs12.

Sample value for a Java project: keystore.jks.

HTTPS SSL Authentication\Certificate Alias

Use this property to provide an alias for the client certificate.

Sample value for a Java project: keyAlias.

HTTPS SSL Authentication\Certificate or Key Store Location

Use this property to specify the path to the key store location that contains the client certificate.

Sample value for a Java project: `C:\North\KeyStore_Certificates`.

Important

Windows has its own certificate store (`StoreLocation.CurrentUser` , `StoreLocation.LocalMachine`) and you cannot create or override this default store for .NET projects.

HTTPS SSL Authentication\Key Algorithm

Use this property to select the type of key algorithm (RSA or DSA) to be used during client certificate validation.

HTTPS SSL Authentication\Key Store Password

Use this property to provide the password to access the specified key store.

HTTPS SSL Authentication\Private Key Password

Use this property to specify the password to access the client certificate's private key.

Request Method Property

This property Indicates the method for invoking the web request:

- **get**--Invoked using HTTP Get.
- **post**--Invoked using HTTP Post.
- **put**--Invoked using HTTP Put.
- **delete**--Invoked using HTTP Delete.

To select a value for the Request Method property:

1. Select the **Request Method** row in the block's property table.
2. In the **Value** field, select get, post, put, or delete from the drop-down list.

Uri Property

The Uri property specifies the http:// page to invoke. To set a URL destination for the Uri property:

1. Select the **Uri** row in the block's property table.
2. In the **Value** field, click the down arrow and select the variable that contains URL.

Condition Property

Find this property's details under [Common Properties for Callflow Blocks](#) or [Common Properties for Workflow Blocks](#).

Logging Details Property

Find this property's details under [Common Properties for Callflow Blocks](#) or [Common Properties for Workflow Blocks](#).

Log Level Property

Find this property's details under [Common Properties for Callflow Blocks](#) or [Common Properties for Workflow Blocks](#).

Misc\Authentication Type Property

The Authentication Type property specifies whether to use an anonymous or basic authentication for the web request. To assign a value to the Authentication Type property:

1. Select the Authentication Type row in the block's property table.
2. In the Value field, select anonymous (default) or basic from the drop-down list. With the anonymous type of access, no user name/password is passed to Web service for client authentication in order to get data. If you select the basic type of access, you must supply the Login Name and Password properties.

ORS Extensions Property

Starting with 8.1.4, Composer blocks used to build routing applications (with the exception of the Disconnect and EndParallel blocks) add a new **ORS Extensions** property.

Encoding Type Property

The Encoding Type property (used for callflows only) indicates the media encoding type of the submitted document. GVP 8.1 supports two encoding types:

- application/x-www-form-urlencoded
- multipart/form-data

To select a value for the Encoding Type property:

1. Select the **Encoding Type** row in the block's property table.
2. In the **Value** field, select one of the following:
 - **application/x-www-form-urlencoded (default)**
 - **application/json**

Input Parameters Property

Use the Input Parameters property to specify a list of required Name/Value pairs to pass as parameters to the http:// page. To specify input parameters:

1. Click the Parameters row in the block's property table.
2. Click the  button to open the Parameter Settings dialog box.

Add Button Use the Add button to enter parameter details.

1. Click **Add** to add an entry to Web Request Parameters.
2. In the **Parameter Name** field, accept the default name or change it.
3. From the **Parameter Type** drop-down list, select **In**, **Out**, or **InOut**:

In	Input parameters are variables submitted to the web request.
Out	Output parameters are variables that the web request returns and will be reassigned back to the current callflow/workflow.
InOut	InOut parameters are parameters that act as both input and output.

1. In the Expression drop-down list, select from among the variables shown, type your own expression, or click the  button to use **Expression Builder**.
2. In the Definition field, type a description for this parameter.
3. Click Add again to enter another parameter, or click OK to finish.

Delete Button To delete a parameter:

1. Select an entry from the list.
2. Click **Delete**.

JSON Content Property

If the HTTP request to be invoked expects JSON content, this property can be used to specify that input. It expects a variable whose content will be sent to the API specified in the HTTP URI property of the block. Set the Encoding Type property of the block to `application/json`. In this case, the Input Parameters property will not be used.

The variable selected in this property should contain a JavaScript object. The object can be built from a JSON string, or using the ECMAScript block.

For example, if you would like to pass a JSON content to the HTTP URI, using a variable named "content", the variable can be initialized in the following ways:

- If you have a JSON string, you can use the Assign block to assign the following value to "content":

```
JSON.parse('{ "abc": "def", "xyz": 3 }')
```

- Alternately, you can build a JavaScript object using an ECMAScript block with code like the following:

```
var content = new Object(); content['abc'] = 'def'; content['xyz'] = 3;
```

In both cases, set the JSON Content property of the Web Request block to the variable named "content".

Timeout Property

Select the variable containing the number of seconds that the application will wait when fetching the result of the Web Service or the Web Request or keep the default of 90 (added starting with 8.1.440.18). If the requested resource does not respond in that time, then a timeout event will occur.

Custom HTTP Headers Property

Use this property to add Custom headers to be sent along with the HTTP request during the runtime

execution of the Server Side block.

1. Click the row in the block's property table.
2. Click the  button to open the Custom HTTP Headers dialog box.
3. Click **Add** to open Configuration Custom HTTP Headers dialog box.
4. Select a Header type.
5. Select **Literal** or **Variable**.
6. Type the literal value or select the variable that contains the value.

Proxy Property

You can specify a proxy server to act as an intermediary server when making requests for Web Services from other servers. The proxy server evaluates the request as a way to simplify and control its complexity. Today, most proxies are web proxies, facilitating access to content on the World Wide Web and providing anonymity. To configure:

- Set **Enable Proxy** to true or false.
- Enter the IP address of the web proxy **Host**.
- Enter the **Password** for the web proxy.
- Enter the web proxy **Port**.
- Enter the web proxy **User Name**.

Login Name Property

Used when Misc\Authentication Type = basic. The Login Name property specifies the login name for the invoked web page. To provide a login name for the web request:

1. Select the **Login Name** row in the block's property table.
2. In the **Value** field, type a valid login name.

Password Property

Used when Misc\Authentication Type = basic. The Password property specifies the password for the invoked web page. To provide a password for the web request:

1. Select the **Password** row in the block's property table.
2. In the **Value** field, type a valid password that corresponds to the login name above or, starting with 8.1.440.18, you can select the password from a variable.

Enable Status Property

Find this property's details under [Common Properties for Callflow Blocks](#) or [Common Properties for Workflow Blocks](#).

Verify JSON Response

Composer 8.1.400.35 adds this property. When set to `false`, the Web Request block will not parse the JSON response and will return it as-is. The default is `true`. Add this property to the Properties view by clicking the **Show Advanced Properties** button.



Result Property

The Result property is the variable used to get back a result from the web request. To select a variable:

1. Select the **Result** row in the block's property table.
2. In the **Value** field, select one of the available variables from the drop-down list. Does not need to match the variable name that is coming back as a result of the web request.

Web Service Common Block

The Web Service block allows you to develop an application that supports secure mutual authentication and communication with a Web Service, through the use of both a digital client certificate and server certificate contained in a keystore file.

This functionality is supported for both callflows and workflows. In both cases, Composer generates all the necessary code based on the visual callflow or workflow, so you do not have to write any server-side code to supplement the communication with the external Web Service.

In version 8.1.450.20, the SSL certificate validation code is disabled as Composer does not utilize this code for HTTP requests. If required, this code can be enabled on a demand basis by setting the `web.legacyCertificateCode` option to `true` in the **composer.properties** file. In previous versions, this code was always enabled.

Beginning with version 8.1.560.15, a new validation mode for SSL server certificates is introduced. If enabled, Composer does not add the server certificate to the trust store and instead only performs an expiry date validity check and signature check for the certificate. Users can manually add the required server certificates to the trust store. This new mode is applicable only for Composer Java projects. To enable this mode, the `web.https.productionMode` property must be set to `true` in the **composer.properties** file. This property is set to `false` by default.

Video Tutorial

Below is a video tutorial on using the Web Service block.

Tip

While the interface for Composer in this video is from release 8.0.1, the steps are basically the same for subsequent releases.

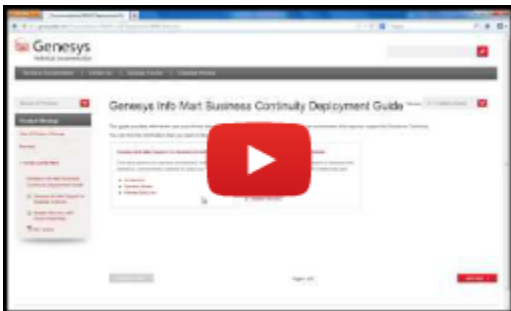

SOAP-Compliant Web Services

This block can be used to invoke SOAP 1.1 compliant Web Services. It accepts and parses WSDL content for the WebService and collects input parameters based on this WSDL content.

- Uses common Web Services standards such as XML, [SOAP](#) and WSDL.
- You can pass parameters (as in subdialogs) and store the return values in variables.
- GET and POST methods are supported.
- Supports SOAP 1.1 and therefore requires a WSDL file to describe [endpoints](#) and services. The Web Service block will not work without this WSDL file.
- WSDL-based Web Services are supported with certain limitations. The WSDL is parsed and you are provided the option to select the service name, bindings type, operations, service end point, and mode (GET / POST). The Input and Output parameter list is pulled by default from the WSDL.

Data returned by the Web Service is converted to JSON format and made available in the application. (See an issue pertaining to JSON objects in [Troubleshooting](#).)

Important

SOAP 1.2 is not supported.

Additional Information

For additional information, see:

- [Web Service Block and SignedSOAPRequests](#) and [Web Service SOAP Message Examples](#).
- [WSDL_SOAP_XSD_WSSE_Support](#)

Web Service Block Security

For Java and .NET Composer projects, the Web Service Block supports secured SOAP communication using XML Digital Signature with a Client Certificate for Java Composer Projects. XML Digital Signature authentication is in compliance with the Second Edition of the [XML Signature Syntax and Processing Specification](#) and the [OASIS Web Services Security SOAP Messages Security Specification](#). The [Authentication Type property](#) below allows you to select various types of authentication.

Testing the Web Service Block

When working with either a callflow or workflow, the Web Service block provides menu option to test the configured SOAP Web Service using the Web Services Explorer. Right-click the Web Services block and select **Test with Web Services Explorer**.

The Web Service block has the following properties:

Important

Some of the property names in this block are repeated under different categories. Such property names have been prefixed with the category name for readers to be able to easily differentiate the similar names on this page.

Name Property

Find this property's details under [Common Properties for Callflow Blocks](#) or [Common Properties for Workflow Blocks](#).

Block Notes Property

Find this property's details under [Common Properties for Callflow Blocks](#) or [Common Properties for Workflow Blocks](#).

Exceptions Property

Find this property's details under [Common Properties for Callflow Blocks](#) or [Common Properties for Workflow Blocks](#). You can also define [custom events](#). The Web Service block Exceptions dialog box has the following pre-set exceptions:

- Callflows: `error.badfetch` and `error.com.genesyslab.composer.webservice.badFetch`
- Workflows: `error.session.fetch` and `error.com.genesyslab.composer.webservice.badFetch`

Important

Server side exceptions from the Web Service block is optional from version 8.1.450.33. A new flag, `web.throwServerError`, is introduced. On adding the flag to the **composer.properties** file in the respective project and setting it to `true`, the Web Service block throws an `com.genesyslab.composer.servererror` error for failures. If the new flag is set to `false`, the the Web Service block updates the `errorMsg` entity in the JSON response. If the particular configuration option is not found in the **composer.properties** file, the Web Request or Web Service block updates the `errorMsg` entity in the JSON response (as when the flag is set to `false`).

Note: For JAVA projects, the **composer.properties** file is found in the **WEB-INF** folder of the respective project. For .NET projects the **composer.properties** file is found in the **BIN** folder of the respective project. The **composer.properties** is not created by default by Composer, and users must create one, if required.

HTTPS SSL Authentication\Authentication Type

Use this property to select the type of authentication you want to implement for establishing an HTTPS SSL connection, Mutual Authentication, Server Authentication, or Anonymous.

- Anonymous (selected by default, introduced in 8.1.530.17) - server certificate validation is not performed by the client.
- Server Authentication (introduced in 8.1.450.33) - the client authenticates the server using the server's Public Key Certificate (PKC).
- Mutual Authentication (introduced in 8.1.530.17) - both client and server authenticate each other's identities before actual communication occurs.

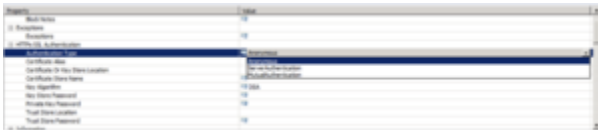

Important

If *Mutual Authentication* is selected here, the **certificateStoreName**, **Certificate Alias**, **Certificate or Key Store Location**, **Key Algorithm**, **Key Store Password**, **Private Key Password**, **Trust Store Location**, and **Trust Store Password** properties (all introduced in 8.1.530.17) are mandatory. The values specified in these properties are used during client certificate validation.

Important

Basic HTTP Authentication properties in the Web Service block are validated only during runtime in the server-side pages (ASPX/JSP). For design time, WSDL parsing authentication is not supported. You can copy the WSDL file to the **Include** folder within the required **Composer Project** folder and specify `include/<filename.wsdl>` in the **Service URL** property to parse the WSDL file and configure the block.

Important

For HTTPS URLs, only the **Server Authentication** and **Mutual Authentication** types are recommended.

HTTPS SSL Authentication\Trust Store Location

Use this property to specify the path to the certificate store location. The path must point to the keystore file (*.jks) or **cacerts** (default trust store provided by JVM) that contains a list of certificate(s) that the Composer application trusts. The drop-down lists the Entry block variables by default.



For Java projects, the drop-down is editable and the Java trust store can be customized and can override the default trust store location provided by the Java Virtual Machine.

- You can point to the default CA certificate residing at `$JAVA_HOME/lib/security/cacerts`, or
- Manually create a CA certificate file of their own (using the [keytool](#) utility).

Important

A forward slash denotes directory separation on the Linux OS. However, on Windows, a backward slash denotes directory separation. And since a backward slash is used for escaping characters in Java, you must include two backslashes when specifying the location for a Windows system. For example, `C:\\JAVA_HOME\\jre\\lib\\security\\cacerts`.

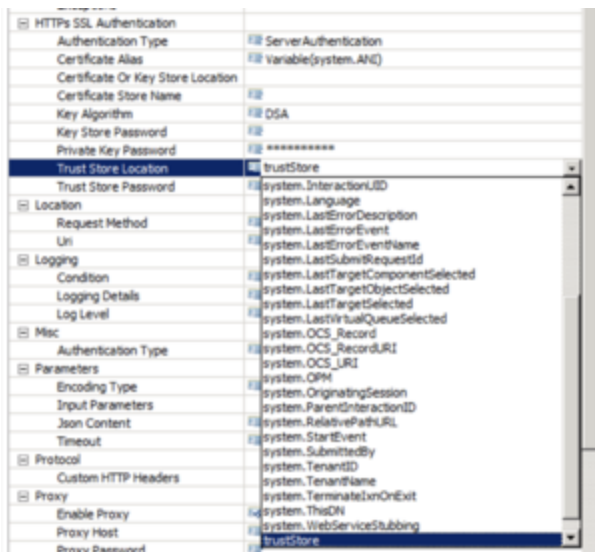

You can either select a variable that has the path or directly specify an absolute path.

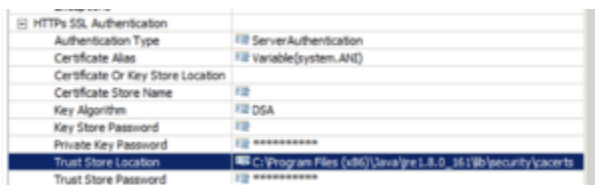

For .NET projects, the drop-down is not editable. Windows has its own certificate store (StoreLocation.CurrentUser, StoreLocation.LocalMachine) and you cannot provide a new location or override the default location.

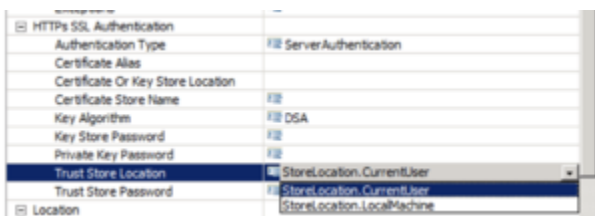

HTTPS SSL Authentication\Trust Store Password

Use this property to specify the password to access the specified trust store.

Important

This property is not applicable for .NET projects as access to the Windows store does not require a password.

HTTPS SSL Authentication\certificateStoreName

Use this property to specify the name of the key store that contains the client certificate entry. The supported key store types are jks and pkcs12.

Sample value for a Java project: keystore.jks.

HTTPS SSL Authentication\Certificate Alias

Use this property to provide an alias for the client certificate.

Sample value for a Java project: keyAlias.

HTTPS SSL Authentication\Certificate or Key Store Location

Use this property to specify the path to the key store location that contains the client certificate.

Sample value for a Java project: C:\North\KeyStore_Certificates.

Important

Windows has its own certificate store (`StoreLocation.CurrentUser` , `StoreLocation.LocalMachine`) and you cannot create or override this default store for .NET projects.

HTTPS SSL Authentication\Key Algorithm

Use this property to select the type of key algorithm (RSA or DSA) to be used during client certificate validation.

HTTPS SSL Authentication\Key Store Password

Use this property to provide the password to access the specified key store.

HTTPS SSL Authentication\Private Key Password

Use this property to specify the password to access the client certificate's private key.

Service URL Property

The Service URL property specifies the WSDL URL of the Web Service to invoke. To set the Service URL:

1. Select the **Service URL** row in the block's property table.
2. In the **Value** field, type a valid URL.

When you provide the WSDL URL in the Service URL property, Composer will try to access the URL and parse it to populate the drop-down lists for the remaining properties:

- **Available Services**
- **Bindings**
- **Operations**
- **Service End Point**
- **Use Protocol**

Note: When *upgrading older diagrams to 8.1.1 and higher, it is necessary to clear out the service URL* and specify it again. This is needed in newer versions to re-parse the WSDL obtained from the specified URL and not use the cached information stored in the diagram.

Available Services Property

When Composer accesses the Service URL, the available Web Services will populate the drop-down list of the Available Services property. To select an available service:

1. Click the **Available Services** row in the block's property table.
2. In the **Value** field, select an available Web Service from the drop-down list.

Bindings Property

When Composer accesses the Service URL, the available bindings will populate the drop-down list of the Bindings property. To select a binding:

1. Click the **Bindings** row in the block's property table.
2. In the **Value** field, select an available bindings setting from the drop-down list.

Operations Property

When Composer accesses the Service URL, the available operations will populate the drop-down list of the Operations property. To select an operation:

1. Click the **Operations** row in the block's property table.
2. In the **Value** field, select the desired operation from the drop-down list.

Service End Point Property

When Composer accesses the Service URL, the service end point options will populate the drop-down list of the Service End Point property. To select a service end point:

1. Click the **Service End Point row in the block's property table.**
2. In the **Value** field, select the service end point from the drop-down list.

Service End Point Variable Property

Use this property to parameterize the Service End Point in the Web Service block. This property will overwrite the above Service End Point property literal value. This enables you to move the workflows across different environments. Moving applications between a test environment and a production environment is same for both .NET and Java Projects. Only deployment procedures might change depending on the Web Server involved. The Web Service Block -> Service End Point Variable property can be used to externalize the Web Service URLs for different environments.

Use Protocol Property

When Composer accesses the Service URL, the protocol options (SOAP and HTTP) will populate the drop-down list of the Use Protocol property. To select a protocol:

1. Click the **Use Protocol** row in the block's property table.
2. In the **Value** field, select SOAP or HTTP from the drop-down list.

Condition Property

Find this property's details under [Common Properties for Callflow Blocks](#) or [Common Properties for Workflow Blocks](#).

Logging Details Property

Find this property's details under [Common Properties for Callflow Blocks](#) or [Common Properties for Workflow Blocks](#).

Log Level Property

Find this property's details under [Common Properties for Callflow Blocks](#) or [Common Properties for Workflow Blocks](#).

Enable Status Property

Find this property's details under [Common Properties for Callflow Blocks](#) or [Common Properties for Workflow Blocks](#).

Input Parameters Property

Note: The Web Service block won't work with IRD if the Web Service parameters are named double since URS considers it a reserved keyword. The same Web Service block will work fine in the voice application. After you have chosen the available service and operations which you want to invoke, along with bindings, service end point, and protocol, use the Input Parameters property to specify a list of required Name/Value pairs to pass as parameters to the Web Service URL. To specify input parameters:

1. Click the **Parameters** row in the block's property table.
2. Click the  button to open the Parameter Settings dialog box.

Add Button

Use the **Add** button to enter parameter details.

1. Click **Add** to add an entry to Web Service Parameters.
2. In the **Parameter Name** field, accept the default name or change it.
3. From the **Parameter Type** drop-down list, select **In**, **Out**, or **InOut**:

In	Input parameters are variables submitted to the web service.
Out	Output parameters are variables that the web service returns and will be reassigned back to the current callflow/workflow.
InOut	InOut parameters are parameters that act as both

input and output.

4. In the **Expression** drop-down list, select from among the **variables** shown, type your own expression, or click the button to use **Skill Expression Builder**.
5. In the **Definition** field, type a description for this parameter.
6. Click **Add** again to enter another parameter, or click OK to finish.

Delete Button

To delete a parameter:

1. Select an entry from the list.
2. Click **Delete**.

Timeout Property

Select the variable containing the number of seconds that the application will wait when fetching the result of the Web Service or the Web Request or keep the default of 90 (added in 8.1.440.18). If the requested resource does not respond in that time, then a timeout event will occur.

Custom HTTP Headers Property

Use this property to add Custom headers to be sent along with the HTTP request during the runtime execution of the Server Side block.

1. Click the row in the block's property table.
2. Click the  button to open the Custom HTTP Headers dialog box.
3. Click **Add** to open Configure Custom HTTP Headers dialog box.

Note: The list of headers is a standard list defined by the HTTP protocol. You can optionally specify a list of headers. For each header, the name can be selected from the drop down list or keyed in. The value can be specified as literal values or as variable. There is no special format.

1. Select a **Header type**.
2. Select **Literal** or **Variable**.
3. Type the literal value or select the variable that contains the value.

Proxy Property

You can specify a proxy server to act as an intermediary server when making requests for Web

Services from other servers. The proxy server evaluates the request as a way to simplify and control its complexity. Today, most proxies are web proxies, facilitating access to content on the World Wide Web and providing anonymity. To configure:

- Set **Enable Proxy** to true or false.
- Enter the IP address of the web proxy **Host**.
- Enter the **Password** for the web proxy.
- Enter the web proxy **Port**.
- Enter the web proxy **User Name**.

Security\Authentication Type Property

To assign a value to the Authentication Type property:

1. Select the **Authentication Type** row in the block's property table.
2. In the **Value** field, select from the following:
 - **Anonymous**--With the anonymous type of access, no user name/password is passed to Web service for client authentication in order to get data.
 - **HTTP Basic Authentication**--HTTP Protocol level Basic Authentication using Authorization header. If you select the basic type of access, you must supply the Login Name and Password properties.
 - **SOAP Message Level Basic Authentication**--SOAP Message level Basic Authentication for legacy Web Services using <BasicAuth> header.-- Rarely used but for compatibility.
 - **SOAP XML Signature Authentication**--SOAP Message level XML Digital Signature Authentication using Client Certificate.
 - **SOAP Signature with HTTP Basic Authentication**--SOAP Message Level XML Digital Signature Authentication using Client Certificate + HTTP Basic Authentication (for the Web Server level).

Login Name Property

Used when Security\Authentication Type = HTTP Basic Authentication. The Login Name property specifies the login name for the invoked web page. To provide a login name for the web request:

1. Select the **Login Name** row in the block's property table.
2. In the **Value** field, type a valid login name or select the name from a variable.

Password Property

Used when Security\Authentication Type = HTTP Basic Authentication. The Password property specifies the password for the invoked web page. To provide a password for the web request:

1. Select the **Password** row in the block's property table.
2. In the **Value** field, type a valid password that corresponds to the login name above or select the password from a variable.

SOAP Digital Signature\Certificate Store Name Property

Use this property to specify the name of the Windows Certificate Store. See [WebService Block and Signed SOAP Requests](#). To select a variable:

1. Select the **Certificate Store Name** row in the block's property table.
2. In the **Value** field, select one of the available [variables](#) from the drop-down list.

SOAP Digital Signature\Certificate Alias Property

Use this property to specify the Client Certificate Name. See [Web Service Block and Signed SOAP Requests](#). To select a variable:

1. Select the **Certificate Alias** row in the block's property table.
2. In the **Value** field, select one of the available [variables](#) from the drop-down list.

SOAP Digital Signature\Certificate or Key Store Location Property

Use this property to specify the location of the Certificate Store or Key Store. See [Web Service Block and Signed SOAP Requests](#). To select a variable:

1. Select the **Certificate or Key Store Location** row in the block's property table.
2. In the **Value** field, select one of the available [variables](#) from the drop-down list.

SOAP Digital Signature\Key Algorithm Property

Select DSA (default) or RSA to specify the Key Algorithm to sign the SOAP Digital Signature. See [Web Service Block and Signed SOAP Requests](#). Use this property to specify the Key Store Password. See [Web Service Block and Signed SOAP Requests](#). To select a variable:

1. Select the **Key Algorithm** row in the block's property table.
2. In the **Value** field, select one of the available **variables** from the drop-down list.

SOAP Digital Signature\Key Store Password Property

To select a variable:

1. Select the **Key Store Password** row in the block's property table.
2. In the **Value** field, select one of the available **variables** from the drop-down list. Does not need to match the variable name that is coming back as a result of the web request.

SOAP Digital Signature\Private Key Property

Use this property to specify private key of the Client Certificate. See Web Service Block and Signed SOAP Requests. To select a variable:

1. Select the **Private Key** row in the block's property table.
2. In the **Value** field, select one of the available **variables** from the drop-down list.

SOAP Digital Signature\Private Key Password Property

Use this property to specify the private key password. See Web & Service Block and Signed SOAP Requests. To select a variable:

1. Select the **Private Key Password** row in the block's property table.
2. In the **Value** field, select one of the available **variables** from the drop-down list.

Custom Prefix Property

Use this property to set custom namespace to the generated SOAP message tags. If this property is set it will overwrite the default / WSDL namespace prefix.

Note: To access this property, ensure that the **Show Advanced Properties** option is selected on the toolbar.

Add Namespace Prefix Property

Use this property to add Namespace prefix to the generated SOAP message. By default Composer

Web Service client doesn't generate namespace prefixes.

1. None - Do not add any namespace prefix to the SOAP:Body elements.
2. Method Name Tag Only - Add namespace prefix only to the Method Name tag (Operational name tag).
3. Method Name Tag and Child Tags - Add namespace prefix to all the tags in the SOAP message.

Note: To access this property, ensure that the **Show Advanced Properties** option is selected on the toolbar.

Custom SOAP Envelope Property

Use this property to set Custom SOAP Envelope messages. If this property is set, the Composer Web Service run-time client will use this message to get a Web Service response.

1. Click the **Custom SOAP Envelope** property under the **SOAP Message Generation** category. The Custom SOAP Envelope dialog is displayed.
2. Add the custom SOAP Envelope message (the message can be generated using any Web Service client tool).

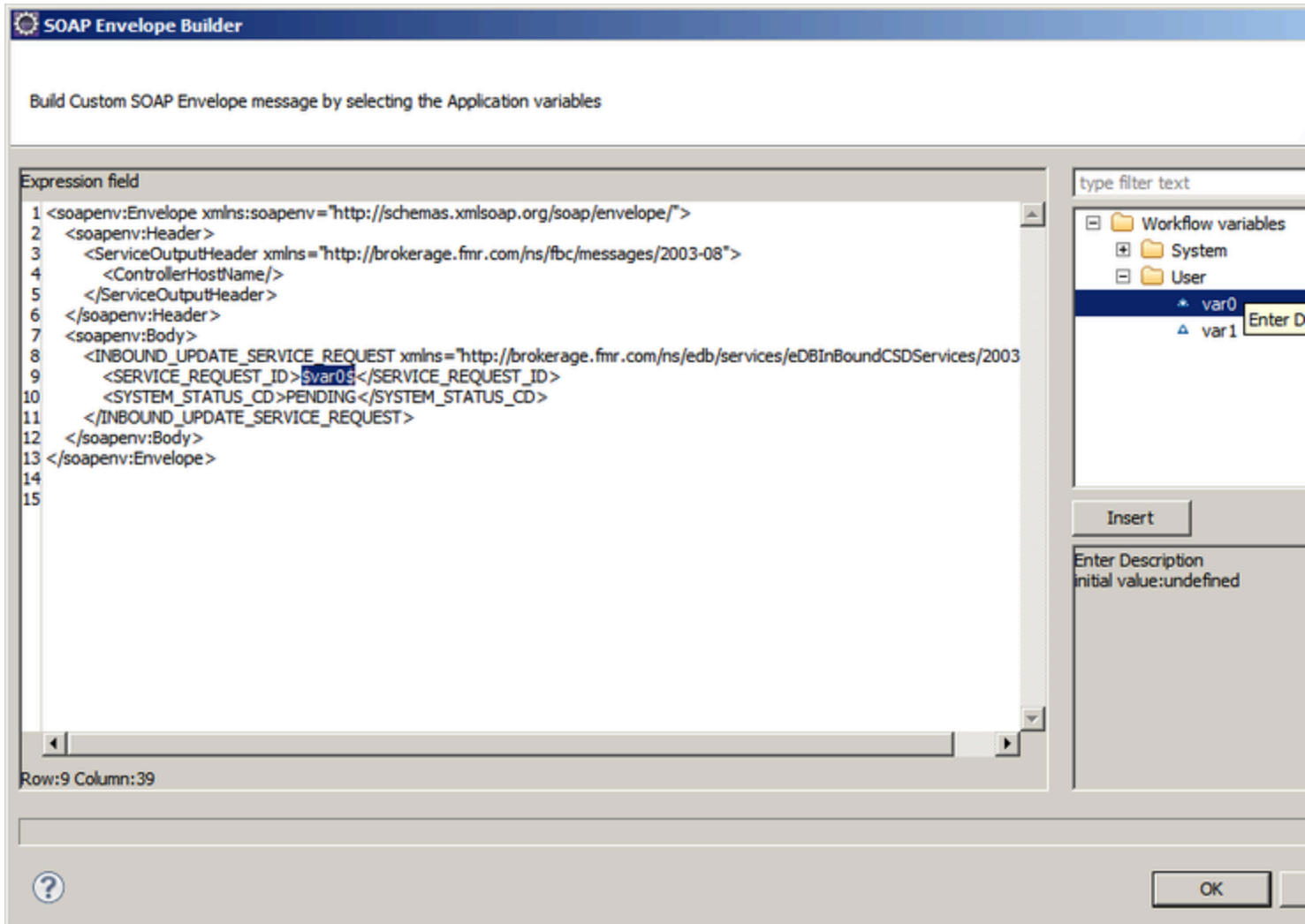

Custom SOAP Envelope Dialog

The custom message is sent to the Web Service URL at run-time. Diagram application variables can be used to form dynamic contents. Variables can be used in the custom message with a **\$<Variable_Name>\$** notation.

Note:

1. To access this property, ensure that the **Show Advanced Properties** option is selected on the toolbar.
2. This property is supported for both Java Composer Projects and .NET Composer Projects.
3. Callflow-Root document variables and Workflow-Project variables are not supported in this property.

Output Result Property

When the **Map Output Values to Variables** property below is set to true, the Output Result property

maps the Web Service response keys to AppState variables. If Map Output Values to Variables is set to false, the entire Web Service response will be assigned to a variable. The Output Result property is the variable used to get back the invoked Web Service result. To select a variable:

1. Select the **Output Result** row in the block's property table.
2. In the **Value** field, select one of the available variables from the drop-down list. Does not need to match the variable name that is coming back as a result of the web request.

Map Output Values to Variables Property

The Map Output Values to Variables property indicates whether or not to map the Web Service response keys to AppState variables. To select a value for the Map Output Values to Variables property:

1. Select the **Map Output Values to Variables** row in the block's property table.
2. In the **Value** field, select true or false from the drop-down list.

ORS Extensions Property

Starting with 8.1.4, Composer blocks used to build routing applications (with the exception of the Disconnect and EndParallel blocks) add a new **ORS Extensions** property.

Example Block Properties

Example properties for a Web Service block are shown below.

Property	Value
[-] Alias	
Name	getGoldRate
[-] Information	
Service URL	http://www.websvcex.net/CurrencyConvertor.asmx?WSDL
[-] Invoking Configurations	
Available Services	CurrencyConvertor
Bindings	CurrencyConvertorSoap
Operations	ConversionRate
Service End Point	http://www.websvcex.net/CurrencyConvertor.asmx
Use Protocol	SOAP
[-] Parameters	
Input Parameters	Stubbed Parameter(FromCurrency,input), Stubbed Parameter(ToCurrency,input)
[-] Security	
Authentication Type	anonymous
Login Name	
Password	
[-] Web Service Result	
Map Output Values To Variables	true
Output Result	Stubbed Parameter(WebServiceResponseMessage,output)

ExampleWebService.gif

Web Services Description Language (WSDL) Support

Composer supports WSDL definitions conforming to the version WSDL 1.1 schema.

Errors in WSDL Parsing

The following Composer symptom may indicate errors in WSDL parsing:

- If the WSDL definition contains any of the unsupported types and elements, Composer may not be able to parse the WSDL correctly to identify the input and output parameters of the Web Service.
- If the Composer WSDL parser is unable to properly parse the WSDL definition for the Web Service, the input and output parameters fields in the Web Service Parameters dialog box might be empty, with no pre-configured parameters as shown below.

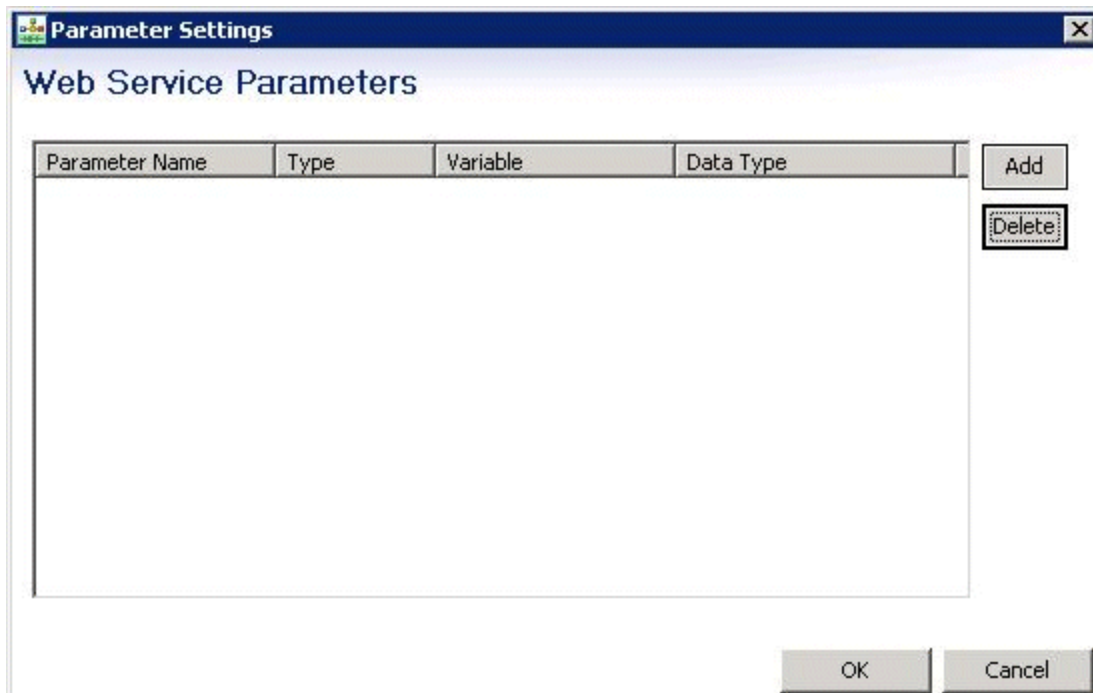

Workarounds

Currently, the following workarounds are available to change the schemas to work with Composer:

- Use qualified elementFormDefault (elementFormDefault="qualified") and define types with fully qualified namespace definitions.
- Define all wsdl types in one schema.
- Replace reference attributes with the actual types being referenced.
- Use the Add/Delete buttons to add or remove any parameters that may not have been automatically displayed. The SOAP request that will be generated at application runtime will take these changes into account.

Note

Composer Web Service block-generated SOAP messages do not have prefix in the SOAP elements. Web Services created using Metro / JAX-WS framework may return Null Pointer Exception or Unexpected Result due to the prefix limitation. Updating the JAX-WS API's / GlassFish server / Metro WS Framework to latest versions may help.

Microsoft Web Services Enhancements (WSE) Not Installed

See [.NET Troubleshooting](#) for steps on working with Composer .NET Projects when a machine does

not have WSE 3.0:

Web Service Stubbing

Composer's Web Services stubbing feature allows you to work with Web Services in off-line mode when you do not have access to the Web Service itself or if the Web Service is under development. This feature is intended to be used in a test environment. It is not intended for a production environment unless there is need to remove an active Web Service from a callflow for debugging purposes.

Using Web Services Stubbing

To use Web Services stubbing:

1. To enable stubbing, add the variable `COMPOSER_WSSTUBBING` to your Entry block and set its value to 1 indicating stubbing is turned on (0 = stubbing is turned off). In Composer 8.0.2 and later, this variable is present by default in the **Set Application Variables** dialog box, which opens from the Entry object.
2. Create the Web Service block.
3. Place the Web Service Description Language (WSDL) file in your Project. The assumption is that the WSDL file for the Web Service is available at all times.
4. For the **Service URL** property, use a local URL to the WSDL file. When the Web Service is ready to be used, change this local URL to the correct URL.)
5. To specify the expected output value for the Web Service result as well as any output parameters, use the **Output Result** property of the Web Service block. An example is shown below.

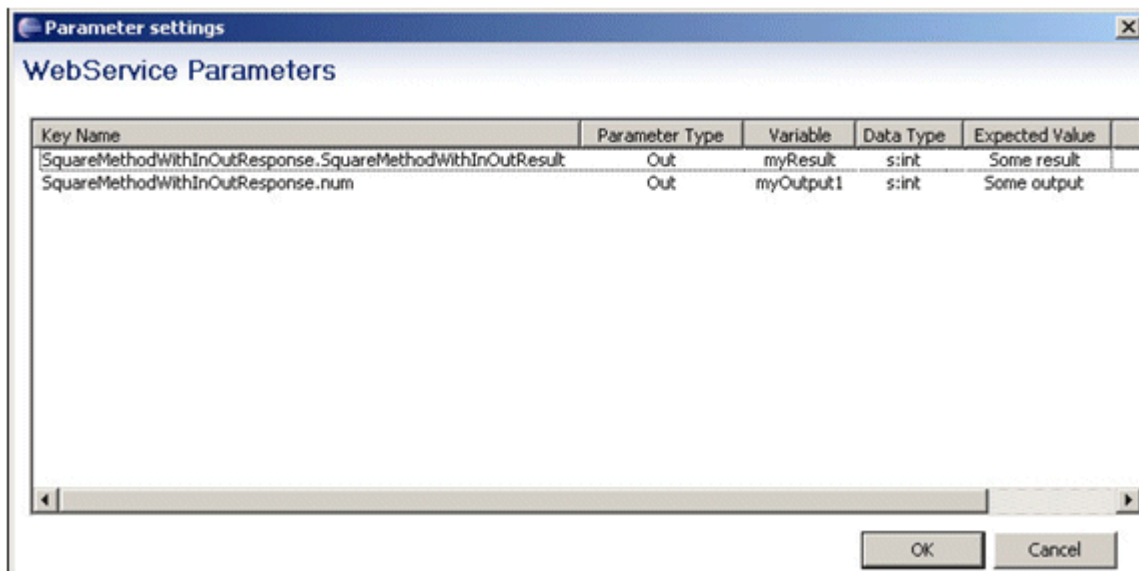

Using the above examples:

- If stubbing is on, the `myResult` variable will be assigned the value `Some result` and `myOutput1` will be

assigned the value of some output.

- If stubbing is off, the value returned by the Web Service will be stored in these two variables.

Limitation

Web Service stubbing currently does not support auto-synchronization of output parameters in case of Web Services with complex return types.

Web Service SOAP Messages

Use the examples below when configuring the [Web Service block](#).

SOAP Message Level Basic Authentication

```
<SOAP-ENV:Envelope xmlns:SOAP-ENV="http://schemas.xmlsoap.org/soap/envelope/">
  <SOAP-ENV:Header>
    <h:BasicAuth xmlns:h="http://soap-authentication.org/basic/2001/
10/" mustUnderstand="1">
      <Name>UserName</Name>
      <Password>Pass</Password>
    </h:BasicAuth>
  </SOAP-ENV:Header>
  <SOAP-ENV:Body>
    <p:getNumber xmlns:p="http://webservice.com"/>
  </SOAP-ENV:Body>
</SOAP-ENV:Envelope>
```

SOAP Message Signed Using Client Digital Certificate (DSA Key Algorithm)

```
<SOAP-ENV:Envelope xmlns:SOAP-ENV="http://schemas.xmlsoap.org/soap/envelope/">
<SOAP-ENV:Header>
<wsse:Security xmlns:wsse="http://docs.oasis-open.org/wss/2004/01/oasis-200401-wss-wssecurity-
secext-1.0.xsd" xmlns:wsu="http://docs.oasis-open.org/wss/2004/01/oasis-200401-wss-wssecurity-
utility-1.0.xsd" SOAP-ENV:mustUnderstand="1">
<ds:Signature xmlns:ds="http://www.w3.org/2000/09/xmldsig#" Id="SIG-2">
<ds:SignedInfo>
<ds:CanonicalizationMethod Algorithm="http://www.w3.org/2001/10/xml-exc-c14n#">
<ec:InclusiveNamespaces xmlns:ec="http://www.w3.org/2001/10/xml-exc-c14n#" PrefixList="SOAP-
ENV"/>
</ds:CanonicalizationMethod>
<ds:SignatureMethod Algorithm="http://www.w3.org/2000/09/xmldsig#dsa-sha1"/>
<ds:Reference URI="#id-1">
<ds:Transforms>
<ds:Transform Algorithm="http://www.w3.org/2001/10/xml-exc-c14n#"><ec:InclusiveNamespaces
xmlns:ec="http://www.w3.org/2001/10/xml-exc-c14n#" PrefixList=""/>
</ds:Transform>
</ds:Transforms>
<ds:DigestMethod Algorithm="http://www.w3.org/2000/09/
xmldsig#sha1"/><ds:DigestValue>yMmgdHRev0nFPGtnSZx4JV9hiuI=</ds:DigestValue></ds:Reference></ds:SignedInfo><ds:
Id="KI-8D7856F18A7AB8CF5613098009924472">
<wsse:SecurityTokenReference wsu:Id="STR-8D7856F18A7AB8CF5613098009924473">
<wsse:KeyIdentifier EncodingType="http://docs.oasis-open.org/wss/2004/01/oasis-200401-wss-
soap-message-security-1.0#Base64Binary" ValueType="http://docs.oasis-open.org/wss/2004/01/
oasis-200401-wss-x509-token-
profile-1.0#X509v3">MIICwDCCAn2gAwIBAgIETfBxZzALBgcqhkJ00AQDBQAwQzELMAkGA1UEBhMCVVMxDDAKBgNVBAoTA1N1bjERMA8GA1U
yZmC3a5lQpaSfn+gEexAiwk+7qdf+t8Yb+DtX58aophUPBPuD9tPFHsMCNVQTWhaRMvZ1864rYdcq7/
IiAxmd0UgBxwIVAjdGUl8VlwwMspK5gqLrhAvwWBz1A0GBAPfhoIXWmz3ey7yrXDa4V7l5lK+7+jrqgvLXTAs9B4JnUVlXjrrUWU/
```



```

mcQcQgYc0SRZxi+hMKBYTt88JMozIpuE8FnqLVHyNK0Cjrh4rs6Z1kW6jfwv6ITVi8ftiegEk08yk8b6oUZCJqIPf4VrlnwaSi2ZegHtVJWQBTD
5Ykhco6LMBRRncJwGuWB/mFPhaX80dfj8NMEih1+ICIjhVwGk1p6P3Gu2Dm+45TYJCxBktd0LU0uy/
Uj8E61NZSaeQL9WA4gGz5Hb5uMAsGByqGSM44BAMFAAMwADAtAhQqfbMb9hd1vpBAAJntCDSOY5uP2AIVAJGy1E7Zx4268n3fD34gLcPkZoKc</
</wsse:SecurityTokenReference>
</ds:KeyInfo>
</ds:Signature>
</wsse:Security>
</SOAP-ENV:Header>
<SOAP-ENV:Body xmlns:wsu="http://docs.oasis-open.org/wss/2004/01/oasis-200401-wss-wssecurity-
utility-1.0.xsd" wsu:Id="id-1">
<p:methodName xmlns:p="http://example.com"><key>value</key></p:methodName>
</SOAP-ENV:Body>
</SOAP-ENV:Envelope>

```

SOAP Message Signed Using Client Digital Certificate (RSA Key Algorithm)

```

<SOAP-ENV:Envelope xmlns:SOAP-ENV="http://schemas.xmlsoap.org/soap/envelope/">
<SOAP-ENV:Header>
<wsse:Security xmlns:wsse="http://docs.oasis-open.org/wss/2004/01/oasis-200401-wss-wssecurity-
secext-1.0.xsd" xmlns:wsu="http://docs.oasis-open.org/wss/2004/01/oasis-200401-wss-wssecurity-
utility-1.0.xsd" SOAP-ENV:mustUnderstand="1">
<ds:Signature xmlns:ds="http://www.w3.org/2000/09/xmldsig#" Id="SIG-2">
<ds:SignedInfo><ds:CanonicalizationMethod Algorithm="http://www.w3.org/2001/10/xml-exc-c14n#">
<ec:InclusiveNamespaces xmlns:ec="http://www.w3.org/2001/10/xml-exc-c14n#" PrefixList="SOAP-
ENV"/>
</ds:CanonicalizationMethod>
<ds:SignatureMethod Algorithm="http://www.w3.org/2000/09/xmldsig#rsa-sha1"/>
<ds:Reference URI="#id-1">
<ds:Transforms>
<ds:Transform Algorithm="http://www.w3.org/2001/10/xml-exc-c14n#"><ec:InclusiveNamespaces
xmlns:ec=
"http://www.w3.org/2001/10/xml-exc-c14n#" PrefixList=""/>
</ds:Transform>
</ds:Transforms>
<ds:DigestMethod Algorithm="http://www.w3.org/2000/09/xmldsig#sha1"/>
<ds:DigestValue>yMmgdHRevOnFPgtnSZx4JV9hiuI=
</ds:DigestValue>
</ds:Reference>
</ds:SignedInfo>
<ds:SignatureValue>MX9c9C5Tpfvp32e2pPjkCv4ycZhcuzVMFH08DlGKWi331fnG3oqXLg==</ds:SignatureValue>
<ds:KeyInfo Id="KI-8D7856F18A7AB8CF5613098009924472">
<wsse:SecurityTokenReference wsu:Id="STR-8D7856F18A7AB8CF5613098009924473">
<wsse:KeyIdentifier EncodingType="http://docs.oasis-open.org/wss/2004/01/oasis-200401-wss-
soap-message-security-1.0#Base64Binary" ValueType="http://docs.oasis-open.org/wss/2004/01/
oasis-200401-wss-x509-token-
profile-1.0#X509v3">MIICwDCCAn2gAwIBAgIETfBxZzALBgqhkJ00AQDBQAwQzELMAkGA1UEBhMCMVVMxDDAKBgNVBAoTA1N1bjERMA8GA1U
yZmC3a5LQpaSfn+gEexAiwk+7qdf+t8Yb+DtX58aophUPBPu9tPFHsMCNVQTWhaRMvZ1864rYdcq7/
IiAxmd0UgBxwIVAjdGUi8VlIwvMspK5ggLrhAvwWBz1AoGBAPfhoIXWmz3ey7yrXDa4V7l5lK+7+jrqqvLXTAs9B4JnUVLXjrrUWU/
mcQcQgYc0SRZxi+hMKBYTt88JMozIpuE8FnqLVHyNK0Cjrh4rs6Z1kW6jfwv6ITVi8ftiegEk08yk8b6oUZCJqIPf4VrlnwaSi2ZegHtVJWQBTD
5Ykhco6LMBRRncJwGuWB/mFPhaX80dfj8NMEih1+ICIjhVwGk1p6P3Gu2Dm+45TYJCxBktd0LU0uy/
Uj8E61NZSaeQL9WA4gGz5Hb5uMAsGByqGSM44BAMFAAMwADAtAhQqfbMb9hd1vpBAAJntCDSOY5uP2AIVAJGy1E7Zx4268n3fD34gLcPkZoKc</
</wsse:SecurityTokenReference>
</ds:KeyInfo>
</ds:Signature>
</wsse:Security>
</SOAP-ENV:Header>
<SOAP-ENV:Body xmlns:wsu="http://docs.oasis-open.org/wss/2004/01/oasis-200401-wss-wssecurity-

```

```
utility-1.0.xsd" wsu:Id="id-1">  
<p:methodName xmlns:p="http://example.com"><key>value</key></p:methodName>  
</SOAP-ENV:Body>  
</SOAP-ENV:Envelope>
```

Signed SOAP Requests

The Web Service block enables Composer applications to invoke Web Services, which require message-level authentication. The message level security support provided by the Web Service block is limited to one-way signed SOAP requests from the Composer application to the Web Service. Web Services can then verify that the request received from a Composer application includes a valid certificate.

Prerequisites

The prerequisites are:

- Web Service is able to verify only the signature (Timestamp, UsernameToken and Encryption are not supported).
- Web Service sends an unsigned response, i.e., Web Service is not configured to process outgoing response (only InflowSecurity is configured).
- X.509 certificate for the client is available and is trusted by the Web Service. Certificates can be purchased from a certificate authority or can be generated (for testing) using tools, such as OpenSSL.
- Certificates should be based on one of the supported encryption algorithms, RSA or DSA.
- Certificate Stores:
 - For Java projects, certificates and keys should be available in a Java Keystore (*.jks file). OpenSSL and Keytool (available in JDK 1.6) can be used to create and import certificates.
 - For .NET projects, certificates and keys should be available in the Windows Certificate Store. OpenSSL can be used to create certificates and Certificates (snap-in in Microsoft Management Console) can be used to import certificates.
- For .NET projects, WSE 3.0 (runtime) should be installed on the machine running Composer.

Enabling Signing of SOAP Messages

To enable signing of SOAP messages, set the Authentication Type property in the Security section to one of the following values

- SOAPDigitalSignatureAuthentication -- for signing messages when not using HTTP Basic authentication.
- SOAPSignatureWithHTTPBasicAuthentication -- for signing messages when used along with HTTP Basic Authentication (Security Basic Authentication Credentials section is specified)

Once enabled to sign the request, the application will need information regarding the public key (certificate) and private key (key) as below:

- Certificate Store Name (.NET only) -- Windows Store Name containing the client certificate and private key. Value should be one of the following predefined Windows Certificate Stores or the name of a

custom Store in which the certificate and key are stored. Note that this Store should contain the client certificate (should include the private key as well).

- AddressBook -- The X.509 Certificate Store for other users.
- My -- The X.509 Certificate Store for personal certificates.
- TrustedPeople -- The X.509 Certificate Store for directly trusted people and resources.
- Certificate Alias -- Alias that identifies the certificate and key in the Store. For .NET projects, this refers to the subject of the certificate, e.g., CN=ComposerCertificate.
- Certificate or Key Store Location -- Path to the Certificate Store location containing the certificate and private key. In .NET, the value should be set to one of the following:
- StoreLocation.LocalMachine (default when value is not one of these)
- StoreLocation.CurrentUser
- Key Algorithm -- Algorithm to be used for encryption. This is the same as the algorithm that was specified when the key was generated; usually received from the certificate authority issuing the certificate.
- Key Store Password (Java only) -- Java Key Store password for the key store specified as the key store location.
- Private Key Alias (Java only) -- Alias by which the private key is identified in the key store.
- Private Key Password (Java only) - Password to access the private key to be used when signing a message. For .NET projects, it is expected that the password be stored as part of the settings for the certificate.

At run time, the Composer application will create a SOAP message and then sign it using its private key. The signed message will include an encrypted signature in the SOAP header and the SOAP request as the body. This signed message is sent to the Web Service for processing. Web Service will decrypt the signature using the client certificate (public key previously imported into the Web Service certificate store) and hence authenticating that the source of the request is valid.

Signature Validation Failure Causes

Signature Validation by the Web Service may fail for the following reasons:

- Syntax of request (signature) doesn't conform to the policy enforced by the Web Service. Example: Timestamp is required by the Web Service but was not included in the request because Composer doesn't support Timestamp policy.
- Validation of signature failed. Example: Web Service uses RSA key, but the request was signed using DSA key.
- Application validation policy rejects the request. Example: Signature created by an untrusted key.

Once signature validation is successful, the Web Service will process the request and then send the unsigned response back to the Composer application. Composer processes the response without signature validation. The above will ensure that Web Services will process requests only from legitimate clients, the Composer application being one of them.

Connection and Read Timeout

By default, the Web Service and Web Request blocks use 20 seconds each for the connection timeout and read timeout. The following steps describe how to configure the timeouts:

1. Create a new folder called WEB-INF inside the Composer Project.
2. Create a property file named `composer.properties` inside the WEB-INF folder.
3. Add the following properties (case-sensitive) to `composer.properties` with the timeout values:

- `web.connectionTimeout=40000`
- `web.readTimeout=40000`

The value specified should be in milliseconds. The `connectionTimeout` property is a specified timeout value, in milliseconds, to be used when opening a communications link to the resource referenced by the URL. The `readTimeout` property is a nonzero integer value, in milliseconds, to be used when reading from an input stream when a connection is established to a URL resource.

Server-Side Troubleshooting

The table below lists Server Side block troubleshooting situations and steps to remedy.

Situation	Block	Steps to Troubleshoot
I entered the Service URL but getting a pop-up with Check the Web Service URL	Web Service Block	<p>Verify that the WSDL definition is accessible in a web browser.</p> <p>Check the Composer logs for possible errors in fetching the WSDL. Location: <workspace>\.metadata Check that the WSDL definition is accessible and test with the Web Services Explorer utility as described in the Troubleshooting section.</p>
I entered the Service URL and I can choose the SOAP operations, but the parameters do not show up in the dialogs	Web Service Block	<p>Verify that the WSDL definition is accessible in a web browser.</p> <p>Check the Composer logs for possible errors in fetching the WSDL. More details can be found in the logs in the following location: <workspace>\.metadata\plugins\com.genesyslab.studio.model folder Check that the WSDL definition is accessible and test with the Web Services Explorer utility as described in the Troubleshooting section.</p>
Using the Web Services Explorer utility	Web Service Block	<p>The Web Services Explorer is a JSP Web application hosted on the Apache Tomcat servlet engine contained within Eclipse. The Web Services Explorer is provided with Composer and allows you to explore, import, and test WSDL documents.</p> <p>Check that the WSDL definition is accessible and test with the Web Services Explorer utility as described in the Troubleshooting section.</p>
Errors during runtime	Web Service Block Web Request Block Backend Block	<p>Check the Composer logs for possible errors in fetching the WSDL.</p> <p>Check the backend logs. For ASP.NET projects, check the IIS logs For Java Projects, check the Tomcat standard logs. Check that the WSDL definition is accessible and test with the Web Services Explorer utility as described in the Troubleshooting section.</p>
I copied my callflow/workflow from one project to another but my Backend block does not work	Backend Block	<p>Check that any custom backend libraries or applications have also been copied to the new project.</p>

Backend block		
---------------	--	--

Logs:

- Java Composer Projects Server Side Backend logging can be controlled using the `log4j.xml` file present in the `$ComposerInstalledLocation\tomcat\lib` folder.
- For DotNetComposer Projects `web.config` file can be used to control the Server Side logging.
- Java Composer Projects exported as WAR files will have the `log4j.xml` bundled inside the `WEB-INF\lib` folder. If the `log4j.xml` configuration format is not working, you can add a `log4j.properties` in the `tomcat/webapps/<application name>/WEB-INF/classes` folder.

Notes:

- Service URL has to end with `wsdl` or `WSDL`
- Cannot use `-` or other reserved characters in the Entry block for a variable value. Enter the value directly in the input parameters dialog by typing the value in the Expression column as a string; example: `'atm near 37.771008, -122.41175'`

Important

Tomcat is no longer bundled with Composer beginning with version 8.1.561.30. You will be prompted to provide the Tomcat installed location when running the Composer installer.

Sample Applications and Templates

Composer provides a set of predefined Project templates (**File > New > Java Composer Project**) containing sample applications. You can either start off with a blank Project template or use one of the predefined templates as a starting point depending on the Project Type you select in the dialog box.

- [Project Templates](#)
- [Diagram_Templates](#)
- [GVP Voice Project Templates](#)
- [Integrated Voice Route Project Templates](#)
- [Routing Templates and Samples](#)
- [Context Services Template](#)
- [Database Query Result Template](#)
- [Forward_to External Resource Template](#)
- [Route After Autoresponse Template](#)
- [Routing Based on Variables Template](#)
- [Routing Based on Date and Time Sample](#)
- [Routing Based on a Statistic Sample](#)
- [Routing Based on Percent Allocation](#)
- [Routing Using Web Request Sample](#)

Other examples in this document (not supplied as templates):

- [Last Called Agent](#)
- [Service Level Routing](#)
- [How To: Automate an SMS Response to a Customer Call](#)

Note: The *Orchestration Developer's Guide* contains code examples for [SCXML-based routing applications](#).

Project Templates

To create a new Project using a template:

1. In Composer perspective, click the **Create a Java Composer Project** or **Create .NET Composer Project** in the toolbar. Or alternatively:
 - **File > New > Java Composer Project**, or
 - **File > New > .NET Composer Project**.
2. Specify the name of the Project. By default all Projects will be saved in your workspace location.
3. In the Project dialog box, type a name for your Project. If you want to save the Composer Project in your default workspace, select the Use default location check box. If not, clear the check box, click Browse, and navigate to the location where you wish to store the Project.
4. Select the Project type:
 - **Integrated Voice and Route**. Select to create a Project that contains both callflows and workflows that interact with each other. For example, a routing strategy that invokes a GVP voice application. For more information on both voice and routing applications, see [How Do Voice Applications Work](#) and [What Is a Routing Workflow](#), respectively.
 - **Voice**: Select to create a Project associated with the GVP 8.x. This type of Project may include callflows, and related server-side files. For more information on this type of Project, see topic, [How Do Voice Applications Work](#).
 - **Route**: Select to create a Project associated with the URS 8.x SCXML Engine/Interpreter. For more information on this type of Project, see topic, [What Is a Routing Workflow](#).
5. Click **Next**.
6. Expand the appropriate **Project Type** category and select a template for your application.
7. Click **Next**.
8. Select the Project Locale(s) to be used for prompts, grammars, and other locale-related resources.
9. Click **Finish**. The new Project folder set will be displayed in the Project Explorer.

Diagram Templates

You can save a diagram as a template and have it appear on the list of available templates when [creating a new callflow diagram](#) or [creating a new workflow diagram](#). Diagrams saved as templates can be exported to/imported from the file system.

Saving a Diagram as a Template

To save a diagram as a template:

1. In the Project Explorer, right-click the diagram in the Workflows or Callflows folder.
2. Select **Save <Callflow or Workflow> as Template**. The Add Template dialog box opens.
3. Name and describe the template.
4. Click **OK**. Upon a successful save the following message appears: Custom template added to your configuration.

Accessing Saved Diagram Templates

To view a diagram previously saved as template:

1. From the File menu, select **New <Callflow or Workflow> Diagram**. The New <Callflow or Workflow> dialog box opens. The template appears in the Main Workflow tab under Custom Templates.
2. Select the template and click one of the following:
 - **Next** to name the diagram, select the Project, and then click **Finish**.
 - **Finish** to keep the template name and save in the Workflows or Callflows folder under the current Project.

Removing a Diagram Template

To remove a diagram template from the Custom Templates list, use [Customization Manager](#).

Exporting a Diagram Template to the File System

To export a diagram to the file system or another user's Composer:

1. In the Project Explorer, right-click the diagram in the Workflows or Callflows folder.
2. Select **Export**. The Export dialog box opens.
3. Under General, select **File System** and click **Next**.
4. In the File System dialog box, select the folder containing the diagram(s).
5. On the right, click check boxes to indicate the diagrams (s) to export.
6. Opposite **To directory**, select the Composer installation to export to or Browse for the destination directory.
7. Under **Options**, select one of the following:
 - Overwrite existing files without warning
 - Create directory structure for files
 - Create only selected directories (default).
8. Click **Finish**.

Importing a Diagram Template

To import a diagram previously saved as a template:

1. In the Project Explorer, right-click the diagram in the Workflows or Callflows folder.
2. Select **Import**. The Import dialog box opens.
3. Under **General**, select **File System** and click **Next**.
4. In the File System dialog box, opposite **From directory**, click **Browse**.
5. Open the workspace directory followed by the Project folder.
6. Within the Project folder, select the Workflows folder that contains the template to import and click OK.
7. In the File System dialog box on the right, click check boxes to indicate the template(s) to import.
8. Opposite **Into folder**, browse for and select the folder to import into.
9. Under Options, select one of the following:
 - Overwrite existing files without warning
 - Create directory structure for files
 - Create only selected directories (default).
10. Click **Finish**.

Editing a Diagram Template

Use Customization Manager: **Window > Show View > Other > Customization Manager**. Select

Workflow Diagram Editor or **Callflow Diagram Editor**.

GVP Voice Project Templates

Composer provides Project templates for Genesys Voice Platform voice applications (**File > New > Java Composer Project**):

NBest Results Handling Project Template

This template demonstrates processing of NBest Results and confirming the user input. For example, in a voice application there may be cases where the application must clarify a user response, such as:

- A Speech Recognizer may return multiple results in the case of a noisy environment or indistinct pronunciation of words.
- Grammar complexities may cause the user's input to be ambiguous.

NBest processing logic helps a voice application to clarify user responses. The template is shown below.

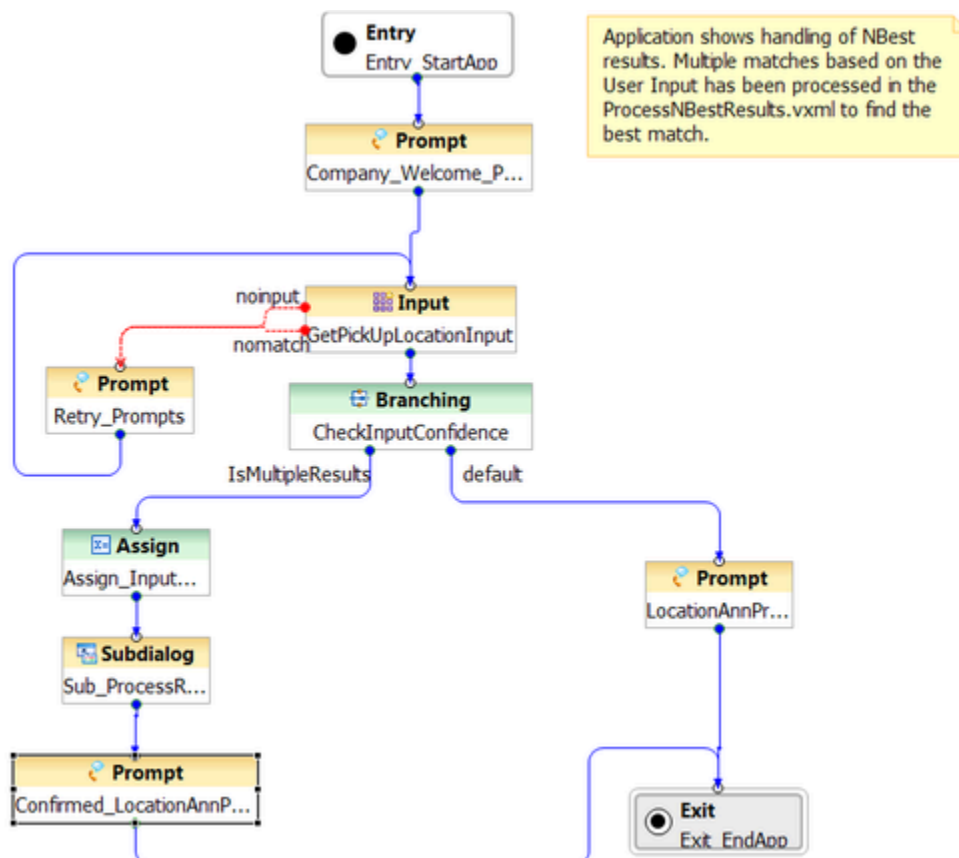

1. The Entry block enables NBest properties:

- Instructs the Speech Recognizer to return multiple results by setting `maxnbest` to an integer greater than one.
- Sets the `confidencelevel` decimal value (value values from 0.0 to 1.0) indicating the recognizer's confidence that the utterance matches what the user actually said.

2. An Input block Obtains the results:

- Instructs the user about the expected input details.
- An external grammar file will be used by the ASR engine to process the user input.
- Enables shadow variables.

3. A Branching block uses the Input block's shadow variable to check whether there are multiple results.

4. An Assign block assigns the obtained results to a variable:

- Creating a custom VXML page to process the multiple results array:
- Iterating over the Array to prompt the user about the results.
- Asking the user to confirm the exact result using a simple inline grammar.

5. A Subdialog block Invokes the NBest Processing VXML page:

- `ProcessNBestResults.vxml` has been placed inside the `src` directory.
- Passing the results (`LastResult` variable) as input for the VXML page.
- Defining an Output variable to receive the return result from the VXML page.

6. A Prompt block announces the user confirmation result.

Business Logic Project Template

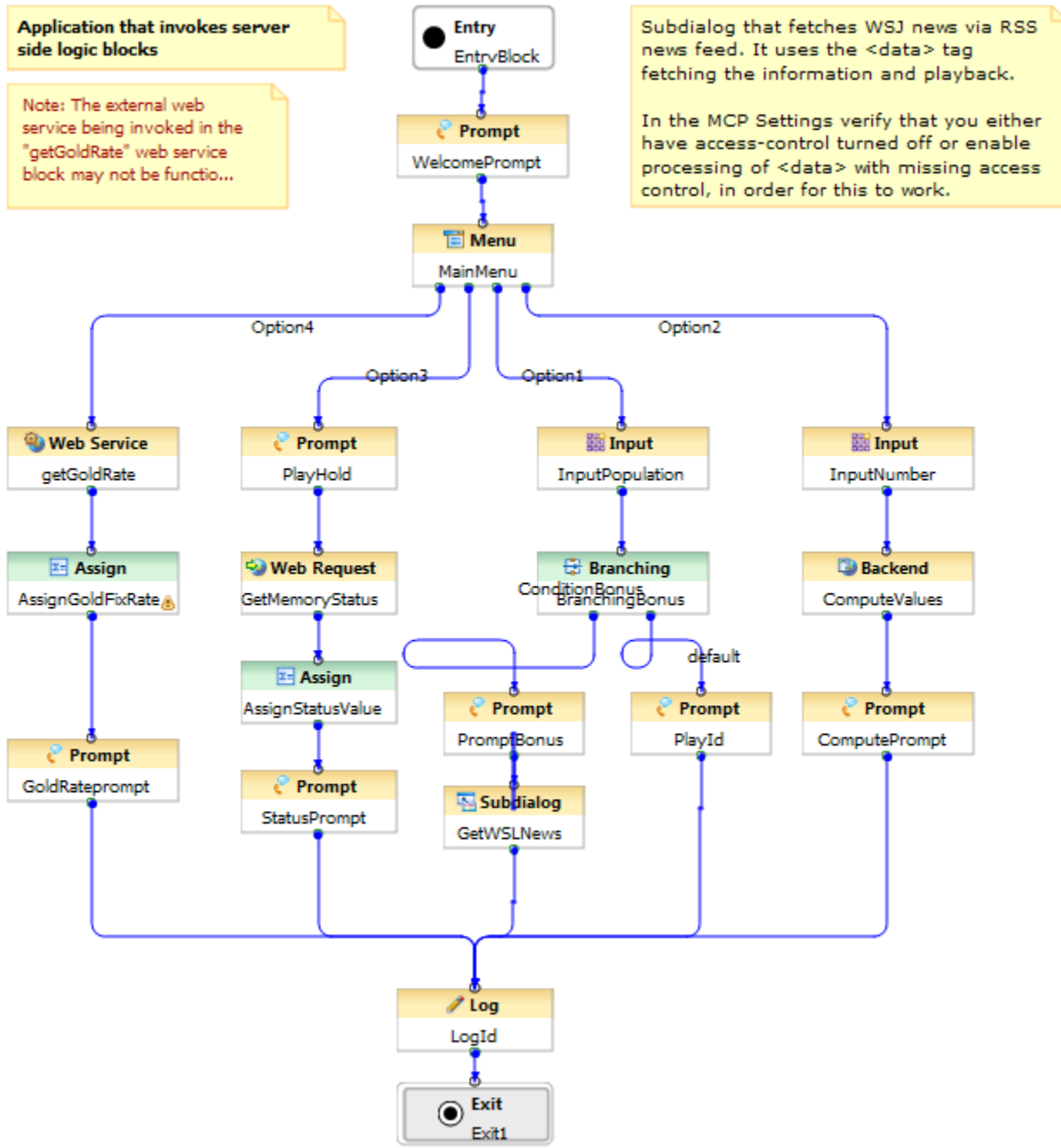

CCXML Project Template

This application is a typical CCXML application developed by using Composer. The CCXML app receives an incoming call and attempts to connect it to the target. Following the greeting prompts, the application will make an outbound call to "Bob." Bob will be asked if he can accept the call. Bob can enter DTMF 1 to accept the call and 2 to reject the call. If Bob accepts the call, the caller and Bob will be connected.

During development of this application, you can dial the following URL in a SIP phone to reach the application:

```
sip:ccxml@<IP of GVP ResourceManager>:<RM SIP port>;ccxml=http://<Web server address and port>/<project name>/src/main.ccxml
```

Note:

1. You must generate all the VoiceXML pages for all the callflow under Callflows before executing the call.
2. You must replace the "dest" attribute value ("bob@bobsphone:5060") in the following line in src/main.ccxml with the actual outbound call destination you want to reach:

```
<!-- the following call will land on the X-lite SIP softphone at port 5060 -->
<createcall dest="bob@bobsphone:5060"
connectionid="out_connectionid" />
```



Database Access Query Result Access Template

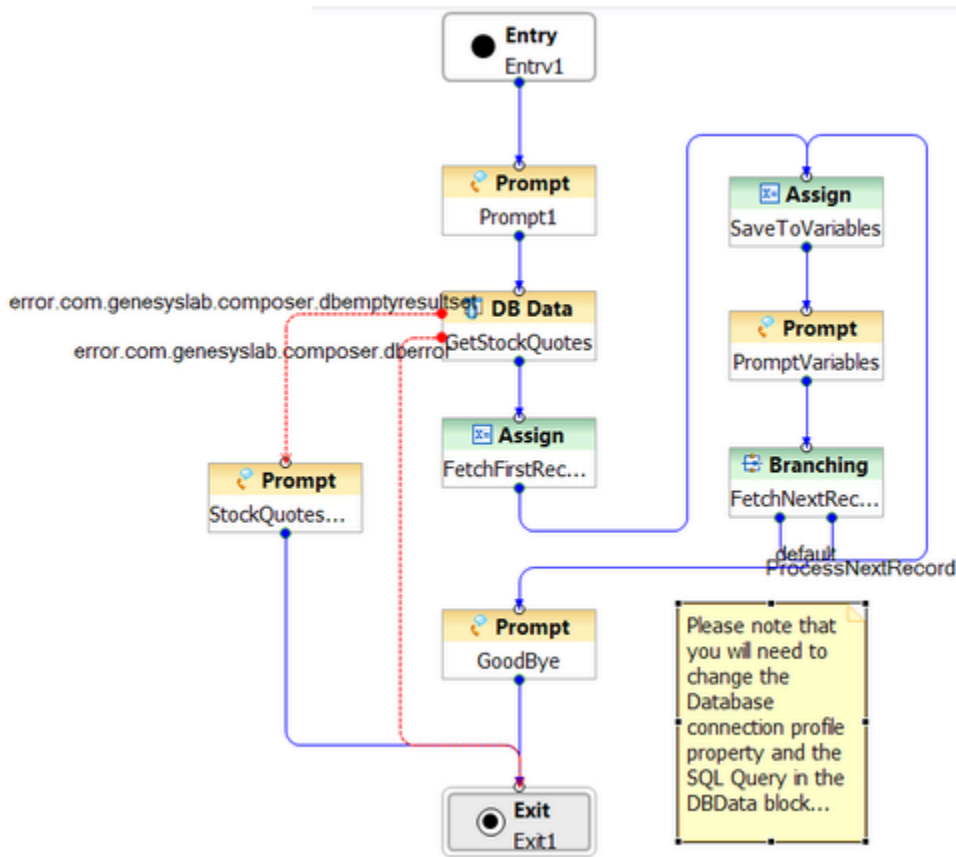

Transfer Project Template

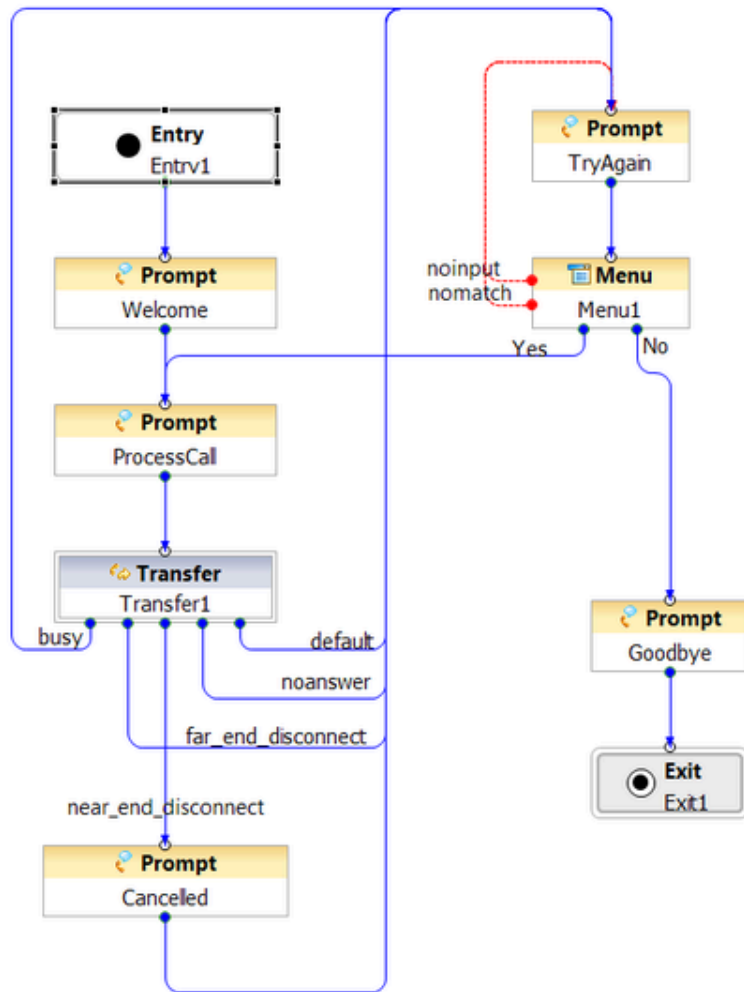

The application will transfer your call to a destination. At anytime during the introduction prompt, you can say "cancel" or press "9" to terminate the transfer. If transfer is canceled, you will be prompted to try again. Say "yes", or press "1" to try again and say "no" or press "0" to end the call.

The transfer destination is controlled by a Global Variable TransDest in the Entry Block. You must change its value to set the actual transfer destination you want to transfer to.

OSDM Project Template

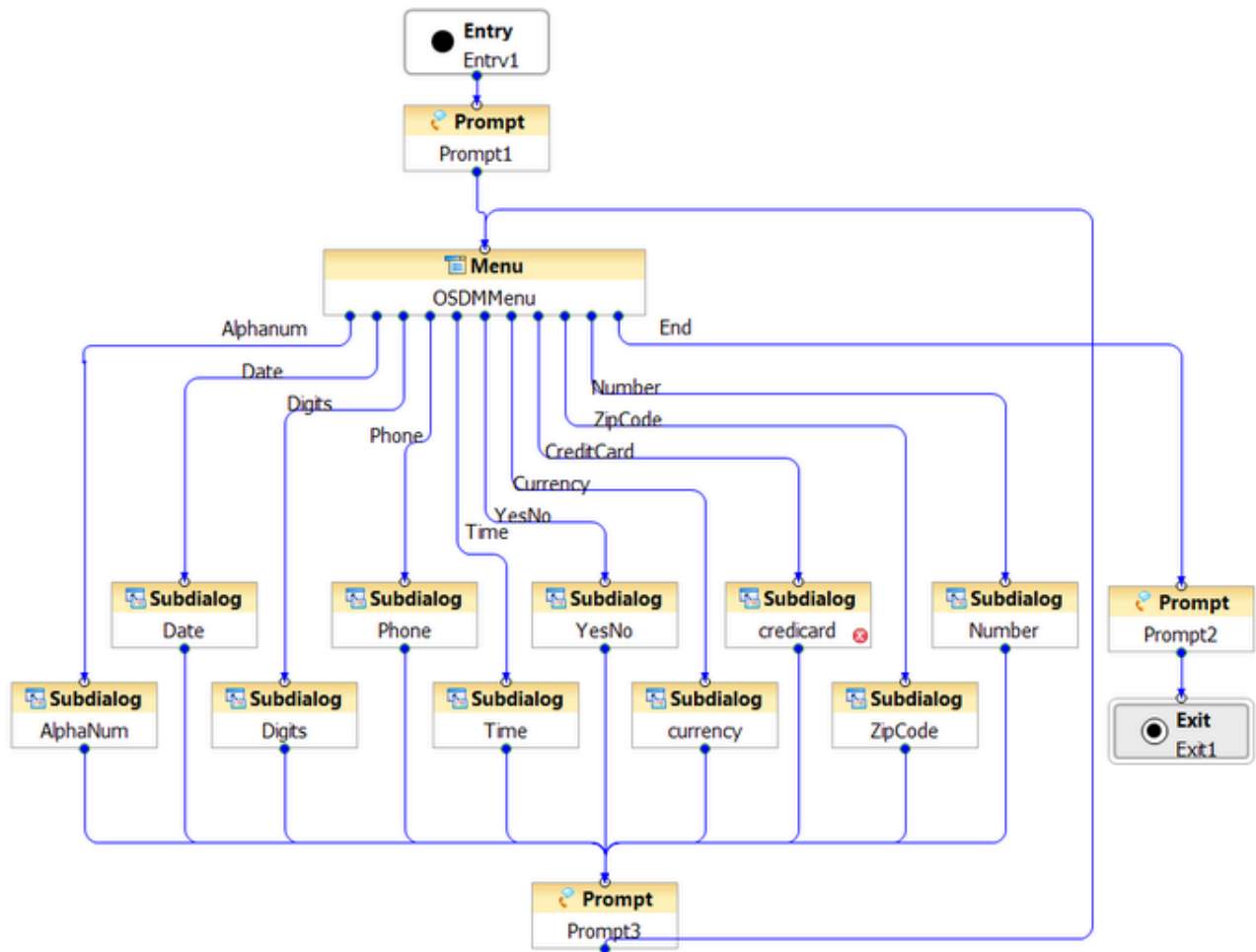

Transfer Project Template

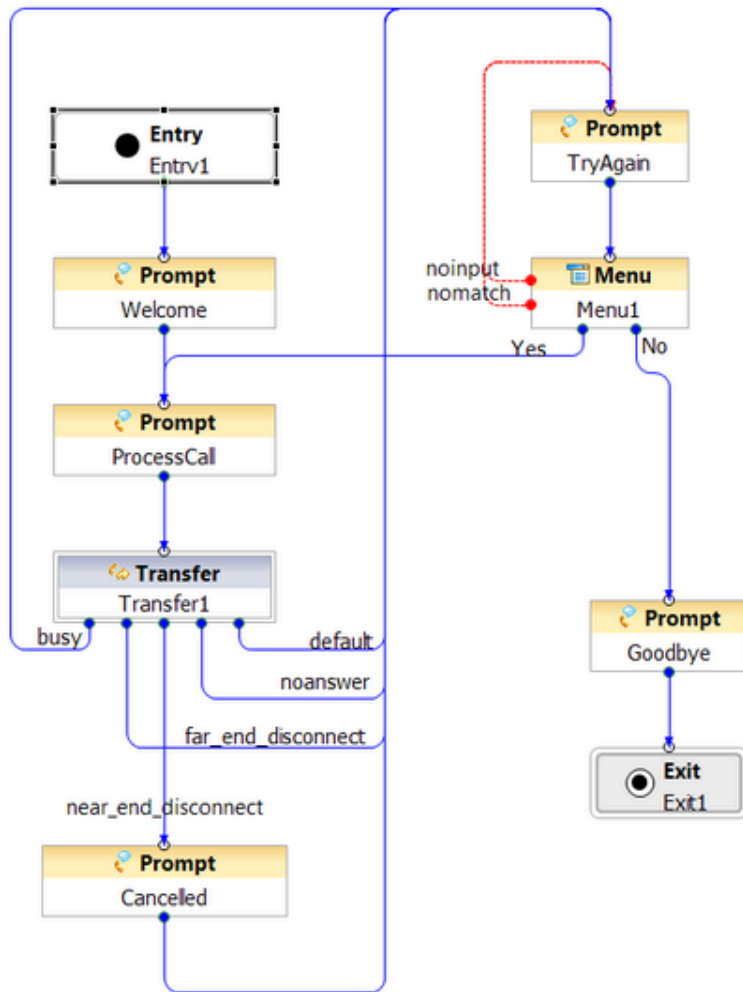

The application will transfer your call to a destination. At anytime during the introduction prompt, you can say "cancel" or press "9" to terminate the transfer. If transfer is canceled, you will be prompted to try again. Say "yes", or press "1" to try again and say "no" or press "0" to end the call.

The transfer destination is controlled by a Global Variable TransDest in the Entry Block. You must change its value to set the actual transfer destination you want to transfer to.

User Input Project Template

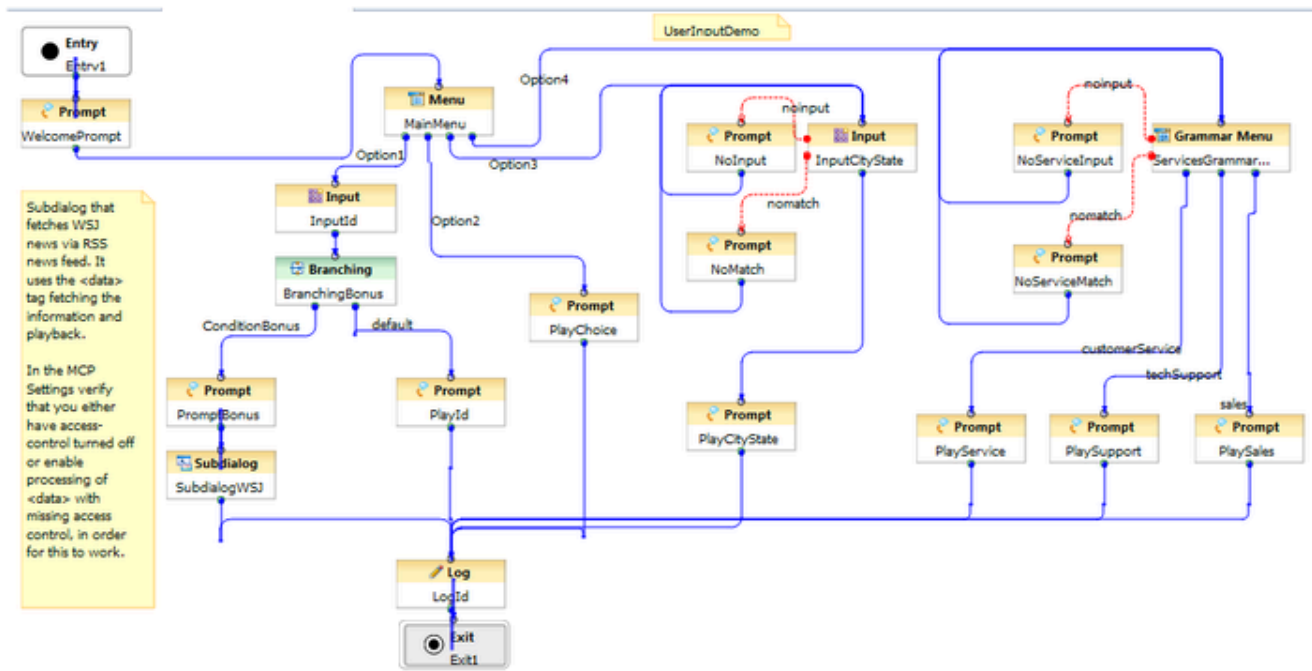

Voice Recording Project Template

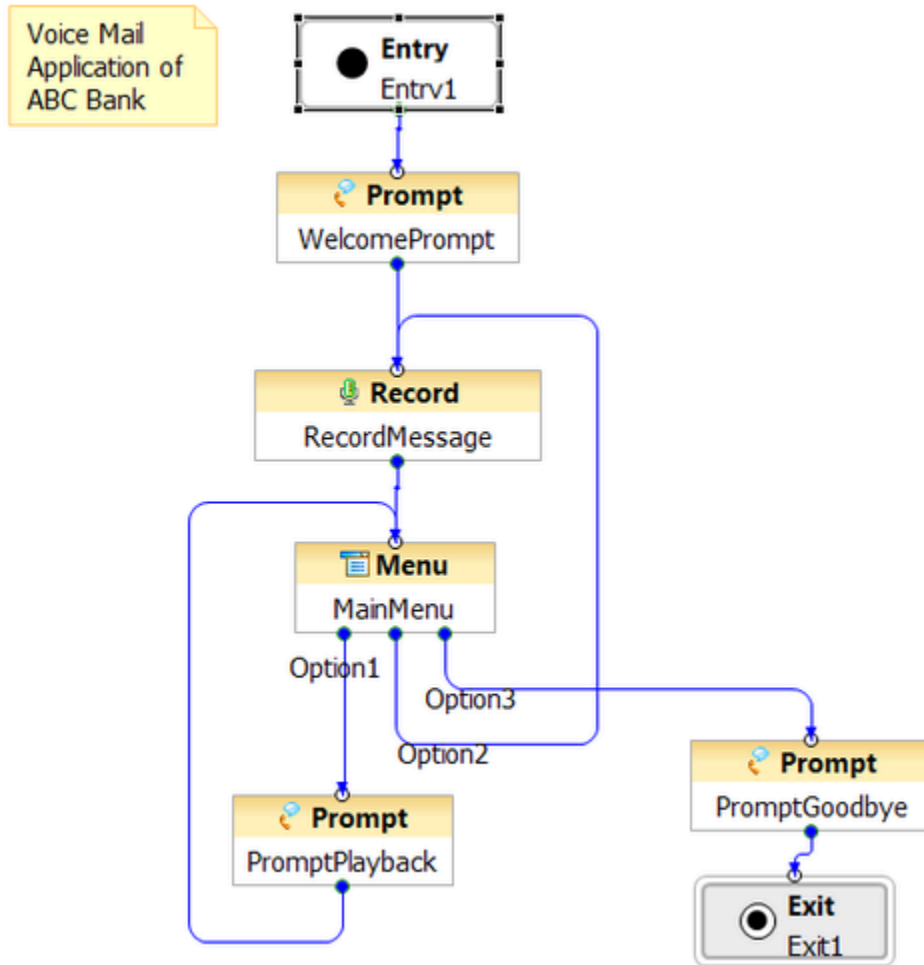

Application Metrics Collection Project Template

Composer provides Project templates for Genesys Voice Platform voice applications (**File > New > Java Composer Project**): In this template, added in 8.1.440.18, JavaScript metrics.js files capture and build metrics data in JSON format. The **Logging Details** property in the callflow diagram blocks are used to call the JavaScript methods. Diagrams are designed to use VAR blocks to provide insights on capturing VAR data. In addition to Project-specific files in the include, META-INFO, and scripts folders, the Project includes the following diagrams in the Callflows folder:

[+] Metrics.callflow

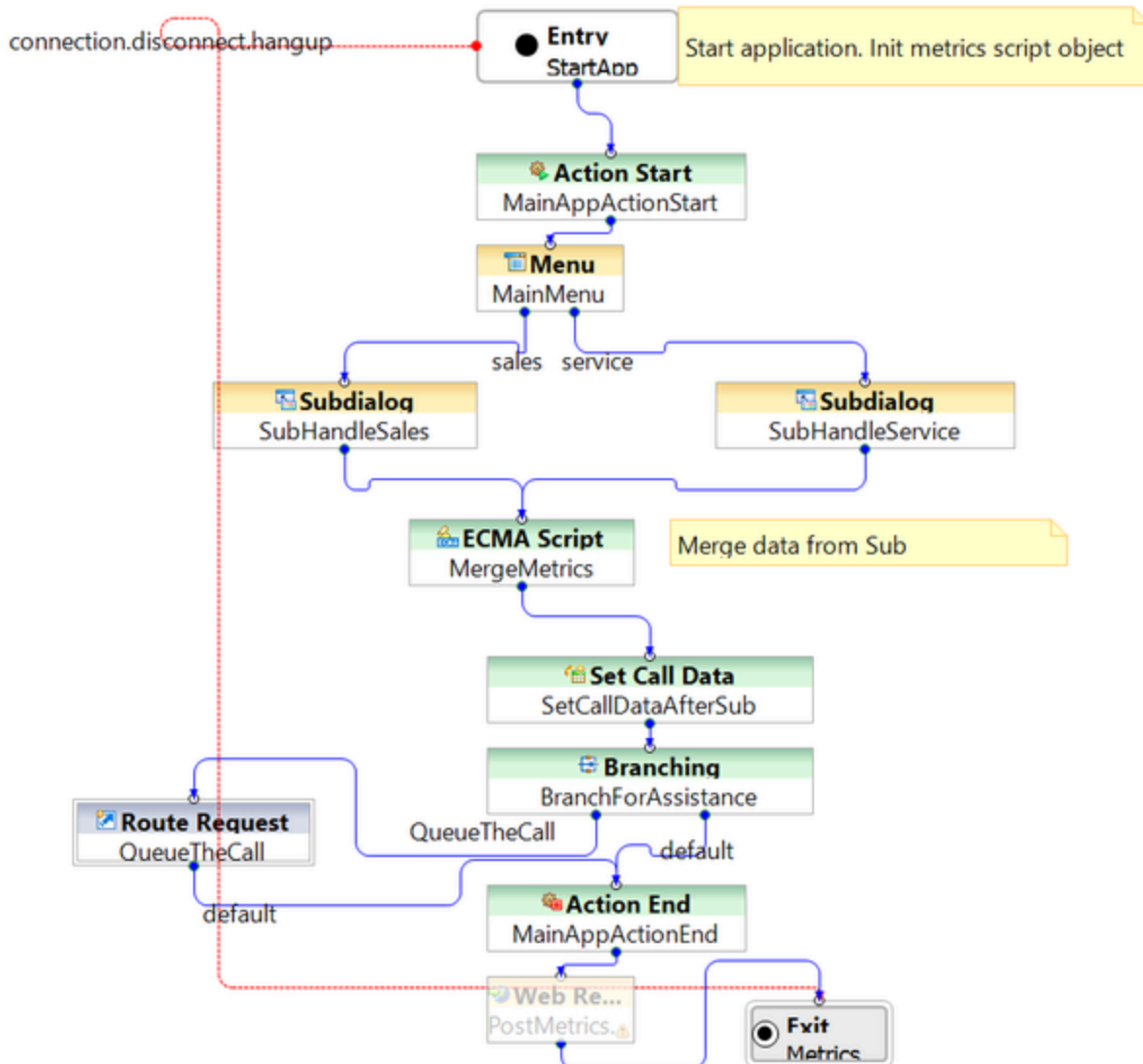

Main JS Methods:

- `initReportingData` - Initialize metrics object for each diagram file
- `finalizeReportingData` - Finalize the reporting data with latest set of variables
- `storeMetric` - Method to build metrics
- `getReportData` - Method to get final report in JSON format

Logging Details Properties for `Metrics.callflow` Calling the JavaScript Methods: StartApp block Logging Details

```
initReportingData(new Object(), AppState.varAppID, AppState.varAppName,
AppState.varAppVersion)
```

```
storeMetric(gMETRICS.BLOCK_ENTRY_TIME, 'Entry', 'StartApp', {})
```

Main Application Start block Logging Details

```
storeMetric(gMETRICS.BLOCK_ENTRY_TIME, 'VAR', 'MainAppActionStart', {});  
storeMetric(gMETRICS.ACTIVITY_START, 'VAR', 'MainAppActionStart', {'actionId':AppState.varMainAction, 'parentAction': 'MainMetrics'});
```

Main Menu block Logging Details

```
storeMetric(gMETRICS.BLOCK_ENTRY_TIME, 'MENU', 'MainMenu', {});
```

SubHandleSales block Logging Details

```
storeMetric(gMETRICS.BLOCK_ENTRY_TIME, 'SUBDIALOG', 'SubHandleSales', {})  
storeMetric(gMETRICS.APP_MILESTONES, 'SUBDIALOG', 'SubHandleSales', 'Main menu passed')
```

SubHandleService block Logging Details

```
storeMetric(gMETRICS.BLOCK_ENTRY_TIME, 'SUBDIALOG', 'SubHandleService', {})
```

Merge Metrics block Logging Details

```
storeMetric(gMETRICS.BLOCK_ENTRY_TIME, 'SCRIPT', 'MergeMetrics', {});  
storeMetric(gMETRICS.APP_MILESTONES, 'SCRIPT', 'MergeMetrics', 'Sub dialogs passed')
```

SetCallDataAfterSub block Logging Details

```
storeMetric(gMETRICS.BLOCK_ENTRY_TIME, 'CALldata', 'SetCallDataAfterSub', {})  
storeMetric(gMETRICS.CALL_DATA, 'CALldata', 'SetCallDataAfterSub', {'CustomVar0':AppState.varSubResult, 'CustomVar1':AppState.varMainMenu, 'CustomV
```

BranchforAssistance block Logging Details

```
storeMetric(gMETRICS.BLOCK_ENTRY_TIME, 'BRANCHING', 'BranchForAssistance', {})  
storeMetric(gMETRICS.APP_MILESTONES, 'BRANCHING', 'BranchForAssistance', 'Main branching passed')
```

QueueTheCall block Logging Details

```
storeMetric(gMETRICS.BLOCK_ENTRY_TIME, 'ROUTEREQUEST', 'QueueTheCall', {})
```

MainAppActionEnd block Logging Details

```
storeMetric(gMETRICS.BLOCK_ENTRY_TIME, 'VAR', 'MainAppActionEnd', {});  
storeMetric(gMETRICS.ACTIVITY_END, 'VAR', 'MainAppActionEnd', {'actionId':AppState.varMainAction, 'notes':'', 'reason':'', 'result':''});
```

PostMetricsData block
Json Content property, content placed in a variable.

[+] sub_sales.callflow

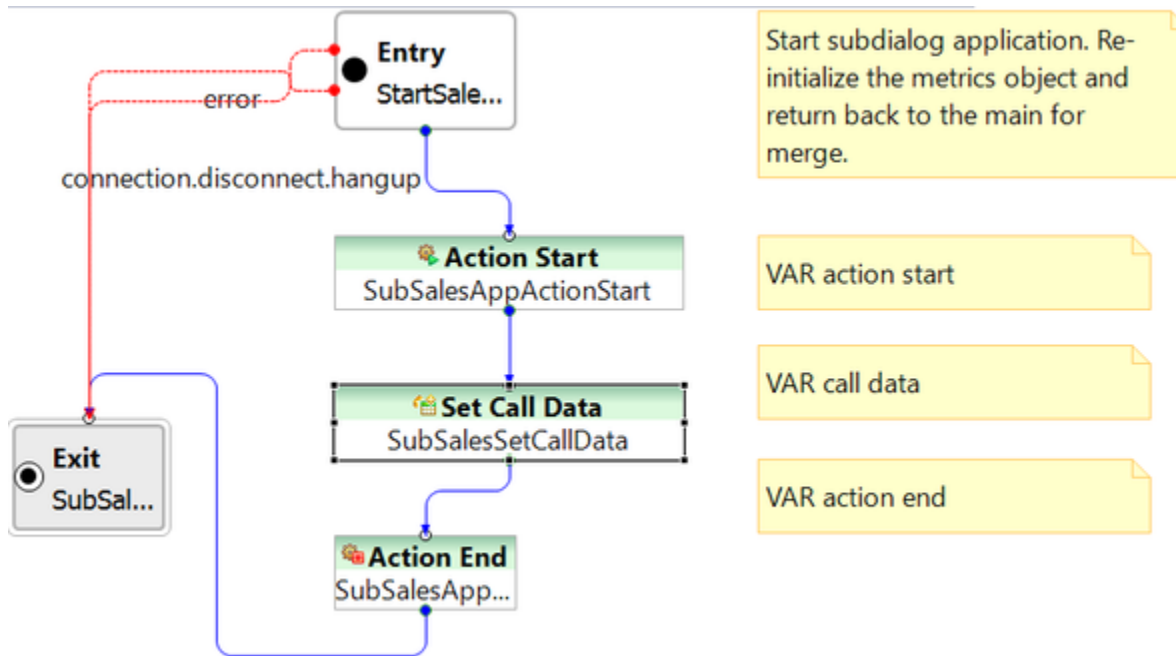

Start the subdialog application. Re-initialize the metrics object and return back to the main for merge.

Logging Details Properties for sub_sales.callflow that Call the JavaScript Methods:

StartSalesSubApp block Logging Details

```
initReportingData(new Object(), AppState.varAppID, AppState.varAppName,
AppState.varAppVersion)
```

```
storeMetric(gMETRICS.BLOCK_ENTRY_TIME, 'ENTRY', 'StartSalesSubApp', {});
```

SubSalesApplicationStart block Logging Details

```
storeMetric(gMETRICS.APP_MILESTONES, 'VAR', 'SubSalesAppActionStart', 'Sub dialog sales start')
```

```
storeMetric(gMETRICS.BLOCK_ENTRY_TIME, 'VAR', 'SubSalesAppActionStart', {})
```

```
storeMetric(gMETRICS.ACTIVITY_START,
'VAR', 'SubSalesAppActionStart', {'actionId': AppState.varSubSalesAction, 'parentAction': 'SubSales'});
```

SubSalesSetCall Data block Logging Details

```
storeMetric(gMETRICS.BLOCK_ENTRY_TIME, 'CALldata', 'SubSalesSetCallData', {})
```

```
storeMetric(gMETRICS.CALL_DATA,
'CALldata', 'SubSalesSetCallData', {'CustomVar2': AppState.ANI, 'CustomVar3': AppState.DNIS, 'CustomVar4': AppState.AP
```

SubSalesAppActionEnd block Logging Details

```
storeMetric(gMETRICS.BLOCK_ENTRY_TIME, 'VAR', 'SubSalesAppActionEnd', {});
```

```
storeMetric(gMETRICS.ACTIVITY_END, 'VAR', 'SubSalesAppActionEnd',
{'actionId': AppState.varSubSalesAction, 'notes': '', 'reason': '', 'result': ''});
```

```
storeMetric(gMETRICS.APP_MILESTONES, 'VAR', 'SubSalesAppActionStart', 'Sub Sales service end')
```

[+] sub_service.callflow

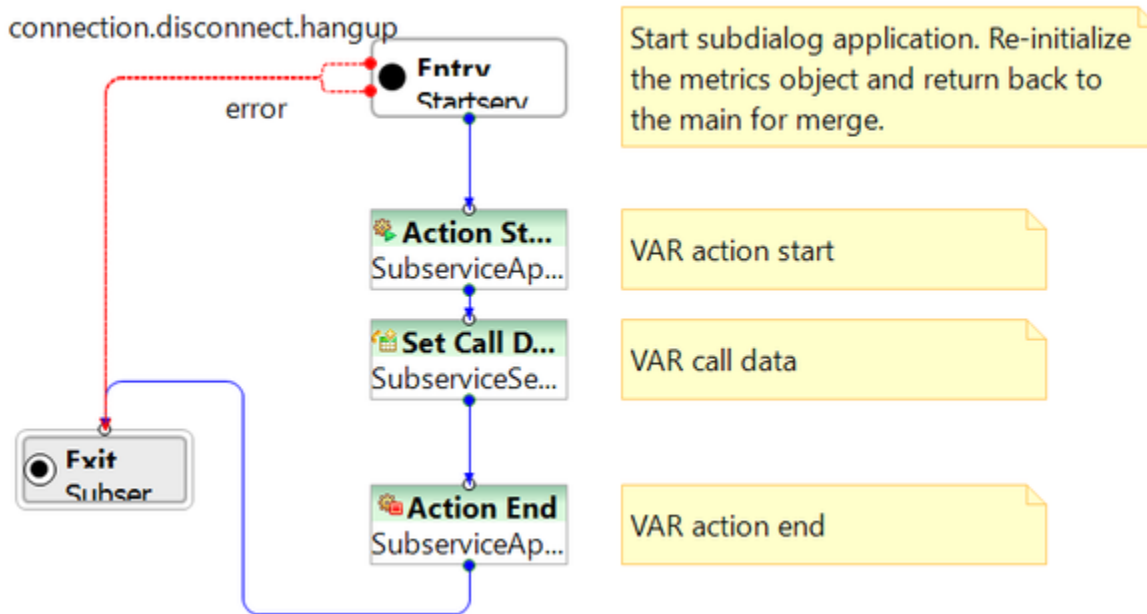

Start the subdialog application. Re-initialize the metrics object and return back to the main for merge.

Logging Details Properties for sub_service.callflow Calling the JavaScript Methods:

StartServiceSubApp block Logging Details

```
initReportingData(new Object(), AppState.varAppID, AppState.varAppName,
AppState.varAppVersion)
```

```
storeMetric(gMETRICS.BLOCK_ENTRY_TIME, 'ENTRY', 'StartserviceSubApp', {});
```

SubServiceApplicationStart block Logging Details

```
storeMetric(gMETRICS.APP_MILESTONES, 'VAR', 'SubserviceAppActionStart', 'Sub dialog service
start')
```

```
storeMetric(gMETRICS.BLOCK_ENTRY_TIME, 'VAR', 'SubserviceAppActionStart', {})
```

```
storeMetric(gMETRICS.ACTIVITY_START,
'VAR', 'SubserviceAppActionStart', {'actionId': AppState.varSubserviceAction, 'parentAction': 'Subservice'})
```

SubServiceSetCall Data block Logging Details

```
storeMetric(gMETRICS.BLOCK_ENTRY_TIME, 'CALldata', 'SubserviceSetCallData', {})
```

```
storeMetric(gMETRICS.CALL_DATA,
'CALldata', 'SubserviceSetCallData', {'CustomVar2':AppState.ANI, 'CustomVar3':AppState.DNIS, 'CustomVar4':AppState.
```

SubServiceAppActionEnd block Logging Details

```
storeMetric(gMETRICS.BLOCK_ENTRY_TIME, 'VAR', 'SubserviceAppActionEnd', {});

storeMetric(gMETRICS.ACTIVITY_END, 'VAR', 'SubserviceAppActionEnd',
{'actionId':AppState.varSubserviceAction, 'notes':'', 'reason':'', 'result':''});

storeMetric(gMETRICS.APP_MILESTONES, 'VAR', 'SubserviceAppActionStart', 'Sub dialog service
end')
```

[+] sample data

```
.
{
  "externalrequests": [],
  "dtmfpath": "0",
  "milestones": ["Main menu passed", "Sub dialogs passed", "Sub dialog sales start",
"Sub Sales service end", "Main branching passed"],
  "activities": [{
    "activity": "Main Application",
    "parent": "MainMetrics",
    "entry": {
      "blockName": "MainAppActionStart",
      "time": "2017-01-31T23:55:24.823Z"
    },
    "exit": {
      "blockName": "MainAppActionEnd",
      "time": "2017-01-31T23:56:01.250Z"
    },
    "notes": "",
    "reason": "",
    "result": "",
    "seq": 1
  }, {
    "activity": "Subdialog for Sales",
    "parent": "SubSales",
    "entry": {
      "blockName": "SubSalesAppActionStart",
      "time": "2017-01-31T23:55:23.615Z"
    },
    "exit": {
      "blockName": "SubSalesAppActionEnd",
      "time": "2017-01-31T23:55:23.615Z"
    },
    "notes": "",
    "reason": "",
    "result": "",
    "seq": 2
  }],
  "menucount": 1,
  "inputcount": 0,
  "variables": {
    "System": "{\"RetainInputTypeVariableDefaultValue\":false}",
```

```

"ANI": "4444",
"DNIS": "dialog",
"USE_LCASE_USERDATAKEY": "0",
"GVPSessionID": "undefined",
"g_CTICCall": "false",
"APP_ASR_LANGUAGE": "en-US",
"APP_LANGUAGE": "en-US",
"COMPOSER_WSSTUBBING": "0",
"EnableFCR": "true",
"EnableReports": "false",
"EnableSNMP": "false",
"GRAMMARFILEDIR": "../Resources/Grammars",
"LAST_EVENT_ELEMENT": "undefined",
"LAST_EVENT_LINE": "undefined",
"LAST_EVENT_MSG": "undefined",
"LAST_EVENT_NAME": "undefined",
"LAST_EVENT_URL": "undefined",
"PREV_APP_ASR_LANGUAGE": "undefined",
"PREV_APP_LANGUAGE": "undefined",
"SCRIPTSDIR": "../Scripts",
"varAppID": "b9768280-f518-11e5-9481-a98d7c98c257",
"varAppName": "MetricsDemo",
"varAppVersion": "1.0",
"varMainAction": "Main Application",
"varMainMenu": "0",
"VOXFILEDIR": "../Resources/Prompts",
"varQueueDN": "1234",
"varSubResult": "false",
"varCollectSubMetric": ""
},
"blocks": [{
  "type": "Entry",
  "name": "StartApp",
  "entry_time": "2017-01-31T23:55:23.615Z"
}, {
  "type": "EXIT",
  "name": "SubSalesExit",
  "entry_time": "2017-01-31T23:55:23.615Z"
}, {
  "type": "VAR",
  "name": "MainAppActionStart",
  "entry_time": "2017-01-31T23:55:24.576Z"
}, {
  "type": "MENU",
  "name": "MainMenu",
  "entry_time": "2017-01-31T23:55:26.073Z"
}, {
  "type": "ENTRY",
  "name": "StartSalesSubApp",
  "entry_time": "2017-01-31T23:55:23.615Z"
}, {
  "type": "VAR",
  "name": "SubSalesAppActionStart",
  "entry_time": "2017-01-31T23:55:23.615Z"
}, {
  "type": "CALldata",
  "name": "SubSalesSetCallData",
  "entry_time": "2017-01-31T23:55:23.615Z"
}, {
  "type": "VAR",
  "name": "SubSalesAppActionEnd",
  "entry_time": "2017-01-31T23:55:23.615Z"
}, {

```

```

        "type": "SUBDIALOG",
        "name": "SubHandleSales",
        "entry_time": "2017-01-31T23:55:38.228Z"
    }, {
        "type": "SCRIPT",
        "name": "MergeMetrics",
        "entry_time": "2017-01-31T23:55:54.163Z"
    }, {
        "type": "CALldata",
        "name": "SetCallDataAfterSub",
        "entry_time": "2017-01-31T23:55:55.360Z"
    }, {
        "type": "VAR",
        "name": "MainAppActionEnd",
        "entry_time": "2017-01-31T23:56:00.988Z"
    }, {
        "type": "BRANCHING",
        "name": "BranchForAssistance",
        "entry_time": "2017-01-31T23:55:59.547Z"
    }, {
        "type": "EXIT",
        "name": "MetricsMainExit",
        "entry_time": "2017-01-31T23:56:02.941Z"
    }
  ],
  "calldata": [
    {
      "variables":
        "{ \"CustomVar2\": \"4444\", \"CustomVar3\": \"dialog\", \"CustomVar4\": \"en-US\" }",
      "entry": {
        "blockName": "SubSalesSetCallData",
        "time": 1485906946093
      }
    }, {
      "variables":
        "{ \"CustomVar0\": false, \"CustomVar1\": \"0\", \"CustomVar2\": \"4444\", \"CustomVar3\": \"dialog\", \"CustomVar4\": \"en-US\", \"CustomVar5\": \"b9768280-f518-11e5-9481-a98d7c98c257\" }",
      "entry": {
        "blockName": "SetCallDataAfterSub",
        "time": 1485906955609
      }
    }
  ],
  "@timestamp": "2017-01-31T23:55:23.340Z",
  "utcstart": 1485906923340,
  "applicationID": "b9768280-f518-11e5-9481-a98d7c98c257",
  "applicationName": "MetricsDemo",
  "applicationVersion": "1.0",
  "@endtime": "2017-01-31T23:56:03.177Z",
  "duration": "39837",
  "activitycount": 2,
  "extreqcount": 0,
  "udata": {
    "Composer-Debug": "rItilZQ6wM"
  }
}

```

For information about GVP metrics (VoiceXML and CCXML application event logs), see the [GVP 8.1 Metrics Reference Guide](#)

Integrated Voice Route Project Templates

You can create an Integrated Voice (**GVP**) and Routing (**Orchestration**) application based on a Project template. A few of the supplied samples are described below. Also see the video [Integrated Voice and Route Application](#).

External File-Based Routing Template

This template demonstrates voice call routing based on criteria contained in an external file.

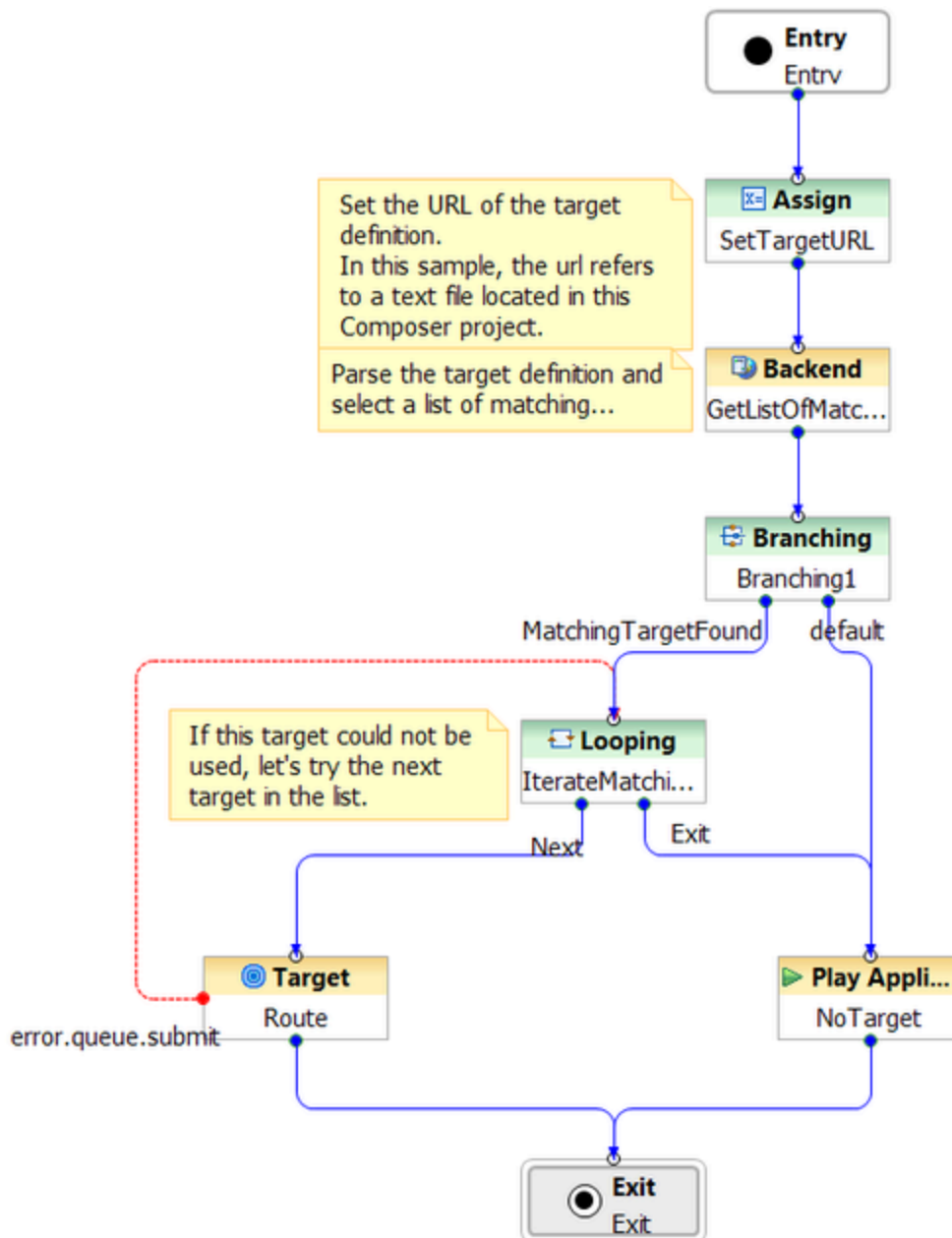

1. The IPD contains a single Workflow block pointing to a workflow diagram named default.workflow.
2. The default.workflow diagram starts with an Assign block that sets the URL of the target definition. In this case, the target definition (routing criteria and target preferences) is defined in the target.txt file contained in the src folder of the Project (but which could be defined in a file external to the Project). Routing target preferences are based on criteria such as the number dialed (DNIS), whether the inquiry is about home or auto insurance, the caller's language, claim history, discount percentage, and so on. Calls will be routed to various agent groups/queues based this information, which is assumed to be contained in the user data of the voice interaction.

3. The next block in the default.workflow diagram is a **Backend block**, which is used for invoking custom backend Java Server Pages; in this case, to execute the routing logic. Using the target.txt file DNIS criteria, the Backend block parses the target definition and selects a list of matching targets that could be routed to.
4. A **Branching block** then segments interactions to take different paths in the workflow.
 - If a matching target is found, the Branching block sends the voice interaction to a Looping block, which iterates until an exit condition is met; in this case, when an available target is found, which could be an agent, agent group, or the result of a Skill Expression.
 - If repeated Looping block iterations do not find an available target, the voice interaction goes to a **PlayApplicationblock**, which could inform the caller that all agents are busy and to call back later.

Load Balancing and Working Hour Routing Template

The template is shown below. For a video tutorial on this template, see [Integrated Voice and Route Application](#).

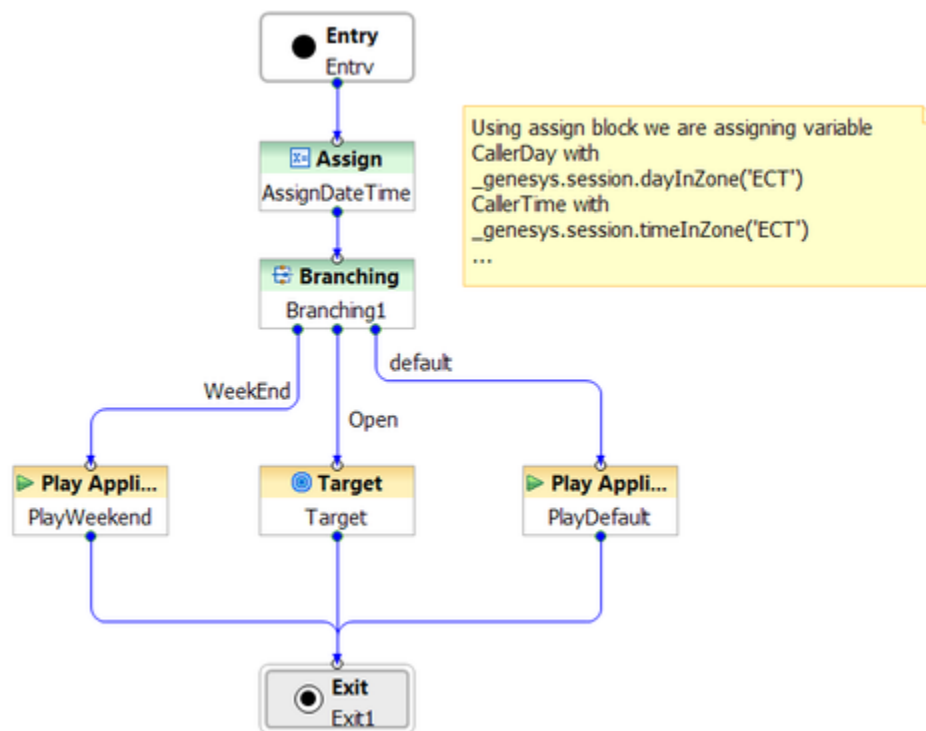

The **Assign Block** assigns the following variables:

- CallerDay using the Orchestration Server function available in **ExpressionBuilder** called `_genesys.session.dayInZone('ECT')`
- CallerTime using the Universal Routing Server functions available in Expression Builder called

```
_genesys.session.timeInZone('ECT')
```

Next, a **Branching block** checks for the following conditions:

- If CallerDay is Saturday or Sunday, then a **Play Application block** play the Weekend message to the caller.
- If CallerDay is a week day and CallerTime is after business hours, then a Play Application block plays the After Business Hours message to the caller.
- If CallerDay is a week day and CallerTime is within business hours, then a **Target block** is used to load balance calls between two agent groups.

Play Application & Busy Treatment Template

The template is shown below.

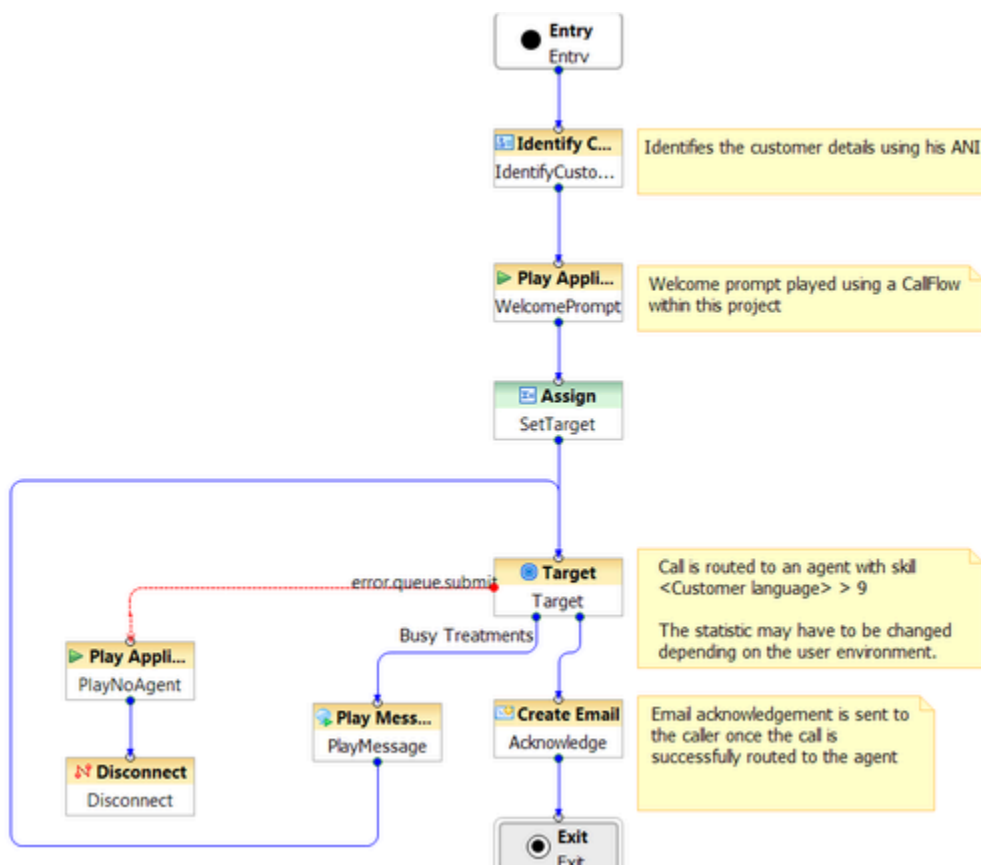

After the Entry block, this sample starts with an **Identify Customer block** that attempts to identify the calling customer in the Universal Contact Server Database based on the calling party's number stored in the ANI variable defined in the Entry block. The Customer Attributes property specifies to search/retrieve **core customer profile** attributes for the phone number.

1. A **Log block** logs customer information retrieved from the database. The Logging Details property specifies a JSON string for the format of the customer data.
2. A **Play Application block** plays a welcome message to the caller. The Language property indicates the customer's language is English. The Parameters property specifies the customer's first and last name from the JSON string.
3. A **Target block** routes the call based on a skill expression to a target with an English skill greater than 9 and a Spanish skill greater than 5.
4. If there are no available routing targets, a **Play Message block** plays a message to the caller. The Prompts property defines an expression (created in **Expression Builder**) that calls an **Orchestration Server function** (`_genesys.statistic.sData`). This function returns the value of a statistic (`ExpectedWaitTime`) for a specified object, in this case, a Skill Expression. This could be announced to the caller via an IVR application while waiting for a target.
5. Once the call is successfully routed to an agent, a **Create E-mail block** creates an acknowledgement e-mail to the customer in the form of pre-written text from the Standard Response library (see **eServices Help for Knowledge Manager**). The customer's e-mail address is contained in the `customeremail` variable defined in Entry block.

Routing Based on DNIS and ANI Template

The template is shown below.

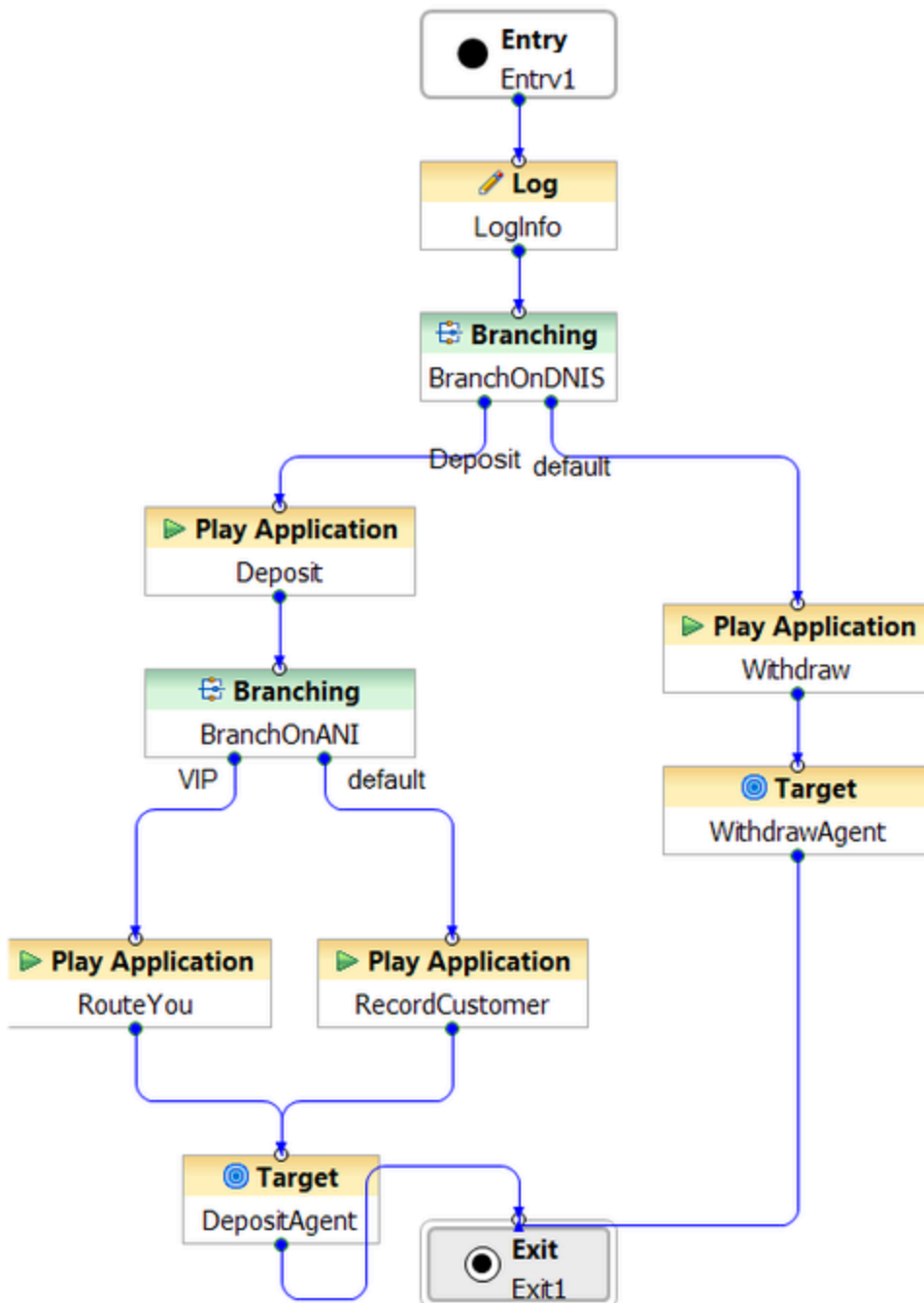

This template demonstrates how the originating phone number (ANI) and dialed phone number (DNIS) values are automatically made available as variables when you create a workflow.

1. The BranchOnDNIS block first checks if the incoming call was made to the DNIS for making a deposit.
2. If the call was not made to the deposit DNIS, the application will play a voice treatment before routing to the withdraw agent. The Withdraw Play Application block points to a voice callflow in the Composer Project. This will execute a VXML page which plays a message to the caller. The WithdrawAgent Target

block routes the call to the agent responsible for handling withdrawals.

3. If the DNIS did match the one for deposit, the application first plays an application treatment with a message for the caller. It will then examine the ANI of the caller in the BranchOnANI block, which contains the following branching condition: ANI==Customer. In this case, "Customer" is a variable declared in the Entry block of the workflow, and it can be modified to specify the ANI of the "special" customer that you are targeting.
4. The special customer is then routed directly to the agent handling deposits. Non-special customers must go through a voice treatment which records their name before proceeding. The voice treatment is executed by the RecordCustomer Play Application block.
5. A voice callflow is then executed by the RecordCustomer block. After recording the user's name, the Menu block provides the option to listen to the recording, re-record the audio, or exit. Upon exiting the voice treatment, the call will be routed to the deposit agent.

Routing Templates and Samples

This section leads you through some Composer-supplied templates that you can save and modify to create your own routing applications. It also presents samples, which are not part of Composer's collection of templates.

Composer provides the following Route Project templates:

- [Context Services Template](#)
- [Database Query Result Template](#)
- [Forward to External Resource Template](#)
- [Route After Autoresponse Template](#)
- [Routing Based on Variables Template](#)
- [Routing by Using Web Request Template](#)
- [Routing Based on Date and Time Sample](#)
- [Routing Based on a Statistic Sample](#)
- [Routing Based on Percent Allocation](#)
- [Routing Using Web Request Sample](#)
- [Last Called Agent](#)

To access the Project templates:

1. Switch to Composer Design or Composer [perspective](#).
2. Select File > New > Java Composer Project.
3. In the Project dialog box, name your Project and indicate whether you want to use the default location.
4. Select the Project type: Route.
5. Click Next. The Select a Composer Project Template dialog box opens.
6. Select a template and click Next.
7. Select the Project locale and click Finish.

Reviewing a Route Project Template

Assume you selected the Context Services Project in step 6 above. This automatically creates an [interaction process diagram](#) for routing interactions with a single [Workflow block](#) in the default.ixnprocess tab.

1. Double-click the Workflow block to open the Properties view in the tab underneath

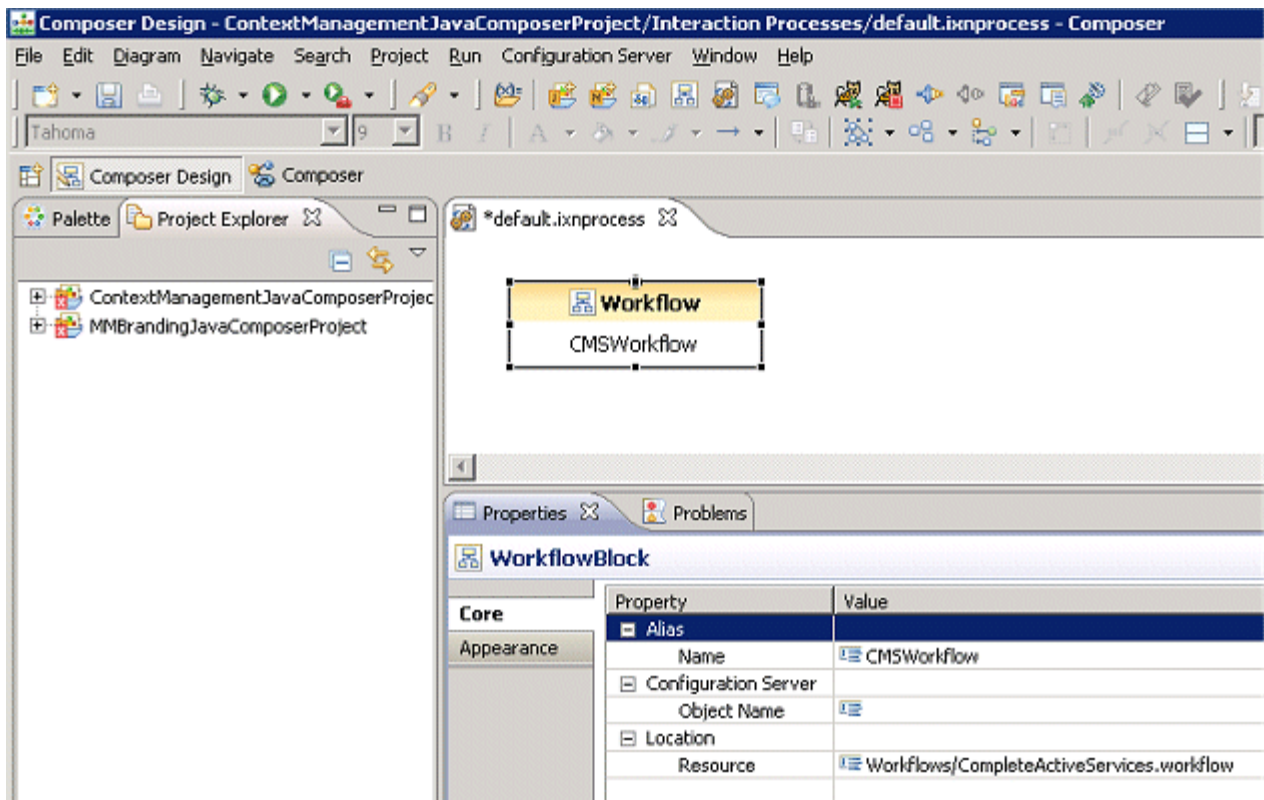

2. In the Properties view, note that the Resource property indicates that the name of the workflow is CompleteActiveServices.workflow.
3. To view this workflow, expand the Project in the Project Explorer.
4. Expand the Workflows folder.
5. Double-click CompleteActiveServices.workflow. A commented workflow appears.
6. View the properties for each block by double-clicking the block.

Context Services Template

This template demonstrates the use of Context Services blocks in various workflows. An interaction with a customer can be interrupted for various reasons -- the customer hanging up, a lost connection, and so on. When the customer calls back to the contact center, the interrupted services can be retrieved and completed. This sample contains workflows that demonstrate completing an active service, resuming a service, and updating the customer profile.

Complete Active Service Workflow

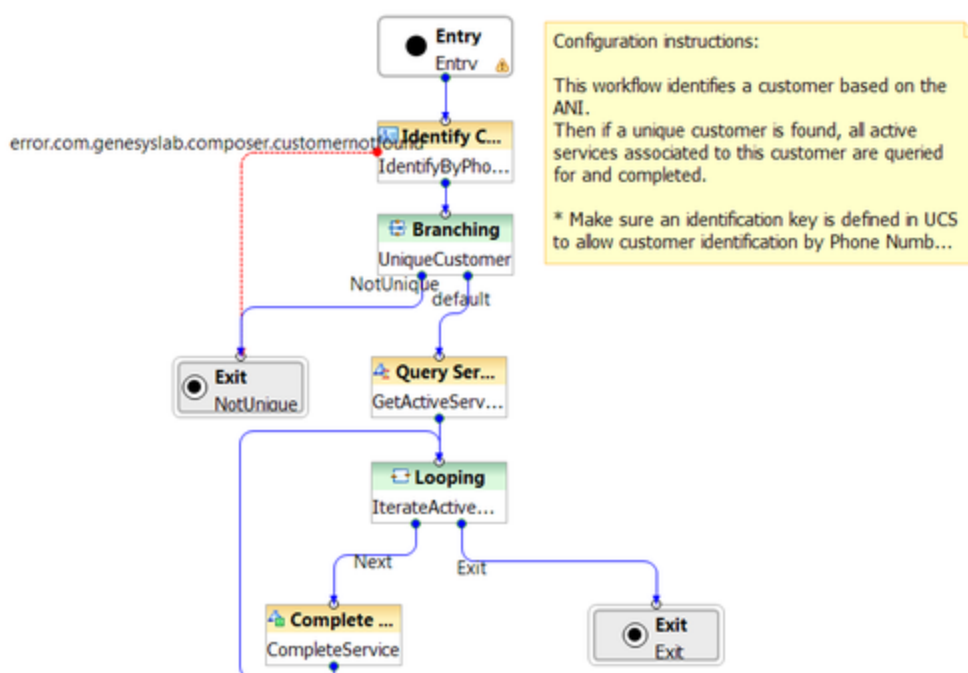

This workflow identifies a customer based on the ANI. If the customer is found, all active services associated to that customer are queried for and completed. **Pre-requisites:** The prerequisites are as follows:

- Set the ANI correctly since it is used to identify the customer.
- Define an identification key in Universal Contact Server to allow the customer to be identified by PhoneNumber.
- Set Context Services Preferences in Composer.

The workflow does the following:

1. Identifies the customer with the Identify Customer block:

- Identifies by setting the customer attributes to be used to search for the customer. Here, the phone number is matched to the inbound ANI.
 - Specifies the name of the key to be used for lookups (idPhoneNumber). This key must be defined in Universal Contact Server (UCS).
 - Gets the Customer Count and Customer Data information from UCS and assigns the information to variables.
2. Determines the uniqueness of the identified customer. Using the Branching block to check whether the number of customer records returned by Universal Contact Server is 1.
 3. Assigns the CustomerID to a variable using the Assign block. If the customer is unique, gets the CustomerID from the customer data retrieved from Universal Contact Server.
 4. Queries the active services for the customer using the Query Services block:
 - Sets the Service Identifier to the CustomerID.
 - Sets the Service Status to Active.
 - Stores the Service Data results in an application variable.
 5. Assigns the Service ID using the ECMAScript block. Retrieves the ServiceID from the Service Data.
 6. Determines if the retrieved service is active using the Branching block. Determines if the ServiceID is defined.
 7. Completes the active service using the Complete Service block

Resume Active Service Workflow

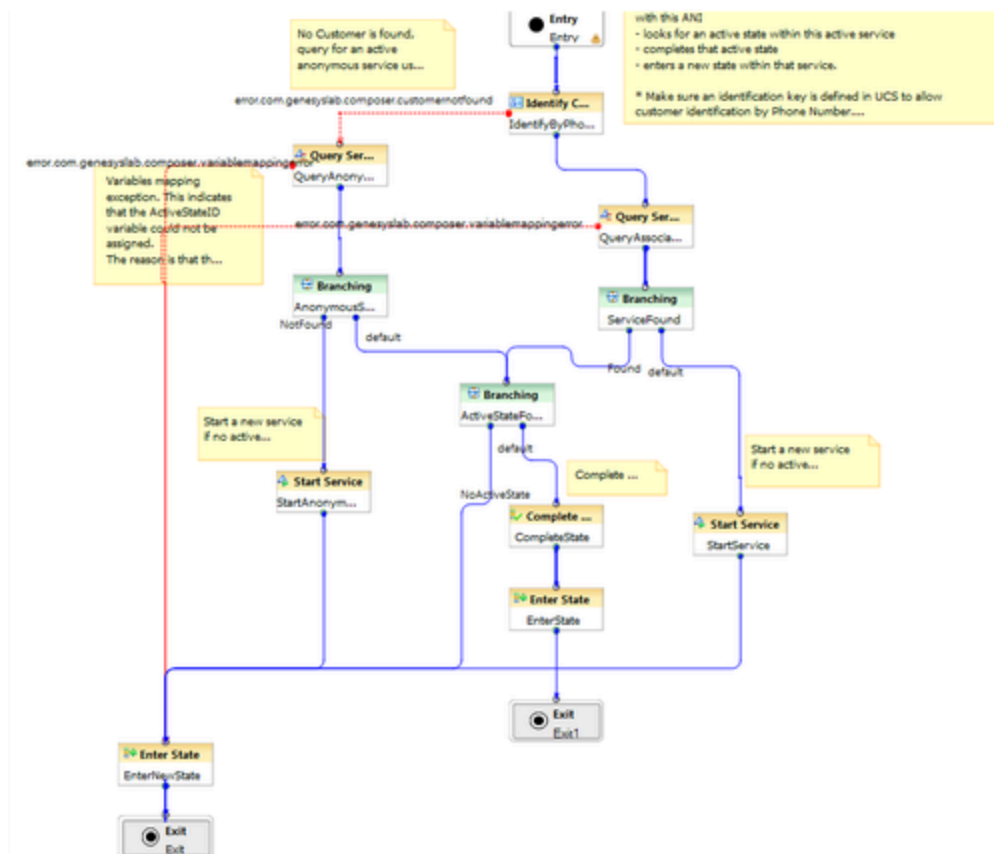

This workflow identifies a customer based on the ANI. If the customer is found, the active service associated to that customer is queried for and the active state within that active service is completed and a new state within the service is entered. **Pre-requisites:** The prerequisites are as follows:

- Set the ANI correctly since it is used to identify the customer.
- Define an identification key in Universal Contact Server to allow the customer to be identified by PhoneNumber.
- Set Context Services Preferences in Composer.

This workflow does the following:

1. On the right side, Identify Customer, ECMAScript, Query Services, and Branch blocks are similar to ones described above for the Complete Active Service workflow.
2. Continuing with the right side of the workflow, a new service is started with the Start Service block if an existing active service is not found. The Identifier is set to the customer ID previously retrieved in the Identify Customer Service block.
3. An ECMAScript block assigns the active service ID to a variable.
4. Using the ECMAScript block results, a Branching block determines if an active state exists for the service.

5. A Complete Services block sets the Service ID to complete the active service.
6. On the left side of the workflow, a Query Services block queries an anonymous service using the ANI as contact key if the customer is not found:
 - Set the ANI as the contact key in the Identifier property.
 - Set the Service Elements to Active States.
 - Store the Service Data in an application variable.
7. A Branching block determines if the service data retrieved from the Query Services block is defined.
8. A Start Service block starts a new service if no anonymous active service is found:
 - Set the Identifier to the ANI.
 - Store the Service ID in an application variable.
9. An Enter State block causes the service to enter a new state:
 - Set the Service ID.
 - Set the previous State ID.
 - Set the State Type property to filter for the specific Service State type.

Update Profile Workflow

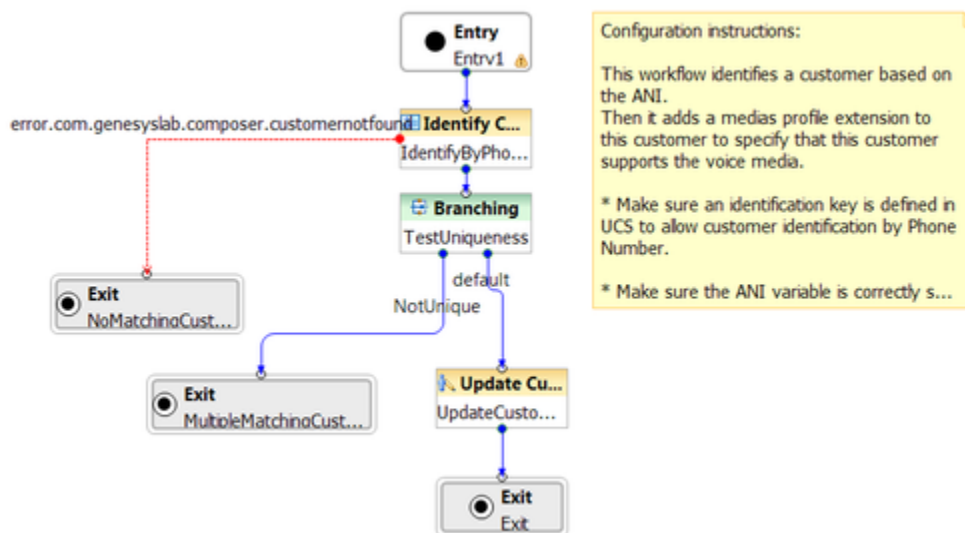

This workflow identifies a customer based on the ANI. If the customer is found, the contact setting of the customer profile is updated by setting the medias/voice extension attribute value to true. **Prerequisites:** The prerequisites are as follows:

- Set the ANI correctly since it is used to identify the customer.
- Define an identification key in Universal Contact Server to allow the customer to be identified by

PhoneNumber.

- Define the medias customer profile extension in Universal Contact Server and that extension should have the Boolean attribute voice defined.
- Configure Context Services Preferences in Composer.

This workflow does the following:

1. The first two blocks Blocks are described in the previous Complete Active Services workflow.
2. An Assign block saves the CustomerID and customer data information:
 - Retrieve and assign the CustomerData to an application variable
 - Retrieve and assign the CustomerID to an application variable
3. An Update Customer block updates the customer profile:
 - Specify the extension customer profile data. Select the medias extension and set the voice attribute to true.
 - Set the CustomerID.
 - Select the Insert Extension operation to insert the extension record.

Database Query Result Template

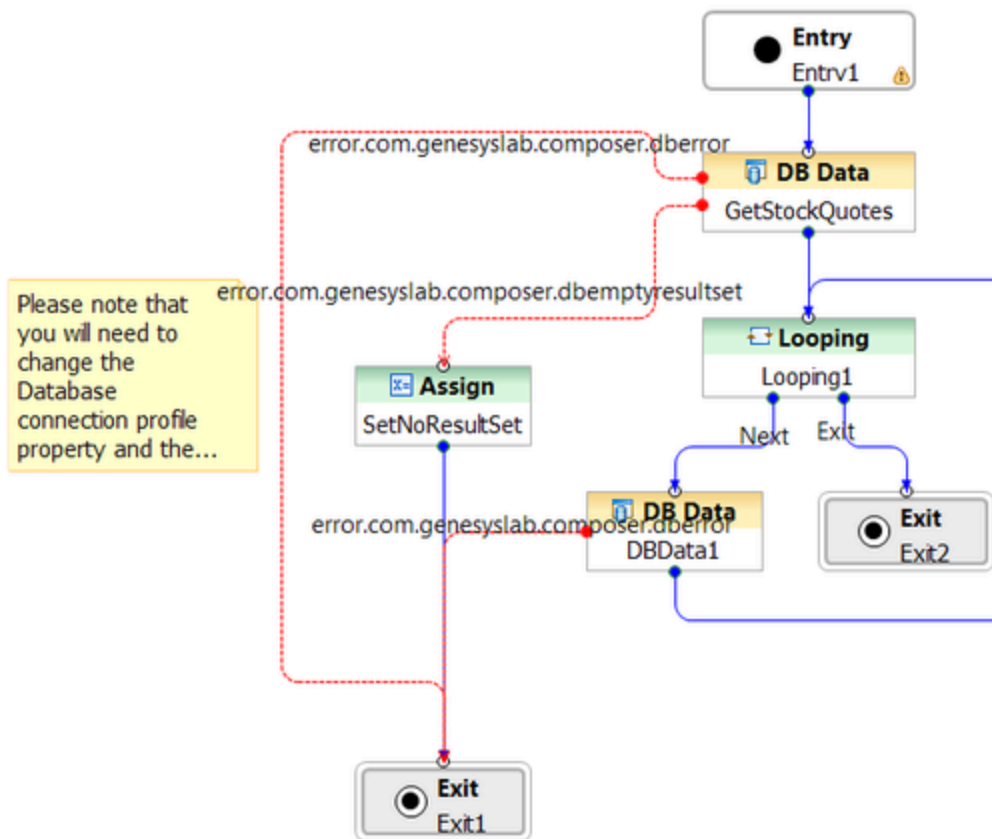

>br>

This template demonstrates how to access the results of a database query in a workflow.

1. First, the application makes a query in the GetStockQuotes DB Data block. The query is defined using the Query Builder interface. The results of the query are saved to variables call DBColumnNames and DBRecords, which are defined in the Entry block. They are assigned using the Database Result Set properties of the DBData block.
2. Next, the FetchFirstRecord ECMAScript block uses a script to access the data. The DBRecords variable is a two-dimensional array containing the rows and columns of the returned data. The script in the FetchFirstRecord block extracts and assigns the first row of to a variable called DBCurrentRecord.
3. The SaveToVariables Assign block assigns the columns of the row in DBCurrentRecord into separate variables.
4. The next DB Data block, DBData1, uses the variables assigned in the previous step to make a stored procedure query to the database. The stored procedure is defined with the Stored Procedure builder interface, which is similar to the Query Builder.
5. The FetchNextRecord ECMAScript block runs a script to load the next row from the DBRecords variable obtained by the first query.
6. The CheckMoreRecord Branching block checks if there are any more records (rows) in the result set and will loop back if there are in order to process the next row and repeat the stored procedure query in

DBData1. Once there are no more records to process, the workflow exits.

Forward to External Resource Template

This template demonstrates screening a customer e-mail to see if it describes a known problem so that a standard (automatic) response can be sent to the customer. If the e-mail does not describe a known problem, then an acknowledgement e-mail is sent to the customer and the customer's e-mail is forwarded to an external resource (such as an expert or knowledge worker) for a reply. When the reply is received from the external resource, the reply is forwarded to the customer. The template is shown below.

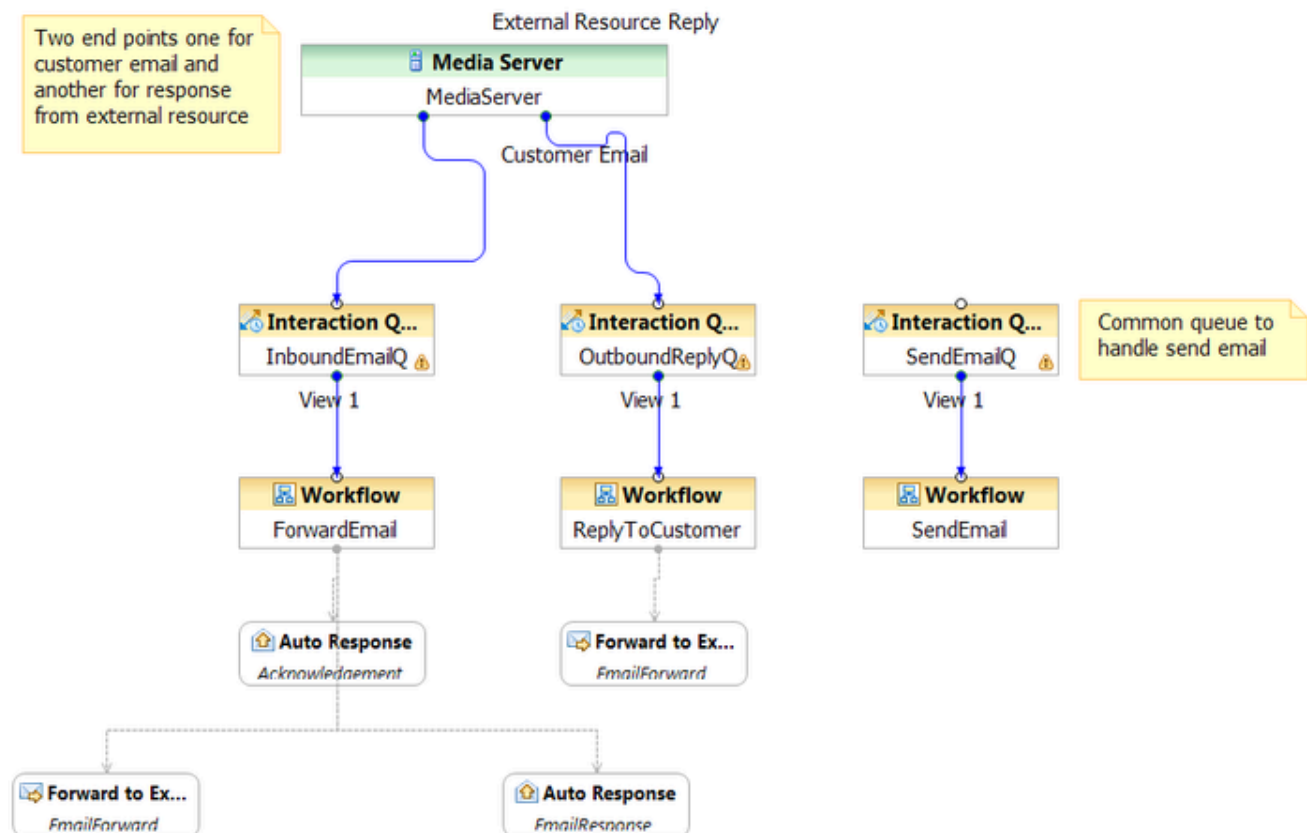

1. The **interaction process diagram** (IPD) starts with a Media Server block, which defines Customer E-mail and External Resource Reply **endpoints**. Defining two endpoints allows e-mails arriving from customers and external resources to get into the appropriate **interaction queues**.
2. In the first column of blocks in the IPD, the InboundEmailQ queue sends e-mails to a Workflow block, which points to the CreateForwardEmail.workflow. The workflow first screens the incoming customer e-mail using a **Screen Interaction block**.
 - If a screening rule match is found, an e-mail response is sent to the customer. This is achieved by using an **E-mail Response block** with the Response Type property set to Autoreponse. The Output Queue property is set to SendEmailQ, which allows the newly

created e-mail to be queued and processed by `SendCreatedEmail.workflow`.

Note: The `SendEmailQ` queue is used by all the e-mails created in this sample (even though it is not explicitly stated in order to avoid duplication). In cases where the `Output Queue` property is not specified, the system interaction queue is used and the e-mail is automatically sent out by `Orchestration Server`. Though this latter approach does not allow for any further processing before the e-mail is sent out, it is a satisfactory approach for many scenarios.

- If a screening rule match is not found, the workflow sends an acknowledgement to the customer and the customer e-mail is forwarded to the external resource.
3. An `E-mail Response` block is used for the acknowledgement e-mail with the `Response Type` property set to `Acknowledgement`.
 4. An `E-mail Forward` block is used to forward the e-mail to the external resource with `Forward Type` set to `Forward`. At this point, the external resource is expected to respond back with a reply to the forwarded e-mail.
 5. The second column of blocks in the IPD is used for processing the reply from the external resource. The `External Resource Reply` endpoint directs the reply from the external resource into the `OutboundReplyQ` queue. This queue then directs the reply into the `ReplyToCustomer Workflow` block, which points to the `CreateReplyToCustomerEmail.workflow`. This workflow uses the `Email Forward` block with `Forward Type` set to `ReplyToCustomer` with a `Standard Response` to format the customer reply. It also defines the `To` address (`Originating Email -- From`) specifying that the e-mail is to be sent to the same address from which the incoming customer e-mail originated. The reply e-mail then goes to the `SendEmailQ` queue.
 6. The third column of blocks in the IPD is used for sending the reply e-mail to the customer. The `SendEmailQ` queue is connected to the `SendEmail Workflow` block, which points to the `SendCreatedEmail.workflow`. This workflow contains a **Send E-mail block** used for sending the external resource reply to the customer.

Route After Autoresponse Template

This template demonstrates using the Create E-mail block to send an e-mail auto-response to an incoming e-mail and then using the Route Interaction block routes the e-mail to an agent.

- When an e-mail (new multimedia interaction) arrives at the Media Server Endpoint1, it gets queued to IncomingEmailQueue. The IPD is shown below.

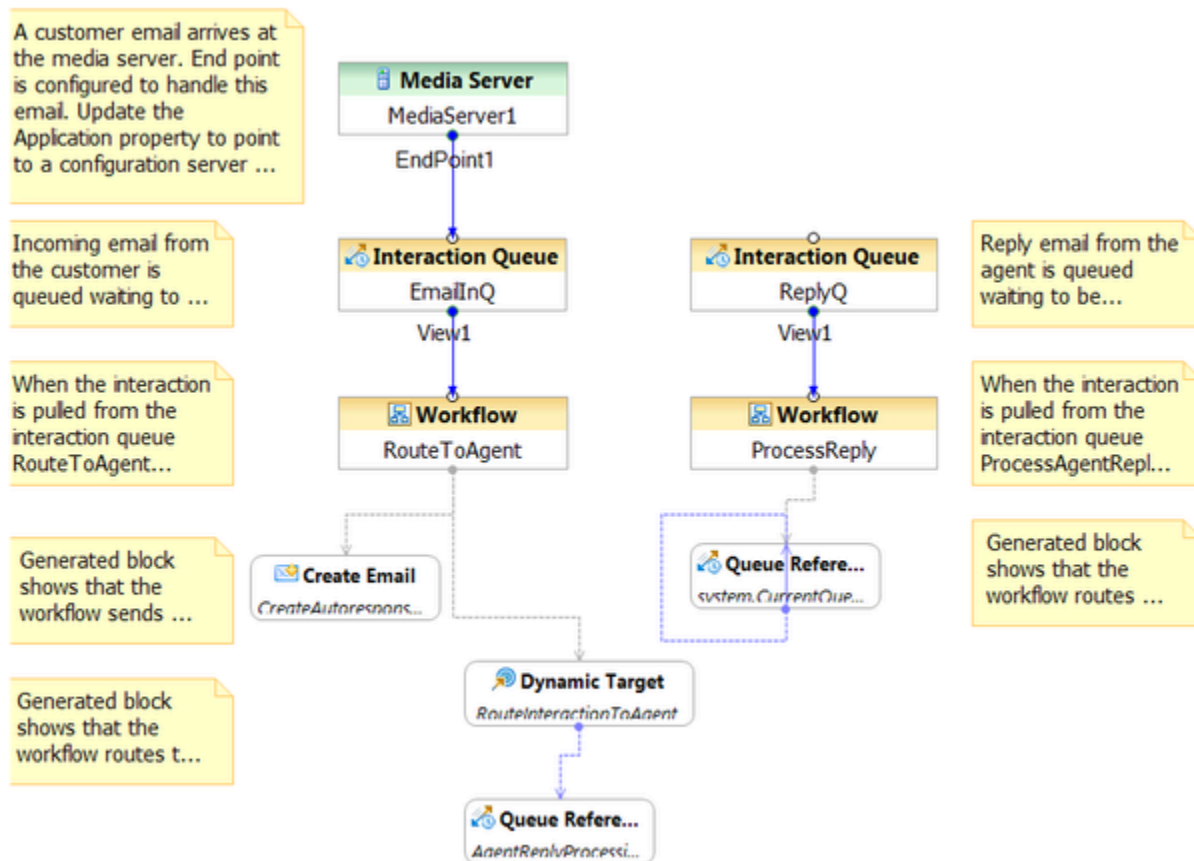

- Orchestration Server then pulls the interaction from the queue and starts processing the RouteToAgent workflow shown below.

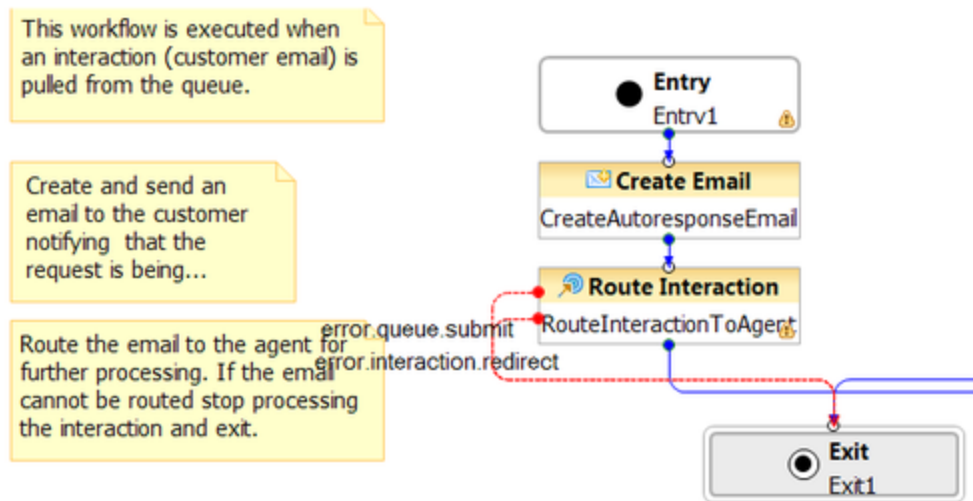

1. The RouteToAgent workflow uses the Create E-mail block to first send out an auto-response e-mail to the customer notifying that the system has received their e-mail and someone be contacting them shortly. After sending the auto-response e-mail, the original e-mail from the customer is then routed to an agent for a response.
2. The workflow then uses the Route Interaction block to route to a target.
3. The Route Interaction block also specifies a suggested queue for the new interaction (agent's response e-mail).
4. After the agent responds (using reply feature in Genesys Agent Desktop), the response is now treated as a new interaction is then placed into the suggested queue.
5. The agent then closes the current interaction (using Done feature in Genesys Agent Desktop).
6. When Orchestration Server pulls the new interaction from AgentReplyProcessing queue, the ProcessAgentReply workflow gets executed.

This workflow is executed when a new interaction (agent's reply to a customer email) is pulled from the queue.

Route the new interaction (agent reply email) to the Supervisor for verification. After the Supervisor approves or edits the email it is processed by another queue not included in this template.

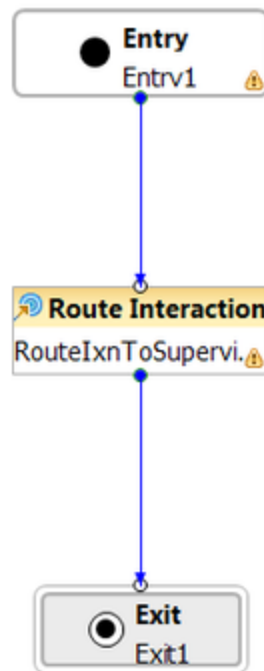

1. ProcessAgentReply is a simple workflow which routes the agent response e-mail to a supervisor for review.
2. Once the supervisor is satisfied with the response, the email is placed in the system queue and sent out to the customer.

At this point, there are no further interactions that need to be processed and the application (session) exits.

Routing Based on Variables Template

This template demonstrates how to route calls to DNS dynamically using variables and force routing.

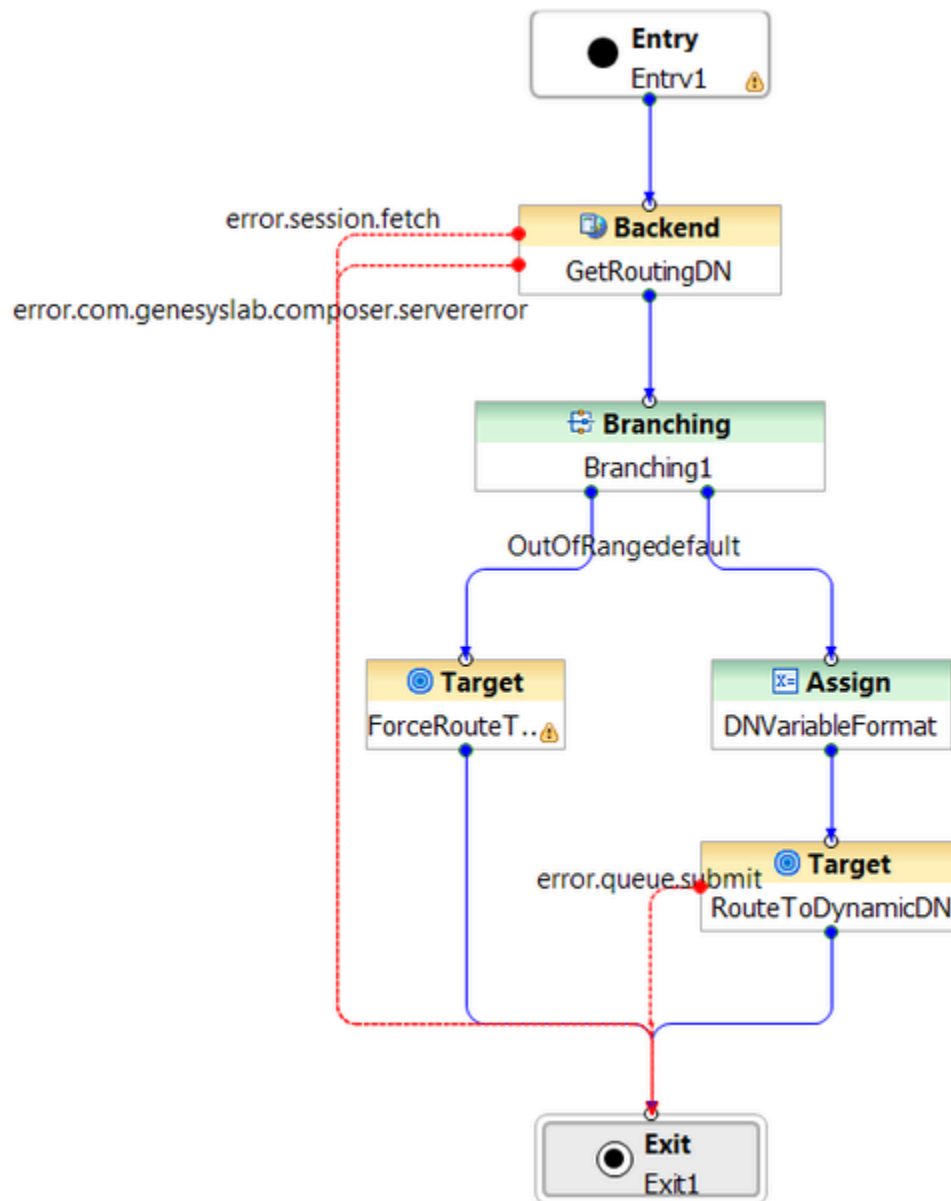

1. In the GetRoutingDN Backend block the application accesses some backend business routing logic defined in the file `../include/SomeRoutingLogic.jsp`. This business logic will pass back a DN to route to in the `varRoutingDNFromLogic` variable.

2. Depending of the DN set in the varRoutingDNFromLogic variable, the Branching block will conditionally route to the appropriate targets.
3. In the case where the variable varRoutingDNFromLogic is above 3010, the flow will be forced to route to RoutePoint 3000 as shown in the ForceRouteToDN Target block. After this is done the workflow will exit.
4. In the case where the variable varRoutingDNFromLogic is not above 3010, the DN will first be formatted in the DNVariableFormat Assign block and then be routed by the RouteToDynamicDN Target block. After this is done the workflow will exit.

Routing Based on Date and Time Sample

This application demonstrates routing based on business hours. A customer care company separates customer calls based on working days (Monday - Friday) and working hours (09:00 -17:00). Based on the working days and hours, the company sends the customer call to one of two targets.

- Agent Group #1: CustomerServiceTeam - Available during the working days and hours.
- Agent Group #2: AfterHoursTeam - Available for non-regular working days and hours.

Previous Genesys Administrator (or Configuration Manager) setup involved defining Agent Groups and agents (Persons). The workflow diagram is shown below.

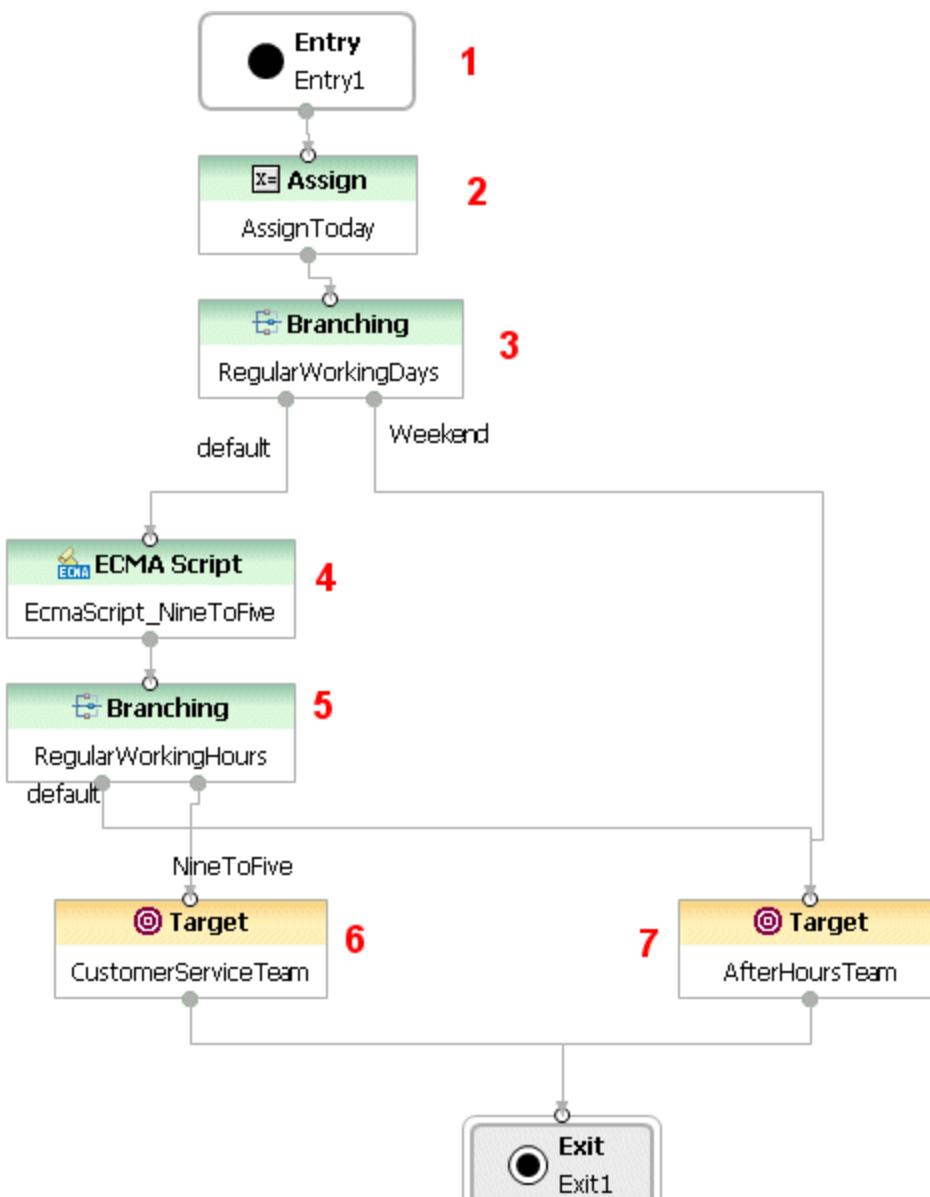

The above diagram is keyed to the numbers below.

1. The Entry block Variables property includes three user-defined variables. The Today and IsNineToFive variables are used for this application.
2. The Assign block Assign Data property assign a value to the Today variable. The function shown returns the current day of the week in the specified timezone.

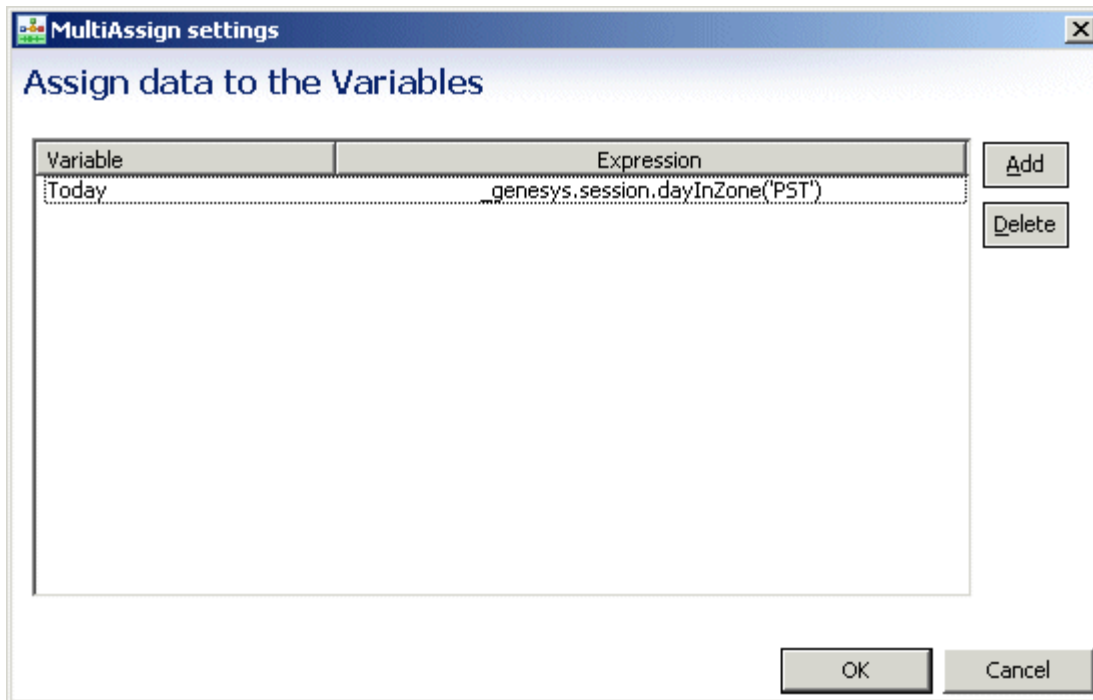

3. The Branching block Conditions property contains an expression used for segmenting interactions based on the date condition.

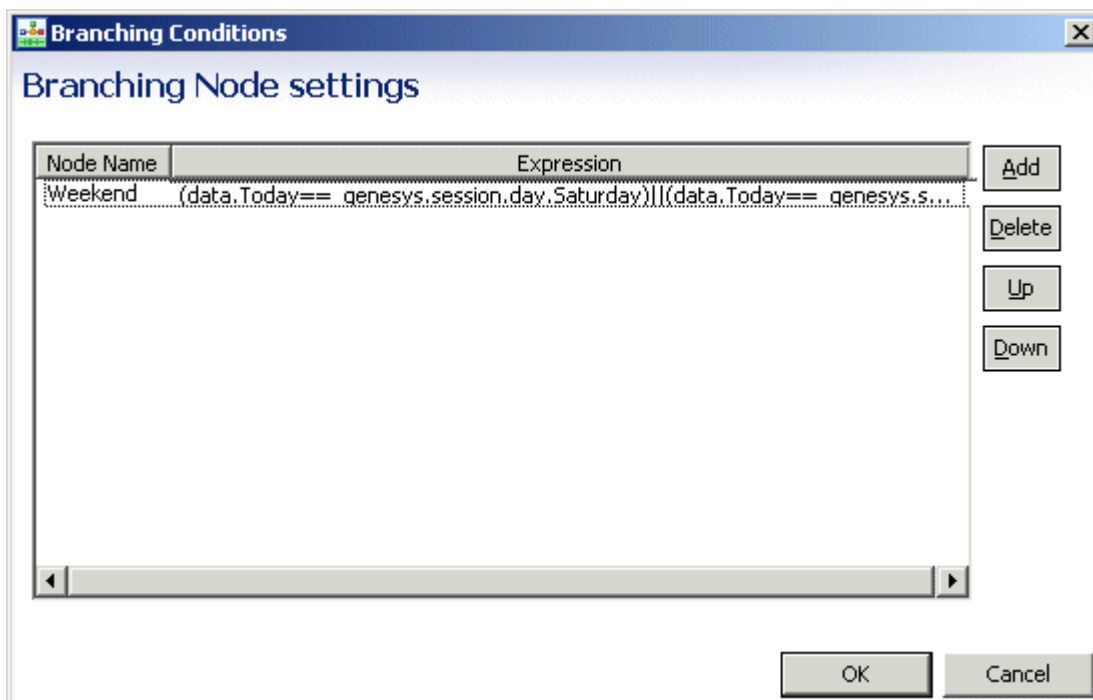

4. You can open [Expression Builder](#) from the [Condition](#) property of the branching block and access Orchestration Server date/time functions (Data Category=Orchestration Server Functions > Data Subcategory=genesys):

5. The ECMAScript block Script property uses standard ECMAScript time objects.

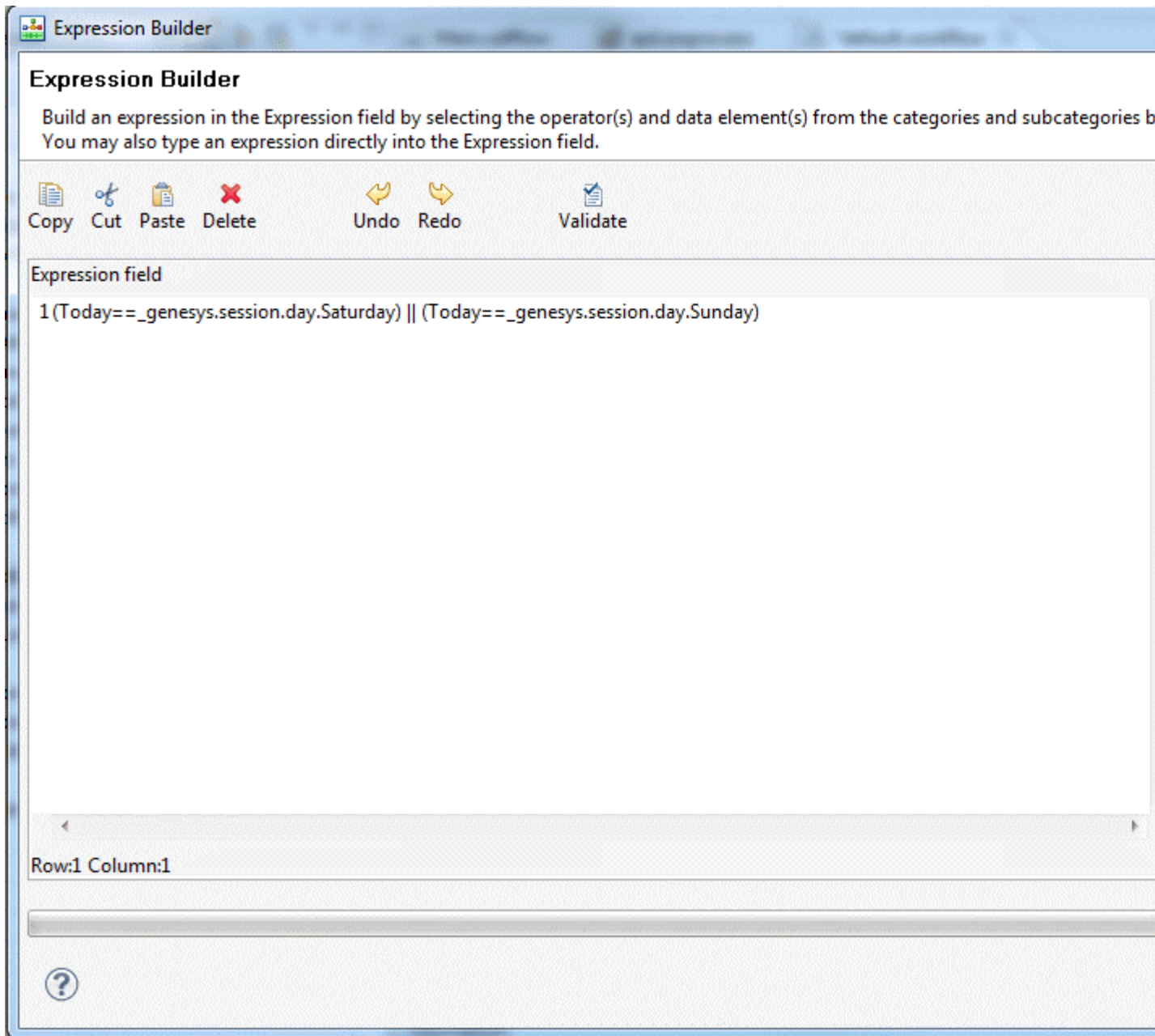

6. The Branching block Conditions property contains an expression, which determines whether the interaction goes to the CustomerServiceTeam or the AfterHoursTeam Agent Group.
7. The first Target block routes to the CustomerServerTeam.
8. The second Target block routes to the AfterHoursTeam.

Routing Based on a Statistic Sample

This template demonstrates routing based on the value of a statistic. For a definition of each statistic and recommended usage, consult the chapter on routing statistics in the [Universal Routing 8.1 Reference Manual](#). For technical background on statistics, see the [Real-Time Metrics Engine](#) documentation. The statistic you select in the Target block [Statistics Property](#) is used by Universal Routing Server to determine which target to route the interaction to if more than one target is available. After defining a complete set of available agents (taking agent capacity rules into consideration, if configured), URS applies the selection criteria specified in the Target block, which can include using the minimum or maximum value of the statistic (see [Statistics Order](#) property). The workflow diagram is shown below.



The Target block Properties view is shown below.

Property	Value
Alias	
Name	Target1
Exceptions	
Exceptions	
Misc	
Clear Targets	<input checked="" type="checkbox"/> true
Statistic	StatAgentOccupancy
Statistics Order	Min
Targets	AgentGroup 11110, AgentGroup 11113, AgentGroup 11111, AgentGroup 11112
Timeout	
Treatments	
Use Treatments	<input checked="" type="checkbox"/> false
Use Virtual Queue	<input checked="" type="checkbox"/> false
Virtual Queue	

The Misc properties that were configured are described below.

Clear Targets

When this property is set to true, URS retains the targets listed in the block are after the interaction moves on through the strategy and encounters other Target blocks (not present in this simple sample). For more information on this property, see the [Target Block Clear Targets Property](#). The selected statistic is StatAgentOccupancy. This statistic enables URS to route interactions to the least occupied agent, which is the agent with the lowest occupancy rate. Occupancy rate is the ratio between the time the agent has been busy since last login relative to the agent's total login time. StatAgentOccupancy enables URS to evaluate multiple available agents and select the least occupied agent so that the workload among available agents is balanced.

Statistics Order

This property can work with the Statistics property. **Min** was selected indicating the interaction should be routed to the target with the minimum value of the StatAgentOccupancy statistic. For more information on this property, see the [Target Block Statistics Order Property](#).

Targets

The figure below shows the entries in the Targets dialog box.

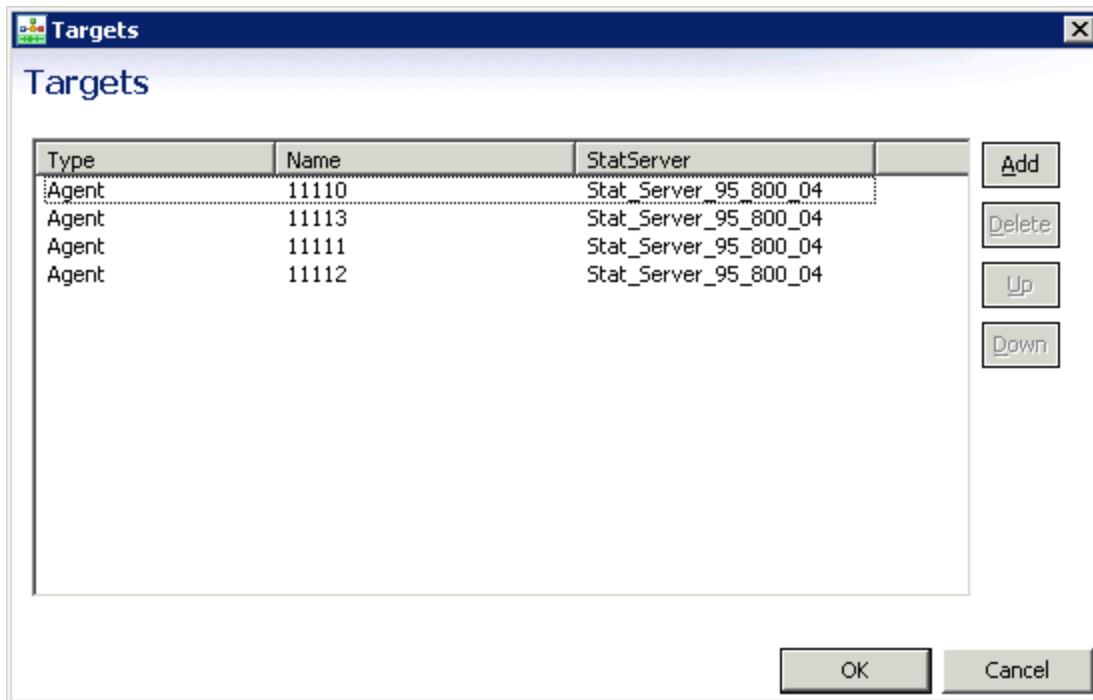

Using the StatAgentOccupancy statistic URS will select the least occupied agent among these based upon information from the specified Stat Server.

Timeout

While not used in this sample, this property allows you to specify the time in seconds an interaction waits for an available target. If the timeout expires before one of the targets is available, the interaction is routed to the error port. For more information on this property, see the [Target Block Timeout Property](#). The remaining properties are left at their default values.

Routing Based on Percent Allocation

This application demonstrates distributing interactions to targets based on a set percentage for each target. The workflow diagram is shown below.

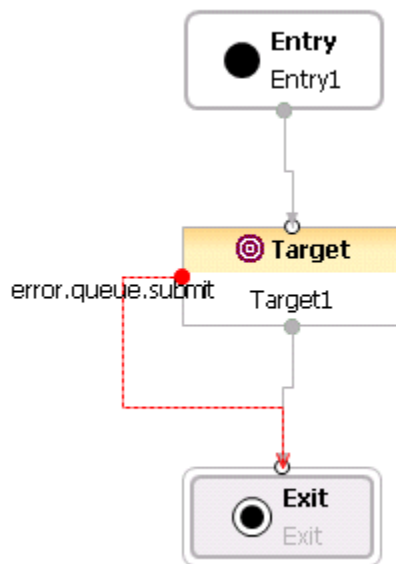

The Entry block does not contain any user-defined **variables**. The Target block Properties view is shown below.

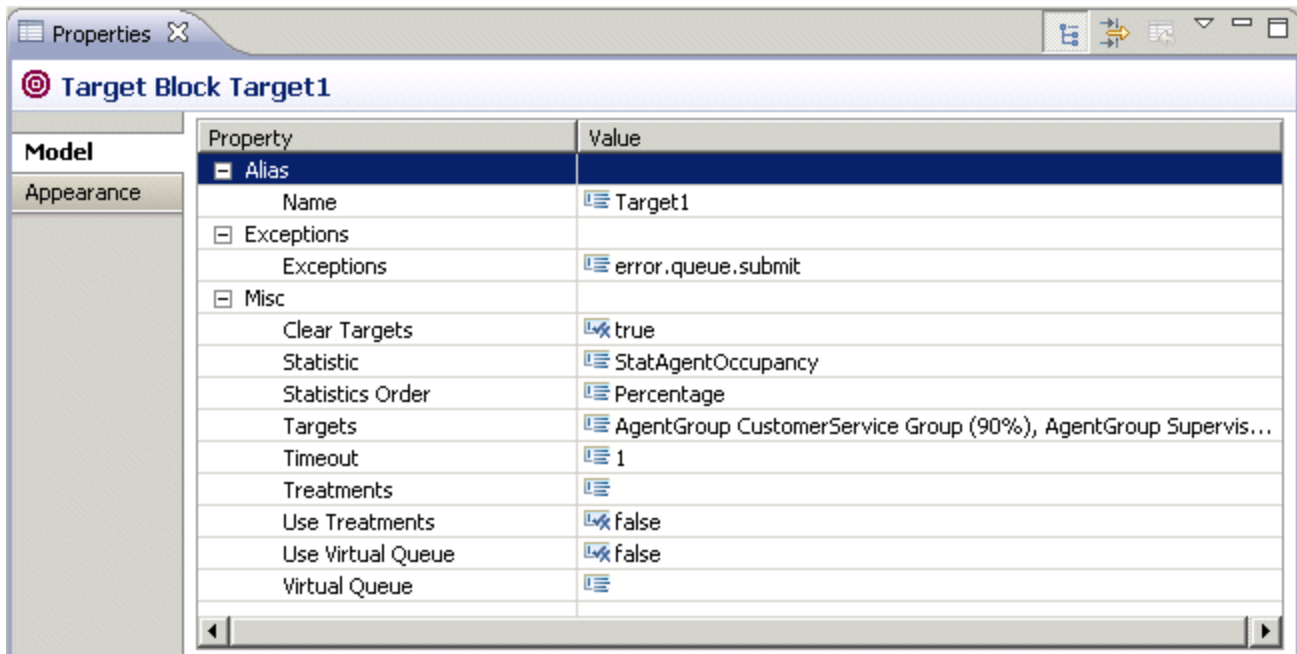

The Misc properties that were configured are described below.

Clear Targets

When this property is set to true, URS retains the targets listed in the block after the interaction moves on through the strategy and encounters other Target blocks (not present in this simple sample). For more information on this property, see the [Target Block Clear Targets Property](#).

Statistic

The selected statistic is StatAgentOccupancy. This statistic enables URS to route interactions to the least occupied agent, which is the agent with the lowest occupancy rate. Occupancy rate is the ratio between the time the agent has been busy since last login relative to the agent's total login time. StatAgentOccupancy enables URS to evaluate multiple available agents and select the least occupied agent so that the workload among available agents is balanced. For more information on this property, click [Target Block Statistics Property](#).

Statistics Order

Percentage is selected in order to route interactions to targets based on a percentage allocation. Selecting Percentage causes the dialog box that opens from the Targets property to display a Weight column where you can specify a percentage for each target. For more information on this property, see the [Target Block Statistics Order Property](#).

Targets

The figure below shows the entries in the Targets dialog box.

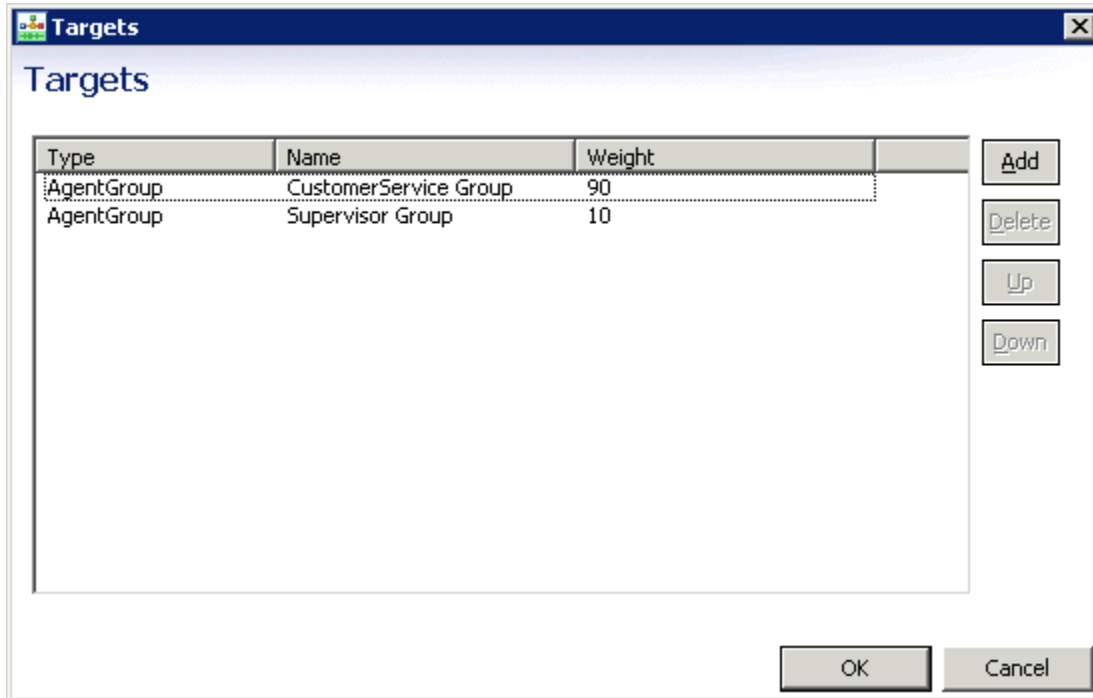

URS will route 90% of the calls to the CustomerService Group and 10% of the calls to the Supervisor Group. Using the StatAgentOccupancy statistic URS will select the least occupied agent among these based upon information from the specified Stat Server.

Timeout

This property allows you to specify the time in seconds an interaction waits for an available target. If the timeout expires before one of the targets is available, the interaction is routed to the error port. For more information on this property, click [Target Block Timeout Property](#). The remaining properties are left at their default values.

Routing Using Web Request Sample

This application demonstrates using the Web Request block to invoke an HTTP web request. The workflow diagram is shown below.

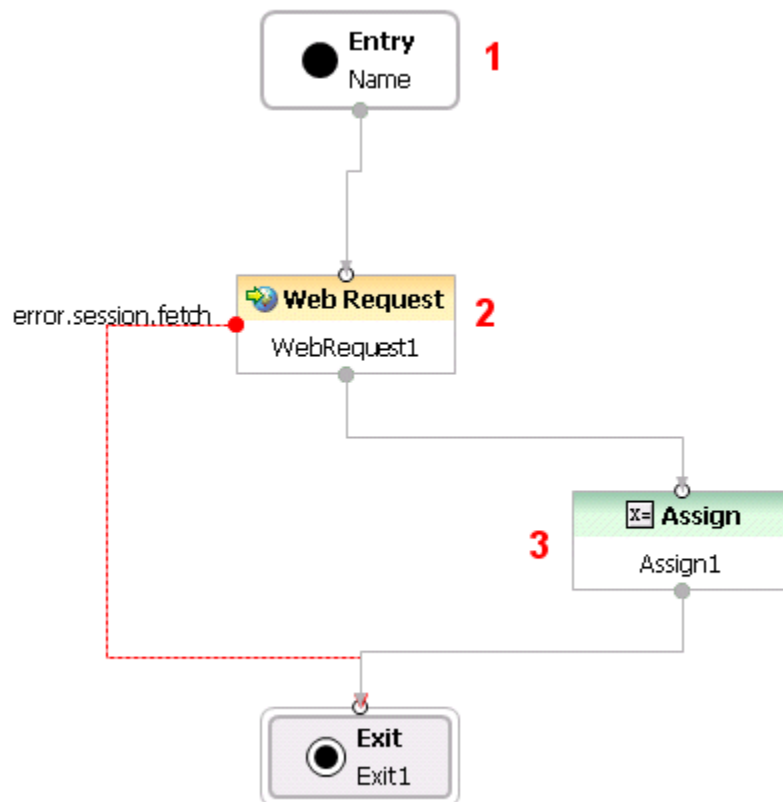

The above diagram is keyed to the numbers below. The Entry block Variable Settings dialog box is shown below.

Variable Settings			
Application Variables			
Variable Name	Type	Value	Description
App_Language	System	en-US	Application Language
CallID	System	_genesys.ixn.interactions[0].voice.callid	callid created by the switch.
DNIS	System	_genesys.ixn.interactions[0].voice.dnis	DNIS associated with Call...
ANI	System	_genesys.ixn.interactions[0].voice.ani	ANI associated with the c...
App_Last_Error	System	undefined	Last error
App_Last_Error_Description	System	undefined	Last error description
weblink	User	http://138.120.84.95:8080/JavaComposerP...	Enter Description
webresult	User	Enter Value	Enter Description
assignresult	User	Enter Value	Enter Description

Three user-defined variables are defined:

- `weblink`: Points to the `getMemoryStatus.jsp` application from the `src` directory. This represents an application hosted on an external application server.
- `webresult`: Holds the result of the get request.
- `assignresult`: The content of the `webresult` variable is transferred to this variable in the Assign block.

The Web Request block Properties view is shown below.

Property	Value
Alias	
Name	WebRequest1
Exceptions	
Exceptions	error.session.fetch
Location	
Request Method	get
Uri	variable(weblink)
Parameters	
Input Parameters	
Security	
Authentication Type	anonymous
Login Name	
Password	
Web Request Result	
Result	variable(webresult)

- The Exceptions property indicates support for the `error.session.fetch` event.
- The Request Method property has two choices: `get` or `post` with `get` selected indicating the type of request (HTTP Get) that Universal Routing Server will make.
- The Uri property indicates that the Uri is contained in a variable called `weblink`.
- The Authentication Type property has two choices: `anonymous` or `basic` with `anonymous` selected as a security setting. With this type of access, no user name/password is passed to the Web service for client authentication in order to get data.

- The Result property indicates that the data from the get request will initially be stored in a variable called webresult.

The Assign block properties view is shown below.

Property	Value
Alias	
Name	Assign1
Misc	
Assign Data	assignresult=data.webresult

The data received from the get request is assigned to a variable called assignresult.

Last Called Agent Routing

This topic summarizes how to use Composer to create a routing strategy that gives the calling customer the option to speak to the agent who handled their previous call or to wait for a callback from that agent.

Last Called Agent (LCA) Routing

You can use Composer to create an **Integrated Voice and Route** application that routes a customer call to the agent who last spoke with that customer (last called agent or LCA routing). The sample below summarizes one way to configure LCA routing. In this sample, an **Interaction Workspace** custom **extension** retrieves the last called agent information from the **Universal Contact Server (UCS) Database**.

Note: You can set the Contact Server Interaction Workspace option **contact.last-called-agent.enable** to save the last called agent ID to the Universal Contact Server database. To use the agent ID in a routing workflow, you can use **Expression Builder** to create a custom **extension** (such as that shown in the sample below) that retrieves the agent ID from the UCS Database. Interaction Workspace installed "out-of-the-box" does not supply the extension used in the sample below.

Scenario Summary

- A customer calls the contact center and the call is routed to an agent.
- The agent ID and the call time is saved to the customer contact information in the UCS database. As a result, a future call from the customer can be routed to the same agent.
- If the customer calls again and requests the last called agent, the call is routed to that agent. If that agent is unavailable, the **voice treatment** offers three options: Request a callback, Wait, or Leave a voicemail.

Interaction Process Diagram

All Composer routing applications start with an **interaction process diagram (IPD)**. For a routing application used for voice only interactions, an IPD **Workflow block** points to a workflow resource (diagram). In the Workflow block shown in the figure below, the resource is the `LastAgentAndVoiceMail.workflow` diagram.

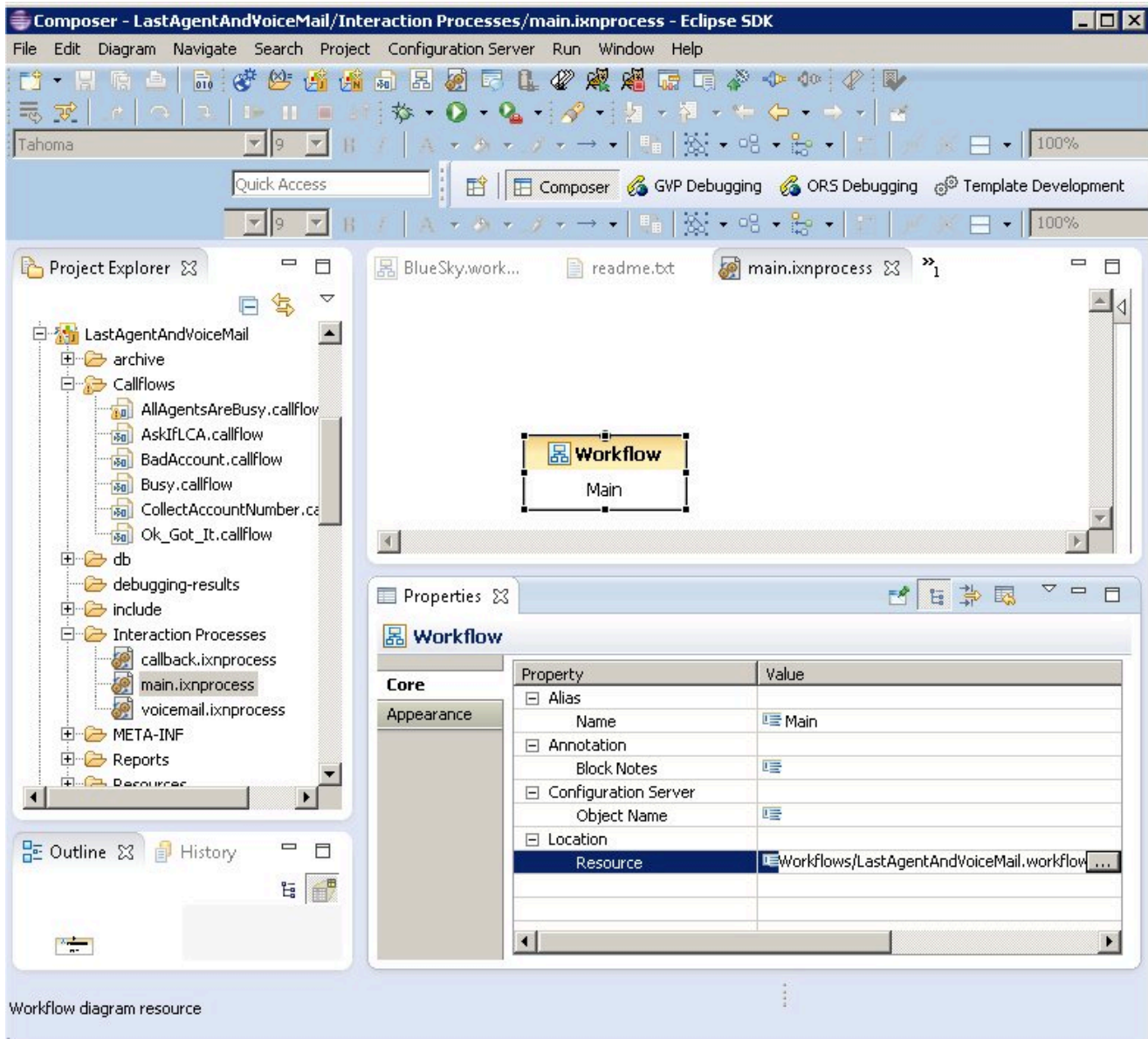

LastAgentAndVoiceMail.workflow

The sample workflow diagram that demonstrates LCA routing is shown below.

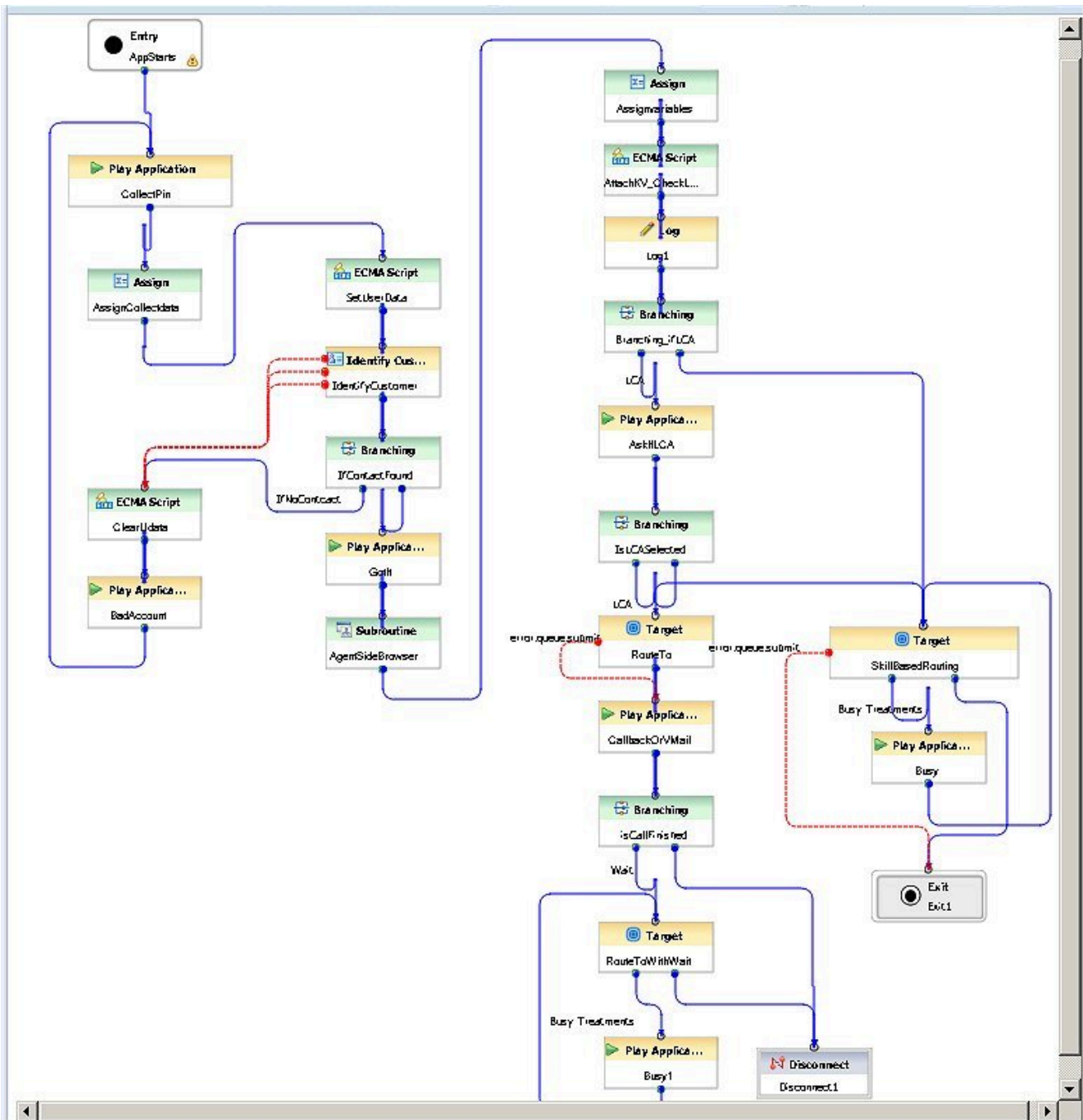

Each **block** in the workflow diagram is labeled with text that summarizes its function. This text appears below the block name. The next section discusses key blocks in the diagram.

Play Application Blocks

The above workflow diagram contain various **Play Application blocks**. These are numbered in the figure below.

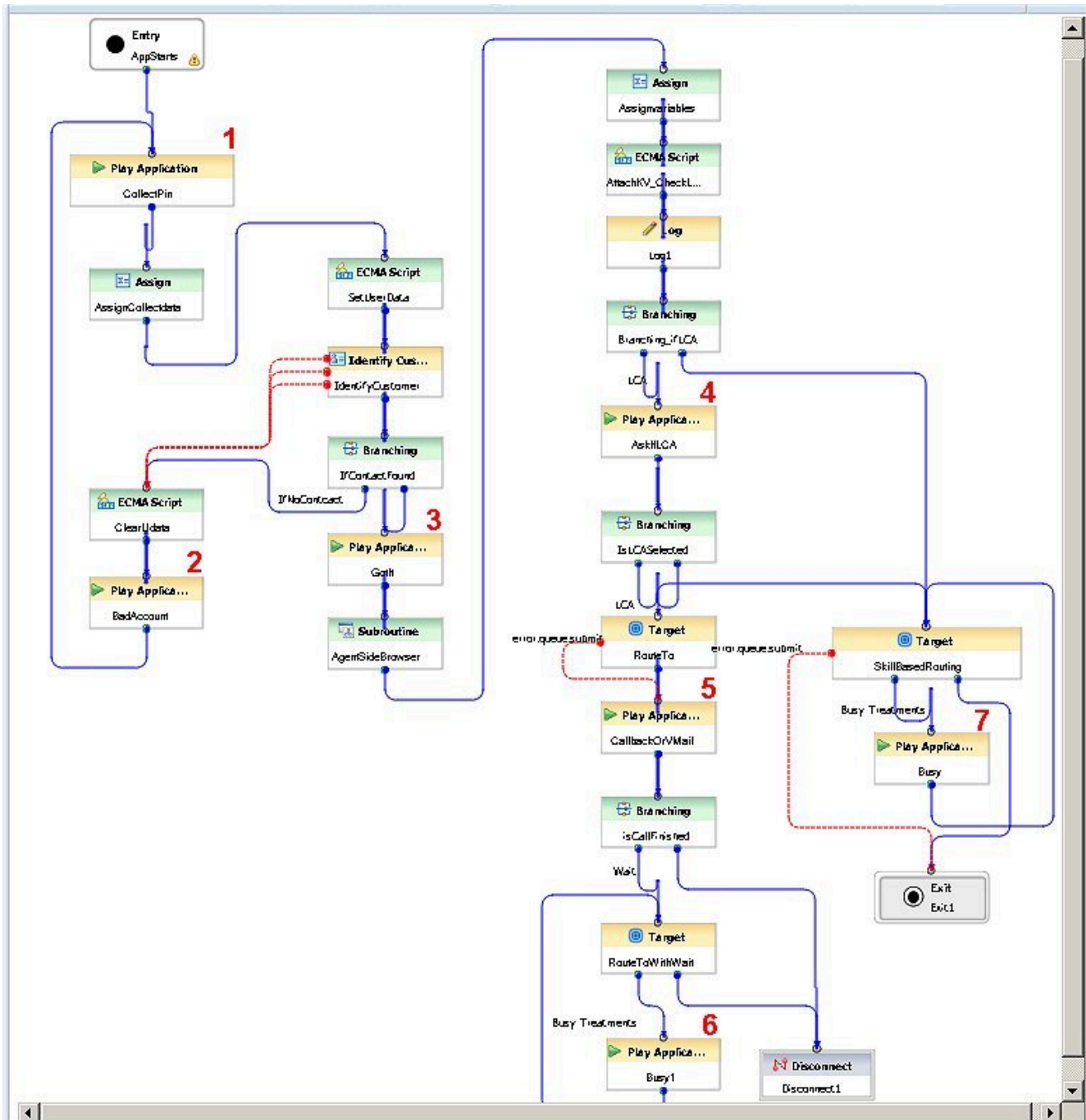

Reviewing the various voice prompts associated with these Play Application blocks helps you understand the flow.

last_agent_001.vox	Welcome. Please enter your four digit account number
last_agent_002.vox	Ok, got it.
last_agent_003.vox	Please hold while I transfer your call to an agent
last_agent_004.vox	Sorry, all of our agents are currently busy. Please hold for the
next available agent.	
last_agent_005.vox	Would you like to be connected to the agent that you spoke with
previously?	
	For yes, press 1. For no, press 2.
last_agent_006.vox	Ok, checking agent availability
last_agent_007.vox	Sorry, your agent is not available at the moment. To have the
agent call you back,	
	press 1. To leave a voicemail for the agent, press 2.
	Or just wait on the line for the agent.
last_agent_008.vox	Thank you, your callback request has been registered. The agent
will call you	
	back soon. Goodbye.
last_agent_009.vox	Ok, to leave a voicemail for the agent, being speaking at the
tone.	
	When you are finished, you can simply hang up or press pound.
last_agent_010.vox	Your voicemail has been recorded and will be delivered to the
agent.	
	Thank you for calling, goodbye.
last_agent_011.vox	Sorry, I didn't get that.

Blocks Used for LCA

This section summarizes the important blocks used for LCA routing in this particular sample. The figure below numbers the LCA-related block with the numbers keyed to descriptions further ahead.

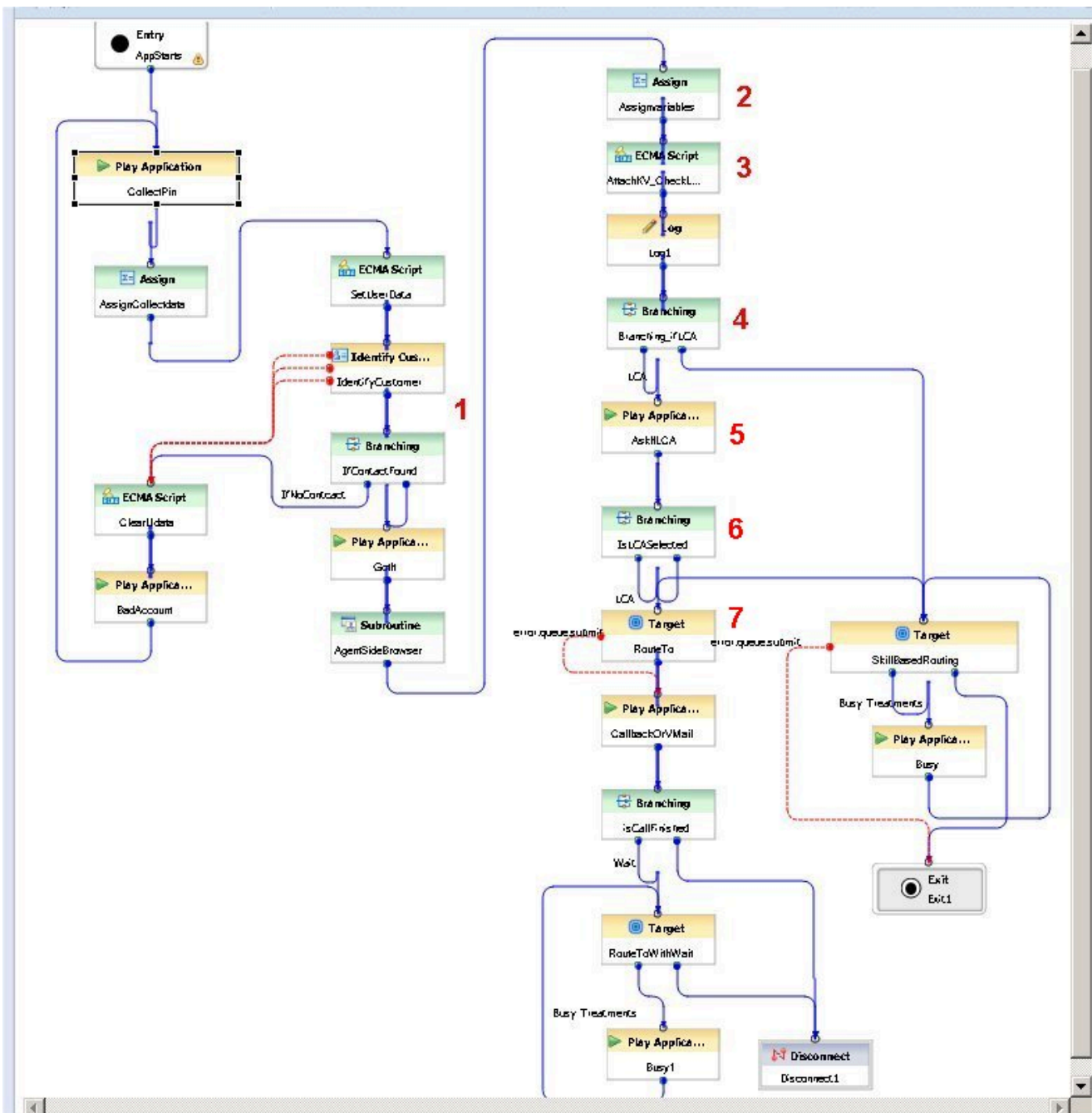

1. The **Identify Customer block (1)** uses the account number entered by the customer to search for contact information in the Universal Contact Server Database. A **Branching block (1)** causes the workflow to take different paths based on whether customer data is or is not found.
2. If found, an **Assign block (2)** assigns LCA information to variables.

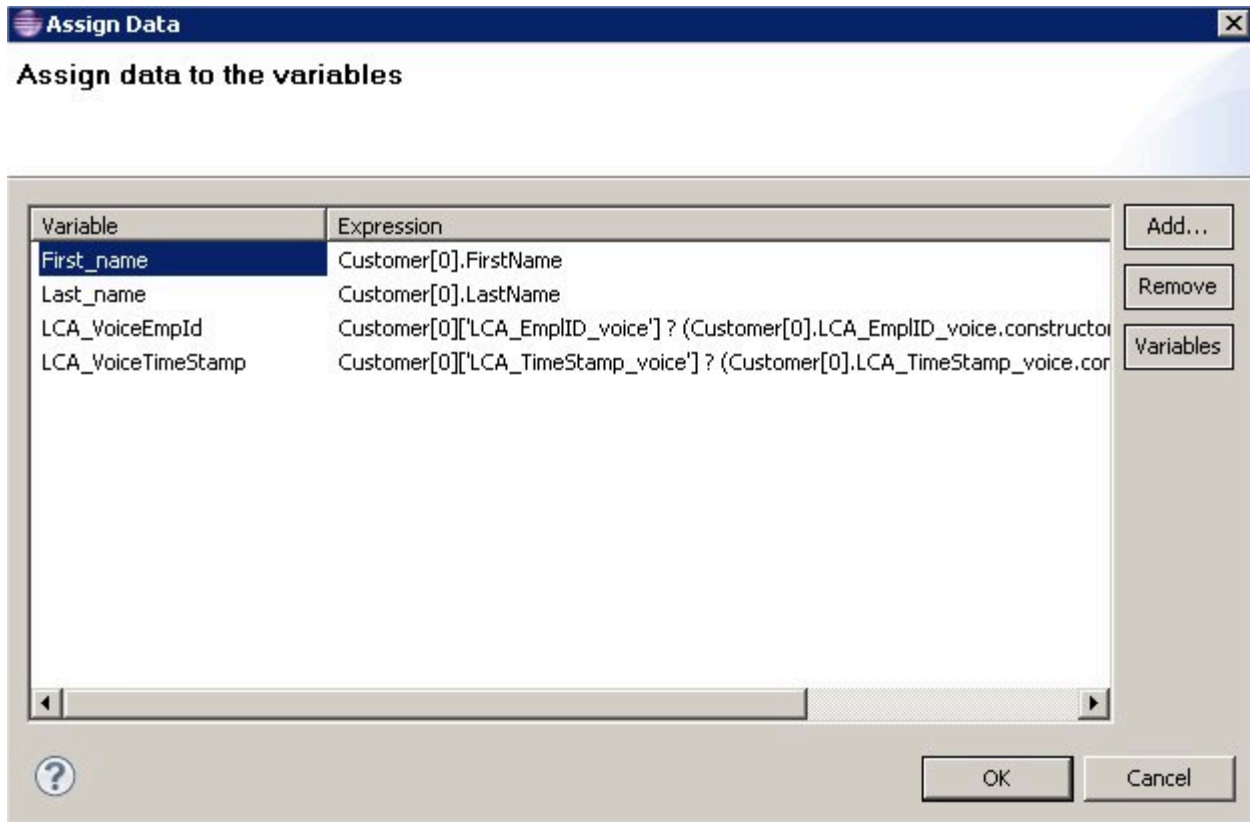

3. The **ECMAScript block (3)** calls a script created in **Expression Builder** to get the last called agent ID.

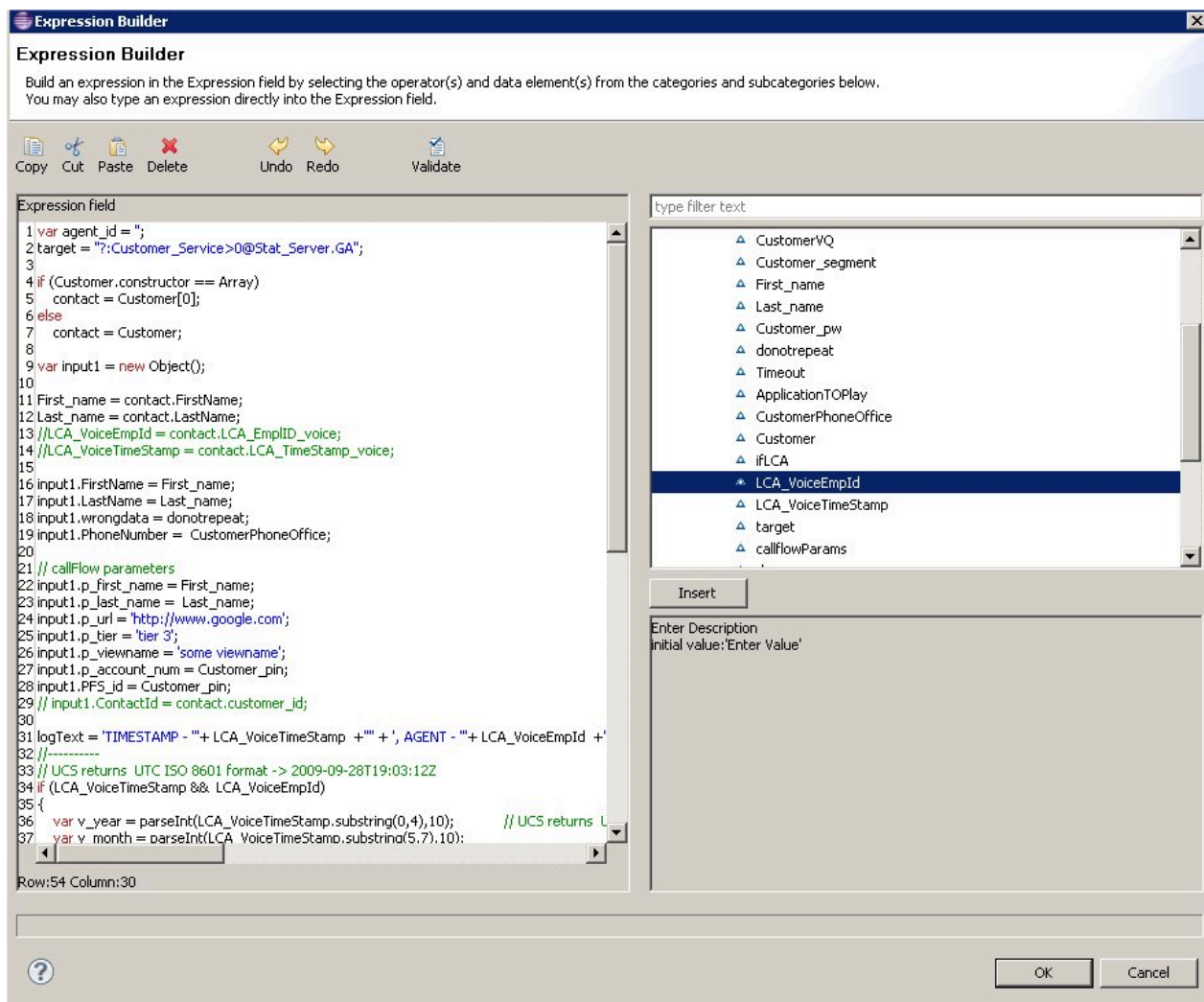

- If the last called agent is found, a **Branching block (4)** sends the interaction to another **Play Application block**.
- This Play Application block **(5)** prompts the customer: "Would you like to be connected to the agent that you spoke with previously? For yes, press 1. For no, press 2."
- If the customer presses 1, another Branching block **(6)** directs the interaction to a **Target block (7)**, which routes the call to the last called agent. If the agent is unavailable, the customer is given the option of a callback or waiting for the agent.

For more information on this particular sample and last agent routing in general, please contact Genesys Technical Marketing.

Validation, Debugging, and Deployment

This section contains information about the following:

- [Validating](#) your diagram files and other source files for completeness and accuracy
- [Debugging voice applications](#)
- [Debugging routing applications](#)
- [Deploying applications](#)

Validation

Composer can validate your diagram files and other source files for completeness and accuracy.

Validation Preferences

For information on setting Validation preferences, see the figure in topic [Project Properties dialog box. Select Validation.](#)

Prompts Resource Validation

In Diagram Preferences, Global Settings, the [Enable Validation for Prompt Resource preference](#) enables diagram validation warnings where prompt audio resources no longer exist in the given file path. If the audio file is no longer present, the diagram block will show a warning icon.

Diagram Validation

This topic covers both callflow/workflow diagrams and [interaction process diagrams](#) (IPDs).

Callflow/Workflow Validation

You can initiate standalone callflow or workflow validation in a couple of ways. When the callflow or workflow is saved and selected:

- **Diagram > Validate** from the menu.
- Click the Validate icon  on the upper-right of the Composer main window .

Note: In case of errors, the [Problems view](#) will become visible and error markers are put on the callflow or workflow blocks that contain errors. Double clicking on an error in the Problems view will take you to the corresponding blocks that contain the errors. Review each of the errors and do the fixes, then validate again. After validation, you can [generate code](#).

Interaction Process Diagram Validation

The validation process is basically the same for IPDs. When the IPD is selected or in view :

- **Diagram > Validate** from the menu.
- Click the Validate icon  on the upper-right of the Composer main window.

When invoked, validation checks for the existence of objects in Configuration Server and indicates the results. Validation does not make changes in Configuration Server as part of the process. Note: If Composer is not connected to Configuration Server, clicking the validation button brings up the **Connect to Configuration Server** dialog.

Source File Validation

There are two types of validation that can occur when you are working with source files in Composer Rich editors:

- Source validation
- Batch validation

Source validation occurs as you type your code; this validation reflects the "unsaved" and "unbuilt" contents of the source you are editing. Note: To turn source validation on (or off) for all structured text editors, click **Window > Preferences > General > Editors > Structured Text Editors** and check (or uncheck) **Report problems as you type**. Batch validation occurs on saved files. Batch validations may catch build process errors and other types of non-source validation errors. Batch validation can uncover errors in multiple files at once and give you a comprehensive view of where problematic code can be found in your project. Moreover, you do not need to open files in an editor to run batch validation. To run batch validation on specific files, select and right click the files in the Project Explorer and then select Run Validation from the popup menu. Note: To set preferences for batch validation, click **Window > Preferences > Team > Validation**.

Project Level Validation

You can validate a Project using the integrated Composer Validator, which is enabled or disabled at global level using the Validation preferences (**Window > Preferences > Team > Validation > Composer > Composer Validator**).

- Invoke Composer Validator on a Project or individual file by right clicking and selecting **Validate** from the pop-up menu.

Note: Automatic validation does not occur during any change in resource contents, since this action is taken care by the Composer Project Builders. You can enable or disable Composer Project Builders using the **Project > Build Automatically** menu option.

Project Level Validation Use Cases

Here are some possible validation use case scenarios:

- Validate all the callflow and workflow diagram files within the Composer Project.

- Validate all the referenced subroutines and subdialog diagram files, which have the corresponding .scxml / .vxml files generated inside the src-gen folder.
- Validate all the GBuilder files, which have the corresponding .grxml file generated within the Grammars folder.
- Validate all ASP.NET related resources within a .NET Composer Project.
- Validate all JSP related resources within a Java Composer Project.

Validating a Single Flow Diagram

Note:

- Starting with 8.1.4, Composer shows a warning when validating a workflow if some (potential) infinite loop is detected.
- Composer shows the developer (via [IPD Diagram properties](#)) the [Orchestration Server SCXML attributes](#) for infinite loop defense.

Problems View

To configure the contents of the Problems view to view only warnings and errors associated with the currently validated callflow/workflow:

1. Open the Problems View by selecting **Window > Show View > Problems**.
2. On the top right side of the Problems view, click the down arrow to display the View menu.
3. Select **Configure Contents**.
4. On the left side of the Configure Contents dialog box under Configurations, select **Errors/Warnings on Selection**.
5. Under **Scope**, click **On selected element and its children**.
6. Click OK.

For more information on this dialog box:

1. Select **Help > Contents**.
2. Open the *Workbench User Guide*.
3. Expand **Concepts > Views > Problems**.
4. Review the Problems View topic.

Debugging Routing Applications

Composer's ORS_Debugger provides real-time debugging capabilities for SCXML-based **Orchestration Server** (ORS) routing applications. The ORS Debugger is integrated within the workflow **designer** for making test calls, creating breakpoints, viewing call traces, stepping through an SCXML document/workflow, and debugging applications. Debugging can be started on an existing session or it can wait for the next session that runs the application at a given URL. Prior to debugging, set **preferences for the ORS Debugger**, which supports both Run and Debug modes.

- Using a **Run As > Run Configurations** launch configuration, metrics (**call traces**) are displayed and the application continues without stopping at any breakpoints. When the SCXML application executes, these metrics can describe, for example, state transitions, ECMAScript executions, and execution warnings or errors.
- Using a **Debug** launch configuration, debugging pauses at breakpoints, single-step through the code, inspect variable and property values, and execute any ECMAScript from the query console.

You can debug:

- A workflow built with Composer, or
- Any SCXML application or set of SCXML pages whether or not they were created with Composer.

Notes:

- You can export a launch configuration. From the File menu, select Export. Expand Run/Debug and select **Launch Configurations > Next**. The dialog box lets you select or browse for a launch configuration.
- Composer 8.1 uses TCP to send SIP messages (previous releases used UDP). This is not a configurable option.
- Also see **ORS Debugger Limitations**.
- For information on Debug Code Generation mode, see the figure in topic **Project Properties dialog box**.

Important



It is recommended that you don't use names ending with the terms *workflow*, *callflow*, or *ixnprocess* for your projects. Projects with names ending with the mentioned terms might not behave as expected when debugging.

Starting a Debugging Session

If using **Context Services**:

- Set Context Services parameters: **Window > Preferences > Composer > Context Services**. In [Context Services Preferences](#), specify the Universal Contact Server host and port.

In order to debug, a launch configuration must exist. There are various ways to create a launch configuration:

- Right-click on the diagram/SCXML file in the Project Explorer. Select **Run As > Run Configurations** or **Debug As > Debug Configurations**. (The difference between Run as and Debug as is explained at the start of this topic.) This opens a dialog box for creating a launch configuration for the [workflow diagram](#) or [SCXML files](#).
- Use launch shortcuts. Note: To automatically fill in a debug or run launch configuration, use launch shortcuts. Right-click on the diagram/file and select **Debug As Workflow** or **Debug as SCXML File**. Composer automatically fills in the launch configuration.
- On the main toolbar, there is a Debug  button and a Run  button. Clicking relaunches the most recently used launch configuration. You can also use the keyboard shortcuts **Ctrl+F11** (for Run) and **F11** (for Debug).
- If you click the down arrow on these buttons to drop down a menu, a history of recent launches appears.

All of the above are also available in the Run top-level menu.

ORS Debugger Limitations

Limitations of the ORS Debugger are as follows:

- Do not use the ORS Debugger in a production environment. Use the ORS Debugger only for development purposes. A Production Orchestration Server is always configured to not allow debugging.
- Interaction process diagram debugging is not supported. Code generated from an IPD can be debugged just like any other SCXML page.
- In SCXML debugging mode, the `<invoke>` tag will not step into the invoked SCXML page. Debugging will continue to the next element in the page currently being debugged.
- Debugging a [Play Application block](#) will not step into the associated Callflow diagram and will not launch a GVP debugging sessions. Instead debugging will continue on to the block after the Play Application block.
- Application variables are not displayed correctly in the [Variables View](#) in ORS Debugging Perspective if the value contains XML or variables that are of type E4X.

ORS Debugging Perspective

See [Debugging Toolbars](#) for information on the views and buttons.

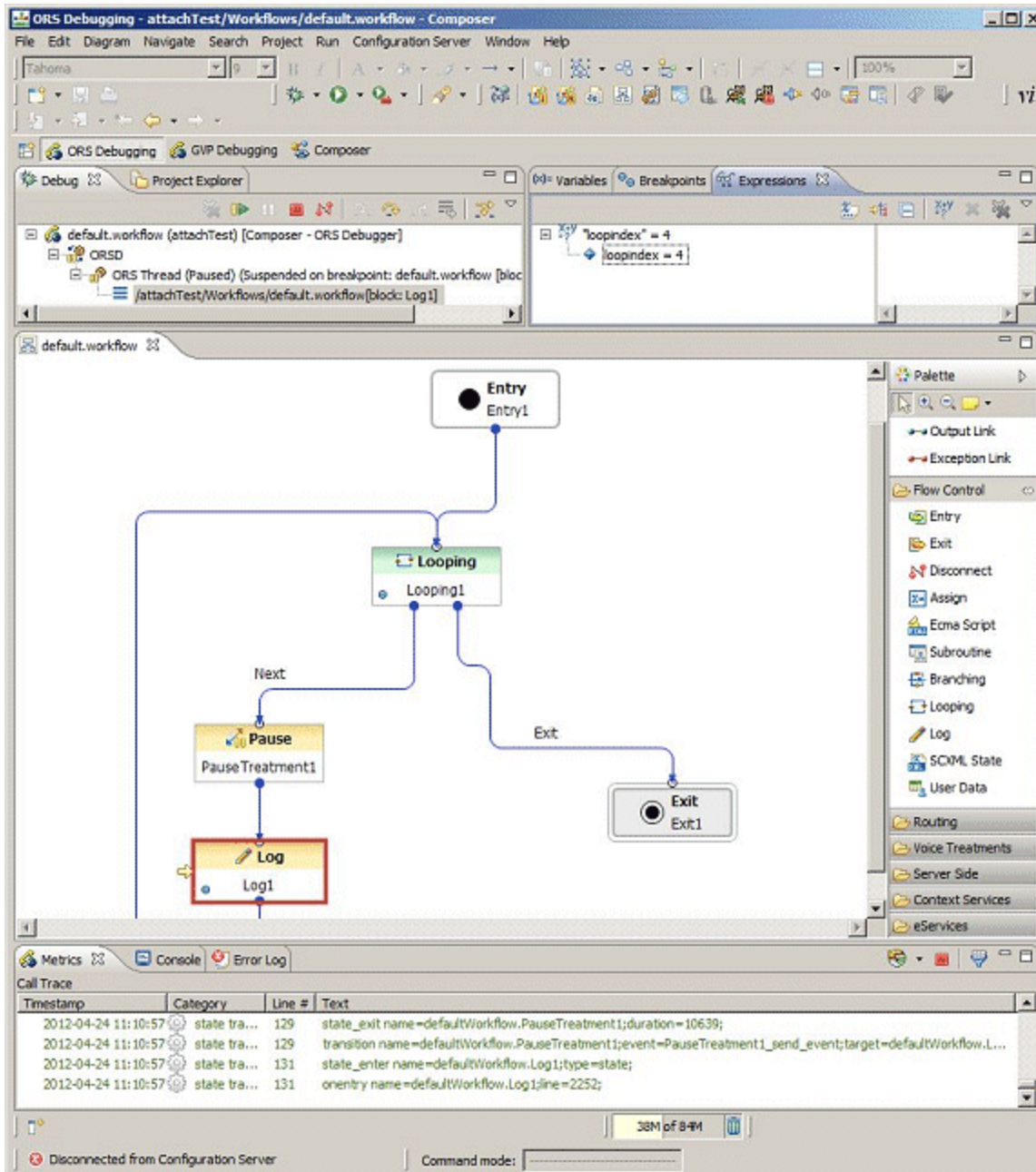

Debugging a Workflow Diagram

Workflow diagrams can be tested using the real-time ORS Debugger. Both **Run** and **Debug** launch configurations are supported, as well as **code and diagram modes**.

- In the Run mode, call traces are displayed and the workflow continues without stopping at any breakpoints.

- In the Debug mode, you can input breakpoints, single-step through the blocks, inspect variable and property values, and execute any ECMAScript from the query console.

Prior to debugging, you should have **validated** the workflow, **generated** the code, and **deployed** the Project for testing. Also, if you have not already done so, set **ORS Debugger preferences**. To start debugging, create a launch configuration for the file you want to debug. An example launch configuration is shown below.

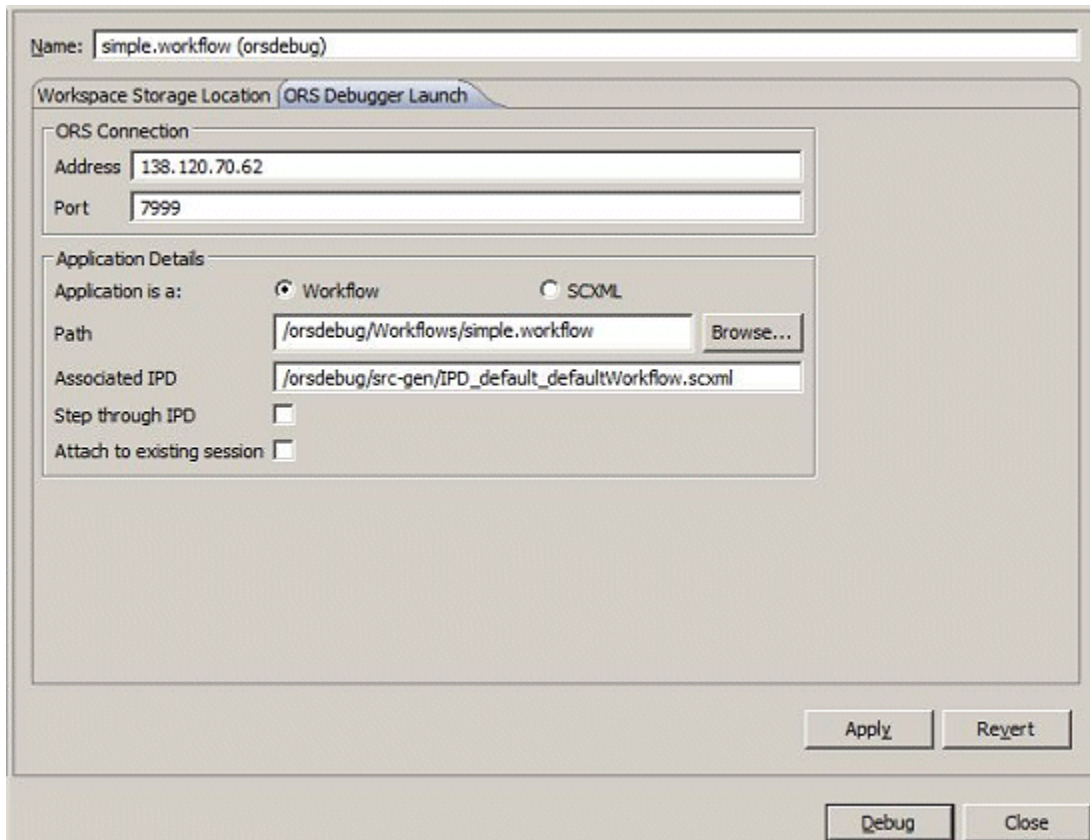

To automatically fill in the debug launch configuration described below, use launch shortcuts. Right-click on the workflow file and select **Debug As Workflow**. Composer automatically fills in the launch configuration.

Creating a Debug Launch Configuration

Note: See [Debugging a SCXML Files](#) if you want to view only call traces and not use breakpoints to step through the file. There are various ways to start a debug session. To test your workflow by **stepping** through it, use Debug Configurations to first create a launch configuration:

1. In the Project Explorer, expand the Composer Project and its workflows subfolder.
2. Right-click on the workflow filename in the Project Explorer and select **Debug as > Debug Configurations**. The Debug Configuration dialog box opens. Note: Debug As > Debug Configurations

sometimes does not appear for selection. The exclusion may also occur in other Composer scenarios and is an Eclipse IDE-related behavior. Should this occur, the workaround is to restart Composer.

3. Expand **Composer - ORS Debugger**.
4. Click the button for a new launch configuration or right-click and select **New**.
5. Name the configuration.
6. In the Workspace Storage Location tab, specify the Project name and location for saving SCXML pages executed by ORS. This folder appears in the **Location** field. Optionally, click **Create Automatically** to have the Debugger create a new Project folder to save the SCXML pages as the IPD is debugged. The files fetched may include SCXML pages, audio files, grammars, scripts, and SCXML data.
7. Click the **ORS Debugger Launch** tab.

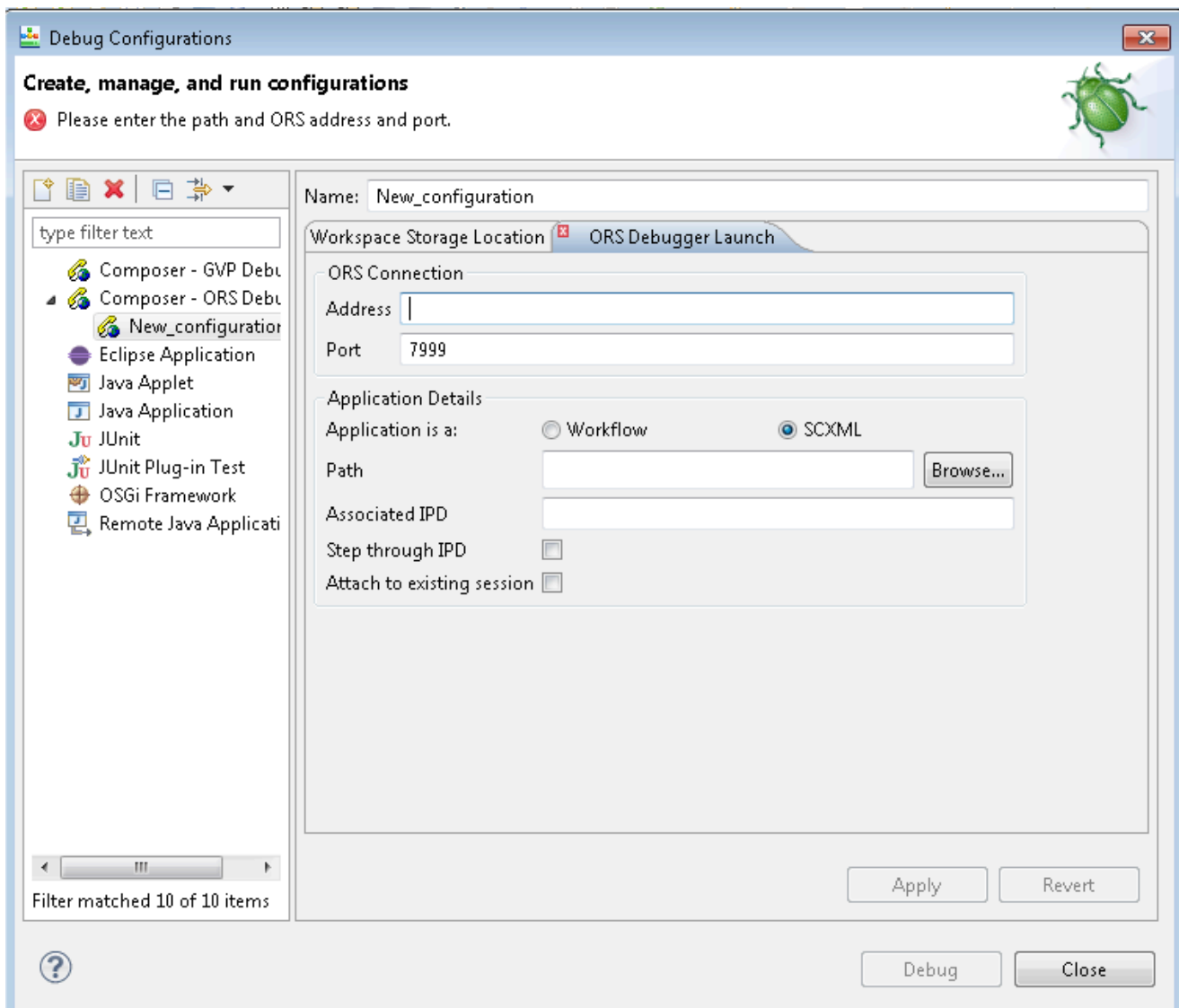

Note: Under **ORS Connection**, the IP **Address** and **Port** fields reflect the **ORS Server Host Name** and **ORS Server Port** previously entered as **ORS Preferences**, but can be changed.

1. **Address.** Enter the IP address or host name of the ORS server.
2. **Port.** Enter the debugger port of the ORS server. This is defined in ORS configuration as [scxml]:debug-port, and defaults to 7999. Make sure that ORS has debug-enabled set to true as well.
3. **Path.** Enter the workspace-relative path of the workflow diagram. For example, /MyProject/src-gen/IPD_default_defaultWorkflow.scxml.
4. **Application is a.** Select Workflow to step through the diagram or SCXML if **code**. If unchecked, it will **step** through the SCXML code.
5. **Associated IPD.** Enter the name of the **interaction process diagram** (IPD) associated with the workflow to be debugged. This field is optional because it is possible to run a stand-alone SCXML. Most of the time, you will use launch shortcuts (right-click on workflow or SCXML and select **Run/Debug As**). The fields in the launch configurations are filled in automatically.
6. **Step through IPD.** If enabled and debugging in **code mode** (as opposed to workflow mode), then the Debugger steps through the SCXML code that is generated from the IPD. Otherwise, it will "skip" through that code. The SCXML code generated from an IPD is generally setting up global variables and functions, so you might not want to go through that every time.
7. **Attach to existing session.** If enabled, ORS will start debugging on an existing session. When you launch the debugging session, Composer will prompt for a session ID in a dialog box. Once you enter the session ID, it will enter debugging mode for that session. If not enabled, ORS will wait for the next session that runs the application at a given URL. Note: The URL will point to the SCXML page that should be debugged. ORS will enter debug mode for the next session that is started for this URL.
8. Click **Apply** and **Debug** when ready.

After you launch, debugging doesn't start until ORS starts the session. You can start the session with a SIP call or multimedia interaction or using the ORS REST API (you need to send a POST request to ORS). The ORS Debugger skips over **deactivated blocks**.

Note: If the debugging session can't be started, a dialog box appears with an error message.

Stepping

Once debugging is initiated you will see a red box around the first block of the workflow. This indicates the current location where debugging is paused.

1. Step through the workflow. Click the Step Over  button to step through the blocks. See **Debug View**. Application state can be seen in the Variables tab.
2. You can input breakpoints from the **Breakpoints View/Toolbar** or use the context menu on a block and select **Toggle Breakpoint**. When breakpoints are set, you can press F5 or click **Resume** to resume the call to the next breakpoint, instead of stepping block-by-block.
3. You can change values of variables in the middle of a workflow. This could be used to quickly change the execution path as the call is progressing. Right-click in the **Expressions** tab and select **Add Watch Expression**.
4. In the Add Watch Expression window, add a new expression to watch during debugging.

To change the value, expand the variable, right-click on the child item and select **Change value**. A popup window as shown above will open, and you can specify the new value. Click **OK**. Proceed with debugging of the application and see the changed value.

Debugging-results Folder

The ORS Debugger creates a debugging-results folder in the Project Explorer. Clean up the debugging results by deleting the `ors-debug.<timestamp>` folders from the Project Explorer. Each `ors-debug.<timestamp>` folder corresponds to a single debug call that was made at the time specified by the timestamp. It contains files downloaded by the debugger. The `metrics.log` file contains the Call Trace of the call.

Debugging SCXML Files

SCXML files can be tested using the real-time ORS Debugger. Both **Run** and **Debug** launch configurations are supported, as well as **code mode**.

- In the Run mode, **call traces** are provided and the application continues without any breakpoints.
- In the Debug mode, you can input breakpoints, single-step through the SCXML code, inspect variable and property values, and execute any ECMAScript from the query console.

Tomcat engine is bundled as part of Composer and the application can be auto deployed and auto-configured for **testing**. Also, if you have not already done so, set **ORS Debugger preferences**. To start debugging, create a launch configuration for the file you want to debug. An example launch configuration is shown below.

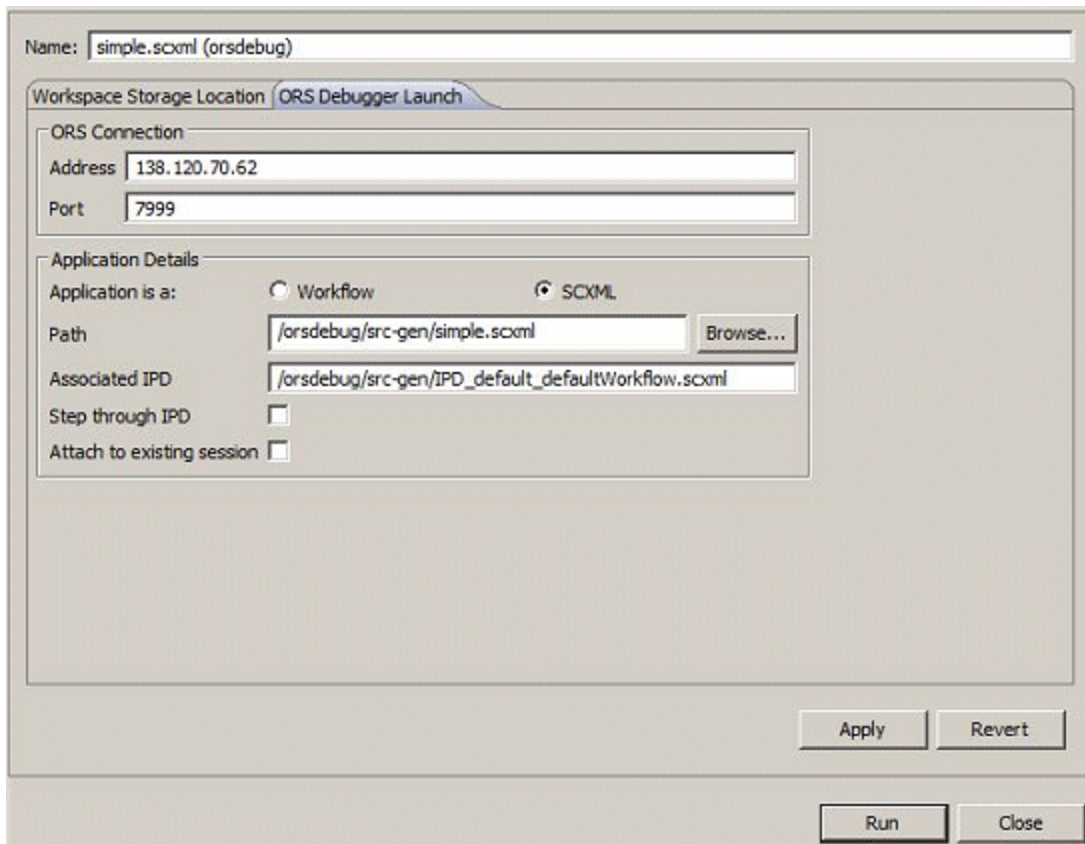

To automatically fill in the run launch configuration described below, use launch shortcuts. Right-click on the SCXML file and select **Run As SCXML Page**. Composer automatically fills in the launch configuration.

Creating a Run Launch Configuration

Note: See [Debugging a Workflow Diagram](#) if you want to use breakpoints to step through the file by creating a Debug launch configuration. To test your SCXML Files without breakpoints, use **Run Configurations** to create a launch configuration:

1. In the Project Explorer, expand the Composer Project and its src subfolder.
2. Right-click on the SCXML filename in the Project Explorer and select **Run As > Run Configurations**. The Run Configuration dialog box opens.
3. Expand **Composer - ORS Debugger**.
4. Click the button for a new launch configuration or right-click and select **New**.
5. Name the configuration.
6. In the Workspace Storage Location tab, specify the Project name and location for saving SCXML pages executed by ORS. This folder appears in the **Location** field. Or click **Create Automatically** to have the Debugger create a new Project folder to save the metric traces and SCXML pages as the file is debugged. The files fetched may include SCXML pages, audio files, grammars, scripts, and SCXML data.

Call traces are also saved in this location.

7. Click the **ORS Debugger Launch** tab.
8. Under **ORS Connection**, the Address and Port fields reflect the **ORS Server Host Name** and **ORS Server Port** previously entered as **ORS Debugger Preferences**, but can be changed.
9. **Application is a**. Select SCXML. Leave unchecked to step through the SCXML code. Select **Workflow** to step through a diagram.
10. **Path**. Enter the path for storing files downloaded during a debugging session. Specify the workspace-relative path of the SCXML file. For example, `/MyProject/src-gen/IPD_default_defaultWorkflow.scxml`.
11. **Associated IPD**. Enter the name of the **interaction process diagram** (IPD) associated with the SCXML file to be debugged. This field is optional because it is possible to run a stand-alone SCXML. Most of the time, you will use launch shortcuts (right-click on workflow or SCXML and select Run/Debug As). The fields in the launch configurations are filled in automatically.
12. Step through IPD. If enabled and debugging in **code mode** (as opposed to workflow mode), then the Debugger steps through the SCXML code that is generated from the IPD. Otherwise, it will "skip" through that code. The SCXML code generated from an IPD is generally setting up global variables and functions, so you might not want to go through that every time.
13. **Attach to existing session**. If enabled, ORS will start debugging on an existing session. When you launch the debugging session, Composer will prompt for a session ID in a dialog box. Once you enter the session ID, it will enter debugging mode for that session. If not enabled, ORS will wait for the next session that runs the application at a given URL. Note: The URL will point to the SCXML page that should be debugged. ORS will enter debug mode for the next session that is started for this URL.
14. Click **Apply** and **Run** when ready.

After you launch, debugging does not start until ORS starts the session. You can start the session with a SIP call or multimedia interaction or using the ORS REST API (you need to send a POST request to ORS). Note: If the debugging session cannot be started, a dialog box appears with an error message.

Debugging IPD SCXML Files

Interaction process diagram debugging is not supported. You can debug code generated from an IPD just like any other SCXML page (see **Debugging Modes**). Prior to debugging, you should have **validated** the workflow, **generated** the code, and **deployed the Project testing**. Also, if you have not already done so, set **ORS Debugger preferences**. **Creating a Debug or Run Configuration** The focus is on stepping through the workflow diagrams called from the IPD as the bulk of routing logic and decision making is done at the workflow level. IPD flows are straightforward and in most cases should not require debugging. To debug/run an IPD, you first create a launch configuration.

1. In the Project Explorer, expand the Composer Project and its Interaction Processes subfolder.
2. Right-click on a workflow diagram, and select **Debug As** or **Run As**. This will create a launch configuration automatically and start the debugging session.
3. Optionally, at a later time, you can go back to the launch configuration, and check Step through IPD if you want to step through the IPD as well.
4. Click the **ORS Debugger Launch** tab.

5. Under **ORS Connection**, the **Address** and **Port** fields reflect the **ORS Server Host Name** and **ORS Server Port** previously entered as **ORS Debugger Preferences**, but can be changed. **Address**. Enter the IP address or host name of the ORS server. **Port**. Enter the debugger port of the ORS server. This is defined in ORS configuration as [scxml]:debug-port, and defaults to 7999. Make sure that ORS has debug-enabled set to true as well. **Path**. Enter the workspace-relative path of the IPD SCXML file. For example, /MyProject/src-gen/IPD_default_defaultWorkflow.scxml.
6. **Associated IPD**. Enter the name of the **interaction process diagram** (IPD) associated with the SCXML file to be debugged. This field is optional because it is possible to run a stand-alone SCXML. Most of the time, you will use launch shortcuts (right-click on workflow or SCXML and select **Run/Debug As**). The fields in the launch configurations are filled in automatically.
7. Step through IPD. See Step 3. If enabled and debugging in **code mode** (as opposed to workflow mode), then the Debugger will step through the SCXML code that is generated from the IPD. Otherwise, it will "skip" through that code. The SCXML code generated from an IPD is generally setting up global variables and functions, so you might not want to go through that every time. Note: While debugging an IPD SCXML file, debugging skips over lines that include the workflow SCXML file using the `<xi:include>` tag. Workaround: None required. Debugging will step into the included workflow diagram or SCXML file.
8. **Attach to existing session**. If enabled, ORS will start debugging on an existing session. When you launch the debugging session, Composer will prompt for a session ID in a dialog box. Once you enter the session ID, it will enter debugging mode for that session. If not enabled, ORS will wait for the next session that runs the application at a given URL. Note: The URL will point to the SCXML page that should be debugged. ORS will enter debug mode for the next session that is started for this URL.
9. Click **Apply** and **Run** when ready.

After you launch, debugging does not start until ORS starts the session. You can start the session with a SIP call or multimedia interaction or using the ORS REST API (you need to send a POST request to ORS).

Note: If the debugging session cannot be started, a dialog box appears with an error message.

Stepping Through a Routing Application

Note: Step Over on the **Debugging Toolbar** is the only way to step for both routing and voice applications. Stepping means executing the workflow one step at a time, suspending execution between steps, and using variables, breakpoints, and watch expressions. You can then examine the state of the application when it is suspended. At each step of execution, the Debugger displays metrics (call traces) received from ORS. This topic covers the following:

Suspending Execution

When execution is suspended:

- ORS displays the text of the SCXML page currently being executed.
- Highlights the line that will be executed in the next step.

When you choose to step again, the next step is executed and execution is suspended again. For information on how to step and suspend, see the **Debugging Toolbars** topic.

Using Variables

The ORS execution context contains ECMAScript variables. Composer access these variables by using the Eval message.

- When execution is suspended, Composer displays the **workflow and project variables** in the current scope of the ORS execution. The variables are displayed in the Variables tab in **ORS Debugging Perspective**.
- If the variable is a complex ECMAScript object, You can expand it to view the contents of the object.
- You can create a watch expression from any variable or sub-object of a variable.

For more information, see the **Debugging Toolbars** topic.

Using Breakpoints

Breakpoints allow you to select a position in the SCXML application to suspend execution. Instead of stepping through execution, You may wish to resume the application, which means to run it until the next breakpoint is reached. You create a breakpoint on a line of the current page. A line breakpoint is reached if the execution reaches the line number of the breakpoint. Line breakpoints are allowed only on SCXML elements which support suspending. The following elements support suspending: onentry, onexit, invoke, transition, script, log, if, assign, raise send, cancel. If you try to create a breakpoint on an unsupported element, the breakpoint is moved to the next valid line. From the **Breakpoints View/Toolbar**, you can:

- Display a list of all current breakpoints and enable/disable them. If you disable a breakpoint by unchecking the box in the list of breakpoints, then execution is not suspended if that breakpoint is reached. You may also disable all breakpoints by clicking the Skip All Breakpoints action from the Eclipse Run menu.
- Remove a breakpoint.

Breakpoints are saved across sessions.

Using Watch Expressions

You create watch expressions to monitor the value of a given expression. The expression is an ECMAScript expression, e.g., a variable or function call, that is evaluated in the scope of current SCXML application. From the **Expressions View/Toolbar**, you can:

- Add a watch expression. The value of the expression is displayed immediately, and updated when the value changes.
- Modify the value of a variable in a watch expression. The change is then reflected in the SCXML application context.
- Disable a watch expression. When disabled, the watch expression value will not be updated.
- Remove a watch expression.

Debugging Modes

The ORS Debugger supports two debugging modes: Diagram and Code.

- **Launching** a workflow in Debug mode starts debugging in diagram mode.
- **Launching** a SCXML file in Debug mode starts debugging in code mode.

The table below summarizes the modes for different file types. Also see [ORS Debugger Limitations](#).

Debug File	Mode	Supported	Procedure to Launch
Interaction process diagram	As Code	Yes	Run/Debug as SCXML from an IPD SCXML. When debugging an SCXML file. Composer supports debugging of the SCXML document generated for the IPD diagram. It will not be a common use case to only debug the IPD.
Interaction process diagram	As Diagram	No	IPD debugging is not supported. Code generated from an IPD can be debugged just like any other SCXML page.
Workflow	As Code	Yes	Run/Debug as SCXML, from a workflow SCXML. This will basically still run the IPD SCXML but execution will pause at the <AppEntry> state of the workflow SCXML.
Workflow	As Diagram	Yes	Run/Debug as Workflow, from a workflow diagram. It will detect the associated IPD SCXML and run that.
Sub-Workflow	As Code	Yes	A subroutine cannot be debugged on its own. Put a breakpoint on the subroutine's Entry block and debug its calling workflow.
Sub-Workflow	As Diagram	Yes	A subroutine cannot be debugged on its own. Put a breakpoint on the subroutine's Entry block and debug its calling workflow.
Hand-coded SCXML	As Code	Yes	Should work identical to

			IPD SCXML debugging.
--	--	--	----------------------

Debugging Voice Applications

Video Tutorial

Below is a video tutorial on debugging VoiceXML applications.

Important

While the interface for Composer in this video is from release 8.0.1, the steps are the basically the same for subsequent releases.

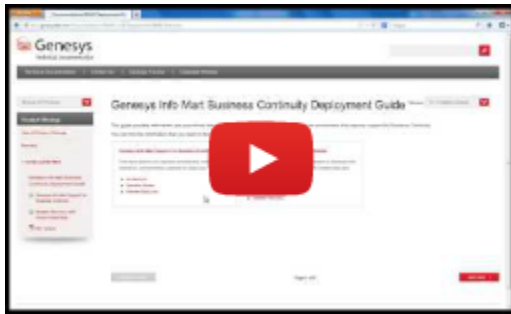

GVP Debugger

Composer's GVP Debugger provides real-time debugging capabilities for Genesys Voice Portal voice applications. The debugger is integrated with GVP for making test calls, viewing call traces, and debugging applications. It supports accessing SOAP and REST based Web Services. Database access is provided using server-side logic and a Web services interface. Prior to debugging, set **preferences for the GVP Debugger**, which supports both Run and Debug modes.

Run Versus Debug

- In the **Run mode** using **Run > Run Configuration**, **call traces** are provided and the application continues without any breakpoints.
- In the **Debug mode**, using **Debug as > Debug Configuration**, you can input breakpoints, single-step through the code, inspect variable and property values, and execute any ECMAScript from the query console.

Integration with a **SIP Phone** is provided with a click-to dial feature for making the test calls. You can

debug:

- A callflow built with [Composer](#), or
- Any [VoiceXML application or set of VoiceXML pages](#) whether or not they were created with Composer.

Notes:



- Previous to GVP 8.1.4, one instance of GVP's Media Control Platform (MCP) supported only one Composer debugging session. This limitation no longer exists in GVP 8.1.4.
- Debugging is supported only on Tomcat. VXML debugging is the same on any application server so debugging using Tomcat is sufficient.
- Composer 8.1 uses TCP to send SIP messages (previous releases used UDP). This is not a configurable option.
- For information on Debug Code Generation mode, see the figure in topic [Project Properties dialog box](#).

Starting a Debugging Session

If using [Context Services](#):

- Set Context Services parameters: **Window > Preferences > Composer > Context Services**. In [Context Services Preferences](#), specify the Universal Contact Server host and port.

You can start a debugging session in the following ways:

- Right-click on the diagram/VXML file. Select **Run As > Run Callflow** or **Debug As > Debug Callflow**.
- On the main toolbar, there is a Debug  button and a Run  button. Clicking relaunches the most recently used configuration. You can also use the keyboard shortcuts Ctrl+F11 (for Run) and F11 (for Debug).
- If you click the down arrow on these buttons to drop down a menu, a history of recent launches appears.

All of the above is also available in the Run top-level menu.

Debugging When Using Context Services

If using [Context Services](#), you must do the following before debugging a callflow or a VXML application:

1. Check the **Connect to the Universal Contact Server when designing diagrams** preference option in the [Context Services preference](#) page.
2. Set the UCS parameters [Context Services preference](#) page.

Composer then automatically appends an extra `context_services_url` parameter to the SIP URI.

This parameter is then read by the GVP application at runtime, enabling the GVP application to connect to the UCS.

GVP Debugging Perspective

The figure below shows Composer's elements for the GVP Debugging **perspective** (callflow debugging):

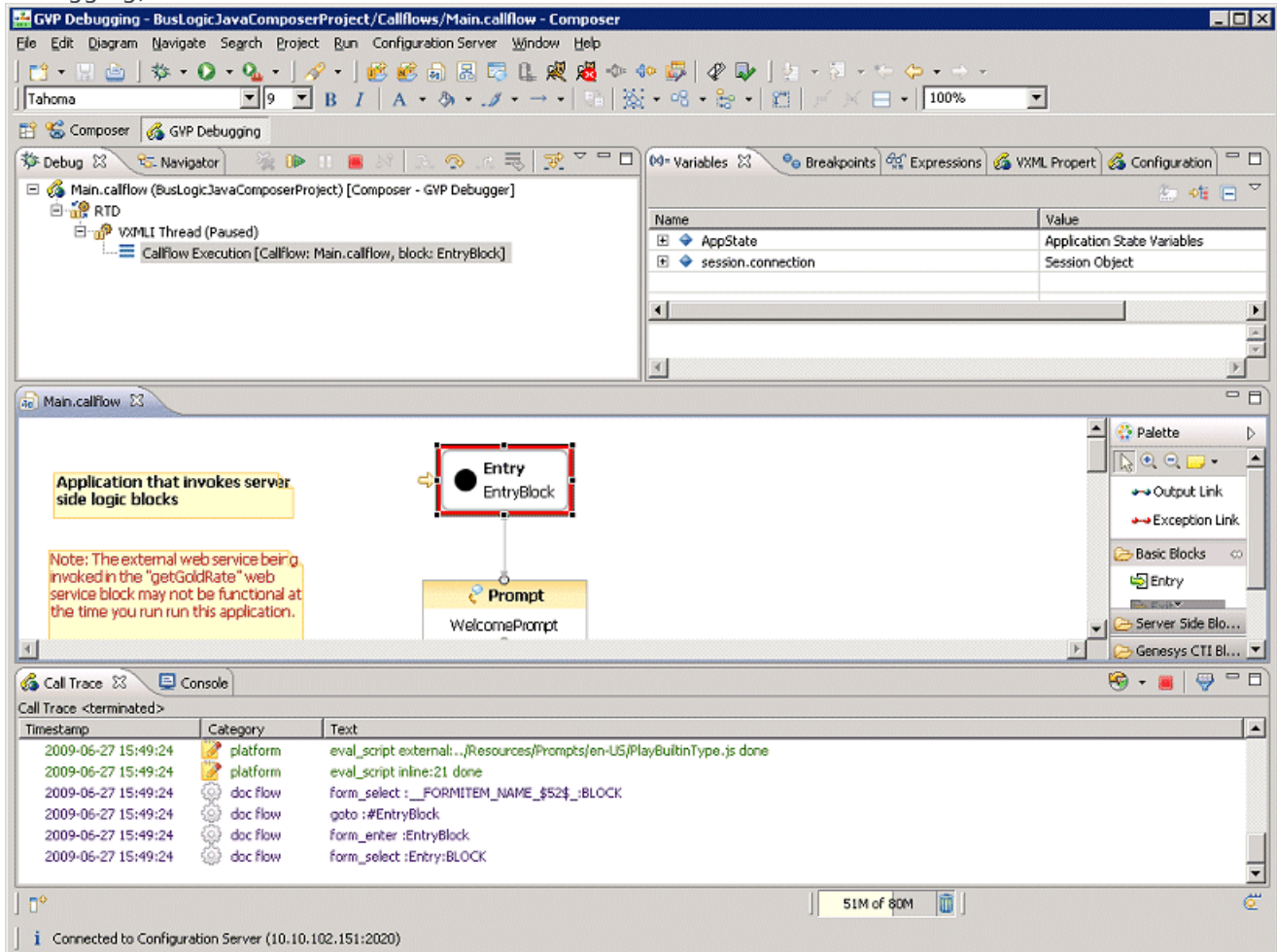

- The **Debug** view shows the callflow diagram name being debugged, as well as the status of the debug progress or result.
- The Navigator view shows the same Project folder structure shown in the Project Explorer window of the Composer perspective.
- The callflow diagram is displayed below if you are debugging a callflow. At the beginning of the debug session, a red box surrounds the Entry block of the callflow to indicate the start point. The focus changes as the session progresses, and a red box displays wherever the call execution suspends, regardless of whether or not there's a breakpoint.
- The **Call Trace** view displays metrics which describe the events occurring in the application, such as

recognition events, audio playback, user input, errors and warnings, and application output. The history functionality of the call trace view shows the call traces from past calls.

- The **Console** is for executing ECMAScript commands on the interpreter.

Debugging Tools

See the [Debugging Toolbars](#) topic.

Debugging Views

The upper right of [GVP Debugging Perspective](#) contains the following views:

- **Variables** allows you to monitor the state and value of any variable used in the application, to see how the variable changes during execution. This shows all global variables of the application, and also the recognition results of the previous recognition, if any.
- **Breakpoints** allows you to select a position in the VoiceXML application to suspend execution instead of stepping through the application one command at a time.
- **Expressions** indicates watch expressions you can add and monitor during execution. You can change the value of these expressions to see how they impact the application.

Note: The VXML Properties and Configuration views are for information only; they do not perform any tasks.

- **VXML Properties** are the properties defined in the VXML application by `<property>` tags. This includes application-specific properties (set in the [Entry block](#)) as well as default properties defined by the platform.
- **Configuration parameters** are the configuration items of the VXMLI. Basically it is what you would see in the `vxmli` section of the MCP settings in MF.

Debugging a Callflow

The GVP Debugger allows you to debug a callflow by single-stepping through the blocks. Prior to debugging, you should have [validated](#) the callflow, [generated](#) the code, and [deployed the Project for testing](#). Also, if you have not already done so, set GVP Debugger preferences. Select **Window > Preferences > Composer > Debugging > GVP Debugger** and configure the [GVP Debugger](#).

Creating a Debug Launch Configuration

To test your callflow by stepping through it, use Debug Configurations to first create a launch configuration: To run your callflow for debugging use Debug Configurations:

1. In the Project Explorer, expand the Composer Project and its callflows subfolder.
2. Right-click on the callflow filename in the Project Explorer and select **Debug as > Debug Configurations**.
3. Expand **Composer - GVP Debugger**.
4. Select **New Configuration**. The Debug Configurations dialog box opens. An example is shown below.

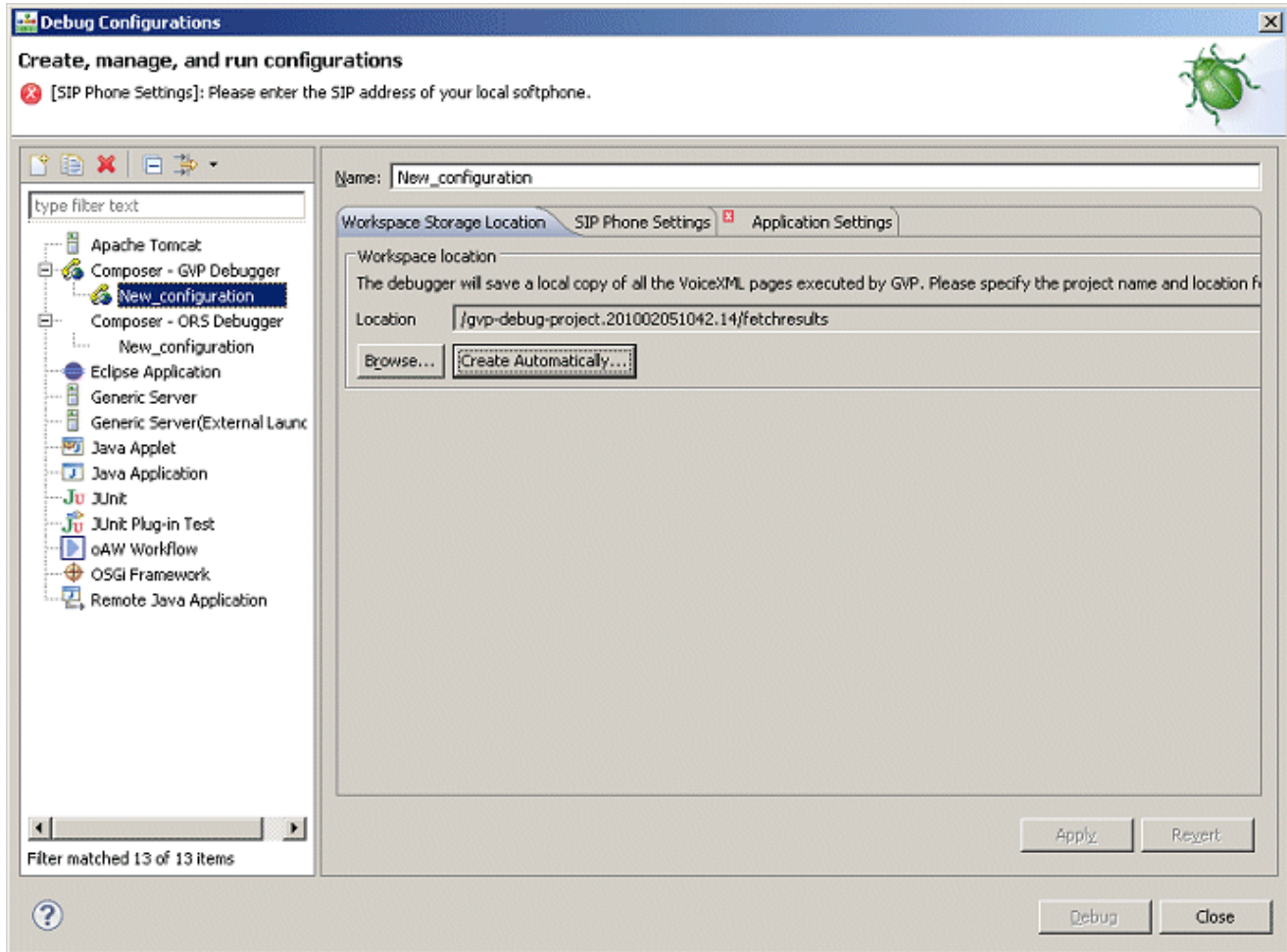

5. Name the configuration.
6. Click the **Create Automatically** button to create a new project folder to save the metric traces and VXML pages as the calls are being executed. This folder appears in the Location field as shown above.
7. Click the **SIP Phone Settings** tab and provide your SIP Phone information if not already there from GVP Debugger Preferences. An example is shown below:

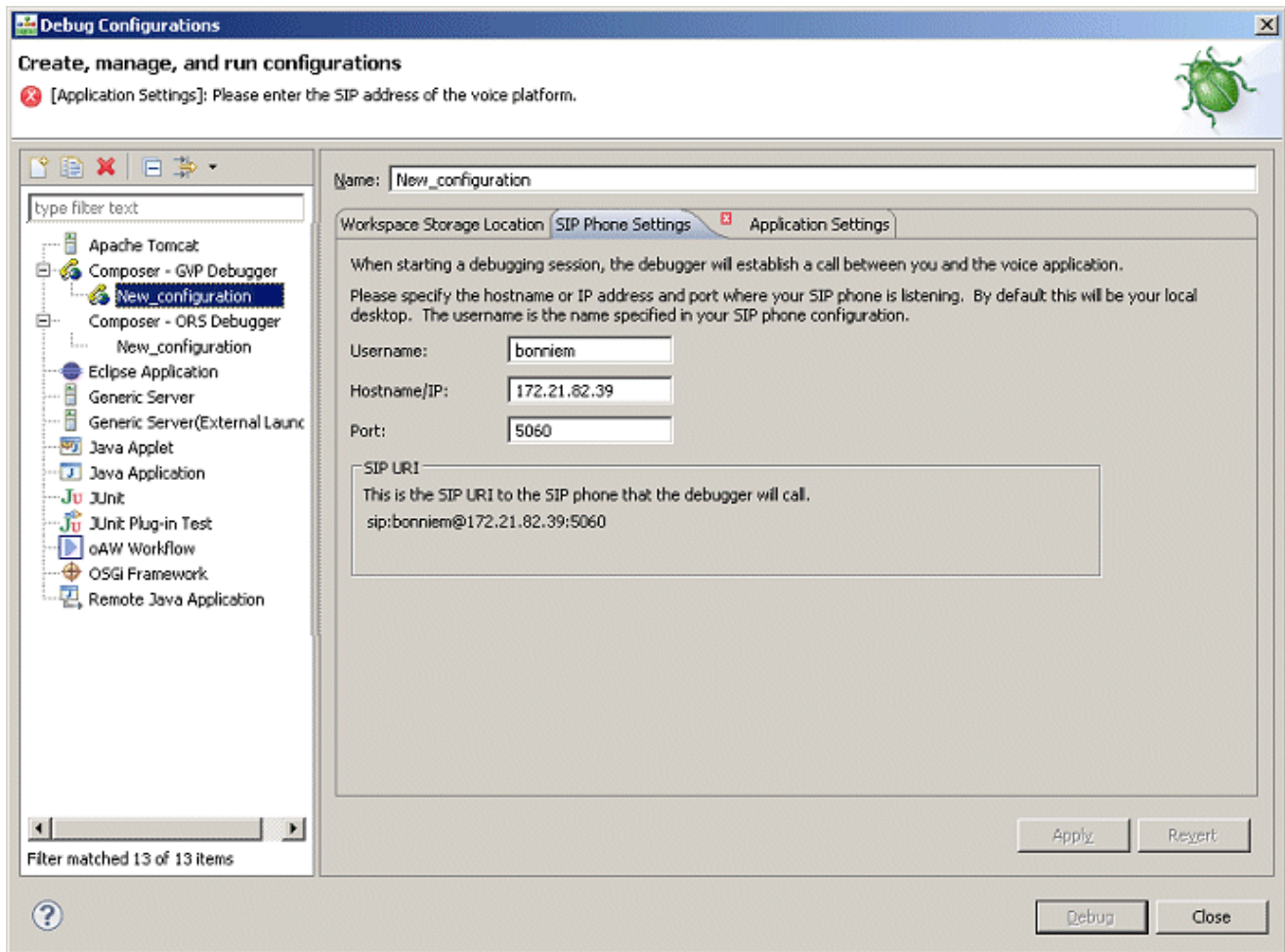

8. Click the **Application Settings** tab and select **Callflow Diagram**. An example is shown below:

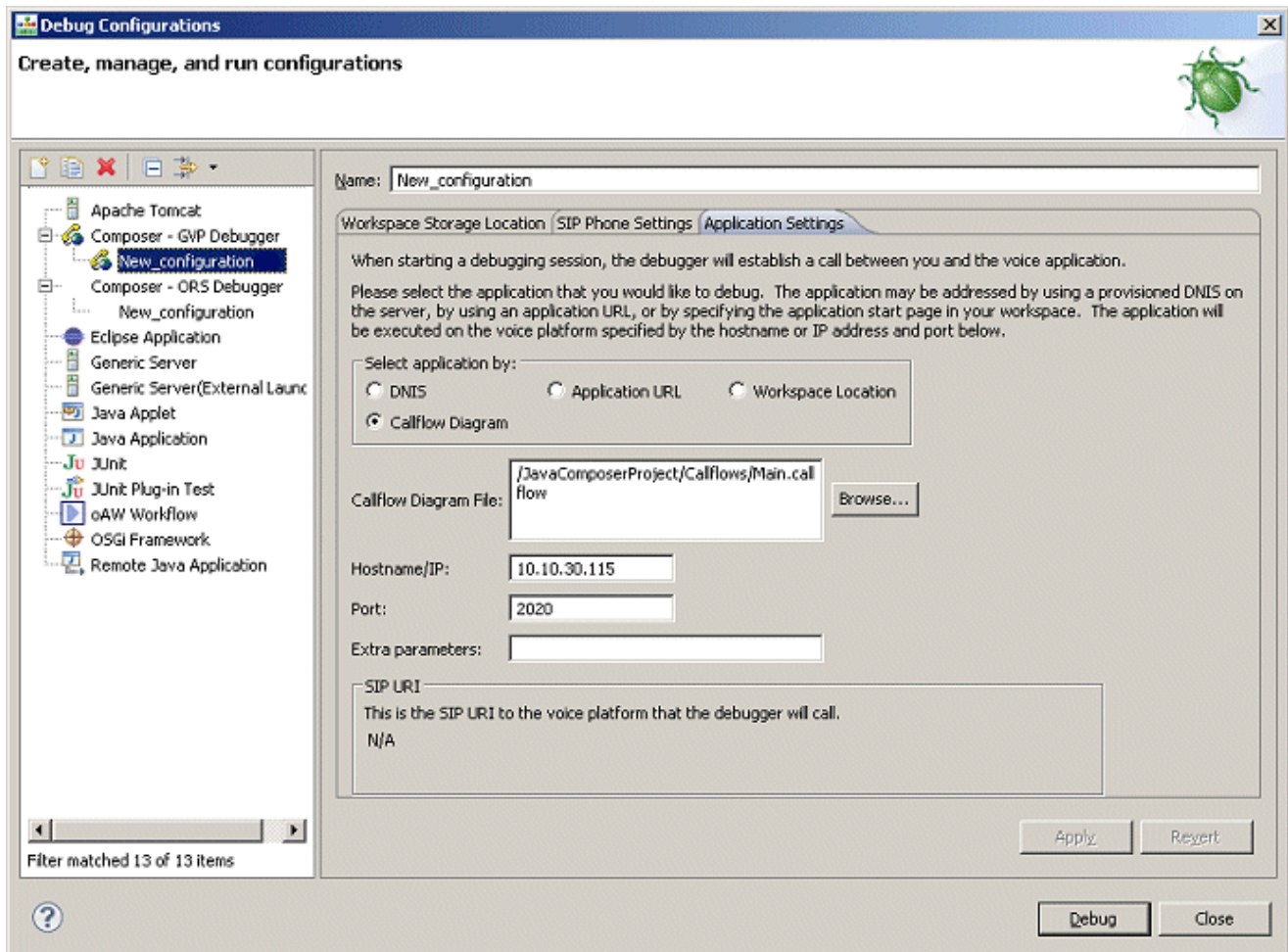

9. You can pass CTI Input variables in a Debugger call. Input variables in a callflow diagram can be initialized in a Debugger call using the **Extra Parameters** field in the Run / Debug Configurations > **Application Settings** tab. The Parameter names should match the "Input" variable defined in the **Entry Block** of the Callflow diagram.
10. Click **Apply**.
11. Click **Debug**. This will automatically dial out your SIP Phone.
12. Accept the call and you will be connected to the application on GVP. Composer switches to the GVP Debugging perspective.

Once the call is initiated you will see a red box around the first block of the application. This indicates the current location where the call is paused. Note: The GVP Debugger skips over **deactivated blocks**.

13. Click the **Step Over**  button to single step through the blocks. **Note:** Step Over on the **Debugging Toolbar** is the only way to step for both routing and voice applications. Blocks in the diagram correspond to <form> elements in the generated VXML. When stepping through a callflow diagram, the debugger is stepping through <form> elements in the underlying VXML. The call traces will become visible in the Call Trace view at the bottom. An example is shown below.

Timestamp	Category	Line #	Text
2011-03-22 16:39:32	platform	137	fetch_start script:http://138.120.72.35:8080/debugs
2011-03-22 16:39:32	platform	137	fetch_end Done (proxy-hit):http://138.120.72.35:80
2011-03-22 16:39:32	platform	137	eval_script external:../Resources/Prompts/en-US/en-
2011-03-22 16:39:32	platform	137	eval_script inline:21 done
2011-03-22 16:39:32	platform	137	compile_done :http://138.120.72.35:8080/debugsec
2011-03-22 16:39:32	doc flow	137	form_select :_FORMITEM_NAME_\$0\$_:BLOCK
2011-03-22 16:39:33	doc flow	146	goto :#Entry1
2011-03-22 16:39:33	doc flow	146	form_enter :Entry1
2011-03-22 16:39:33	doc flow	146	form_select :Entry:BLOCK

Application state and last user input values can be seen in the [Variables tab](#).

14. You can input breakpoints from the context menu on a block and select **Toggle Breakpoint** . When breakpoints are set, you can press F5 to resume the call to the next breakpoint, instead of single stepping block-by-block.
15. You can change values of variables in the middle of the callflow. This could be used to quickly change the execution path as the call is progressing. Right-click in the Expressions tab and select **Add Watch Expression**. In the Add Watch Expression window, add a new expression to watch during debugging. For example, give the name as AppState.<actual variable name>.
16. To change the value, expand the variable, right-click on the child item and select **Change value**. A popup window as shown above will open, and you can specify the new value. Click **OK**. Proceed with debugging of the application and see the changed value.The value of the watch expression can be refreshed at any time by right-clicking on it and selecting **Reevaluate Watch Expression**.

Debugging-results Folder

The GVP debugger creates a debugging- results folder in the Project Explorer. There is currently no automatic cleanup so the number of files can become large. Clean up the debugging results by deleting the gvp-debug.<timestamp> folders from the Project Explorer. Each gvp-debug.<timestamp> folder corresponds to a single debug call that was made at the time specified by the timestamp. It contains files downloaded by the debugger. The metrics.log file contains the Call Trace of the call.

Code Generation of Multiple Callflows

When using the **Run Callflow** or **Debug Callflow** functions, Composer automatically generates the VXML files from the diagram file that you want to run. In the case of a Java Composer Project that has multiple callflows, Composer attempts to generate the VXML for all the callflows before running (because the application might move between multiple callflows for subdialogs). However, if one of the callflows has an error, Composer provides the option to continue running the application anyway, because the erroneous callflow may be a callflow that's not used by the one being run (if there are two or more main callflows, for example). When this happens, the VXML files are basically out of sync

with the diagram files and this may affect execution. Genesys recommends that you fix all errors before running the application.

Debugging VoiceXML Files

- VXML debugging does not work on 64-bit operating systems when Transport Layer Security if TLS is enabled in **Context Services Preferences**. If TLS is not enabled, debugging works as expected.
- Debugging is supported only on Tomcat. VXML debugging is the same on any application server so debugging using Tomcat is sufficient.
- When subdialog calls external VXML page in debug mode, Composer throws the following error: An internal error occurred during: Debug Source Lookup. This is a known limitation. The problem occurs when stepping through a callflow with a subdialog block that links to a VXML page. A "mode switch" between debugging a callflow diagram and debugging a VXML page is not supported. Workaround is to start debugging the generated code instead as a VXML page, which will step into the hand written VXML page when it is called.
- VoiceXML applications can be tested using the real-time GVP Debugger. Support for both Run and Debug mode is provided.
- In the Run mode, the call traces are provided and the application continues without any breakpoints.
- In the Debug mode, you can input breakpoints, single-step through the VoiceXML code, inspect variable and property values, and execute any ECMAScript from the query console. Integration with a SIP Phone is provided and click to dial feature is provided for making the test calls.
- Tomcat engine is bundled as part of Composer and the application is auto deployed and auto-configured for **testing**. Programmers can test by specifying the DNIS of the application already provisioned in MF or provide the URL of the application or let Composer auto-configure the application for testing.

There are various ways to start a debug session. The next section describes Run Mode and Run Launch Configurations.

Creating a Run Launch Configuration

In order to test and debug applications configured in the Genesys Administrator Console as an IVR Profile, you will have to create a launch configuration for making test calls.

1. From the **Run** menu select **Run Configurations**.
2. In the dialog box, right-select **NGI Real Time Debugger** and select **New** from the menu.
3. Define the launch configuration. The figure below shows an example completed Workspace Storage Configuration tab.

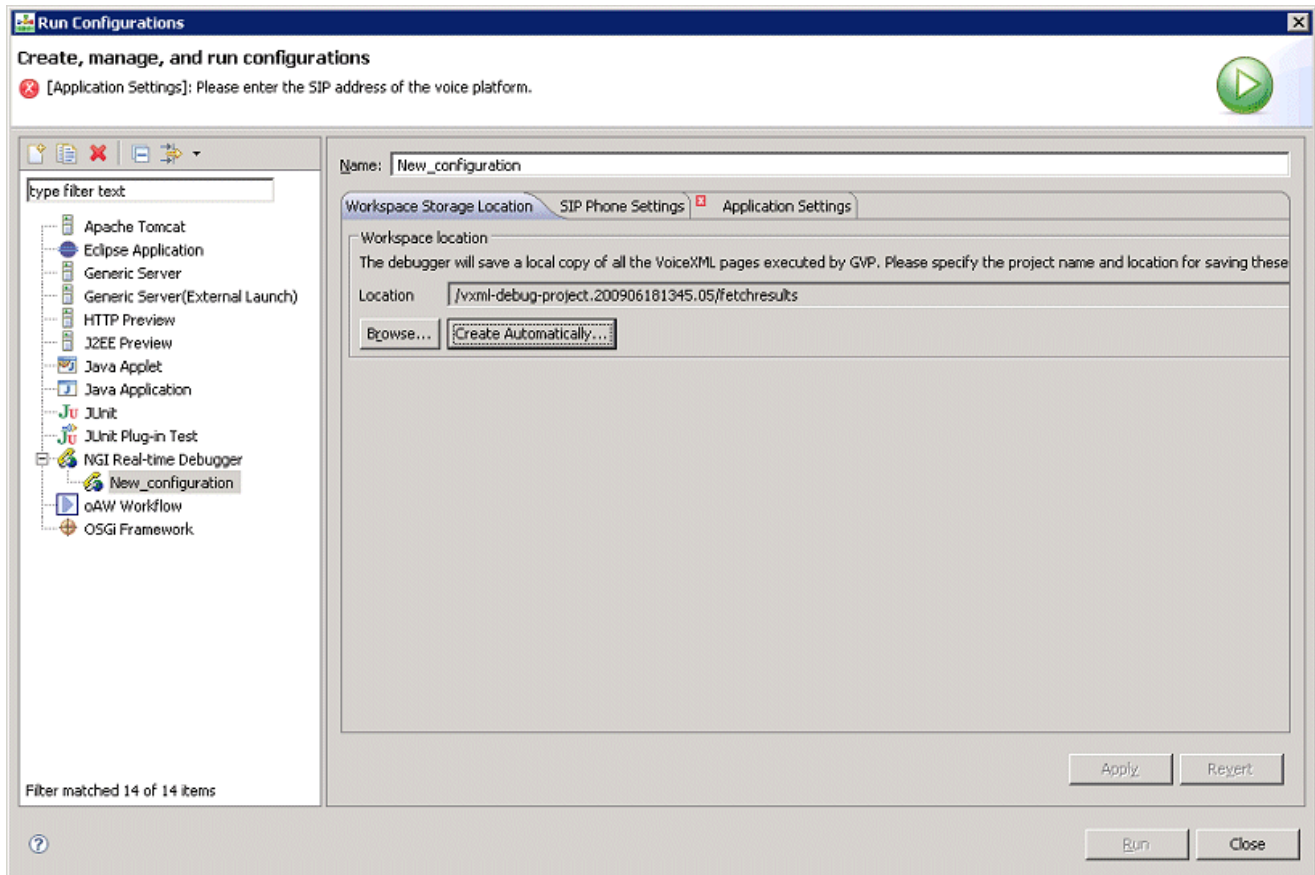

4. Click the **Create Automatically** button to create a new Project folder to save the metric traces and VXML pages as the calls are being executed. This folder appears in the Location field as shown above.
5. Click the **SIP Phone Settings** tab and provide your SIP Phone information if not already there. An example is shown below:

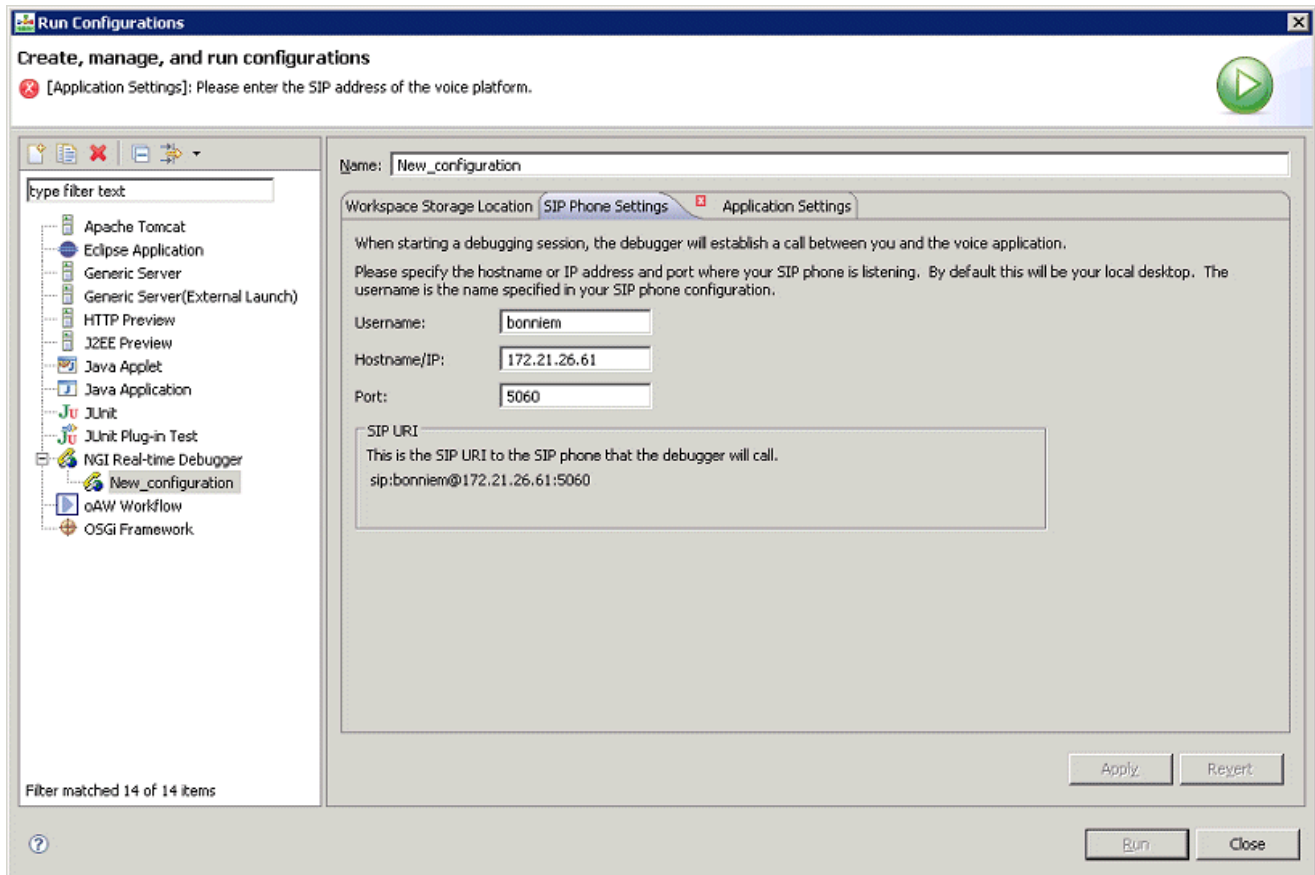

6. Click the **Application Settings** tab and select the **DNIS** option. Specify the DNIS of your application and the IP Address of your GVP (MCP / RM), as well as the port. An example is shown below:

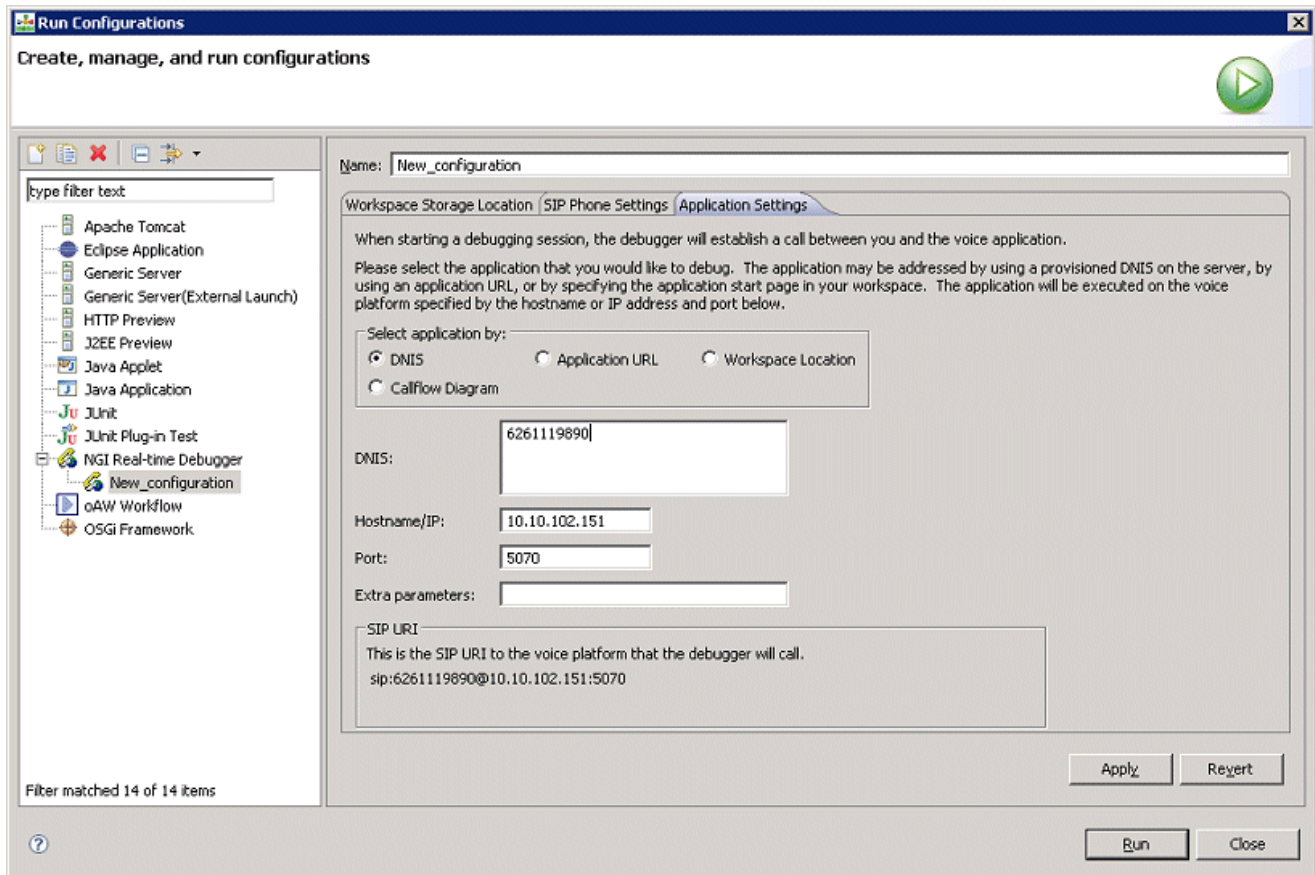

- The **Application URL** option is for an application that is not provisioned, but is hosted at an HTTP URL.
- The **Workspace Location** and **Callflow Diagram** options are generally not used to create launch configurations. Those launch configurations are automatically created using **Run As Callflow** or **Run As VXML file**.
- You can pass CTI Input variables in a Debugger call. Input variables in a callflow diagram can be initialized in a Debugger call using the **Extra Parameters** field in the Run / Debug Configurations > **Application Settings** tab. The Parameter names should match the "Input" variable defined in the **Entry Block** of the Callflow diagram.

7. Click the **Apply** button and then click **Run**.

8. Your SIP Phone should get dialed. Accept the call in your SIP Phone and then the Debugger will dial out to GVP and connect the call.

9. You should then see call traces in the Call Trace view.

Adding Breakpoints

To toggle breakpoints, double-click the side area of the Editor window as shown in the figure below:



Debugging Server-Side Pages

This section covers server-side debugging with the TCP/IP monitor. Composer includes a TCP/IP monitor which can be used to debug server-side code such as **Server Side** blocks and **Database** blocks. To monitor TCP traffic on the Tomcat or IIS port, follow these steps:

1. Check the Composer Preferences page to determine the port on which your bundled Tomcat is running. If you are using IIS, see the IIS port configured for Composer in Preferences.
2. Enable the TCP/IP monitor in Preferences (**Window > Preferences**, expand **Run/Debug** and select **TCP/IP Monitor**. Select the **Show the TCP/IP Monitor view when there is activity** check box.
3. Add a new monitor entry in TCP/IP monitor preferences. The Monitor section refers to the target being monitored. Use the configured port in the previous step as the port to monitor. For example, use 8080 and start the monitor.

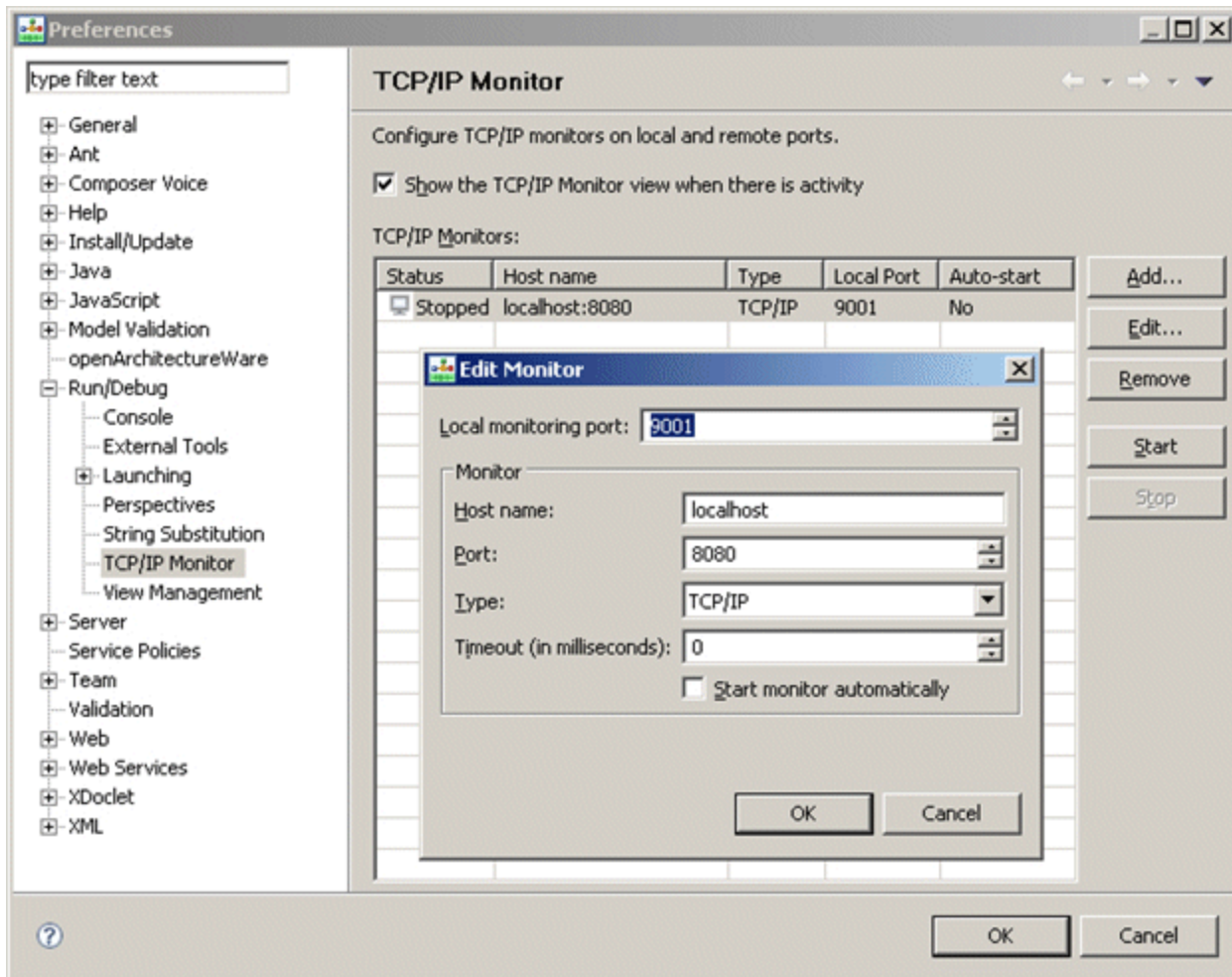

4. Update your Tomcat port / IIS port to the Local Monitoring Port.
5. Start debugging your application and put breakpoints on appropriate blocks. The debug perspective will start showing the TCP/IP Monitor view. If the view is not visible, access it from **Window > Show View**. The image below shows the bundled Database Stock Application being debugged. The TCP/IP Monitor view shows the error returned by server-side pages that handle database interactions.

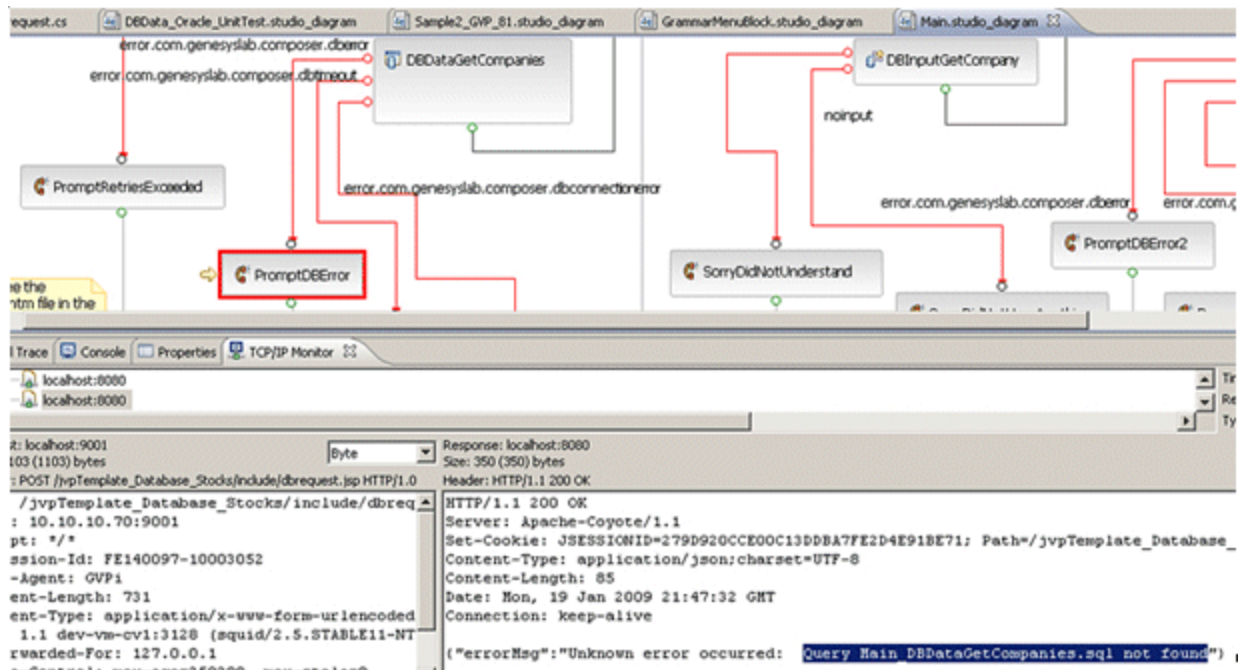

For additional information, see the following sections in the *Eclipse Workbench User Guide* Help available from within Composer (**Help > Help Contents**):

- TCP/IP Monitor view
- Defining TCP/IP Monitor preference
- Using the TCP/IP monitor to test web services

Debugging TLS Support

The instructions below describe how to (optionally):

- Configure a secure connection ([Use Secure Connection](#)) to GVP's Media Control Platform (MCP) during voice application debugging when using SIPS.
- Use a Transport Layer Security (TLS) connection for the Debugger control channel.

For additional information, see the *Genesys 8.1 Security Deployment Guide*. Note: MCP version 8.1.401.07 or later is required to use the TLS feature for debugging.

1. Import the certificate for MCP as follows:

- In the MCP's configuration, in section `vxmli`, there is a `debug.server.tlscert` parameter. (By default, this is `$InstallationRoot$/config/x509_certificate.pem`.) Copy this file from the MCP installation to a location on Composer's local machine.
- In Composer, go to **Window > Preferences**. Select **Composer > Security** in the tree. Click **Import Certificate** and navigate to the `x509_certificate.pem` file.
- Restart Composer.

2. Enable debugging from MCP configuration as follows:

- a. Set `[vxmli]:debug.enabled` to **true**.
- b. Ensure that `[vxmli]:debug.server.tlsport` and `[vxmli]:debugserver.tlsport.public` are set. (By default, it is set to port 27668.)
- c. In Composer, go to **Window > Preferences** and select **Composer > Debugging > GVP Debugger**. Check **Use Secure Connection** to enable security. The Platform Port setting should match the MCP configuration `[sip]:transport.2`.

Limitations

The GVP Debugger has the following limitations:

- **CTI** calls are not supported.
- Transfers of type blind and consultation do not work when a test call is made using the GVP debugger. The call will reach the **Transfer block**, but then it will hang and not proceed so you will need to terminate the call or debugging session manually.

A partial workaround is to set the Transfer Method property to bridge (i.e., **Transfer Type** = blind/consultation, **Method** = bridge) before debugging. The transfer will proceed, but the debugging session and the call will terminate immediately afterwards. Genesys recommends that you do full testing for Transfer applications by provisioning the application in Genesys Administrator and making test calls directly from the SIP phone. These limitations apply to **Run Callflow** (in Run mode) as well.

Deploying Composer Applications

Consult the [Composer 8.1.5 Deployment Guide](#) for Composer product installation information. This topic describes deploying a Composer application to a web server.

Video Tutorial

Below is a video tutorial on exporting and deploying a Composer application to a web server.

Important

Important Note: While the interface for Composer in this video is from release 8.0.1, the steps are the basically the same for subsequent releases.

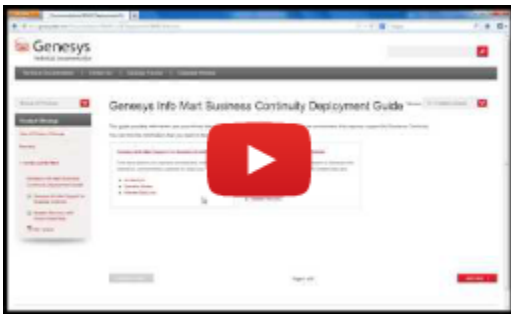

Deploying to Apache Tomcat Server for Testing

For testing purposes, Composer supports automated deployment of routing applications to the bundled Tomcat server or to a local IIS server. For more information, see [Testing Your Application](#).

Migrating a Composer Application From Lab to Production

Automated deployment of a Composer Project application to application servers from within Composer (JBoss, Websphere, and IIS) is not directly supported. The Composer [remote deployment](#) option can be used for Java Composer Projects to deploy directly to remote machines. For more information, see the section on [application server requirements](#) in the *Composer 8.1.4 Deployment Guide*.

For the Web Service block, the [Service End Point Variable Property](#) can be used to externalize the

Web Service URLs for production environments.

Deployment to a Web Application Server

Deployment to a web server depends on which type of Project you are working with:

- [Java Composer Project](#)
- [.NET Composer Project](#)

Once your application has been unit tested you will need to deploy it to a web server. The deployment process involves:

1. Exporting your Project
2. Transferring the files to your web/application server
3. Executing any necessary configuration steps required to make your application work.

For Composer-generated applications that use .NET resources, you can use any version of Microsoft IIS that is compatible with the Windows versions on which Composer is supported or any web server that supports Java Runtime Environment 1.7.0_0 or higher.

Combination Routing and Voice Projects

A single Composer Project can contain both routing and voice elements. If this is the case, the application will get deployed on a single application server (such as IIS or Tomcat), but must be provisioned in [Genesys Administrator](#) in two places:

- In GVP for the voice elements. See the chapter, Post Installation Activities on the GVP Hosts, Provisioning the Components section, in the [Genesys Voice Platform 8.1 Deployment Guide](#).
- In URS for the routing elements. See the chapter, SCXML Strategy Support, in the [Universal Routing 8.1 Deployment Guide](#).

Microsoft IIS Application Servers

Deploying an Composer application to a Microsoft IIS application server requires Administrative privileges when running the Microsoft Windows 7 and Microsoft Windows Server 2008, 32-bit operating systems.

Exporting a Java Composer Project for Deployment

Java Composer Projects can be exported to a location in the local machine and then manually

deployed to any web application server that meets the following minimum pre-requisites:

- Must be J2EE 5 compliant.
- Must support the JSP 2.1/Servlet 2.5 specification (such as Tomcat andJBoss application servers).

Exporting a Java Composer Application to an Application Server

1. Select **File > Export**, expand the **Composer** folder, then select **Java Composer Project as WAR file** and click **Next**.
2. Select **Export Composer WAR file to a location** and click **Next**.
3. Select the Java Composer Project that you wish to export and specify the information below.
4. Enter **WAR Display Name**. This is the name that will be used for the application when it is deployed (for example, Tomcat Manager will show this name).
5. Enter **File system destination**. Enter the location on the local machine where the war file will be saved.
6. **Generate code for Composer diagrams**. Select the check box if you would like to auto-generate the code for all the callflows/workflows before exporting the .war file.
7. **Create Revision**. Select the checkbox and select **Major**, **Minor**, or **Micro**. This will be recorded in the Project history and can be reviewed later.
8. **Contributor** (Optional). Typically the username of the person exporting the Project.
9. **Comment**. Enter any comments associated with this operation. Typically these will indicate why a new version was exported.
10. Click **Finish**.

A file with the same name as the name of your Java Composer Project and file extension as .war will be created in the destination location. The .war file name is always set to the Project name. The display name is not the file name. It is the application display name used by an application server when the .war file is deployed in it. See the web.xml file in the WEB-INF folder in the generated .war file. It will contain the specified display name. When exporting a .war file, the display name is saved on a per-Project basis. Subsequently, when exporting the same Project, the saved name is pre-populated.

Once the .war file is exported, deploy the .war file in your Production server or JBOSS server manually. For example, typically, you will upload the file via Tomcat Manager or drop the file into the webapps folder of your Tomcat server. If your server is configured to auto-expand the files, you will see a folder created with the same name as your voice Project. If auto-expand is not configured you will have to stop and start your web server in order to expand the .war file.

Generating and Deploying a WAR file to a Remote Web Server

Use this option to export a .war file to a remote application server from within Composer. It removes the need to manually copy over the file to the application server to deploy it.

1. Select **File > Export**, expand the **Composer** folder, then select **Java Composer Project as WAR file** and click **Next**.
-

2. Select **Generate and Deploy a WAR File to a Web Server** and click **Next**.
3. Select the Java Composer Project that you wish to export and specify the information below. The descriptions listed in the previous section applies here as well and are therefore not repeated.
4. **Web Container:** Select your target application server.
5. **Web Server installed location:** This is required for JBoss only. It is the location where the JBoss 711 application server was unzipped. It requires a file mapping to this location. Note: Only JBoss 711 version is supported for remote deployments.
6. **Generic Cargo configuration properties:**
 - **Host IP** – IP address of the host where the application server is currently deployed.
 - **Port No** – Webserver port.
 - **Username, Password** – Application server credentials required to deploy the application.
7. **Custom Cargo Configuration Properties:**
 - **Cargo** – Used by Composer for this remote deployment. Introduces additional capabilities, which can be specified via this option. Please refer to the [Cargo documentation](#) for details.
8. Click **Finish**.

Composer will generate a .war file and attempt to deploy to the specified remote application server. The information in the previous section also applies.

Deploying a NET Composer Project

.NET Composer Projects developed with Composer can be deployed on the IIS web application server.

- If you rename a .NET Composer Project, the new Project is not automatically deployed to IIS. The workaround is to undeploy the Project before renaming and then deploy manually after renaming.
- To deploy Composer .NET Projects to IIS, the IIS 6 Metabase Compatibility must be installed.

To deploy a voice application on IIS:

1. Generate the code for your project.
2. Right-click on your project and click **Export**.
3. In the Export dialog box, select **General > File System** and click **Next**.
4. Select all folders except simulation, callflows, and debugging-results.
5. In the To directory box, select the location in your file system where you want to export the application. Select the option for **Create only selected directories** then click **Finish** to export.

All your Project files should be exported to the location that you specified.

6. You can copy this folder to your final deployment machine.
7. Create a virtual directory for this application in IIS and point it to this folder:

- In **Virtual Directory Alias**, specify the name that will be used to access this virtual directory from HTTP, then click **Next**.
- Browse to the folder that has your application's exported contents, then click **Next**.
- Give the following permissions: **Read, Run Scripts**.
- Configure the Mime types for the deployed .NET Composer Projects manually. The following mime types should be added: .grx
- Open IIS and select the website you want to use. Right-click it and select **New Virtual Directory**. A wizard dialog will be displayed. Click **Next** to start it.
- ml and .vxml

To add a mime-type, open Internet Services Manager and follow these steps:

- Right-click your website (such as Default Web Site) and select properties.
 - Click the HTTP Headers tab.
 - Click the **MIME Types** button to display the MIME Types dialog box.
 - Add these MIME types:
 - .grxml application/srgs+xml
 - vxml text/xml
 - Make sure that ASP.NET extensions are enabled in your IIS.
 - Make sure that ASP.NET is enabled on your virtual directory and set to the correct version.
 - Make sure that scripts have execute permissions on your virtual directory.
8. Right-click on the main vxml page in your src-gen folder and select **Browse**. If all settings are correct, a browser window will open and show you the VXML page. The address in the browser will be the URL at which your VXML application will be available.

Deploying a Routing Application

Deploying routing applications involves two main tasks.

1. Creating the appropriate objects in Configuration Server that are required by the Universal Routing platform. These objects are needed so that the platform understands how to direct interactions (voice or multimedia) as well as how to process them.
2. Generating SCXML pages accessible to the platform so they may be retrieved and processed by the platform.

You can handle both tasks in Composer using its integrated development environment.

- **Publishing** interaction process diagrams (IPDs) creates most necessary Configuration Server objects.
- Deploying Composer Projects to local application servers (Tomcat for Java Composer Projects and IIS for .NET Composer Projects) makes application SCXML pages available to the platform.

However, Composer does not support deploying applications to a production environment. The steps documented below can be used to do that.

The term object is used (e.g., Interaction Queue object) when referencing Configuration Server objects. When blocks in Composer diagrams are referenced, the term block is used (e.g., Interaction Queue block). To deploy a routing application:

1. **Deploy your Composer-generated SCXML pages** to an application server. Note the URL of the **starting SCXML page**.
2. Using Genesys Administrator or Configuration Manager, log into the Configuration Database and connect to the Configuration Server that is being used for the environment in which you wish to deploy this application.
3. Create the Configuration objects listed below. All objects must be created under the appropriate Tenant that owns Configuration objects being referenced in your Workflow blocks like Queues, Standard Responses, and so on.
 - a. One Script object for each **Workflow** block in your IPDs. The object type should be EnhancedRouting. This applies to workflows that process voice or multimedia interactions.
 - b. One Script object for each **Interaction Queue** block in your IPDs. The object type should be Interaction Queue. This applies only to IPDs/ workflows that process multimedia interactions.
 - c. One Script object for each **View** defined in Interaction Queue blocks in your IPDs. The object type should be Interaction Queue View. This applies only to IPDs/ workflows that process multimedia interactions.
 - d. A media server **Endpoint** for each newly added Endpoint in any **Media Server** block in your IPDs. This applies only to IPDs/ workflows that process multimedia interactions.
 - e. For any E-mail or SMS servers being referenced in Media Server blocks in your IPDs, configure the appropriate POP accounts to route multimedia interactions to the appropriate media server endpoints. This applies only to IPDs/ workflows that process multimedia interactions.
 - f. Configure DNS to point to an EnhancedRouting object so that voice calls on those DNS invoke the application that is referenced in the Enhanced Routing object. This applies only to IPDs/ workflows that process voice interactions.

Detailed Steps for Creating Configuration Server Objects

The steps are listed below.

1. Common steps to create aScript object of a specific type:
 - Create a new Script object.
 - Ensure that the correct object type is set e.g. InteractionQueue or EnhancedRouting.
 - Set the object state to Enabled.
 - Check that the object is being created under the correct Tenant object.
2. Creating Script objects for Workflow blocks.
 - In Genesys Administrator, navigate to **Provisioning > Routing / eServices > Orchestration**.

- Create a Script object of type Enhanced Routing. The name can be the name of your Workflow block. If another object already exists by this name, you can use a different name.
- Specify the URI. It should be the URL of the [starting SCXML page](#) of your application.
- Add a parameter: `context_management_services_url`. Its value should be in the format: `[http:// http://]<UCS application host>:<Context Services port>`.
- Additional parameters can be specified here. If the names match the names of any [Project level variables](#), those variables will be initialized with values specified here.

3. Creating the Script object of type InteractionQueue.

- In Genesys Administrator, navigate to **Provisioning > Environment > Scripts**.
- Create a Script object of type Interaction Queue. The name can be the name of your Interaction Queue block. If another object already exists by this name, you can use a different name.
- In its Annex, create the following sections and keys:

Annex Section	Property	Equivalent Composer Block	Value	Notes
Namespace	Name	Name	<name of the queue>	
Namespace	Description	Queue Description	<descriptive text for the queue>	
Orchestration	Application	--	script:<name of the Enhanced Routing object to which interactions from this queue should be sent	Connects an interaction queue to an Enhanced Routing object. Equivalent to linking an Interaction Queue block to a Workflow block in an IPD.

4. Creating the Script object of type Interaction Queue View.

- In Genesys Administrator, navigate to **Provisioning > Environment > Scripts**.
- Create a Script object of type InteractionQueueView. The name can be the name of your view defined in an Interaction Queue block. If another object already exists by this name, you can use a different name.
- In its Annex, create the following sections and keys:

Annex Section	Property	Equivalent Composer Block	Value	Notes
View	Name	Name	<name of the queue>	
View	Queue	Parent Interaction Queue block	<name of the Interaction Queue object in	Connects the Interaction Queue View object with

			Configuration Server	its parent Interaction Queue object
View	Description	Description	<descriptive text>	
View	Freeze Interval	Check Interval		
View	Condition	Condition		
View	Order	Order		
View	scheduling mode	Scheduling		
View	"Condition.<Name>"	Parameterized Conditions	<value>	
View	sql-hint	Database Hints		
View	segment-by	Configured Segments	Value will be "value of segment 1, value of segment 2, ..., value of segment n"	Segment names are not used
View	segment-check-interval	Segment Interval		
View	segment-total-limit	Segment Limit		

5. Creating Media Server Endpoints

- In Genesys Administrator, navigate to the correct Application object representing your media server application of type EmailServer or SMSServer.
- For EmailServer and SMSServer applications, Endpoints are created in the endpoints:<tenant dbid> section which is specific to a Tenant.
- For each Endpoint, add a key in the above section with
 1. Key name = <Endpoint name>
 2. Value = <name of the Interaction Queue object to which interactions coming from this Endpoint will be submitted>

This defines an Endpoint and connects it to an interaction queue.

- Once an Endpoint is hooked up to an Interaction Queue object, all interactions coming in from that Endpoint are directed to the connected interaction queue. This object, in turn, is linked to an EnhancedRouting object from where the URL to the application is picked up. This completes the flow from the media server to the application SCXML pages.

6. Configuring POP accounts (EmailServer).

- In Genesys Administrator, navigate to the correct application object representing your media server application of type EmailServer.
- Accounts defined in EmailServer need to be configured to send e-mail interactions to specific Endpoints. For this, locate the pop-client<some number> section in the application's options that represents a POP account.

- In this section, set the value of the endpoint property to the name of the Endpoint to which e-mails should be redirected.

7. Configuring DNs. To connect DNs with SCXML applications for voice interactions, specify the following in the Annex of the DN:

Annex Section	Property	Equivalent Composer Block	Value	Notes
Orchestration	application	-	script:<name of the Enhanced Routing object to which interactions from this queue should be submitted>	Connects a DN to an Enhanced Routing object

- For more details, see the chapter on configuring Orchestration Server in the Orchestration Server 8.1 Deployment Guide.

Deploying Applications That Use Context Services

This topic discusses the following types of applications that use [Context Services](#):

- [SCXML Applications](#)
- [VXML Applications](#)

SCXML Applications

When you publish an [interaction processing diagram](#), Composer creates an enhanced Script record in the Configuration Database. This Script record has a `context_management_services_url` parameter, which is initialized with the UCS server parameters configured in [Context Services Preferences](#). When the SCXML application is run, this parameter is read to enable [Orchestration Server](#) to connect to Universal Contact Server (UCS). If you want to point to another UCS, you must either:

- Update the UCS parameters in the Context Services Preferences and re-publish, or
- Manually update the `context_management_services_url` parameter using either Configuration Manager or Genesys Administrator. The example below shows the configuration in Genesys Administrator.

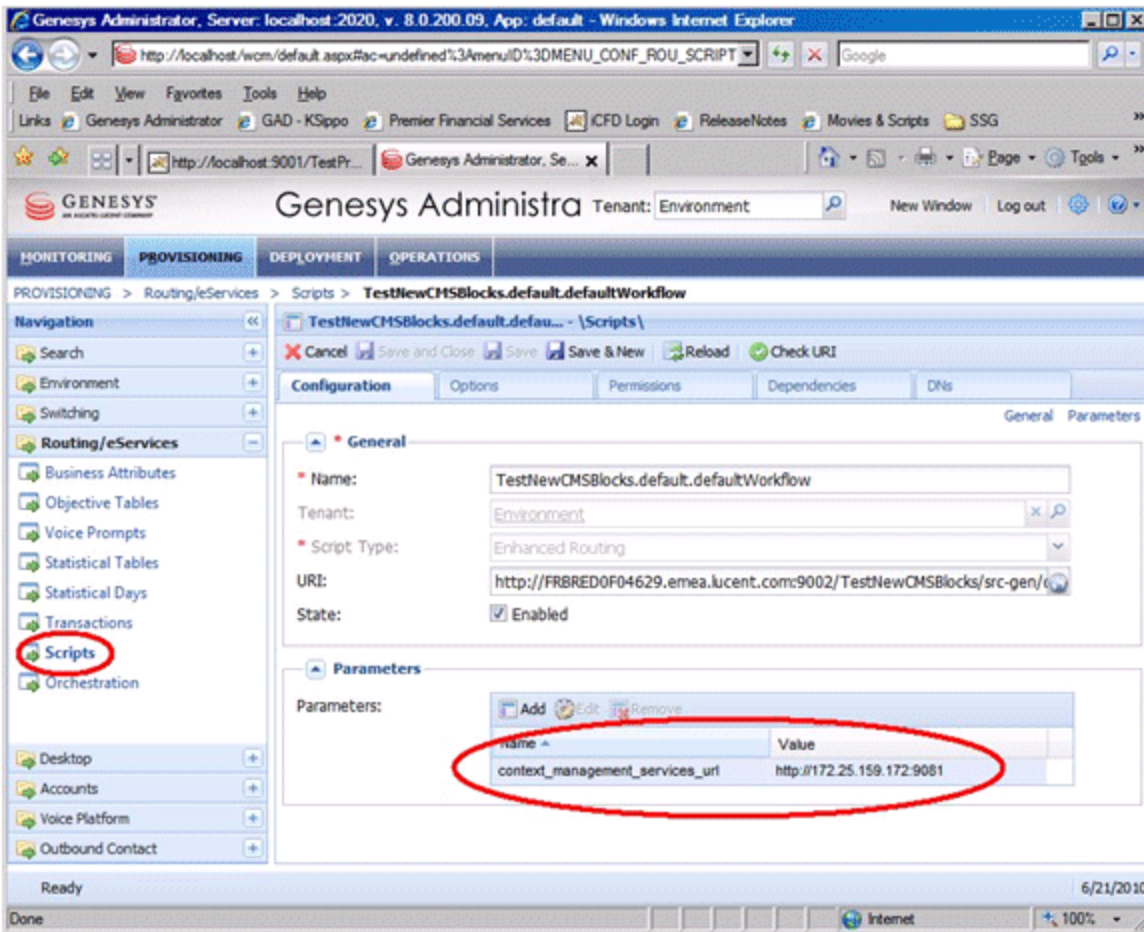

MoreImages/contextServicesurl.gif

VXML Applications

When running a callflow from a RM Direct call, you must update the IVRProfile to define an additional `context_services_url` parameter whose value points to the Context Services (UCS) URL.

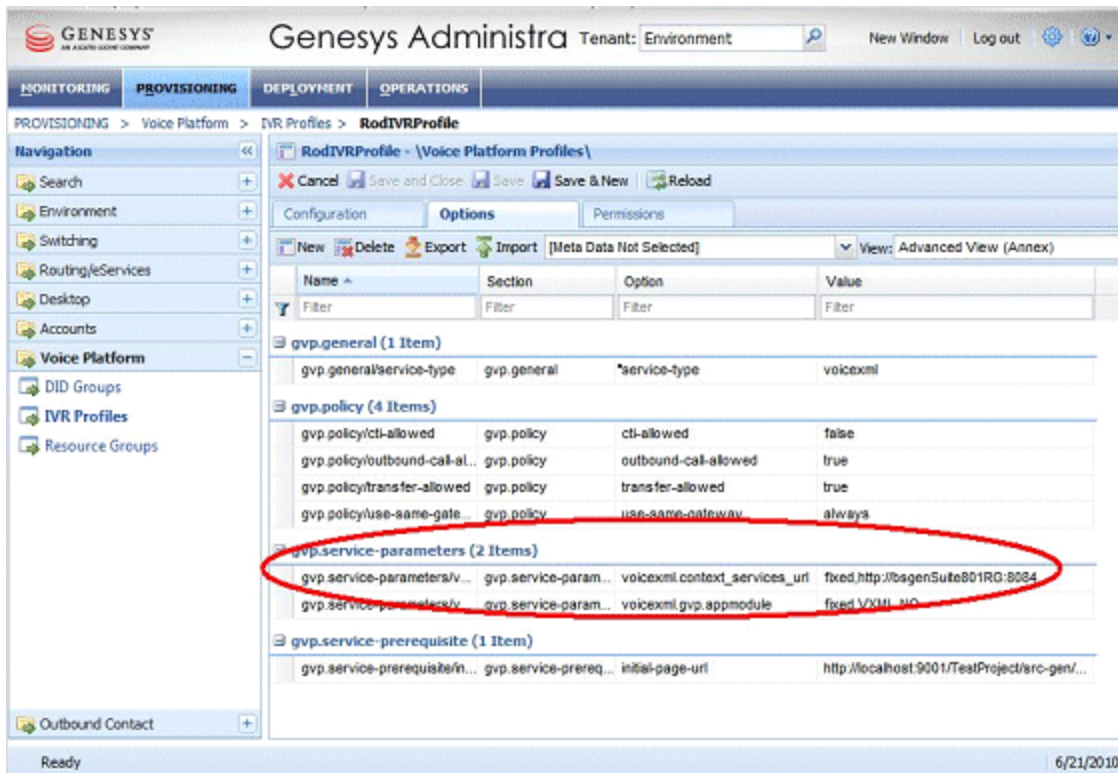

Running a Callflow from a PlayApplication Workflow Block In this case, you must configure the `context_services_url` parameter in RM's default IVR Profile, which RM passes on to the VXML application. Configuration details are as follows:

1. In the Sip Switch/DN/VOIP Services/MSML_Service DN (if the `msml-support` option is true in Sip Server) or in the standard VoipService DN (if the `msml-support` option is false in SipServer): change the option contact from `sip:host_MCP:port_MCP` to `sip:host_RM:port_RM`
2. In the Tenant object, designate a default profile for RM: `gvp.general` section, option `default-application=<name of some IVR Profile object under that tenant>`, Default Application for instance.
3. In the IVR Profile/Default Application specified above, in the Annex, add the section `gvp.service-parameters`.
4. In the `gvp.service-parameters` section, add the option `msml.context_services_url=` fixed,<http://demosrv8:908> (host:port of Context Management Server aka UCS' customer view port).
5. In the `gvp.service-parameters` section, add the option `voicexml.context_services_url=` fixed,<http://demosrv8:9080> (host:port of Context Management Server aka UCS customer view port).

Testing Your Application

After you have saved your files and generated code for your application, test the application as follows:

1. Deploy the project for testing.

- If deploying a Java Composer Project, Composer bundles Tomcat for running test applications, such as routing applications. If you [configured the Tomcat settings](#) prior to creating your Project, it will be auto-deployed on the Tomcat Server. You can double check this by clicking on the name of the Project in the Project Explorer, then right-click and select **Project Properties**. Select the Tomcat deployment category and verify that the project is deployed. If not, click **Deploy**.

Note: If deploying a .NET Composer Project, deploy your project on an IIS Server. Be sure you have [configured the IIS settings](#). Click on the name of the Project in the Project Explorer, then right-click and select **Project Properties**. Select the IIS deployment category and verify that the Project is deployed. If not, click **Deploy**.

2. For Voice Projects, use Run mode to run the application by selecting **Run > Run As > Run Callflow**, or by right-clicking on the callflow file name in the Project Explorer and selecting **Run As > Run Callflow**. The code is generated in the src-gen folder and the debugger sends the call to your SIP Phone.
3. Accept the call and you will be connected to the application on GVP. The call traces will become visible in the Call Trace window, and you should hear the voice application run.

Deploying Updates

This topic summarizes how to deploy updates to a Composer GVP voice application. For example, you may wish to deploy an updated version of a voice application with some new prompts and different DNIS numbers, but want to test it while the old one is still running. To deploy a new version of a Project without affecting the previously deployed one, try the following:

1. Export the existing Project (doesn't have to be a new Project unless it is needed in cases where SCM tools are not used).
2. Rename the .war file before deploying to the application server. The deployed URL will depend on this war file name and therefore result in a different URL for the updated Project. You can control the display name of the application from the export wizard, however, this does not affect the URL.

Notes:

- The above procedure works on Tomcat, but has not been tested on other application servers.
- if the .war file is renamed before deploying to the application server, the application URL will reflect the .war file name instead of the Project name. This behavior may be application server-specific. The URL will look like:

```
[http:// http://]<ip_of_application_server>:<port>/<war_file_name>/src-gen/<callflow_name>.vxml
```

- See the information on specifying the URL in [Exporting a Java Composer Project](#) above.
- Direct deployment to remote application servers is currently not supported in Composer.

Deploying Multiple Projects Using Bulk Manager

A new wizard, Composer Bulk Manager, is introduced in version 8.1.450.33 to manage bulk deployment of projects.

- Click the **Launch Bulk Manager** icon on the toolbar. The Composer Bulk Manager is displayed listing the Java and .NET projects available in the workspace, and their deployment status.



- To deploy multiple projects, select the required projects and click the **Deploy** button. The selected projects are deployed and the status in the **Deployment** column is changed to *Deployed*.
- To undeploy multiple projects, select the required projects that have been deployed and click the **UnDeploy** button. The selected projects are undeployed and the status in the **Deployment** column is changed to *Not Deployed*.

Important

Both Java and .NET projects can be deployed in conjunction into their respective configured server locations using the Composer Bulk Manager wizard. You must launch the Composer application using the **Run as Administrator** option to be able to view the deployment status for .NET projects.

Upgrading Multiple Projects Using Bulk Manager

Beginning with release 8.1.500.03, when you upgrade to a new version of Composer, you can use the Bulk Manager to upgrade multiple projects at one go. When you initially open Bulk Manager after upgrading to a new version, the status of the existing projects in the **IsUpToDate** column is displayed as *No*.



To upgrade multiple projects, select the required projects and click the **Upgrade** button. The selected projects are upgraded and the status in the **IsUpToDate** column is changed to *Yes*. When the

upgrade fails for a particular project, the status is displayed as *Unknown* or *Failed*. The version number in the **Version** column reflects the latest version for upgraded projects.

Important

You can also configure log levels for server-side blocks using the Bulk Manager. For more information, see [Configuring Log Levels for Server-Side Blocks](#).

Launching Bulk Manager on Composer Startup

Beginning with release 8.1.510.12, Bulk Manager is launched on starting the Composer application. This behavior is controlled through the **Launch Bulk Manager on Composer startup** option under **Window > Preferences > Composer**, and is enabled by default.

To prevent the Bulk Manager from launching automatically on Composer startup, deselect the **Launch Bulk Manager on Composer startup** option.

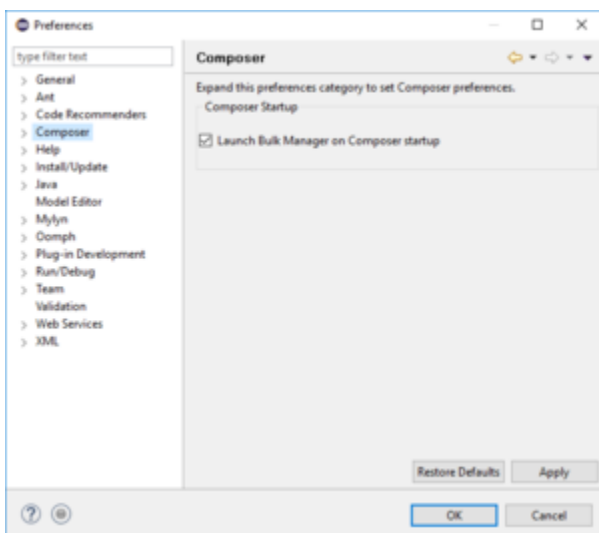

Important

Bulk Manager is launched asynchronously if the **Launch Bulk Manager on Composer startup** option is enabled.

Best Practices

This section discusses the best practices to use when developing efficient Composer applications. It contains the following topics: Also see:

- [Deploying Update](#).
- Best Practices in the *GVP 8.1 VoiceXML Reference Help* available within Composer (**Help > Help Contents**).

Pooling Reusable Subflows

This topic discusses how to share a pool of reusable subcallflows between multiple Composer Projects.

- **Note:** Accessing other system resources (include/jsp) across Projects is not supported.

Runtime Solution

You can have the shared pool exist in a single Project, which contains the set of subcallflows that is the shared pool. Each Project that wants to use these subcallflows uses the **Subdialog block**. The **Uri property** can be used to specify the location of the subcallflow VXML, which is deployed on an application server. For example, you could enter something like `http://appserver/SharedModules/src-gen/SubFlow1.vxml` in the URI field of the Subdialog block (or have the value contained in a variable). This solution works best if you want to keep a shared pool of subroutines at runtime. If you update a subroutine at the shared location on the application server, all applications that reference it immediately start using the updated subroutine.

Design Time Solution

If you need shared subroutines at design time, but want to include a copy in each application and avoid a global update to all deployed applications, you could try the following:

1. Identify a folder where shared subroutines will be stored. This can be inside a Project or a folder outside your workspace on your hard drive.
2. In any Project that needs to reference subroutines, create a new folder and link it to this shared subroutines folder. This will allow access to all shared subroutines in the referencing Project as if they are a part of the Project. Any changes made to these subroutines will update the master copy and propagate to all other Projects.
3. When you generate code and export a .war file, subroutine code will be included in the export allowing a more controlled deployment of shared subroutines. The drawback of this approach is that you will need to update each application individually.

You can also use an SCM tool to create these linked folders, which may allow other features, such as providing read-only access to shared subroutines from referencing Projects.

Multiple Developer Access to Single Project

At times, you may need to have more than one Developer working on different modules of the same Composer Project. For example, you could have a "modularized" Composer application with each module being its own **Subdialog**/Subcallflow. In this case, you could have the Composer workspace on a shared network drive with multiple workstations accessing the Project without corrupting the Project metadata. In a such a team development scenario, Genesys recommends using a source code management system. **Third party plugins** specific to the source control system (ClearCase, Subversion, Subclipse Team Plugin, and so on) can be installed on top of Composer to enable this functionality. The application files need to be structured to allow individual developers to work on different diagrams. Note: Merging updates to the same diagram from different sources has not been tested so currently Genesys recommends not doing that. If a source code control system is not an option, a shared location could possibly be used simultaneously by more than one developer, but this has also not been tested. The Project could remain on the shared drive and imported into the workspace on each developer's machine. The import is initiated from **File > Import > General > Existing Projects into Workspace**. Uncheck the option **Copy Projects into Workspace** so that files remain on the shared drive but can be used from the workspace.

Dynamic Web Projects

After you install Java EE Developer Tools plugins, you can create a Dynamic Web Project containing pages with active content. Unlike with static Web Projects, dynamic Web Projects enable you to create resources such as JavaServer Pages and servlets. Here's how to get started:

1. **Composer Help >> Install New Software.**
2. Click **Add**. In the resulting box, enter <http://download.eclipse.org/releases/galileo/>
3. Select it to see the available package.
4. Select the **Web, XML, and Java EE Development Eclipse Java EE Developer Tools** entry.
5. Install the plugins.
6. Restart Composer.
7. Create a Dynamic Web Project.

Note: Other missing project types can be similarly enabled.

Troubleshooting

For more extensive troubleshooting information for Genesys Voice Platform 8.1 components, please refer to the *Genesys Voice Platform 8.1 Troubleshooting Guide*.

The present troubleshooting section considers issues specific to Composer.

- [General Troubleshooting](#)
- [Block Names and Multi-byte Characters](#)
- [Bundled Help contents are always in English](#)
- [Chat Messages in Queues](#)
- [Checkin Error Source Code Integration](#)
- [Composer Project Not Deployed on Tomcat](#)
- [Composer Project Not Currently Deployed](#)
- [Connection Profile and ASCII Characters](#)
- [Chinese Characters Do Not Display](#)
- [Connection to a database fails](#)
- [Context Services URL Message](#)
- [CTI Block issues](#)
- [Debugging Failure](#)
- [Deployment Failure on IIS](#)
- [DotNET Project Issues](#)
- [Failed to Deploy Message](#)
- [Installation and Uninstallation](#)
- [JSON objects and JavaScript keywords](#)
- [ORS Compile Errors Non Esc Characters](#)
- [Plugin Installation](#)
- [Proxy Configurations .NET Composer Projects](#)
- [Request.Form Error Message](#)
- [SCXML Editor Element Not Bound Message](#)
- [Server-Side Troubleshooting](#)
- [Slow Response Time](#)
- [Stored Procedure Helper and DB Data Block](#)
- [Tomcat Service Failed to Start](#)
- [Test Calls Do Not Work](#)

- [Upgrade Error Message](#)
- [Validation Error upon publishing IPD](#)
- [Web Service Block Issues](#)
- [Workflow Does not Compile](#)
- [Workspace in Use or Cannot be Created](#)
- [Workspace Files Not in Sync](#)
- [Tomcat Service - File Permissions Issue](#)

General Troubleshooting

If you encounter any of the following symptoms, try increasing the memory allocated to Composer:

- You get OutOfMemory Exceptions
- The perspective layout changes on its own
- The system hangs while loading a Composer Project
- The Composer UI appears slow to respond

Edit the Eclipse.ini file present in the Eclipse installation folder. Open it in a text editor. It will look like this:

```
-startup
plugins/org.eclipse.equinox.launcher_1.3.100.v20150511-1540.jar
--launcher.library
plugins/org.eclipse.equinox.launcher.win32.win32.x86_64_1.1.300.v20150602-1417
-product
org.eclipse.epp.package.committers.product
--launcher.defaultAction
openFile
--launcher.XXMaxPermSize
256M
-showsplash
org.eclipse.platform
--launcher.XXMaxPermSize
256m
--launcher.defaultAction
openFile
--launcher.appendVmargs
-vmargs
-Dosgi.requiredJavaVersion=1.7
-Xms256m
-Xmx256m
```

Try increasing the value of XX:MaxPermSize> and Xmx to a higher value, for example, 512m.

Important

For more information on increasing heap size available to Eclipse, refer to the [increasing heap size](#) topic on the Eclipse website.

Block Names & Multi-byte Characters

Composer block names can contain only alphanumeric characters. If multiple-byte characters are used in block names, the code generation step fails and no SCXML or VXML file is generated from the Composer diagram.

Bundled Help contents are always in English

Chat Messages in Queues

When a chat server terminates unexpectedly or the server goes offline, the chats that were hosted on that chat server are terminated at the client end. However the chats remain in the system and continue to route to Workspace Desktop Edition (previously Interaction Workspace (IWS)).

IWS presents the chat, but displays a message that it cannot connect to the chat server.

When the agent can eventually mark the chat as done, IWS closes the chat in the agent IWS session, but it routes again, landing on any available agent IWS. This can occur for up to an hour.

The following is an example log entry:

```
14-03-28 12:17:10.138 [ChannelDefault] WARN ESDK - Channel tcp://ctizgesmipr002:4125/ closed
14-03-28 12:17:10.139 [ChannelDefault] WARN ESDK - Channel closing [Name]
ChatSessionChannel.Id001_90f30c5c-63c4-438b-a1b7-72c2dd7a8fc9 [Uri]
tcp://ctizgesmipr002:4125/
has 1 requests pending. They are lost
14-03-28 12:17:10.139 [ChannelDefault] DEBUG ESDK - Chat strategy 'ResyncStrategy' Processing
msg [Name] undefined <check channel evenr> [EndPoint] tcp://ctizgesmipr002:4125/
14-03-28 12:17:10.141 [ChannelDefault] DEBUG ESDK - Chat strategy 'ResyncStrategy' Found 1
related channel for Event undefined <check channel event>
14-03-28 12:17:10.147 [ChannelDefault] WARN edia.InteractionChat - Protocol Closed
message: 'Genesyslab.Platform.Commons.Protocols.ProtocolException: Exception occurred during
channel opening ---> System.Net.Sockets.SocketException: No connection could be made because
the target
machine actively refused it 172.203.217.149:4125
    at System.Net.Sockets.Socket.EndConnect(IAsyncResult asyncResult)
    at Genesyslab.Platform.Commons.Connection.CommonConnection.AsyncConnect(IAsyncResult res)
    - End of inner exception stack trace ---' Previous Channel State:'Opening,
[InteractionChat: Id001/0006Ka9HFHRR0T2B]'
```

Resolution

Use the workflow diagram to stop chat interactions from being routed to an agent. The workflow must determine if a chat session is still accessible before sending the interaction to an agent. One of the possible solutions could be to use "dummy" chat ESP messages. If such a message could not be delivered to Chat Server (see below details about errors), this will indicate not to route the interaction to the agent (and so the interaction could be stopped in workflow). The workflow could make several attempts (in the case where chat High Availability mode will be enabled) before finally stopping the attempt to route.

In order to hide these dummy messages from chat parties, the following could be done:

1. Use some special keywords in the message and modify the web chat application not to show those to the customer. Agent still will be seeing them.
2. Use the "Visibility" parameter of the chat ESP message request. It could have values ALL (default), INT (only agents) or VIP (only supervisors). Setting Visibility=VIP will hide the message from customer and agent (only supervisor will see those and it will be saved in final transcript in Universal Contact Server).

Errors (in the Interaction Server log) when trying to deliver chat ESP message are as follows:

If ChatServer is not running (was not restarted)

```
00:04:08.485 Trc 24112 Cannot find appropriate 3rd-party server: name: [any], type: ChatServer
00:04:08.485 Trc 24102 Sending to Universal Routing Server: URServer: 'EventError' (52)
message:
...
        AttributeErrorCode [int] = 1
        AttributeErrorMessage [str] = "Not found by type"
...
```

After ChatServer was restarted and running

```
00:18:32.532 Trc 26015 Received message 'ExternalServiceFault' ('502') from client
'ChatServer' -
Third party server:0:920, message attributes:
  attr_envelope [list, size (unpacked)=488] =
    'Parameters' [list] = (size=80)
      'FaultCode' [str] = "100"
      'FaultString' [str] = "interaction with specified id was not found"
      'Service' [str] = "Chat"
      'Method' [str] = "Message"
```

Checkin Error During Source Code Integration

If you are using Source Control tools, checking in Composer Projects contents after the Project Upgrade process may result in an error. To solve errors during checkin, refer to the table below and delete the listed files manually in the Source Control.

Composer From Version	Composer To Version	.NET Project, Files/Directories to Delete in Source Control	.Java Project Files/Directories to Delete in Source Control	File Location in the Project
8.0.30*	8.0.40*		lib	.
PlayBuiltinType.js	PlayBuiltinType.js	.\Resources\Prompts\en-US		
8.0.40*	8.1.00*	getWebRequestDataWorkflow.aspx	getWebRequestDataWorkflow.jsp	
		CVDBCommand.cs		.\App_Code
		BackEndLogic.cs		.\App_Code
		CVDBConnProfile.cs		.\App_Code
		dbrequest.cs		.\App_Code
		WebSvcClient.cs		.\App_Code
		SPHelper.cs		.\App_Code
		CVDBQueryFile.cs		.\App_Code
		upgradeReports		.\App_Code
8.1.00*	8.1.10*			

Composer Project Not Deployed on Tomcat

In the Project Settings, if you try to deploy the Project and it fails each time, check the following:

1. Are the Tomcat preferences configured correctly?
 - Make sure the [post-installation configuration](#) steps have been accomplished. Verify the Tomcat port, user name, and password values.
2. Is the Tomcat service running?

Open **Control Panel > Administrative Tools > Services**, and look to see if the ComposerTomcat service is listed as Started.

If not, follow the steps in [TomcatServiceFailedtoStart](#) to verify that no port clash is present.

Composer Project Not Currently Deployed

If you attempt to run a callflow or workflow and receive a message indicating the following:

```
Could not start the debug target. The Composer Project containing <diagram> is not currently deployed.
```

this indicates that the Project is not currently deployed. This most likely has occurred because the Project was either imported or renamed.

Do the following to deploy a Java Composer Project on Tomcat:

1. From the Project Explorer, right-click on the Composer Project and select **Properties**.
2. Select **Tomcat Deployment** and click the **Deploy** button.

Do the following to deploy a .NET Composer Project on IIS:

1. From the Project Explorer, right-click on the Composer Project and select **Properties**.
2. Select **IIS Deployment** and click the **Deploy** button.

Connection Profile and ASCII Characters

Database Connection Profiles do not support non-ASCII characters. Use only ASCII characters when creating connection profiles.

Chinese Characters Do Not Display

If Chinese UTF-8 characters cannot be displayed/used in the GRXML/VXML editor, install files for East Asian languages in Windows.

1. Select **Start > Control Panel > Regional Settings**.
2. Select the **Languages** tab.
3. Select **Install files for East Asian languages**.
4. Windows installs the necessary files for Chinese characters to be displayed correctly in most applications including Composer.

Connection to a Database Fails

If your application or Composer is not able to connect to your database, you can:

- Check connection parameters in the Connection editor UI and verify they are correct.
- Verify that the database is up and running and accepting new connections.
- Check the error message that is stored in the Composer logs. It will contain the database-specific error message returned by the JDBC driver.
- For SQLServer, you can create a new ODBC connection to verify whether the information is correct. Access it from **Control Panel > Administrative Tools > Data Source (ODBC)**. Provide the same information that you provided in the connection and test the connection.
- For Oracle, run SQLPlus and try connecting to your database with the same information you provided in the Connection Profiles editor.

Oracle and .NET Composer Projects

While working with .NET Composer Projects and Oracle, you may get this error at runtime: Oracle client and networking components were not found. These components are supplied by Oracle Corporation and are part of the Oracle Version 7.3.3 or later client software installation. Provider is unable to function until these components are installed. If so, try the following steps:

1. Log on to Windows as a user with Administrator privileges.
2. Launch Windows Explorer from the Start Menu and navigate to the ORACLE_HOME folder. To find this value, look up this variable in your machine environment variables through **My Computer > Properties > Advanced > Environment Variables > System Variables**.
3. Right-click the ORACLE_HOME folder in Windows Explorer and select the **Properties** option from the drop down list. A Properties window appears.
4. Click the **Security** tab of the Properties window. Click the **Authenticated Users** item in the Name list (on Windows XP the Name list is called Group or user names).
5. Uncheck the **Read and Execute** box in the Permissions list under the Allow column (on Windows XP the Permissions list is called Permissions for Authenticated Users).
6. Recheck the **Read and Execute** box under the Allow column (this is the box you just unchecked).
7. Click the **Advanced** button and in the Permission Entries list make sure you see the Authenticated Users listed there with:

Permission = Read & Execute Apply To = This folder, subfolders and files If this is not the case, edit that line and make sure the **Apply onto dropdown** box is set to This folder, subfolders and files. This should already be set properly, but it is important to verify it.

1. Click the **OK** button until you close out all of the security properties windows. This may take a few seconds as permissions are applied.
2. Restart your computer to assure that these changes have taken effect.

3. Retest your application.

Additional Troubleshooting Steps

If dbrequest.aspx returns a 500 error (with ASP debugging enabled) and if the event viewer shows the following exception message: Failed to access IIS metabase try granting access using the following at the command line (sample version number): **Start > Run > C:\WINDOWS\Microsoft.NET\Framework\v2.0xyz\aspnet_regiis -i**

Context Services URL Message

```
session.connection.protocol.sip.requesturi['context_services_url']
```

If you get the above message when debugging VXML, you must update your IVRProfile to define the `context_services_url` parameter.

See [IPD RuntimeConfiguration](#) for details.

CTI Block Issues

Potential Issues are as follows:

1. A **CTI block** throws an `error.unsupported.send` exception:
 - Check if external messaging is enabled in MCP. CTI blocks use `<send>` and `<receive>` tags and these can be disabled in MCP configuration. Please refer to the *Genesys Voice Platform Deployment Guide*.
2. A CTI block throws an `error.com.genesyslab.composer.unsupported` exception:
 - Check that the CTI functionality your application is trying to use is supported in the scenario that is getting executed at runtime -- CTI via SIPServer or CTI via CTIConnector. Consult the [Working with CTI Applications](#) and [CTI Blocks](#) topics to see which features are supported in the two scenarios in each CTI block.

Debugging Failure

While debugging diagrams or code, if there is a error, check the following:

1. The Project is deployed on Tomcat or IIS.
2. Debugger preferences are setup correctly. Select **Window > Preferences > Composer > Debugging > GVP Debugger** and configure the **GVP Debugger**. Make sure the SIP phone IP address and MCP's IP address and ports are correct.
3. Delete any previous debug configurations by right-clicking the file > **Debug As > Debug Configurations**. Delete existing debug configurations for the file. A new one will be created when debugging is initiated.
4. In the Project Explorer, check that the debugging-results folder exists. If not, create the folder and try debugging again.
5. While creating a .NET Composer project, if a non-default location is selected, debugging workflows or callflows may fail. Workaround: Give read permissions to all files in the Project from Windows Explorer so that they are accessible to the Debugger.

Deployment Failure on IIS

In a .NET Composer Project, if you try to deploy the Composer Project and it fails each time, check the following:

1. Is IIS installed on the machine?
 - Make sure IIS is installed and running on the machine that is running Composer.
2. If running on IIS 7.5 and Windows 7, does the account used for login have full administrative permissions? If not, the deployment will fail to access metadata with error: location IIS://LocalHost/w3svc Failed. This error appears either in the logs when you try to debug or in the **Project Properties > IIS Deployment** tab. Ensuring full administrative permissions is best accomplished by using one of two methods:
 - Log into your computer by using the local administrator account.
 - If logging in using an account with administrative permissions, but the account is not the local administrator account, open Composer by using the "Run as Administrator" option.
3. If running on IIS 7 (Windows Vista, Windows 2008) or IIS 7.5 (Windows 7), during the installation of IIS, IIS Metabase and IIS 6 configuration compatibility must be installed. See the section "Configuring in IIS Manager" in the Composer 8.1 Deployment Guide.
4. Are the IIS preferences configured correctly?
 - Make sure the **post-installation configuration** steps have been accomplished. Verify the IIS website port.
5. To address any potential deployment failures when using IIS, Genesys recommends disabling the User Account Control (UAC) for all Composer supported Windows operating systems (**Control Panel -> User Accounts -> Use User Account Control**).
6. Make sure IIS does not have any existing virtual directory of the .NET Composer Project name in the website where you want to deploy to.
7. Make sure the files in the Composer Project have read permissions for all users. The permissions can be set by navigating to the Project in Windows Explorer and using the Security tab in the Properties dialog of the folder.

DOTNet (.NET) Project Issues

This section contains information on issues that may arise when working with .NET Projects.

Microsoft Web Services Enhancements (WSE) Not Installed

For Composer versions prior to 8.1.420.14, use the steps below to work with Composer .NET Projects when the machine does not have WSE 3.0 installed:

1. Create a dummy file named `Microsoft.Web.Services3.dll` in any location.
2. Open Composer.
3. Go to **Window>Preferences>Composer>IIS/.NET**.
4. Click **Browse** for the **Microsoft WSE 3.0 Installed Path** option.
5. Navigate to dummy `Microsoft.Web.Service3.dll` file location and select it.

Composer will now allow you to create a .NET Project with few errors in the `getWebServiceData.jsp` page, which only affects the Web Services block.

Backend Page Requests Failing

If requests to backend pages in a .NET Composer Project are failing, it may be due to IIS validation. IIS validates all requests for security reasons.

- It is possible to disable validation. You can do this for a specific page by adding the following directive in the ASPX file: `<%@ Page validateRequest="false" %>`
- You can also disable validation for the entire Project by adding this configuration to the `web.config` file:
`<configuration> <system.web> <pages validateRequest="false" /> </system.web> </configuration>` Note that request validation is a security feature provided by ASP. Disabling it is at your own risk. See for details.

Error 500.24 - Internal Server Error

If you are using IIS 7 or IIS 7.5 with Integrated Pipeline Mode, requests to backend pages in a .NET Composer Project may fail with 500.24 Internal Server Error. This occurs because ASP.NET Integrated mode is unable to impersonate the request identity in the pipeline stages.

It is possible to ignore or workaround the 500.24 error.

- If your application does not rely on impersonation, edit the predefined web.config file within the DotNet Composer Project to set impersonate to false, <system.web> <identity impersonate="false"/>
- If your application relies on impersonation, configure Impersonate in IIS 7 as suggested in this link. [http://technet.microsoft.com/en-us/library/cc730708\(v=WS.10\).aspx](http://technet.microsoft.com/en-us/library/cc730708(v=WS.10).aspx)
- If you want to ignore these errors edit the predefined web.config file to set ValidateIntegratedModeConfiguration property to false. [http://msdn.microsoft.com/en-us/library/bb422433\(v=vs.90\).aspx](http://msdn.microsoft.com/en-us/library/bb422433(v=vs.90).aspx)[http://msdn.microsoft.com/en-us/library/aa965174\(v=vs.90\).aspx](http://msdn.microsoft.com/en-us/library/aa965174(v=vs.90).aspx)
- If you want to use the Composer predefined web.config file without making any new changes, set the Request-Processing mode of the Application pool to classic in your IIS. [http://technet.microsoft.com/en-us/library/cc725564\(v=ws.10\).aspx](http://technet.microsoft.com/en-us/library/cc725564(v=ws.10).aspx)

Failed to Deploy Message

The message below appears if trying to deploy a project and Tomcat is down or there is no connection to Tomcat. Check Tomcat preferences and start the service.

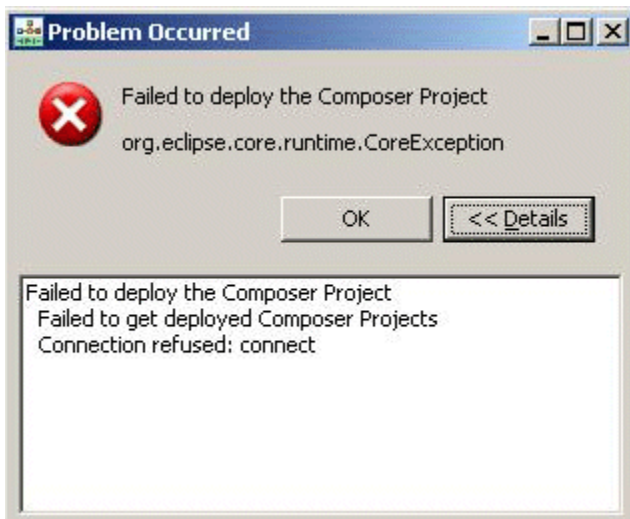

Installation and Uninstallation

When installing or uninstalling Composer in a Windows XP Professional or Windows Server 2003 Standard Edition environment, the prompt reboot may appear. After the reboot, the following message appears: There are some pending operations and the system needs a reboot. The target computer does not meet some mandatory requirements. Subsequent reboots result in the same behavior and you cannot install Composer on this machine. This is a result of pending reboots from other installations. To correct this situation:

1. Open the Registry editor.
2. Remove the following key: HKEY_LOCAL_MACHINE\SYSTEM\CurrentControlSet\Control\Session Manager\PendingFileRenameOperations
3. Install Composer.

JSON objects and JavaScript keywords

If the JSON Objects used within the VXML document contain JavaScript reserved keywords (for example: double), NGI will throw an error.semantic exception.

For example, if the following occurs:

```
{'double': {'content': '40.015', 'XMLNS': 'HTTP://WWW.WEBSERVICEX.NET/'}}
```

then accessing double.content in the above JSON Object will result in the following error:

```
exec_error SyntaxError: missing name after . operator JSOType.double.toSource()  
event error.semantic:1
```

Therefore, responses from the requested URLs in [Web Service](#) and [Web Request](#) blocks should not contain any JavaScript reserved keywords.

ORS Compile Errors & Non-Escaped Characters

The condition expression for event-related properties in interaction process (IPD) and workflow diagrams are not XML-escaped when generating the SCXML code. Non-escaped XML special characters in the condition expression field will cause **Orchestration Server** compile errors at runtime. As a result, the following XML special characters in condition expressions should be escaped:

CHARACTER	REPLACEMENT
"	"
<	<
>	>
&	&

For an existing 8.1.3 or 8.1.4 diagram:

1. Go to the IPD diagram Events property or workflow diagram block Exceptions property. In the case of an IPD, when you select the IPD in the Project Explorer, a Properties view shows the Events property.
2. Check for XML special characters in the Condition expression field and escape them as shown in the list above. If the Body field SCXML expression includes some conditions (i.e. <if cond="somecondition">), the condition expression needs to be XML-escaped as well.
3. Save the diagram and generate code.

Note: Condition expressions provided by Composer (like for default IPD event handlers) are already XML-encoded.

Plugin Installation

When installing plugins into Composer, you may have to add an **update site** to Composer's installation preferences.

1. Go to **Window > Preferences**.
2. Select **Install/Update > Available Software Sites**.
3. Ensure that the Galileo Eclipse Version update site is present
4. If the version update site is not present, add it. The URL for the location is:

[http://download.eclipse.org/releases/\\$EclipseVersionName\\$](http://download.eclipse.org/releases/$EclipseVersionName$) where EclipseVersionName is galileo, juno, kepler, and so on).

Proxy Configurations .NET Composer Projects

See [Proxy Settings](#) in the *Composer 8.1.4 Deployment Guide*.

Request Form Error Message

When running a .NET project, you may encounter the error message: A potentially dangerous Request.Form value was detected from the client .NET has a built-in security check that will reject values that look like a potential attack. You can disable the validation using the configuration described in this page: <http://www.asp.net/learn/whitepapers/request-validation>.

SCXML Editor Element Not Bound Message

The SCXML editor may show element not bound errors for an SCXML tag while editing a generated workflow or sub-workflow SCXML file. This is caused by missing namespace declarations in the root <scxml> element of the page. For workflow and sub-workflow-generated SCXML files, this error can be safely ignored as namespace declarations for the enclosing IPD SCXML file will take effect at runtime and the current page's <scxml> element will be ignored by ORS.

```

<!-- This is the CreateSMS1 State -->
<state id="CreateSMS1" initial="$$_MY_PREFIX_$$_CreateSMS1_CreateMessage">
  <state id="CreateSMS1_CreateMessage">
    <onentry>
      <log expr="_sessionid + ': Inside CreateSMS Block: CreateSMS1'"/>
      <assign location="App_CreateSMS1['ixnId']" expr="'undefined'"/>
      <script>
        var App_CreateSMS1_Pending_Events = 2;
      </script>
      <ixn:createmessage requestid="App_CreateSMS1['requestid']"
        media="_genesys.ixn.mediaType.TMediaNativeSMS"
        server="'SMSServer'"
        queue="'OutputQueue2'"
        type="outbound_new"
        msgsrc="'*****HELLO!*****'"
        from="sourceaddress"
        to="destianationaddress"

```

The prefix "ixn" for element "ixn:createmessage" is not bound.

```
</onentry>
```

```

<?xml version="1.0" encoding="utf-8"?>
<scxml version="1.0" xmlns="http://www.w3.org/2005/07/scxml"
  xmlns:xi="http://www.w3.org/2001/XInclude"
  initial='AppEntry'
  profile="ecmascript"
  name="createsms_detach">
  <!-- Auto Generated by Composer 8.1.100.92 -->
  <!-- Application Author: Version: 1.0 CreatedOn: -->

```

Server-Side Troubleshooting

The table below lists Server Side block troubleshooting situations and steps to remedy.

Situation	Block	Steps to Troubleshoot
I entered the Service URL but getting a pop-up with Check the Web Service URL	Web Service Block	<p>Verify that the WSDL definition is accessible in a web browser.</p> <p>Check the Composer logs for possible errors in fetching the WSDL. Location: <workspace>\.metadata Check that the WSDL definition is accessible and test with the Web Services Explorer utility as described in the Troubleshooting section.</p>
I entered the Service URL and I can choose the SOAP operations, but the parameters do not show up in the dialogs	Web Service Block	<p>Verify that the WSDL definition is accessible in a web browser.</p> <p>Check the Composer logs for possible errors in fetching the WSDL. More details can be found in the logs in the following location: <workspace>\.metadata\plugins\com.genesyslab.studio.model folder Check that the WSDL definition is accessible and test with the Web Services Explorer utility as described in the Troubleshooting section.</p>
Using the Web Services Explorer utility	Web Service Block	<p>The Web Services Explorer is a JSP Web application hosted on the Apache Tomcat servlet engine contained within Eclipse. The Web Services Explorer is provided with Composer and allows you to explore, import, and test WSDL documents.</p> <p>Check that the WSDL definition is accessible and test with the Web Services Explorer utility as described in the Troubleshooting section.</p>
Errors during runtime	<p>Web Service Block</p> <p>Web Request Block Backend Block</p>	<p>Check the Composer logs for possible errors in fetching the WSDL.</p> <p>Check the backend logs. For ASP.NET projects, check the IIS logs For Java Projects, check the Tomcat standard logs. Check that the WSDL definition is accessible and test with the Web Services Explorer utility as described in the Troubleshooting section.</p>
I copied my callflow/workflow from one project to another but my Backend block does not work	Backend Block	<p>Check that any custom backend libraries or applications have also been copied to the new project.</p>

Backend block		
---------------	--	--

Logs:

- Java Composer Projects Server Side Backend logging can be controlled using the `log4j.xml` file present in the `$ComposerInstalledLocation\tomcat\lib` folder.
- For DotNetComposer Projects `web.config` file can be used to control the Server Side logging.
- Java Composer Projects exported as WAR files will have the `log4j.xml` bundled inside the `WEB-INF\lib` folder. If the `log4j.xml` configuration format is not working, you can add a `log4j.properties` in the `tomcat/webapps/<application name>/WEB-INF/classes` folder.

Notes:

- Service URL has to end with `wsdl` or `WSDL`
- Cannot use `-` or other reserved characters in the Entry block for a variable value. Enter the value directly in the input parameters dialog by typing the value in the Expression column as a string; example: `'atm near 37.771008, -122.41175'`

Important

Tomcat is no longer bundled with Composer beginning with version 8.1.561.30. You will be prompted to provide the Tomcat installed location when running the Composer installer.

Slow Response Time

If Composer response time is slow, stop/disable anti-virus software that might be running on the system.

Stored Procedure Helper and DB Data Block

When **StoredProcedure** is selected for the **Query Type** in the DB Data block, you can open the **Stored Procedure Helper** dialog box.

If using the one of the database Project Templates, after selecting a stored procedure and clicking Execute, you may get a Problem Occurred exception message and a null exception may occur in the logs.

This may occur, for example, if the correct parameters are not passed.

Tomcat Service Failed to Start

Start Tomcat and **Stop Tomcat** toolbar buttons can be used to control the bundled Tomcat service from within the Integrated Development Environment. In some cases, using these buttons may display error messages.

```
Failure in Starting Tomcat Service. Composer Tomcat could not be started
```

```
Failure in Stopping Tomcat Service. Composer Tomcat could not be stopped
```

If you receive these error messages, close Eclipse (or Composer) and run Eclipse.exe (Composer.exe) as administrator by right clicking the file and selecting **Run as Administrator**. This provides administrator permission to the integrated development environment and enables it to start/stop the Tomcat service.

If the **Start Tomcat** button is clicked when the service is already started, this message is displayed:

```
Failure in starting Tomcat Service
Reason:
Tomcat Service could not be started.
Please check if Tomcat is already running.
```

Tomcat Windows Service

Composer bundles Tomcat and deploys it as a Windows Service called ComposerTomcat. If you receive a message indicating that the Tomcat Service failed to start, please check the following:

1. From **Control Panel > Administrative Tools > Services**, check to see if the ComposerTomcat service is started.
2. If the service is not started, open up the log files in `${ComposerInstalledPath}/tomcat/logs` and look for an error that looks like: `java.net.BindException: Address already in use: JVM_Bind`.
3. If you see this error, it means that the port specified in the Tomcat configuration screen in the installer wizard is already in use. Uninstall Composer and reinstall using a different value for the Tomcat port.

Another place to check is the `composer_global.properties` in the installed location `<program files/GCTI/Composer 8.1/>`. It should show the correct Tomcat port number e.g. `TOMCAT_PORT=8082`

Note: The port number for Tomcat entered during Composer installation and the port number in Composer preferences should match.

Test Calls Do Not Work

If the test calls from Composer keep failing, check the following:

1. Do you keep getting Received 200 OK without receiving debugging control info for every test call made from Composer?
 - Make sure that the `vxml.i.debug.enabled` parameter on the MCP is set to true. Follow the instructions in [Post-Installation Configuration](#) to verify the values.
2. Is the Tomcat service or IIS service running?
 - If you are using Tomcat, take the actions described in [TomcatServiceFailedtoStart](#). If no port conflict exists, try restarting Tomcat from Windows Services.
 - If you are using IIS, take the actions described in [DeploymentFailureonIIS](#). Try restarting IIS from Windows Services.
3. Has Debugger configuration been set as described in the Configure Tomcat and Debugger Settings cheat sheet, or has IIS been configured according to the Setting IIS Preferences cheat sheet?
 - Check the instructions in [Post-Installation Configuration](#).
4. Is there a SIP Phone running on the configured host and port number?
 - Check your installation for a SIP Phone, and check the SIP Phone values in [Post-Installation Configuration](#).
5. Can you make a test call directly from the SIP Phone?
 - If so, this confirms that the MCP and SIP Phone are working fine.
6. Is your SIP Phone running on the dedicated port?
 - If not, check your SIP Phone documentation to see how to configure it to run on a dedicated port. If the SIP Phone does not support this, switch to one of the SIP Phones like X-Lite which provides this capability.
7. Do you have a local firewall on the development server (for example, Windows Firewall on Windows XP/2003)?

Make sure that the following TCP ports have been opened:

- Tomcat port (this is generally set to port 8080). If you installed Tomcat on a different port, open its corresponding port in the firewall. IIS port (this is generally set to port 80). If you installed IIS on a different port, open its corresponding port in the firewall.
- UDP port on which your SIP Phone is running (by default this will be 5060 or 5070). Check your SIP Phone settings for the exact port number.
- RTP ports on which your SIP Phone will get the audio stream. Check your SIP Phone Help file

for details on this. Some SIP phones will auto-configure this during installation.

If you continue to run into problems with the firewall and calls are not successful, try turning off the firewall temporarily when making the test calls.

See [GVP Debugging Limitations](#).

Upgrade Errors and Error Messages

Diagram File Upgrades

Composer does not support upgrading diagram files from 8.0.4 versions to 8.1.2 or higher versions. If a diagram upgrade is required, first upgrade the Projects to 8.1.1 versions and then upgrade to 8.1.2 or higher versions.

Tomcat version mismatch errors

One or more of these errors may be observed:

- **Compilation errors in Eclipse console**

Errors seen on building the Composer Project.

```
[javac] warning: C:\Program Files (x86)\Sun\JRE\7u5\lib\rt.jar(java/net/
ProtocolException.class):
major version 51 is newer than 50, the highest major version supported by this compiler.
[javac] It is recommended that the compiler be upgraded.
[javac] warning: C:\Program Files (x86)\Sun\JRE\7u5\lib\rt.jar(javax/net/ssl/
KeyManager.class):
major version 51 is newer than 50, the highest major version supported by this compiler.
[javac] It is recommended that the compiler be upgraded.
[javac] Note: Some input files use or override a deprecated API.
[javac] Note: Recompile with -Xlint:deprecation for details.
[javac] Note: <your project path>\WEB-INF\src\org\apache\jsp\include\
getWebRequestData_jsp.java
uses unchecked or unsafe operations.
[javac] Note: Recompile with -Xlint:unchecked for details.
```

- **Tomcat logs**

```
Tomcat logs error:-
Tomcat localhost log file we get the following error:
15-mei-2014 15:04:17 org.apache.catalina.core.StandardWrapperValve invoke SEVERE:
Servlet.service() for servlet jsp threw exception
java.lang.UnsupportedClassVersionError: com/genesyslab/studio/backendlogic/db/
CVDBBackendHandler :
Unsupported major.minor version 51.0
at java.lang.ClassLoader.defineClass1(Native Method)
at java.lang.ClassLoader.defineClassCond(ClassLoader.java:632)
at java.lang.ClassLoader.defineClass(ClassLoader.java:616)
at java.security.SecureClassLoader.defineClass(SecureClassLoader.java:141) at
org.apache.catalina.loader.WebappClassLoader.findClassInternal(WebappClassLoader.java:1819)
at org.apache.catalina.loader.WebappClassLoader.findClass(WebappClassLoader.java:872)
at org.apache.catalina.loader.WebappClassLoader.loadClass(WebappClassLoader.java:1327)
at org.apache.catalina.loader.WebappClassLoader.loadClass(WebappClassLoader.java:1206)
at org.apache.jasper.servlet.JasperLoader.loadClass(JasperLoader.java:128)
at org.apache.jasper.servlet.JasperLoader.loadClass(JasperLoader.java:66)
```

Root Cause:

Composer 8.1.3 requires Tomcat with JVM 1.7 (please check system-level guide, *Genesys Supported Operating Environment Reference Guide*, for the most updated version information). This is required both

- At design time while working on your application in the Composer/Eclipse Integrated Development Environment.
- At runtime when the exported application is deployed on production or test servers where Composer is not installed.

Resolution:

1. Ensure Tomcat JAVA version is set to the correct version as mentioned above or as per the latest information in the *Composer Deployment Guide*.
2. Restart Composer Tomcat
3. Clean the Project in Composer from the Project menu.
4. Build the project.

Note: If you continue to see errors, please ensure that the JVM version set as the default in the operating system (JAVA_HOME) is the same as the version being used in Tomcat (check version from Tomcat scripts/utilities).

java version mismatch and unsupported class version errors

After upgrading to Composer 8.1.3 from prior versions, java version mismatch and unsupported class version errors may appear in the console window. For example:

```
15-mei-2014 15:04:17 org.apache.catalina.core.StandardWrapperValve invoke SEVERE:
Servlet.service()
for servlet jsp threw exception java.lang.UnsupportedClassVersionError:
com/genesyslab/studio/backendlogic/db/CVDBBackendHandler : Unsupported major.minor version
51.0
```

As a workaround, use the Composer workbench **Project Clean** to clean all the Projects. This will remove all the temporary jsp compiler-related files inside the WEB-INF folder files and do a new Composer Project build.

Validation Error upon publishing IPD

Sometimes, when publishing an IPD to the Config server for the first time, Composer shows a Validation Error. After a second publish, no error appears, and the publish completes successfully. The likely cause is that the Config Server does not like the data being written to it. Most likely the underlying SQL Server isn't configured to accept non-ascii input.

Web Service Block Issues

If you have problems using the [Web Service](#) block, follow the procedure below. Also see the [Errors in WSDL Parsing](#) section in the Web Service block topic.

Web Services Explorer

Before proceeding to the Web Service block, use the Web Services Explorer to run and test your Web Service.

- To access the Web Services Explorer from the diagram, right-click on the Web Service block and select Test with Web Services Explorer. The Web Services Explorer view will open and provide support for browsing and invoking Web services natively from the WSDL supplied in the Web Service block.

Setting Properties in the Web Service Block

When you provide the WSDL URL in the Service URL property, Composer will try to access the URL and parse it to populate the drop-down fields for the remaining properties. If the following error occurs, there is a problem in parsing the WSDL: An error occurred while parsing the WSDL url WSDLException: faultCode=OTHER_ERROR: Unable to resolve imported document at 'null'.

1. Verify that the WSDL URL entered is valid and prefixed with http://.
2. If you are behind a proxy server, configure the proxy settings by going to Window > Preferences, then expand General and select Network Connections.
3. Select Manual proxy configuration and add values for HTTP proxy and Port.
4. After you have chosen the available Service and operations which you want to invoke, set the required input Parameters, if any, in the Input Parameters dialog box.
5. You can use the Output Result dialog box to map the Web Service response keys in to AppState variables by setting the Map Output Values to Variables property to true; otherwise the entire Web Service response will be assigned to a variable.
6. If required, set the Web Service authentications (only basic authentication is supported).

Execution Errors when the Web Service Block is Executed in Your Call

If you see the error subdialog_return :|event|com.genesys.studio.webservice.badFetch in the call traces while executing the Web Service block, check the following:

1. If your Tomcat Web Server is behind a proxy server, configure Proxy settings in Tomcat.

Proxy settings have to be configured in Tomcat for the backend pages to access the Web when Web Request and Web Service blocks are used. To configure proxy settings in Tomcat, add the following lines into the catalina.properties file under the \$ComposerInstalledDir\tomcat\conf\ folder:

```
http.proxyHost=hostip http.proxyPort=portofProxy http.proxyUser=username  
http.proxyPassword=password
```

1. Finally, restart the **ComposerTomcat** service.
2. Use the Web Services Explorer to test whether the Web Service is a valid one.
3. Verify the Service URL and Service End Point values.
4. Verify that the supplied Input Parameters and the data type of the values are valid.
5. Verify whether the Web Service requires any basic authentications and if needed, configure these authentications in the Security category of the Web Service block.

How to Configure Connection Timeout and Read Timeout See [Connection and Read Timeout Configuration](#).

Custom SOAP Envelope Feature - Fetch Failed in Weblogic

Weblogic returns null for the `ServletContext.getRealPath()` method when web applications are deployed as WAR files. You must manually enable this in Weblogic since the Composer Custom SOAP Envelope property uses the `getRealPath()` method.

Here are the steps to enable RealPath in a Weblogic application server:

1. Go to the server admin console->**Domain**-> Web applications.
2. Click the check box for **Archived Real Path Enabled**. This should make an entry into the domain `config.xml` as below.

```
<web-app-container>  
<show-archived-real-path-enabled>true</show-archived-real-path-enabled>  
</web-app-container>
```

A second option is at the web application level by updating `weblogic.xml` as below:

```
<container-descriptor>  
<show-archived-real-path-enabled>true</show-archived-real-path-enabled>  
</container-descriptor>
```

The value of `<show-archived-real-path-enabled>` set in the web application has precedence over the value set at the domain level. The default value of this property is false.

Web Service Block Issues

If you have problems using the **Web Service** block, follow the procedure below. Also see the **Errors in WSDL Parsing** section in the Web Service block topic.

Web Services Explorer

Before proceeding to the Web Service block, use the Web Services Explorer to run and test your Web Service.

- To access the Web Services Explorer from the diagram, right-click on the Web Service block and select **Test with Web Services Explorer**. The Web Services Explorer view will open and provide support for browsing and invoking Web services natively from the WSDL supplied in the Web Service block.

Setting Properties in the Web Service Block

When you provide the WSDL URL in the Service URL property, Composer will try to access the URL and parse it to populate the drop-down fields for the remaining properties. If the following error occurs, there is a problem in parsing the WSDL: An error occurred while parsing the WSDL url WSDLException: faultCode=OTHER_ERROR: Unable to resolve imported document at 'null'.

1. Verify that the WSDL URL entered is valid and prefixed with http://.
2. If you are behind a proxy server, configure the proxy settings by going to Window > Preferences, then expand General and select Network Connections.
3. Select Manual proxy configuration and add values for HTTP proxy and Port.
4. After you have chosen the available Service and operations which you want to invoke, set the required input Parameters, if any, in the Input Parameters dialog box.
5. You can use the Output Result dialog box to map the Web Service response keys in to AppState variables by setting the Map Output Values to Variables property to true; otherwise the entire Web Service response will be assigned to a variable.
6. If required, set the Web Service authentications (only basic authentication is supported).

Execution Errors when the Web Service Block is Executed in Your Call

If you see the error subdialog_return :|event|com.genesys.studio.webservice.badFetch in the call traces while executing the Web Service block, check the following:

1. If your Tomcat Web Server is behind a proxy server, configure Proxy settings in Tomcat.

Proxy settings have to be configured in Tomcat for the backend pages to access the Web when Web Request and Web Service blocks are used. To configure proxy settings in Tomcat, add the following lines into the catalina.properties file under the \$ComposerInstalledDir\tomcat\conf\ folder:

```
http.proxyHost=hostip http.proxyPort=portofProxy http.proxyUser=username  
http.proxyPassword=password
```

1. Finally, restart the CV80Tomcat service.
2. Use the Web Services Explorer to test whether the Web Service is a valid one.
3. Verify the Service URL and Service End Point values.
4. Verify that the supplied Input Parameters and the data type of the values are valid.
5. Verify whether the Web Service requires any basic authentications and if needed, configure these authentications in the Security category of the Web Service block.

How to Configure Connection Timeout and Read Timeout

See [Connection and Read Timeout Configuration](#).

Runtime Error for Dot.NET Projects in Windows 2012

While using IIS 8, it must be installed with Microsoft.NET Framework 3.5 (see steps below).

Before running Server-Side blocks/Projects, ASPX and ASP MIME must be installed as IIS 8 does not have it pre-configured to avoid the following runtime error:

```
error.badfetch.http.405:1|HTTP error response 405
```

The steps to add IIS 8 with Microsoft .NET Framework 3.5 feature in Windows 8 and Windows 2012 are as follows:

1. Open Control Panel, Select **Programs and features**.
2. Select **Turn Windows Features on or off**. Server Manager will open.
3. In **Before You Begin** page, click **Next**.
4. In **Installation Type, Role-based or feature-based installation** is selected by default. Click **Next**.
5. In **Server Selection**, select the server for your installation from the server pool. Click **Next**.
6. In **Server Roles**, select **Web Server (IIS)**. Click **Next**.
7. In **Features**, select **.NET Frameworks 3.5 Features**. Click **Next**.
8. Under **Web Services Role (IIS), Role Services**, select features as required. Under **Application Development**: .NET Extensibility 3.5, .NET Extensibility 4.5, ASP.NET 3.5, ASP.NET 4.5 are necessary). Click **Next**.

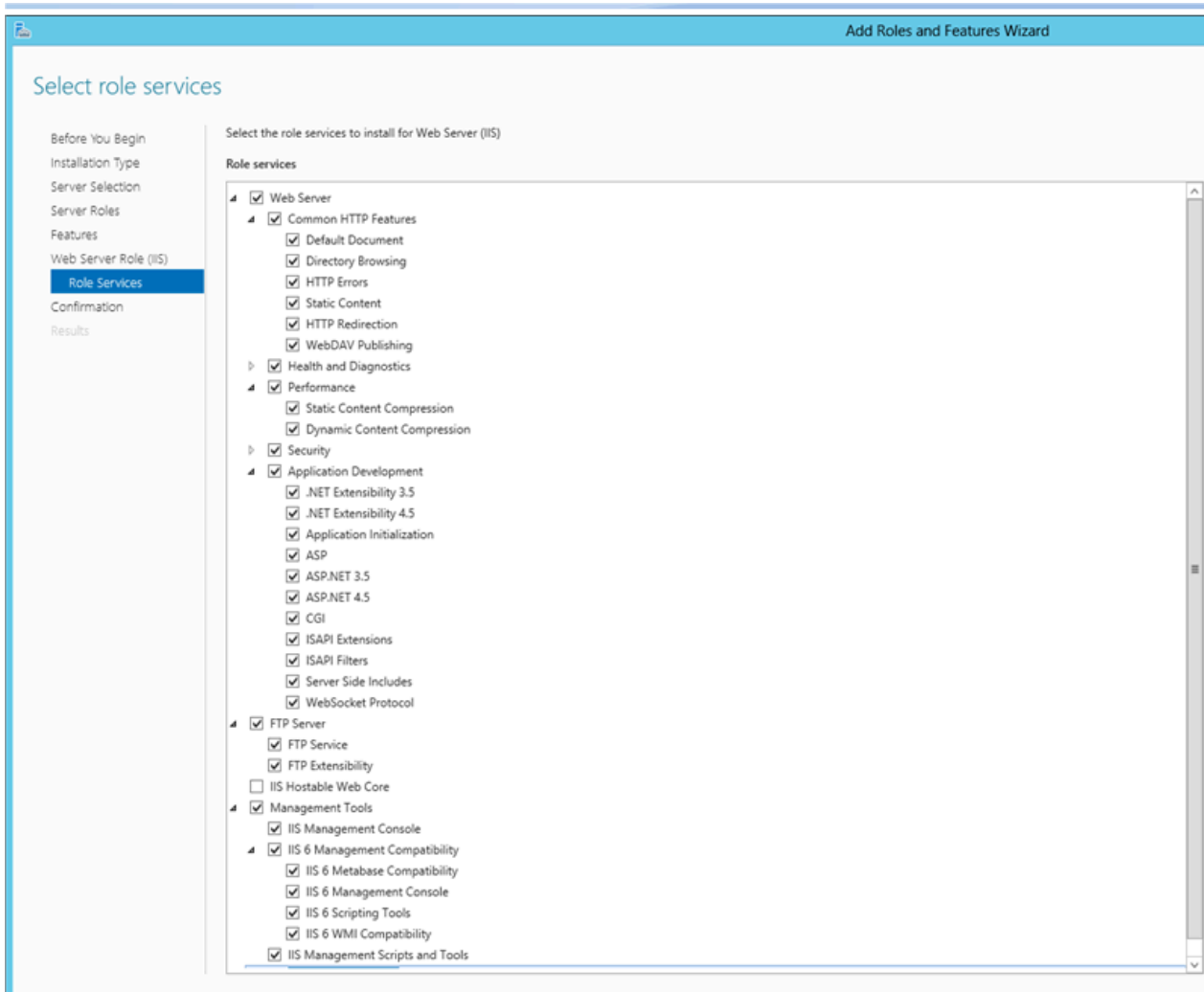

9. In **Confirmation**, click **Install**.
10. After IIS installation, open IIS manager as `inetmgr` from **Run as**.
11. Expand **Sites** and Select **Default Web Site**.
12. On the **Default Web Site Home** page select MIME Types.
13. Add MIME types as VXML, SCXML, ASP, ASPX as shown in the figures below.

Add MIME Type ? x

File name extension:

MIME type:

OK Cancel

Add MIME Type ? x

File name extension:

MIME type:

OK Cancel

Add MIME Type ? x

File name extension:

MIME type:

OK Cancel

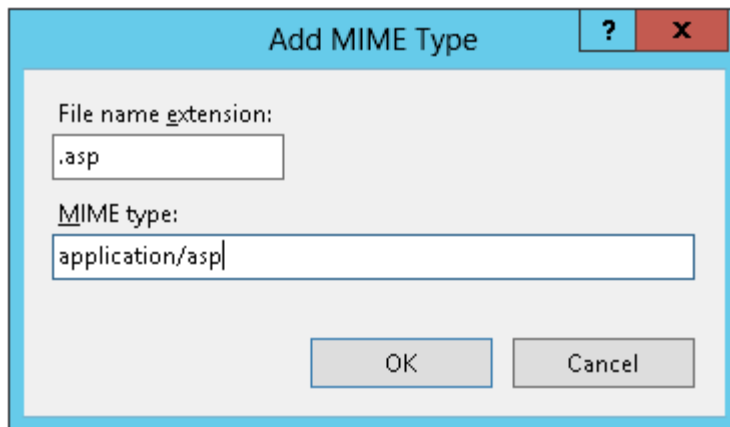

14. Restart the default website (**Default Website Home**).

Workflow Does Not Compile

If a routing application has been **deployed**, but **Orchestration Server (ORS)** is not compiling the **workflow**, consider the following:

- ORS can only run SCXML applications generated/specified in an **interaction process diagram (IPD)**.
- Typically, for voice applications, you create one or more IPD diagrams, plus one workflow diagram per strategy.
- IPD **Workflow** blocks, Resource property, refer to the workflow diagram(s).
- The EnhancedRoutingScript objects in the Configuration Database associated with the Routing Point must point to the IPD SCXML and not to the workflow SCXML.
- At runtime, the IPD SCXML will include the workflow SCXML.
- If an EnhancedRoutingScript object is associated with the workflow SCXML instead of the IPD, ORS places an error message in the log.

Workspace in Use or Cannot be Created

The above message may display if multiple Composer instances are sharing the same **workspace**, causing an access violation. Use a different workspace or ensure that only single instance of Composer accesses a workspace.

Workspace Files Not in Sync

When running into files in your Project that are out of sync, there is a Refresh automatically preferences option to avoid manually pressing F5 on the Workspace resource.

Refresh Automatically

To enable the preference:

1. Go to **Window > Preferences**.
2. Expand the **General** tree item and click on the **Workspace** item.
3. Mark the check box **Refresh automatically**.
4. Click **OK** to close the Preferences dialog.

To avoid refresh issues Composer recommends the following when dealing with Project resource files:

- Use the File > Import capability.
- Add directly from Windows Explorer and then refresh the resource list by pressing F5 in Composer's Project Explorer.
- Drag and drop files from the file system onto Composer's Project Explorer.

Tomcat Service - File Permissions Issue

The Tomcat 9 service does not have full permissions by default for logs and configuration folders. As a result, logs are not generated and deployments fail.

Workaround:

1. Stop the Composer Tomcat service.
2. Right-click the **Tomcat** folder within the Composer installer folder, and grant full permissions to the required user accounts in the **Security** tab.
3. Close the dialog and start the Tomcat service.

Links to Useful Resources

You may find information and resources at the following locations to be useful as you use Eclipse and Composer.

For Genesys Product Documentation

Each product has its own documentation for online viewing at the Genesys [Genesys Documentation website](#) or on the Documentation Library DVD, which is available from Genesys upon request.

- [Universal Routing Server](#) (URS)—which enables intelligent distribution of voice and multimedia interactions throughout the enterprise. You may need this link if transitioning from IRD routing strategies to Composer routing workflows.
- [Orchestration Server](#) (ORS)—an open standards-based platform with an SCXML engine, which enables the customer service process. See the *Orchestration Server Developer's Guide* for information on ORS Functional Modules and Extensions.

For Eclipse

- Eclipse website: <http://www.eclipse.org/>
- Ganymede Documentation: <http://help.eclipse.org/ganymede/index.jsp>
- Workbench User Guide: <http://help.eclipse.org/ganymede/nav/0>

For VXML

- VXML 2.1 Draft Specification: <http://www.w3.org/TR/voicexml21/>
- VoiceXML website: <http://www.voicexml.org>
- For information on the ECMAScript functions that can be used in Expression Builder: <http://www.ecma-international.org/publications/files/ECMA-ST/Ecma-262.pdf>.

For IBM WebSphere

- Installing WebSphere Application Server 6.1: http://publib.boulder.ibm.com/infocenter/wasinfo/v6r1/topic/com.ibm.websphere.express.doc/info/exp/ae/tins_custome_61.html
- Installing application files with the console: http://publib.boulder.ibm.com/infocenter/wasinfo/v6r1/index.jsp?topic=/com.ibm.websphere.express.iseries.doc/info/seriesexp/ae/trun_app_instwiz.html
- Configuring HTTP Proxy Information: http://publib.boulder.ibm.com/infocenter/wasinfo/v6r1/topic/com.ibm.websphere.express.doc/info/exp/ae/twbs_configaddhttppropertiesadmin.html

For Web Services

Web Services Description Language (WSDL) website: <http://www.w3.org/TR/wSDL>

SCXML Reference Documents

- State Chart XML (SCXML): State Machine Notation for Control Abstraction: <http://www.w3.org/TR/scxml/>
- ECMAScript Language Specification: <http://www.ecma-international.org/publications/files/ECMA-ST/Ecma-262.pdf>
- Standard ECMA-327: <http://www.ecma-international.org/publications/files/ECMA-ST/Ecma-327.pdf>

Composer Product Videos

This page contains Composer product videos. Stay tuned for more videos to come. To request a video, please email Techpubs.webadmin@genesyslab.com.

Composer Installation Video

Below is a video tutorial on [Composer 8.1.4 Installation](#). Depending on the flavor of Eclipse you have installed, your interface may appear slightly different than that shown in the video.

[Link to video](#)

Getting Started After Installation

This tutorial shows how to immediately get familiar with Composer by using a sample application.



Uninstalling Composer

This video tutorial shows how to uninstall Composer when you want to install a later version.

[Link to video](#)

Moving to Composer from IRD

A video on using Composer to create routing strategies instead of IRD and the similarities between the two.

[Link to video](#)

Introduction to the Interface

Below is a video that can function as a brief introduction to the Composer user interface.

[Link to video](#)

Using Templates to Create a Routing Workflow

Below is a video tutorial on using Composer templates to create a workflow that routes interactions to targets based on a percent allocation.

[Link to video](#)

Integrated Voice and Route Application

This video shows an example workflow that integrates GVP voice self-service with Orchestration routing.

[Link to video](#)

Defining Agents, Agent Groups, and Skills

This video shows how Agent, Agent Group, and Skill objects are defined in [Genesys Administrator](#) prior to using them for skills-based routing in Composer.

[Link to video](#)

Skills-Based Routing

This video presents a simple example of the Composer aspect of routing chat interactions to Agent Groups. This example is based on a multimedia interaction (chat), which uses Composer's [Route Interaction block](#), Targets property. A voice interaction uses the [Target block](#) and properties, such as the Targets property. Once ORS/URS identify a routing target, [other servers](#) are involved in the process of delivering the interaction to the agent desktop.

[Link to video](#)

Debugging VoiceXML Applications

Below is a video tutorial on [debugging VoiceXML applications](#).

Important

While the interface for Composer in this video is from release 8.0.1, the steps are basically the same for subsequent releases.

[Link to video](#)

Deploying a Composer Application to a Web Server

Below is a video tutorial on exporting and [deploying a Composer application](#) to a web server.

Important

While the interface for Composer in this video is from release 8.0.1, the steps are basically the same for subsequent releases.

[Link to video](#)

Using the Database Blocks

Below is a video tutorial on using the [Database Blocks](#).

Important

While the interface for Composer in this video is from release 8.0.1, the steps are basically the same for subsequent releases.

[Link to video](#)

Creating a Simple Grammar

Below is a video tutorial on [building a simple grammar with the Grammar Menu block](#).

Important

While the interface for Composer in this video is from release 8.0.1, the steps are basically the same for subsequent releases.

[Link to video](#)

Using the Web Service Block

Below is a video tutorial on using the Web Service block.

Tip

While the interface for Composer in this video is from release 8.0.1, the steps are the basically the same for subsequent releases.

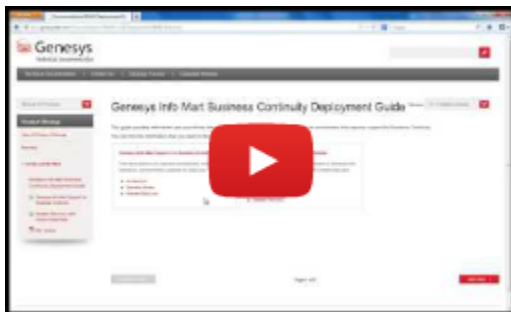

Refactoring Variables

Below is a video tutorial on automatically refactoring variables.

Important

This feature is available from version 8.1.450.33 only.

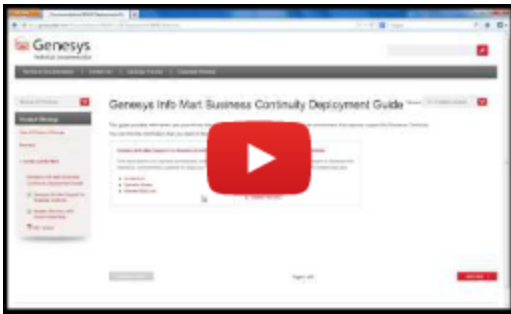

Using Bulk Manager

Below is a video tutorial on using the Bulk Manager wizard.

Important

This feature is available from version 8.1.450.33 only.

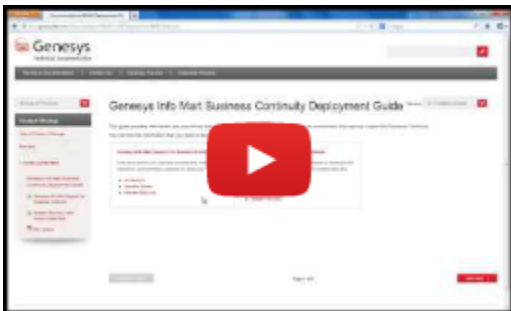

Creating a Java Composer Maven Project

Below is a microvideo on creating a Java Composer Maven Project.

Important

Maven support is available from version 8.1.550.08 only.

[Link to video](#)

Masking Sensitive Information in Composer Tomcat Logs

Below is a microvideo on masking sensitive information in Tomcat Logs.

Important

This feature is available from version 8.1.550.08 only.

[Link to video](#)

Configuring Log Levels for Server-Side Blocks

Below is a video that shows you how to configure log levels for server-side blocks using the Bulk Manager.

Important

This feature is available from version 8.1.550.03 only.

[Link to video](#)